

# KAF-16801

## 4096 (H) x 4096 (V) Full Frame CCD Image Sensor

### Description

The KAF-16801 is a high performance area CCD (charge-coupled device) image sensor with 4096 (H) x 4096 (V) photo active pixels designed for a wide range of image sensing applications.

The sensor incorporates true two-phase CCD technology, simplifying the support circuits required to drive the sensor as well as reducing dark current without compromising charge capacity. The sensor also utilizes the TRUESENSE Transparent Gate Electrode to improve sensitivity compared to the use of a standard front side illuminated polysilicon electrode.

**Table 1. GENERAL SPECIFICATIONS**

Parameter	Typical Value
Architecture	Full Frame CCD
Pixel Count	4096 (H) x 4096 (V)
Pixel Size	9.0 $\mu\text{m}$ (H) x 9.0 $\mu\text{m}$ (V)
Active Image Size	36.88 mm (H) x 36.88 mm (V) 52.1 mm (Diagonal) 645 1.3x Optical Format
Chip Size	38.60 mm (H) x 37.76 mm (V)
Optical Fill Factor	100%
Saturation Signal	100,000 electrons
Output Sensitivity	13 $\mu\text{V}/\text{e}^-$
Dark Current (Accumulation Model)	< 10 pA/cm <sup>2</sup>
Dark Current Doubling Rate	6°C
Dynamic Range (Saturation Signal/Dark Noise)	76 dB
Quantum Efficiency (450, 550, 650 nm)	40%, 52%, 65%
Maximum Data Rate	10 MHz
Package	CERDIP Package (Sidebrazed)
Cover Glass	Clear

NOTE: Parameters above are specified at T = 25°C unless otherwise noted.



**ON Semiconductor®**

[www.onsemi.com](http://www.onsemi.com)

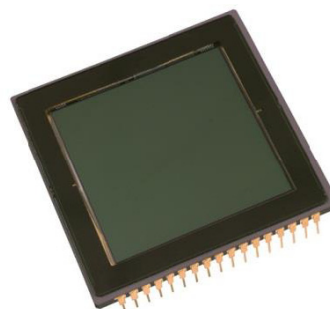

**Figure 1. KAF-16801 Full Frame CCD Image Sensor**

### Features

- True Two Phase Full Frame Architecture
- TRUESENSE Transparent Gate Electrode for High Sensitivity
- Low Dark Current
- High Output Sensitivity

### Application

- Scientific Imaging

### ORDERING INFORMATION

See detailed ordering and shipping information on page 2 of this data sheet.

# KAF-16801

## ORDERING INFORMATION

**Table 2. ORDERING INFORMATION – KAF-16801 IMAGE SENSOR**

Part Number	Description	Marking Code
KAF-16801-AAA-DP-B1	Monochrome, No Microlens, CERDIP Package (Sidebrazed, CuW), Taped Clear Cover Glass (No Coatings), Grade 1	KAF-16801-AAA Serial Number
KAF-16801-AAA-DP-B2	Monochrome, No Microlens, CERDIP Package (Sidebrazed, CuW), Taped Clear Cover Glass (No Coatings), Grade 2	
KAF-16801-AAA-DP-AE	Monochrome, No Microlens, CERDIP Package (Sidebrazed, CuW), Taped Clear Cover Glass (No Coatings), Engineering Sample	

**Table 3. ORDERING INFORMATION – EVALUATION SUPPORT**

Part Number	Description
KEK-4H0082-KAF-160801-12-5	Evaluation Board (Complete Kit)

See the ON Semiconductor *Device Nomenclature* document (TND310/D) for a full description of the naming convention used for image sensors. For reference documentation, including information on evaluation kits, please visit our web site at [www.onsemi.com](http://www.onsemi.com).

DEVICE DESCRIPTION

Architecture

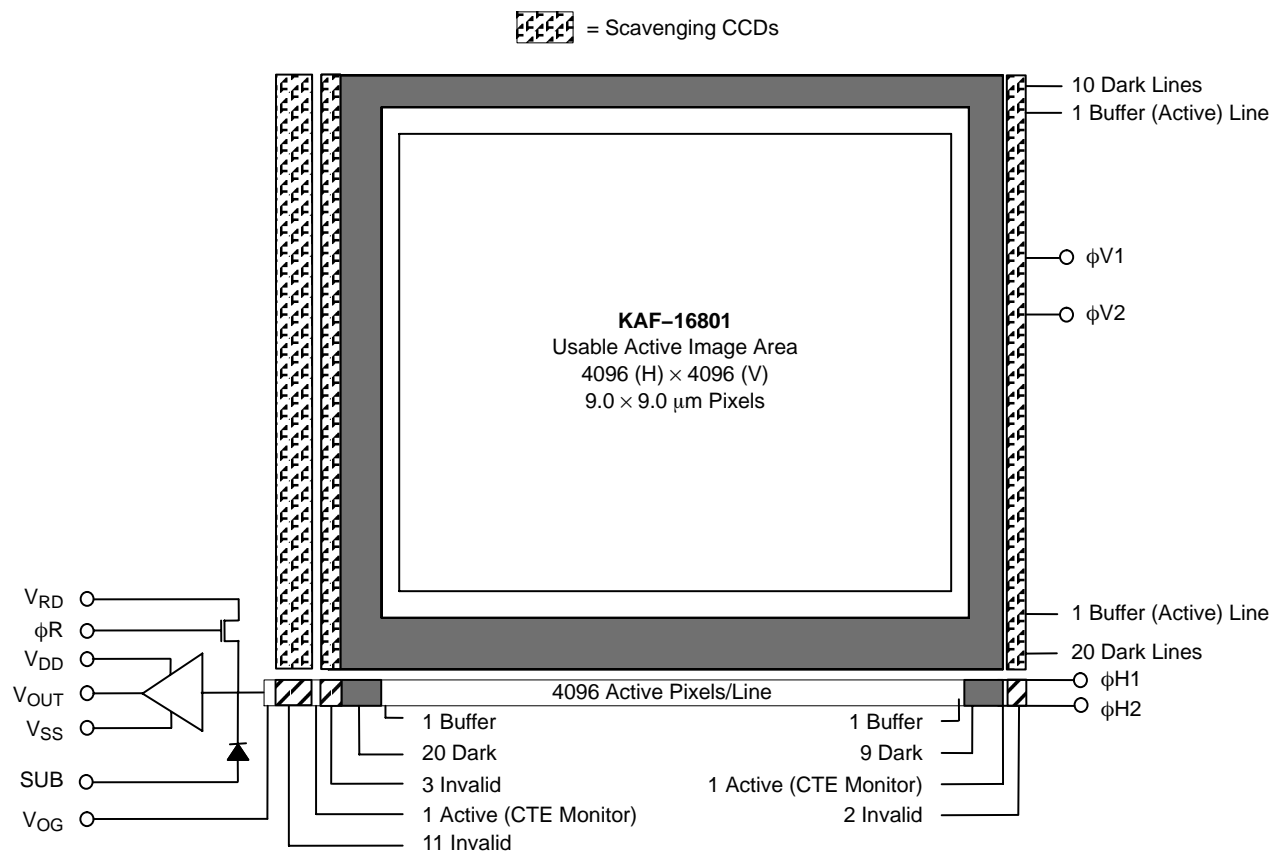

Figure 2. Block Diagram

The sensor consists of 4,127 parallel (vertical) CCD shift registers each 4,128 elements long. These registers act as both the photosensitive elements and as the transport circuits that allow the image to be sequentially read out of the sensor. The elements of these registers are arranged into a 4096 × 4096 photosensitive array surrounded by a light shielded dark reference of 29 columns and 30 rows. There is a buffer region of one photosensitive pixel surrounding the photosensitive region (one column at the beginning of a line, one column at the end of a line, one row at the beginning of a frame, and one row at the end of a frame). The parallel (vertical) CCD registers transfer the image one line at a time into a single 4,145 element (horizontal) CCD shift register. The horizontal register transfers the charge to a single output amplifier. The output amplifier is a three-stage source follower that converts the photo-generated charge to a voltage for each pixel.

*Dark Reference Pixels*

Surrounding the periphery of the device is a border of light shielded pixels. This includes 20 leading and 10 trailing pixels on every line excluding the inactive and photosensitive buffer pixels. There are also 20 full dark lines at the start of every frame and 10 full dark lines at the end of each frame. Under normal circumstances, these dark reference pixels do not respond to light. However, the pixels in close proximity to an active pixel can scavenge signal depending on light intensity and wavelength and therefore will not represent the true dark signal.

*Output Structure*

Charge presented to the floating diffusion (FD) is converted into a voltage and current amplified in order to drive off-chip loads. The resulting voltage change seen at the output is linearly related to the amount of charge placed on

FD. Once the signal has been sampled by the system electronics, the reset gate ( $\phi R$ ) is clocked to remove the signal and FD is reset to the potential applied by  $V_{RD}$ . More signal at the floating diffusion reduces the voltage seen at the output pin. In order to activate the output structure, an off-chip load must be added to the  $V_{OUT}$  pin of the device – see Figure 3.

#### Transfer Efficiency Test Pixels and Dummy Pixels

At the beginning of each line and at the end of each line are extra horizontal CCD pixels. These are a combination of pixels that are not associated with any vertical CCD register and two that are associated with extra photo active vertical CCDs. The two extra photo active vertical CCDs are provided to give an accurate photo generated signal that can be used to monitor the charge transfer efficiency in the serial (horizontal) register.

They are arranged as follows beginning with the first pixel in each line:

- 11 Dark, Inactive Pixels
- 1 Photoactive Test Pixel
- 3 Inactive Pixels
- 20 Dark Reference Pixels
- 1 Active Buffer Pixel
- 4,096 Photoactive Pixels
- 1 Active Buffer Pixel
- 9 Dark Reference Pixels
- 1 Photoactive Test Pixel
- 2 Inactive Pixels

#### Image Acquisition

An electronic representation of an image is formed when incident photons falling on the sensor plane create electron-hole pairs within the sensor. These photon-induced electrons are collected locally by the formation of potential wells at each photogate or pixel site. The number of electrons collected is linearly dependent on light level and exposure time and non-linearly dependent on wavelength. When the pixel's capacity is reached, excess electrons will leak into the adjacent pixels within the same column. This is termed blooming. During the integration period, the  $\phi V1$  and  $\phi V2$  register clocks are held at a constant (low) level. See Figure 8.

#### Charge Transport

Referring again to Figure 8 – Timing Diagrams, the integrated charge from each photogate is transported to the output using a two-step process. Each line (row) of charge is first transported from the vertical CCDs to the horizontal CCD register using the  $\phi V1$  and  $\phi V2$  register clocks. The horizontal CCD is presented a new line on the falling edge of  $\phi V1$  while  $\phi H2$  is held high. The horizontal CCDs then transport each line, pixel by pixel, to the output structure by alternately clocking the  $\phi H1$  and  $\phi H2$  pins in a complementary fashion. On each falling edge of  $\phi H1$  a new charge packet is transferred onto a floating diffusion and sensed by the output amplifier.

#### Horizontal Register

##### Output Structure

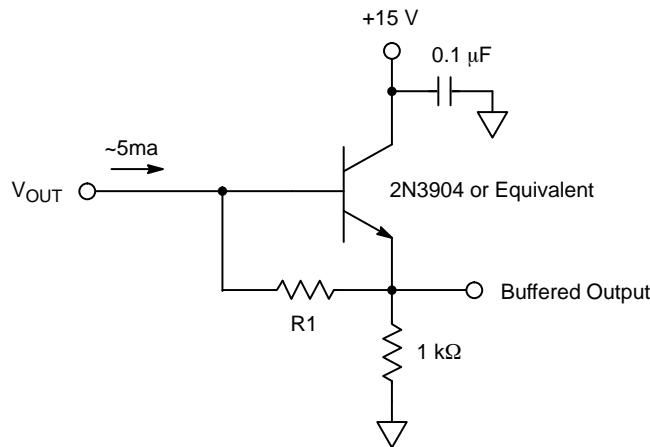

#### Notes:

1. For operation of up to 10 MHz.
2. The value of  $R1$  depends on the desired output current according the following formula:  $R1 = 0.7 / I_{OUT}$ .
3. The optimal output current depends on the capacitance that needs to be driven by the amplifier and the bandwidth required. 5 mA is recommended for capacitance of 12 pF and pixel rates up to 20 MHz.

Figure 3. Output Structure Load Diagram

**Physical Description**

*Pin Description and Device Orientation*

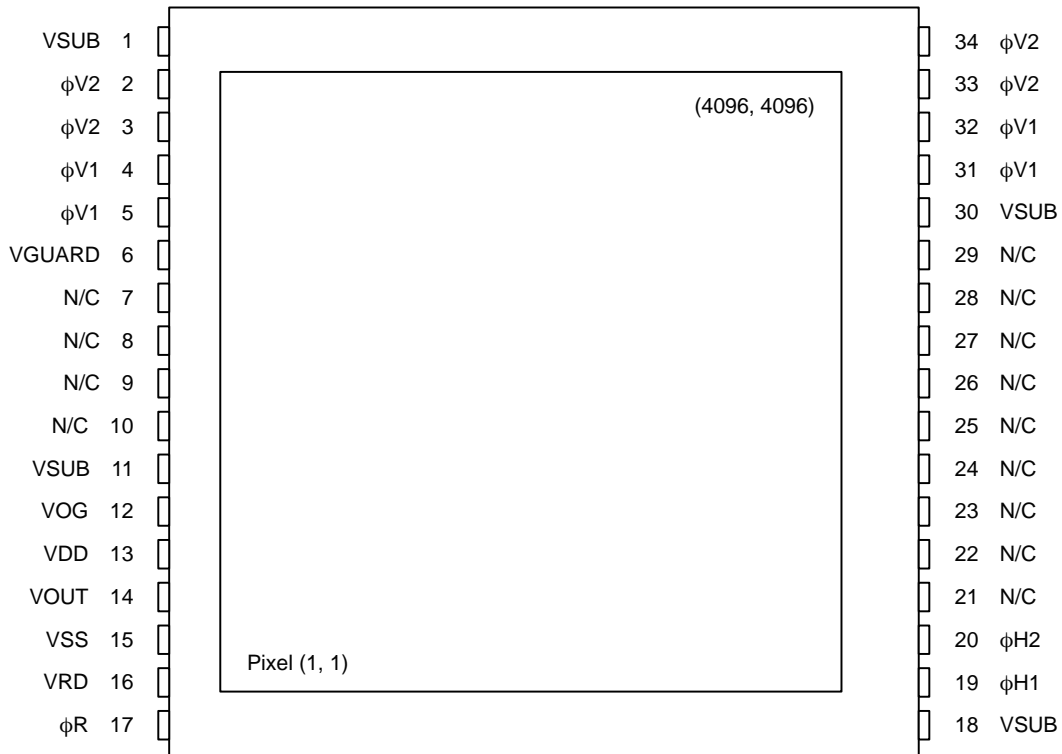

**Figure 4. Pinout Diagram**

**Table 4. PIN DESCRIPTION**

Pin	Name	Description
1	VSUB	Substrate (Ground)
2	$\phi V2$	Vertical CCD Clock – Phase 2
3	$\phi V2$	Vertical CCD Clock – Phase 2
4	$\phi V1$	Vertical CCD Clock – Phase 1
5	$\phi V1$	Vertical CCD Clock – Phase 1
6	VGUARD	Guard Ring
7	N/C	No Connection (Open Pin)
8	N/C	No Connection (Open Pin)
9	N/C	No Connection (Open Pin)
10	N/C	No Connection (Open Pin)
11	VSUB	Substrate (Ground)
12	VOG	Output Gate
13	VDD	Amplified Supply
14	VOUT	Video Output
15	VSS	Amplifier Supply Return
16	VRD	Reset Drain
17	$\phi R$	Reset Clock

Pin	Name	Description
18	VSUB	Substrate (Ground)
19	$\phi H1$	Horizontal CCD Clock – Phase 1
20	$\phi H2$	Horizontal CCD Clock – Phase 2
21	N/C	No Connection (Open Pin)
22	N/C	No Connection (Open Pin)
23	N/C	No Connection (Open Pin)
24	N/C	No Connection (Open Pin)
25	N/C	No Connection (Open Pin)
26	N/C	No Connection (Open Pin)
27	N/C	No Connection (Open Pin)
28	N/C	No Connection (Open Pin)
29	N/C	No Connection (Open Pin)
30	VSUB	Substrate (Ground)
31	$\phi V1$	Vertical CCD Clock – Phase 1
32	$\phi V1$	Vertical CCD Clock – Phase 1
33	$\phi V2$	Vertical CCD Clock – Phase 2
34	$\phi V2$	Vertical CCD Clock – Phase 2

## IMAGING PERFORMANCE

**Table 5. TYPICAL OPERATIONAL CONDITIONS**

(All values measured at 25°C, and nominal operating conditions. These parameters exclude defective pixels.)

Description	Symbol	Min.	Nom.	Max.	Units	Notes	Verification Plan
Saturation Signal Vertical CCD Capacity Horizontal CCD Capacity Output Node Capacity	$N_{SAT}$	– 90,000 –	100,000 200,000 180,000	100,000 – 250,000	$e^-/pix$	1	Design <sup>12</sup>
Photoresponse Non-Linearity	PRNL	–	1	2	%	2	Design <sup>12</sup>
Photoresponse Non-Uniformity	PRNU	–	1	3	%	3, 10	Die <sup>11</sup>
Dark Signal	$J_{DARK}$	– –	18 3.5	50 10	$e^-/pix/sec$ $\mu A/cm^2$	4	Die <sup>11</sup>
Dark Signal Doubling Temperature		5	6.3	7.5	°C		Design <sup>12</sup>
Dark Signal Non-Uniformity	DSNU	–	18	50	$e^-/pix/sec$	5, 10	Die <sup>11</sup>
Dynamic Range	DR	73	76	–	dB	6	Design <sup>12</sup>
Charge Transfer Efficiency	CTE	0.99997	0.99999	–			Die <sup>11</sup>
Output Amplifier DC Offset	$V_{ODC}$	$V_{RD} - 3.0$	$V_{RD} - 2.5$	$V_{RD} - 2.0$	V	7	Die <sup>11</sup>
Output Amplifier Bandwidth	$f_{-3dB}$	–	140	–	MHz	8	Design <sup>12</sup>
Output Amplifier Sensitivity	$V_{OUT}/N_{e^-}$	12.5	13	14	$\mu V/e^-$		Design <sup>12</sup>
Output Amplifier Output Impedance	$Z_{OUT}$	–	130	–	$\Omega$		Design <sup>12</sup>
Noise Floor	$n_{e^-}$	–	15	20	electrons	9	Die <sup>11</sup>

1. For pixel binning applications, electron capacity up to 270,000 can be achieved with modified CCD inputs. Each sensor may have to be optimized individually for these applications. Some performance parameters may be compromised to achieve the largest signals.
2. Worst case deviation from straight line fit, between 1% and 90% of  $V_{SAT}$ .
3. One Sigma deviation of a  $128 \times 128$  sample when CCD illuminated uniformly.
4. Average of all pixels with no illumination at 25°C.
5. Average dark signal of any of  $32 \times 32$  blocks within the sensor (each block is  $128 \times 128$  pixels).
6.  $20\log(N_{SAT} / n_{e^-})$  at nominal operating frequency and 25°C.
7. Video level offset with respect to ground.
8. Assumes 10 pF off-chip load.
9. Output amplifier noise at 25°C, operating at pixel frequency up to 2 MHz, bandwidth = 20 MHz,  $t_{INT} = 0$ , and no dark current shot noise.
10. Specification excludes region [1, 1, 400, 400]. See Dark Current Non-uniformity.
11. A parameter that is measured on every sensor during production testing.
12. A parameter that is quantified during the design verification activity.

## TYPICAL PERFORMANCE CURVES

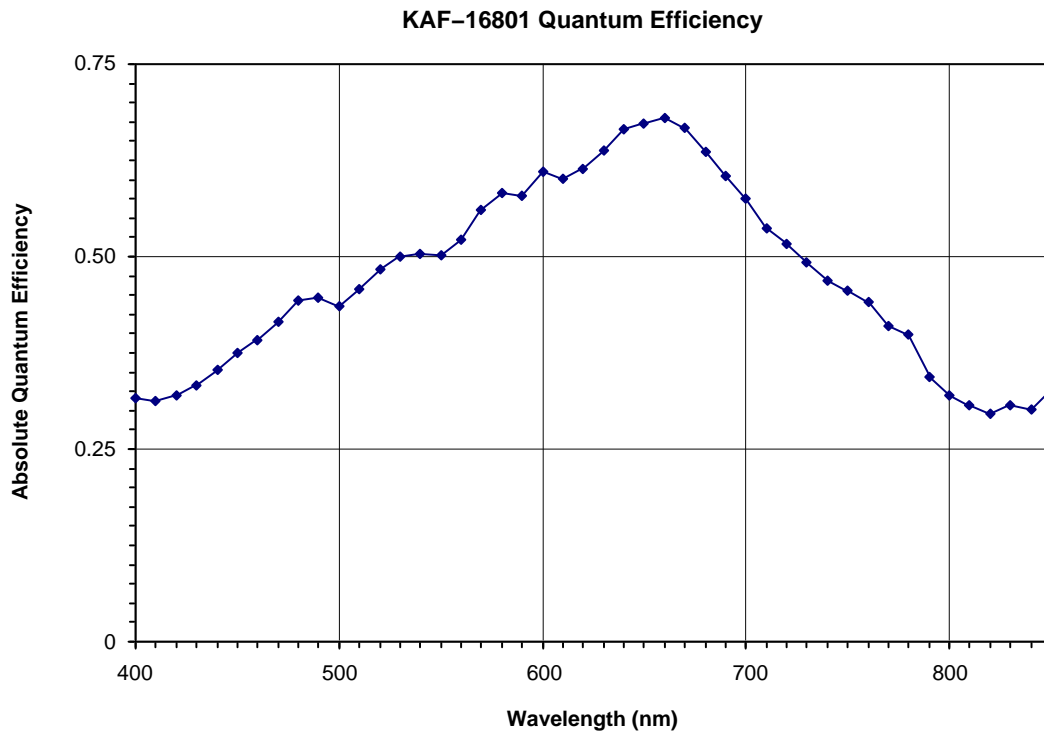

Figure 5. Typical Spectral Response

*Dark Current Non-Uniformity*

The photoresponse non-uniformity specification and the dark signal non-uniformity specification of the sensor both exclude the region that is [1, 1, 400, 400]. The reason for this exclusion is that when the sensor is running with  $V_{DD}$  always on, and the integration times are greater than 100 msec, a non-uniformity will become evident surrounding the first pixel. This non-uniformity is a result of

the output amplifier emitting light into the photoactive area (see Figure 9). The elevated dark signal in this region typically ranges from  $30 e^-/\text{pix}/\text{sec}$  to  $100 e^-/\text{pix}/\text{sec}$ , depending on the part, and is independent of temperature. If  $V_{DD}$  is switched to 0 V at least 10  $\mu\text{sec}$  after the last pixel is read out, and switched back to full value 10  $\mu\text{sec}$  before the first pixel of the next frame, the effect of the amplifier glow will be eliminated (see Figure 10).

**DEFECT DEFINITIONS**

**Table 6. SPECIFICATIONS** (All defect tests performed at T = 25°C)

Classification	Point Defects	Cluster Defects	Maximum Cluster Size	Column Defects	Maximum Column Width
C1	≤ 60	≤ 8	8	4	1
C2	≤ 120	≤ 16	8	10	1
C3	≤ 240	≤ 32	15	20	2

*Point Defects*

Dark: A pixel which deviates by more than 6% from neighboring pixels when illuminated to 70% of saturation.

Bright: A pixel with a dark current > 7,000 e<sup>-</sup>/pixel/sec at 25°C.

*Cluster Defect*

A grouping of not more than 5 adjacent point defects.

*Column Defect*

A grouping of > 5 contiguous point defects along a single column.

A column containing a pixel with dark current > 20,000 e<sup>-</sup>/pixel/sec.

A column that does not meet the CTE specification for all exposures less than the specified Max sat. signal level and greater than 2 ke<sup>-</sup>.

A column which contains a pixel that loses > 250 e<sup>-</sup> under 2 ke<sup>-</sup> illumination.

*Neighboring Pixels*

The surrounding 128 × 128 pixels or ±64 columns/rows.

*Defect Separation*

Column and cluster defects are separated by no less than 2 pixels in any direction (excluding single pixel defects).

*Defect Region Exclusion*

Defect region excludes the outer 2 rows and columns at each side/end of the sensor.

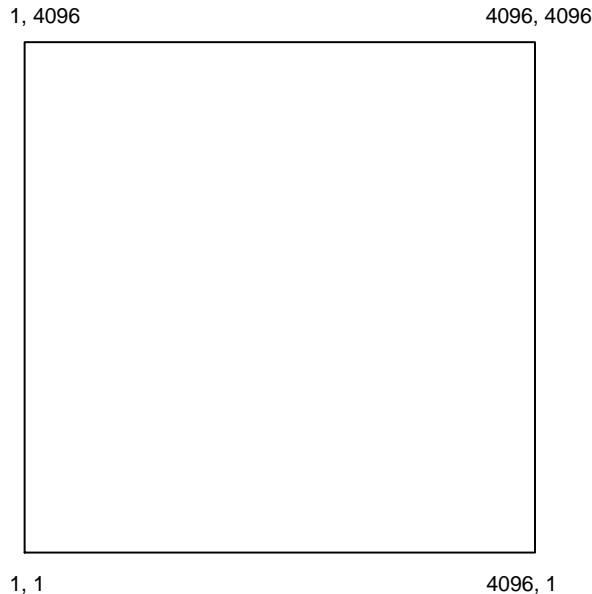

**Figure 6. Active Pixel Region**



## OPERATION

Table 7. ABSOLUTE MAXIMUM RATINGS

Description	Symbol	Minimum	Maximum	Units	Notes
Diode Pin Voltages	$V_{DIODE}$	0	20	V	1, 2
Gate Pin Voltages – Type 1	$V_{GATE1}$	-16	16	V	1, 3
Gate Pin Voltages – Type 2	$V_{GATE2}$	0	16	V	1, 4
Inter-Gate Voltages	$V_{G-G}$	-	16	V	5
Output Bias Current	$I_{OUT}$	-	-10	mA	6
Output Load Capacitance	$C_{LOAD}$	-	15	pF	6
Storage Temperature	T	-50	70	°C	
Humidity	RH	5	90	%	7

Stresses exceeding those listed in the Maximum Ratings table may damage the device. If any of these limits are exceeded, device functionality should not be assumed, damage may occur and reliability may be affected.

1. Referenced to pin VSUB.
2. Includes pins: VRD, VDD, VSS, VOUT, VGUARD.
3. Includes pins:  $\phi V1$ ,  $\phi V2$ ,  $\phi H1$ ,  $\phi H2$ .
4. Includes pins:  $\phi R$ , VOG.
5. Voltage difference between overlapping gates. Includes:  $\phi V1$  to  $\phi V2$ ,  $\phi H1$  to  $\phi H2$ ,  $\phi V1$  to  $\phi H2$ ,  $\phi H1$  to VOG.
6. Avoid shorting output pins to ground or any low impedance source during operation.
7. T = 25°C. Excessive humidity will degrade MTF.

Table 8. DC BIAS OPERATING CONDITIONS

Description	Symbol	Minimum	Nominal	Maximum	Units	Maximum DC Current (mA)	Notes
Reset Drain	$V_{RD}$	11.0	12.0	12.25	V	0.01	
Output Amplifier Return	$V_{SS}$	1.5	2.0	2.5	V	0.45	
Output Amplifier Supply	$V_{DD}$	14.5	15.0	17.0	V	$I_{OUT}$	
Substrate	$V_{SUB}$	0	0	0	V	0.01	
Output Gate	$V_{OG}$	4.5	5.0	5.2	V	0.01	
Guard Ring	$V_{LG}$	9.0	10.0	12.0	V	0.01	
Video Output Current	$I_{OUT}$	-3.5	-5.0	-10.0	mA		1

1. An output load sink must be applied to  $V_{OUT}$  to activate output amplifier – see Figure 3.

## AC Operating Conditions

Table 9. CLOCK LEVELS

Description	Symbol	Level	Minimum	Nominal	Maximum	Units	Effective Capacitance
Vertical CCD Clock – Phase 1	$\phi V1$	Low	-9.0	-8.5	-8.3	V	250 nF (All $\phi V1$ Pins)
Vertical CCD Clock – Phase 1	$\phi V1$	High	$\phi V1$ Low + 10.5	2.0	$\phi V1$ Low + 10.5	V	250 nF (All $\phi V1$ Pins)
Vertical CCD Clock – Phase 2	$\phi V2$	Low	-9.0	-8.5	-8.3	V	250 nF (All $\phi V2$ Pins)
Vertical CCD Clock – Phase 2	$\phi V2$	High	$\phi V2$ Low + 10.5	2.0	$\phi V2$ Low + 10.5	V	250 nF (All $\phi V2$ Pins)
Horizontal CCD Clock – Phase 1	$\phi H1$	Low	-2.5	-2.5	-1.8	V	500 pF
Horizontal CCD Clock – Phase 1	$\phi H1$	High	$\phi H1$ Low + 10.5	2.0	$\phi H1$ Low + 10.5	V	500 pF
Horizontal CCD Clock – Phase 2	$\phi H2$	Low	-2.5	-2.5	-1.8	V	300 pF
Horizontal CCD Clock – Phase 2	$\phi H2$	High	$\phi H2$ Low + 10.5	2.0	$\phi H2$ Low + 10.5	V	300 pF
Reset Clock	$\phi R$	Low	3.0	5.0	5.5	V	10 pF
Reset Clock	$\phi R$	High	9.5	10.0	10.5	V	10 pF

1. All pins draw less than 10  $\mu$ A DC current.
2. Capacitance include gate to  $V_{SUB}$  and gate to gate ( $\phi V1$ - $\phi V2$ ,  $\phi H1$ - $\phi H2$ ).

**TIMING**

**Table 10. REQUIREMENTS AND CHARACTERISTICS**

Description	Symbol	Minimum	Nominal	Maximum	Units	Notes
$\phi$ H1, $\phi$ H2 Clock Frequency	$f_H$	–	8	15	MHz	1, 2, 3
$\phi$ V1, $\phi$ V2 Clock Frequency	$F_V$	–	25	25	MHz	1, 2, 3
Pixel Period (1 Count)	$t_e$	67	125	–	ns	
$\phi$ H1, $\phi$ H2 Set-up Time	$t_{\phi HS}$	0.5	1	–	$\mu$ s	
$\phi$ V1, $\phi$ V2 Clock Pulse Width	$t_{\phi V}$	40	40	–	$\mu$ s	2
$\phi$ V1, $\phi$ V2 Clock Pulse Overlap	$t_{OVRLP}$	20	20	–	$\mu$ s	
Reset Clock Width	$t_{\phi R}$	10	20	–	ns	4
Readout Time	$t_{READOUT}$	1,398	2,390	–	ms	5
Integration Time	$t_{INT}$	–	–	–		6
Line Time	$t_{LINE}$	338.7	580	–	$\mu$ s	7

1. 50% duty cycle values.
2. CTE may degrade above the nominal frequency.
3. Rise and fall times (10/90% levels) should be limited to 5–10% of clock period. Cross-over of register clocks should be between 40–60% of amplitude.
4.  $\phi$ R should be clocked continuously.
5.  $t_{READOUT} = (4128 \cdot t_{LINE})$
6. Integration time is user specified. Longer integration times will degrade noise performance.
7.  $t_{LINE} = (2 \cdot t_{\phi V}) - t_{OVRLP} + t_{\phi HS} + (4145 \cdot t_e) + t_e$ .

**Frame Timing**

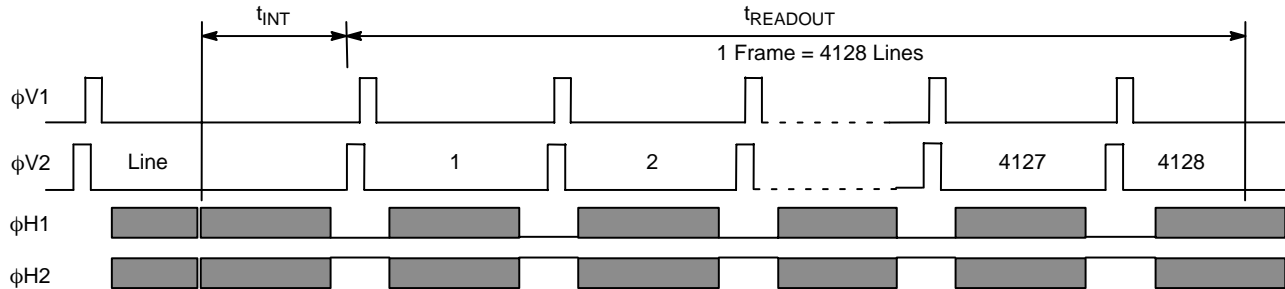

**Figure 7. Frame Timing Diagram**

Line Timing and Pixel Timing

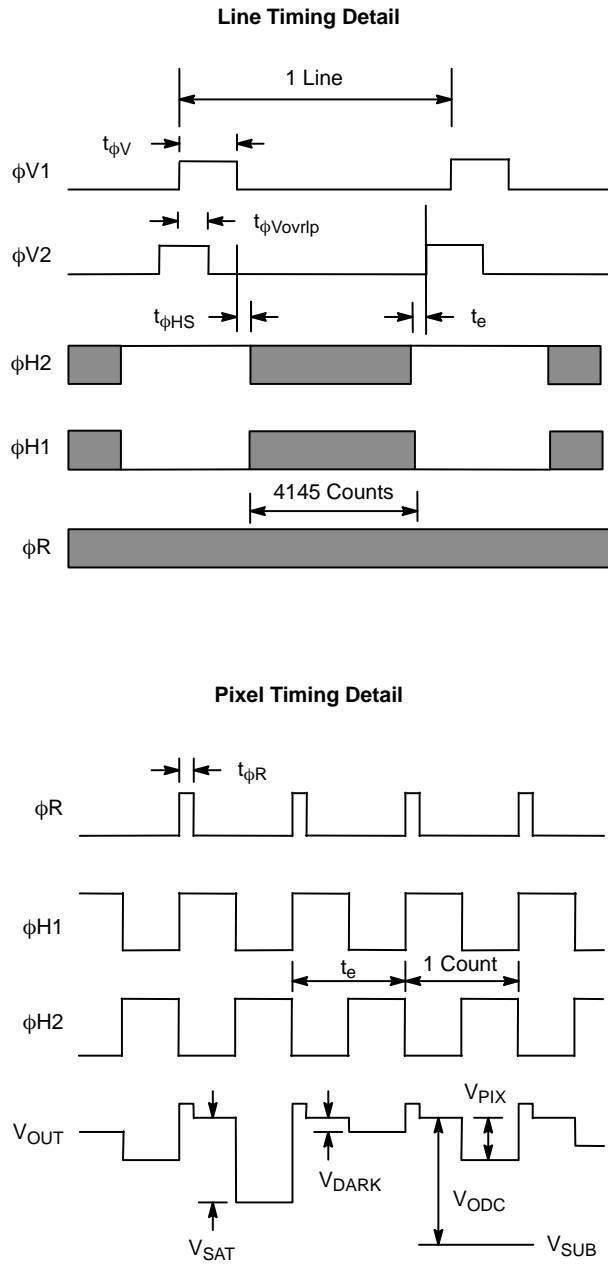
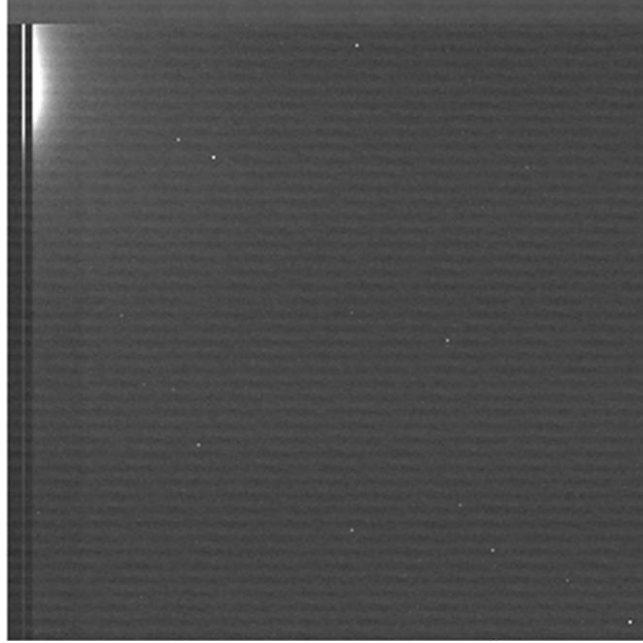
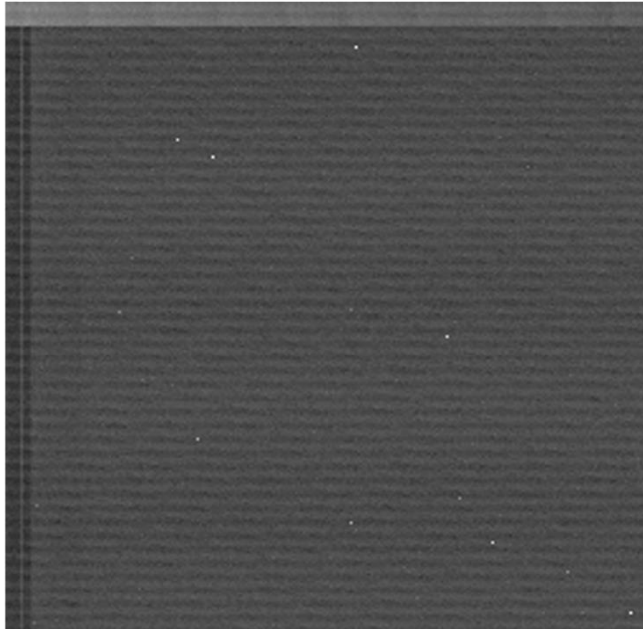

Figure 8. Line Timing and Pixel Timing



**Figure 9. Amplifier Glow – S11LE @-20C with 20 sec Integration @1 MHz  
 $V_{DD}$  always ON (+15)**



**Figure 10. Amplifier Glow – S11LE @-20C with 20 sec Integration @1 MHz  
 $V_{DD}$  OFF during Integration**

NOTE: Amplifier glow is suppressed by switching  $V_{DD}$  to 0 V during integration.

## STORAGE AND HANDLING

Table 11. STORAGE CONDITIONS

Description	Symbol	Minimum	Maximum	Units	Notes
Storage Temperature	T <sub>ST</sub>	-20	100	°C	1
Operating Temperature	T <sub>OP</sub>	-60	60	°C	

1. Storage toward the maximum temperature will accelerate microlens degradation.

For information on ESD and cover glass care and cleanliness, please download the *Image Sensor Handling and Best Practices* Application Note (AN52561/D) from [www.onsemi.com](http://www.onsemi.com).

For information on soldering recommendations, please download the *Soldering and Mounting Techniques Reference Manual* (SOLDERRM/D) from [www.onsemi.com](http://www.onsemi.com).

For quality and reliability information, please download the *Quality & Reliability Handbook* (HBD851/D) from [www.onsemi.com](http://www.onsemi.com).

For information on device numbering and ordering codes, please download the *Device Nomenclature* technical note (TND310/D) from [www.onsemi.com](http://www.onsemi.com).

For information on Standard terms and Conditions of Sale, please download [Terms and Conditions](http://www.onsemi.com) from [www.onsemi.com](http://www.onsemi.com).

MECHANICAL INFORMATION

Completed Assembly

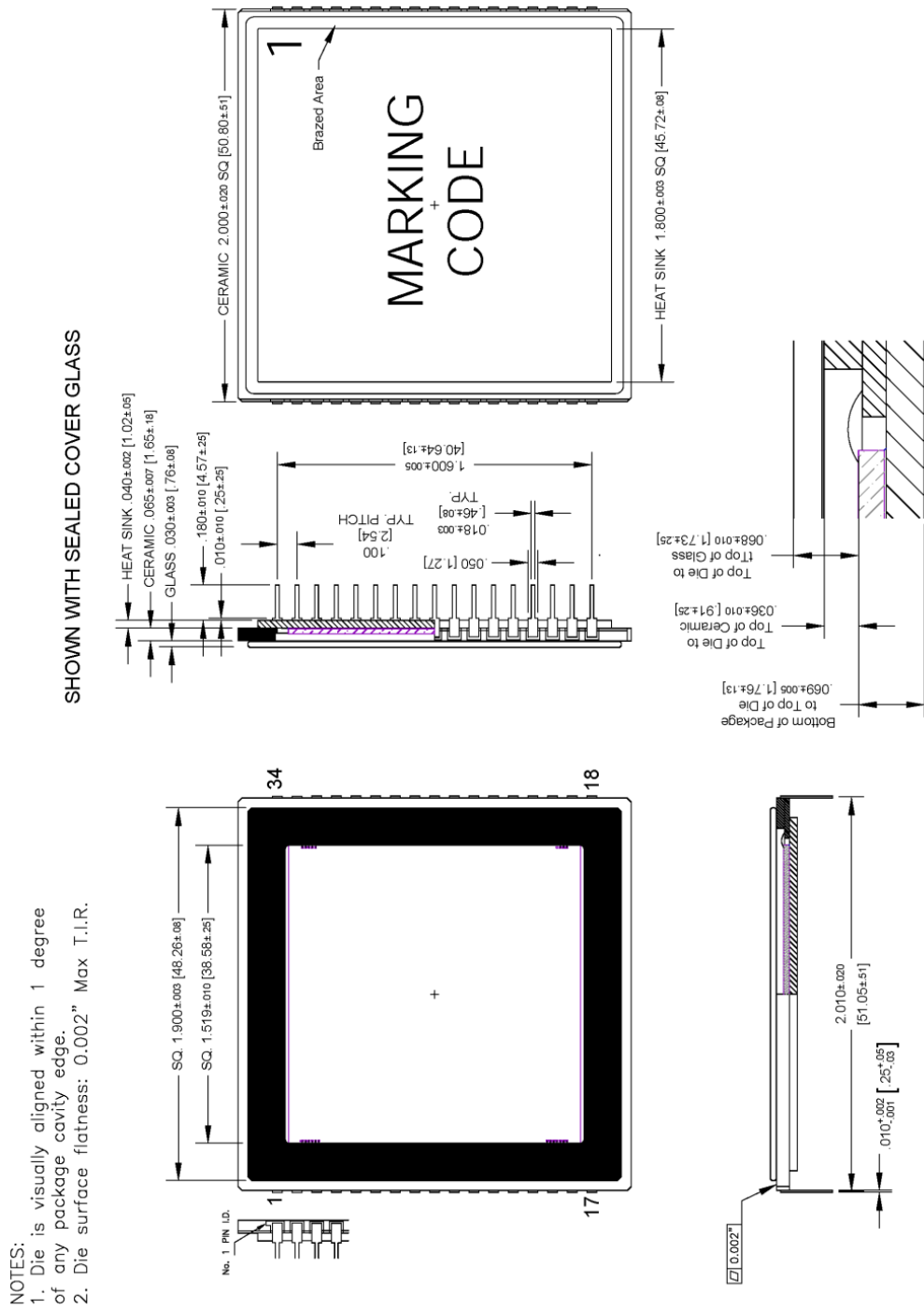

Figure 11. Completed Assembly (1 of 2)

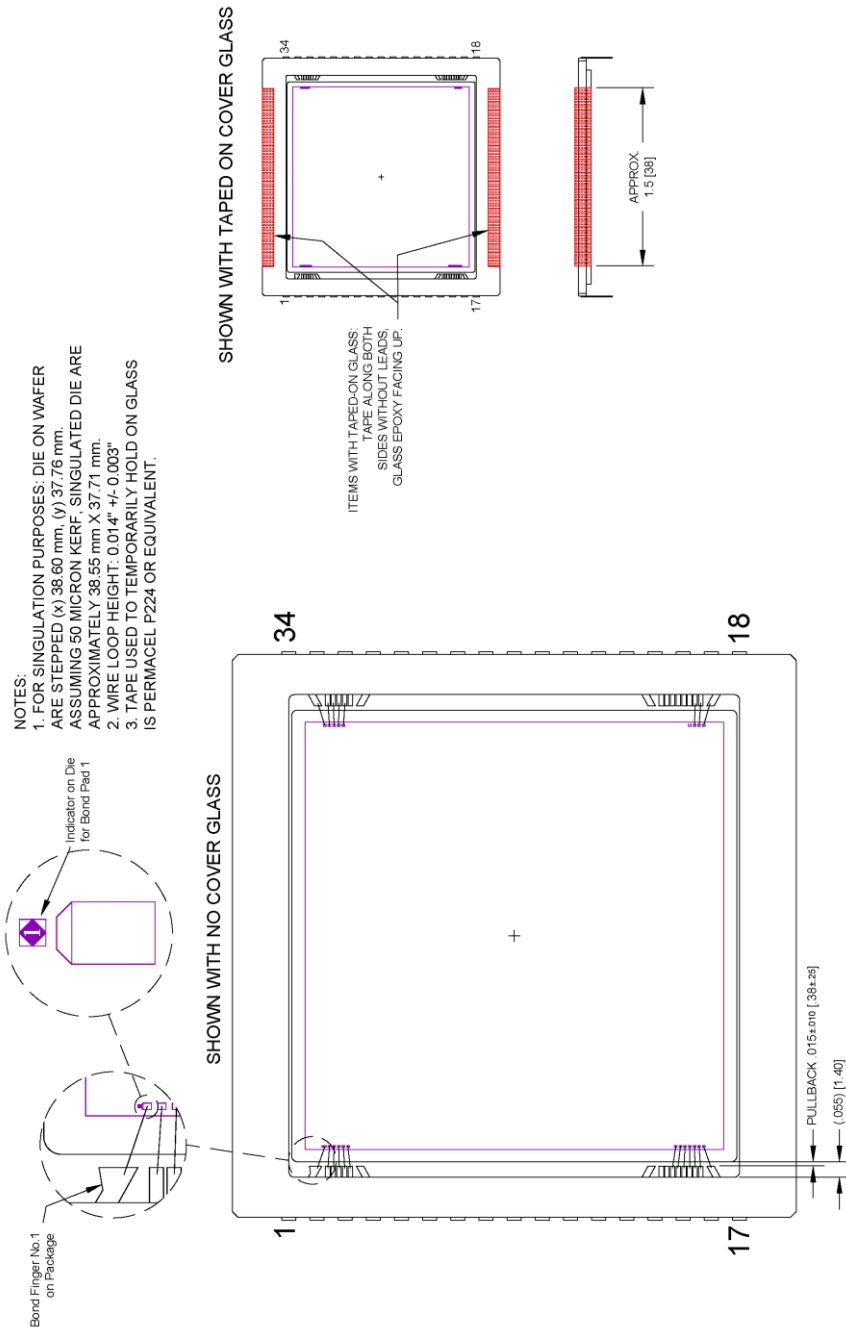

Figure 12. Completed Assembly (2 of 2)

ON Semiconductor and the  are registered trademarks of Semiconductor Components Industries, LLC (SCILLC) or its subsidiaries in the United States and/or other countries. SCILLC owns the rights to a number of patents, trademarks, copyrights, trade secrets, and other intellectual property. A listing of SCILLC's product/patent coverage may be accessed at [www.onsemi.com/site/pdf/Patent-Marking.pdf](http://www.onsemi.com/site/pdf/Patent-Marking.pdf). SCILLC reserves the right to make changes without further notice to any products herein. SCILLC makes no warranty, representation or guarantee regarding the suitability of its products for any particular purpose, nor does SCILLC assume any liability arising out of the application or use of any product or circuit, and specifically disclaims any and all liability, including without limitation special, consequential or incidental damages. "Typical" parameters which may be provided in SCILLC data sheets and/or specifications can and do vary in different applications and actual performance may vary over time. All operating parameters, including "Typicals" must be validated for each customer application by customer's technical experts. SCILLC does not convey any license under its patent rights nor the rights of others. SCILLC products are not designed, intended, or authorized for use as components in systems intended for surgical implant into the body, or other applications intended to support or sustain life, or for any other application in which the failure of the SCILLC product could create a situation where personal injury or death may occur. Should Buyer purchase or use SCILLC products for any such unintended or unauthorized application, Buyer shall indemnify and hold SCILLC and its officers, employees, subsidiaries, affiliates, and distributors harmless against all claims, costs, damages, and expenses, and reasonable attorney fees arising out of, directly or indirectly, any claim of personal injury or death associated with such unintended or unauthorized use, even if such claim alleges that SCILLC was negligent regarding the design or manufacture of the part. SCILLC is an Equal Opportunity/Affirmative Action Employer. This literature is subject to all applicable copyright laws and is not for resale in any manner.

## PUBLICATION ORDERING INFORMATION

### LITERATURE FULFILLMENT:

Literature Distribution Center for ON Semiconductor  
P.O. Box 5163, Denver, Colorado 80217 USA  
**Phone:** 303-675-2175 or 800-344-3860 Toll Free USA/Canada  
**Fax:** 303-675-2176 or 800-344-3867 Toll Free USA/Canada  
**Email:** [orderlit@onsemi.com](mailto:orderlit@onsemi.com)

**N. American Technical Support:** 800-282-9855 Toll Free  
USA/Canada  
**Europe, Middle East and Africa Technical Support:**  
Phone: 421 33 790 2910  
**Japan Customer Focus Center**  
Phone: 81-3-5817-1050

**ON Semiconductor Website:** [www.onsemi.com](http://www.onsemi.com)  
**Order Literature:** <http://www.onsemi.com/orderlit>  
For additional information, please contact your local  
Sales Representative



## Данный компонент на территории Российской Федерации

### Вы можете приобрести в компании MosChip.

Для оперативного оформления запроса Вам необходимо перейти по данной ссылке:

<http://moschip.ru/get-element>

Вы можете разместить у нас заказ для любого Вашего проекта, будь то серийное производство или разработка единичного прибора.

В нашем ассортименте представлены ведущие мировые производители активных и пассивных электронных компонентов.

Нашей специализацией является поставка электронной компонентной базы двойного назначения, продукции таких производителей как XILINX, Intel (ex.ALTERA), Vicor, Microchip, Texas Instruments, Analog Devices, Mini-Circuits, Amphenol, Glenair.

Сотрудничество с глобальными дистрибьюторами электронных компонентов, предоставляет возможность заказывать и получать с международных складов практически любой перечень компонентов в оптимальные для Вас сроки.

На всех этапах разработки и производства наши партнеры могут получить квалифицированную поддержку опытных инженеров.

Система менеджмента качества компании отвечает требованиям в соответствии с ГОСТ Р ИСО 9001, ГОСТ РВ 0015-002 и ЭС РД 009

### Офис по работе с юридическими лицами:

105318, г.Москва, ул.Щербаковская д.3, офис 1107, 1118, ДЦ «Щербаковский»

Телефон: +7 495 668-12-70 (многоканальный)

Факс: +7 495 668-12-70 (доб.304)

E-mail: [info@moschip.ru](mailto:info@moschip.ru)

Skype отдела продаж:

moschip.ru

moschip.ru\_4

moschip.ru\_6

moschip.ru\_9