

FEATURES

- +1.8 V to +5.5 V Single Supply
- 2.5 Ω (Typ) On Resistance
- Low On-Resistance Flatness
- 3 dB Bandwidth >200 MHz
- Rail-to-Rail Operation
- 10-Lead μ SOIC Package
- Fast Switching Times
 - t_{ON} 20 ns
 - t_{OFF} 13 ns
- Typical Power Consumption (<0.01 μ W)
- TTL/CMOS Compatible

APPLICATIONS

- Battery Powered Systems
- Communication Systems
- Sample-and-Hold Systems
- Audio Signal Routing
- Data Acquisition System
- Video Switching

GENERAL DESCRIPTION

The ADG704 is a CMOS analog multiplexer, comprising four single channels. This multiplexer is designed on an advanced submicron process that provides low power dissipation yet gives high switching speed, low on resistance, low leakage currents and high bandwidths.

The on resistance profile is very flat over the full analog signal range. This ensures excellent linearity and low distortion when switching audio signals. Fast switching speed also makes the part suitable for video signal switching.

The ADG704 can operate from a single supply range of +1.8 V to +5.5 V, making it ideal for use in battery powered instruments and with the new generation of DACs and ADCs from Analog Devices.

The ADG704 switches one of four inputs to a common output, D, as determined by the 3-bit binary address lines, A0, A1 and EN. A Logic "0" on the EN pin disables the device.

Each switch of the ADG704 conducts equally well in both directions when ON. The ADG704 exhibits break-before-make switching action.

The ADG704 is available in 10-lead μ SOIC package.

FUNCTIONAL BLOCK DIAGRAM

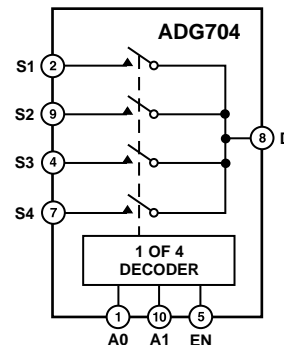

PRODUCT HIGHLIGHTS

1. +1.8 V to +5.5 V Single Supply Operation.
The ADG704 offers high performance and is fully specified and guaranteed with +3 V and +5 V supply rails.
2. Very Low R_{ON} (4.5 Ω Max at 5 V, 8 Ω Max at 3 V).
At supply voltage of +1.8 V, R_{ON} is typically 35 Ω over the temperature range.
3. Low On-Resistance Flatness.
4. -3 dB Bandwidth Greater than 200 MHz.
5. Low Power Dissipation.
CMOS construction ensures low power dissipation.
6. Fast t_{ON}/t_{OFF} .
7. Break-Before-Make Switching Action.
8. 10-Lead μ SOIC Package.

REV. A

Information furnished by Analog Devices is believed to be accurate and reliable. However, no responsibility is assumed by Analog Devices for its use, nor for any infringements of patents or other rights of third parties which may result from its use. No license is granted by implication or otherwise under any patent or patent rights of Analog Devices.

ADG704—SPECIFICATIONS¹ ($V_{DD} = +5\text{ V} \pm 10\%$, $GND = 0\text{ V}$. All Specifications -40°C to $+85^{\circ}\text{C}$, unless otherwise noted.)

Parameter	B Version		Units	Test Conditions/Comments
	+25°C	-40°C to +85°C		
ANALOG SWITCH				
Analog Signal Range		0 V to V_{DD}	V	$V_S = 0\text{ V}$ to V_{DD} , $I_{DS} = -10\text{ mA}$; Test Circuit 1
On-Resistance (R_{ON})	2.5		Ω typ	
	4	4.5	Ω max	
On-Resistance Match Between Channels (ΔR_{ON})		0.1	Ω typ	
		0.4	Ω max	$V_S = 0\text{ V}$ to V_{DD} , $I_{DS} = -10\text{ mA}$
On-Resistance Flatness ($R_{FLAT(ON)}$)	0.75		Ω typ	
		1.2	Ω max	$V_S = 0\text{ V}$ to V_{DD} , $I_{DS} = -10\text{ mA}$
LEAKAGE CURRENTS				
Source OFF Leakage I_S (OFF)	± 0.01		nA typ	$V_{DD} = +5.5\text{ V}$ $V_S = 4.5\text{ V}/1\text{ V}$, $V_D = 1\text{ V}/4.5\text{ V}$; Test Circuit 2
	± 0.1	± 0.3	nA max	
Drain OFF Leakage I_D (OFF)	± 0.01		nA typ	$V_S = 4.5\text{ V}/1\text{ V}$, $V_D = 1\text{ V}/4.5\text{ V}$; Test Circuit 2
	± 0.1	± 0.3	nA max	
Channel ON Leakage I_D , I_S (ON)	± 0.01		nA typ	$V_S = V_D = 4.5\text{ V}$ or 1 V ; Test Circuit 3
	± 0.1	± 0.3	nA max	
DIGITAL INPUTS				
Input High Voltage, V_{INH}		2.4	V min	$V_{IN} = V_{INL}$ or V_{INH}
Input Low Voltage, V_{INL}		0.8	V max	
Input Current				
I_{INL} or I_{INH}	0.005	± 0.1	μA typ μA max	
DYNAMIC CHARACTERISTICS²				
t_{ON}	14	20	ns typ ns max	$R_L = 300\ \Omega$, $C_L = 35\text{ pF}$ $V_S = 3\text{ V}$, Test Circuit 4
t_{OFF}	6	13	ns typ ns max	
Break-Before-Make Time Delay, t_D	8	1	ns typ ns min	$R_L = 300\ \Omega$, $C_L = 35\text{ pF}$ $V_S = 3\text{ V}$, Test Circuit 4
Charge Injection	3		pC typ	
Off Isolation	-60 -80		dB typ dB typ	$V_{S1} = V_{S2} = 3\text{ V}$, Test Circuit 5 $V_S = 2\text{ V}$, $R_S = 0\ \Omega$, $C_L = 1\text{ nF}$; Test Circuit 6
Channel-to-Channel Crosstalk	-62 -82		dB typ dB typ	
Bandwidth -3 dB	200		MHz typ	$R_L = 50\ \Omega$, $C_L = 5\text{ pF}$, $f = 10\text{ MHz}$ $R_L = 50\ \Omega$, $C_L = 5\text{ pF}$, $f = 1\text{ MHz}$; Test Circuit 7
C_S (OFF)	9		pF typ	
C_D (OFF)	37		pF typ	
C_D , C_S (ON)	54		pF typ	
POWER REQUIREMENTS				
I_{DD}	0.001	1.0	μA typ μA max	$V_{DD} = +5.5\text{ V}$ Digital Inputs = 0 V or 5 V

NOTES

¹Temperature ranges are as follows: B Version: -40°C to $+85^{\circ}\text{C}$.

²Guaranteed by design, not subject to production test.

Specifications subject to change without notice.

SPECIFICATIONS¹ ($V_{DD} = +3\text{ V} \pm 10\%$, $GND = 0\text{ V}$. All Specifications -40°C to $+85^{\circ}\text{C}$, unless otherwise noted.)

Parameter	B Version		Units	Test Conditions/Comments
	+25°C	-40°C to +85°C		
ANALOG SWITCH				
Analog Signal Range		0 V to V_{DD}	V	
On-Resistance (R_{ON})	4.5	5 8	Ω typ Ω max	$V_S = 0\text{ V}$ to V_{DD} , $I_{DS} = -10\text{ mA}$; Test Circuit 1
On-Resistance Match Between Channels (ΔR_{ON})	0.1		Ω typ Ω max	$V_S = 0\text{ V}$ to V_{DD} , $I_{DS} = -10\text{ mA}$
On-Resistance Flatness ($R_{FLAT(ON)}$)		0.4 2.5	Ω max Ω typ	$V_S = 0\text{ V}$ to V_{DD} , $I_{DS} = -10\text{ mA}$
LEAKAGE CURRENTS				
Source OFF Leakage I_S (OFF)	± 0.01		nA typ nA max	$V_{DD} = +3.3\text{ V}$ $V_S = 3\text{ V}/1\text{ V}$, $V_D = 1\text{ V}/3\text{ V}$; Test Circuit 2
Drain OFF Leakage I_D (OFF)	± 0.01	± 0.3	nA typ nA max	$V_S = 3\text{ V}/1\text{ V}$, $V_D = 1\text{ V}/3\text{ V}$; Test Circuit 2
Channel ON Leakage I_D , I_S (ON)	± 0.01	± 0.3	nA typ nA max	$V_S = V_D = 3\text{ V}$ or 1 V ; Test Circuit 3
DIGITAL INPUTS				
Input High Voltage, V_{INH}		2.0	V min	
Input Low Voltage, V_{INL}		0.4	V max	
Input Current I_{INL} or I_{INH}	0.005	± 0.1	μA typ μA max	$V_{IN} = V_{INL}$ or V_{INH}
DYNAMIC CHARACTERISTICS²				
t_{ON}	16	24	ns typ ns max	$R_L = 300\ \Omega$, $C_L = 35\text{ pF}$ $V_S = 2\text{ V}$, Test Circuit 4
t_{OFF}	8	16	ns typ ns max	$R_L = 300\ \Omega$, $C_L = 35\text{ pF}$ $V_S = 2\text{ V}$, Test Circuit 4
Break-Before-Make Time Delay, t_D	9	1	ns typ ns min	$R_L = 300\ \Omega$, $C_L = 35\text{ pF}$ $V_{S1} = V_{S2} = 2\text{ V}$, Test Circuit 5
Charge Injection	3		pC typ	$V_S = 1.5\text{ V}$, $R_S = 0\ \Omega$, $C_L = 1\text{ nF}$; Test Circuit 6
Off Isolation	-60 -80		dB typ dB typ	$R_L = 50\ \Omega$, $C_L = 5\text{ pF}$, $f = 10\text{ MHz}$; $R_L = 50\ \Omega$, $C_L = 5\text{ pF}$, $f = 1\text{ MHz}$; Test Circuit 7
Channel-to-Channel Crosstalk	-62 -82		dB typ dB typ	$R_L = 50\ \Omega$, $C_L = 5\text{ pF}$, $f = 10\text{ MHz}$; $R_L = 50\ \Omega$, $C_L = 5\text{ pF}$, $f = 1\text{ MHz}$; Test Circuit 8
Bandwidth -3 dB	200		MHz typ	$R_L = 50\ \Omega$, $C_L = 5\text{ pF}$; Test Circuit 9
C_S (OFF)	9		pF typ	
C_D (OFF)	37		pF typ	
C_D , C_S (ON)	54		pF typ	
POWER REQUIREMENTS				
I_{DD}	0.001	1.0	μA typ μA max	$V_{DD} = +3.3\text{ V}$ Digital Inputs = 0 V or 3 V

NOTES

¹Temperature ranges are as follows: B Version: -40°C to $+85^{\circ}\text{C}$.²Guaranteed by design, not subject to production test.

Specifications subject to change without notice.

ADG704

ABSOLUTE MAXIMUM RATINGS¹

(T_A = +25°C unless otherwise noted)

V _{DD} to GND -0.3 V to +6 V
Analog, Digital Inputs ² -0.3 V to V _{DD} +0.3 V or 30 mA, Whichever Occurs First
Continuous Current, S or D 30 mA
Peak Current, S or D 100 mA (Pulsed at 1 ms, 10% Duty Cycle Max)
Operating Temperature Range	
Industrial (B Version) -40°C to +85°C
Storage Temperature Range -65°C to +150°C
Junction Temperature +150°C
μSOIC Package, Power Dissipation 315 mW
θ _{JA} Thermal Impedance 206°C/W
Lead Temperature, Soldering	
Vapor Phase (60 sec) +215°C
Infrared (15 sec) +220°C
ESD 2 kV

NOTES

¹Stresses above those listed under Absolute Maximum Ratings may cause permanent damage to the device. This is a stress rating only; functional operation of the device at these or any other conditions above those listed in the operational sections of this specification is not implied. Exposure to absolute maximum rating conditions for extended periods may affect device reliability. Only one absolute maximum rating may be applied at any one time.

²Overvoltages at IN, S or D will be clamped by internal diodes. Current should be limited to the maximum ratings given.

ORDERING GUIDE

Model	Temperature Range	Brand ¹	Package Option ²
ADG704BRM	-40°C to +85°C	S9B	RM-10

NOTES

¹Brand = Due to small package size, these three characters represent the part number.

²RM = μSOIC.

PIN CONFIGURATION (10-Lead μSOIC)

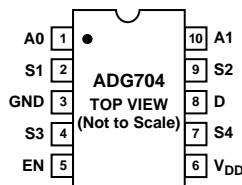

TERMINOLOGY

V _{DD}	Most positive power supply potential.
GND	Ground (0 V) reference.
S	Source terminal. May be an input or output.
D	Drain terminal. May be an input or output.
A0, A1	Logic control inputs.
EN	Logic control input.
R _{ON}	Ohmic resistance between D and S.
ΔR _{ON}	On resistance match between any two channels i.e., R _{ONmax} –R _{ONmin} .
R _{FLAT(ON)}	Flatness is defined as the difference between the maximum and minimum value of on resistance as measured over the specified analog signal range.
I _D (OFF)	Drain leakage current with the switch “OFF.”
I _S (OFF)	Source leakage current with the switch “OFF.”
I _D , I _S (ON)	Channel leakage current with the switch “ON.”
V _D (V _S)	Analog voltage on terminals D, S.
C _S (OFF)	“OFF” switch source capacitance.
C _D (OFF)	“OFF” switch drain capacitance.
C _D , C _S (ON)	“ON” switch capacitance.
t _{ON}	Delay between applying the digital control input and the output switching on. See Test Circuit 4.
t _{OFF}	Delay between applying the digital control input and the output switching off.
t _D	“OFF” time or “ON” time measured between the 90% points of both switches, when switching from one address state to another. See Test Circuit 5.
Crosstalk	A measure of unwanted signal that is coupled through from one channel to another as a result of parasitic capacitance.
Off Isolation	A measure of unwanted signal coupling through an “OFF” switch.
Charge Injection	A measure of the glitch impulse transferred from the digital input to the analog output during switching.
Bandwidth	The frequency at which the output is attenuated by –3 dBs.
On Response	The frequency response of the “ON” switch.
On Loss	The voltage drop across the “ON” switch, seen on the On Response vs. Frequency plot as how many dBs the signal is away from 0 dB at very low frequencies.

Table I. Truth Table

A1	A0	EN	ON Switch
X	X	0	NONE
0	0	1	1
0	1	1	2
1	0	1	3
1	1	1	4

CAUTION

ESD (electrostatic discharge) sensitive device. Electrostatic charges as high as 4000 V readily accumulate on the human body and test equipment and can discharge without detection. Although the ADG704 features proprietary ESD protection circuitry, permanent damage may occur on devices subjected to high energy electrostatic discharges. Therefore, proper ESD precautions are recommended to avoid performance degradation or loss of functionality.



Typical Performance Characteristics—ADG704

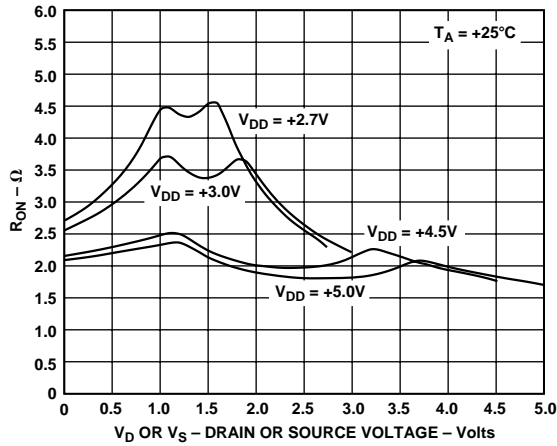

Figure 1. On Resistance as a Function of V_D (V_S) Single Supplies

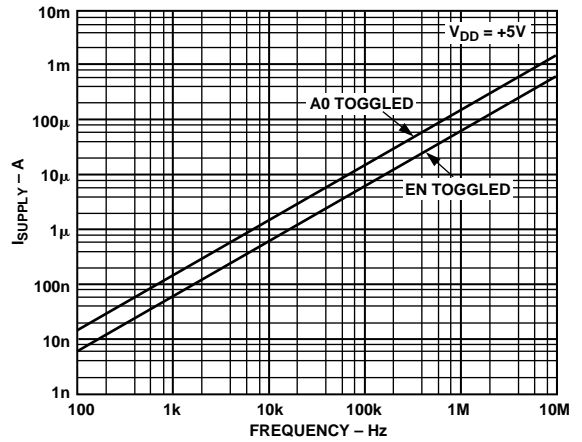

Figure 4. Supply Current vs. Input Switching Frequency

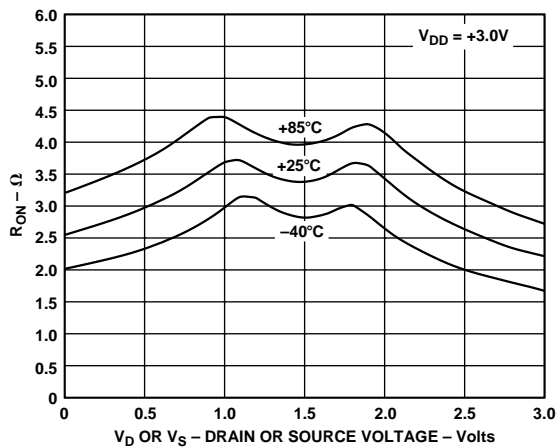

Figure 2. On Resistance as a Function of V_D (V_S) for Different Temperatures; $V_{DD} = 3\text{ V}$

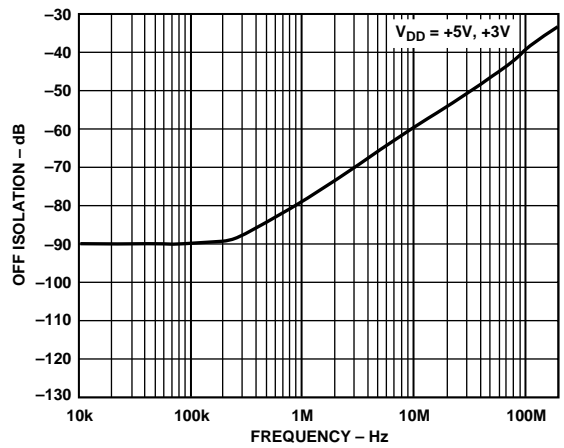

Figure 5. Off Isolation vs. Frequency

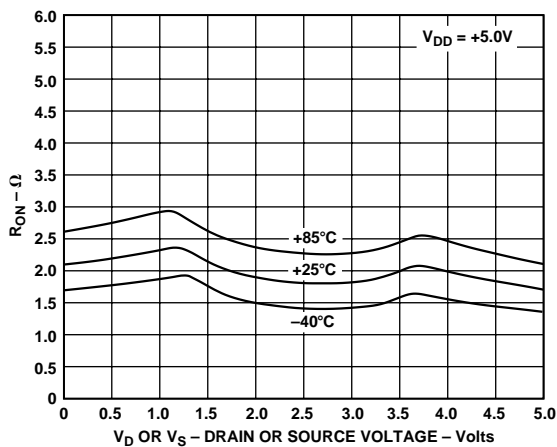

Figure 3. On Resistance as a Function of V_D (V_S) for Different Temperatures; $V_{DD} = 5\text{ V}$

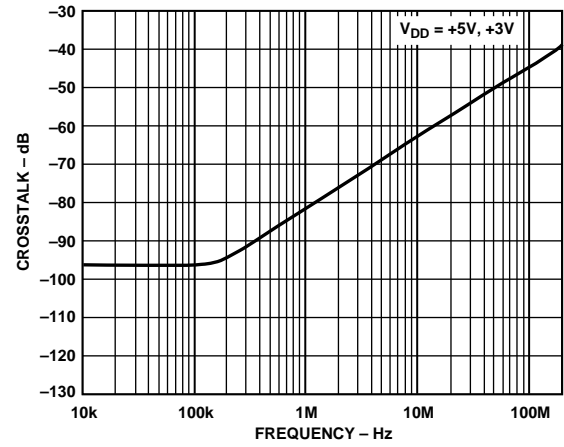

Figure 6. Crosstalk vs. Frequency

ADG704

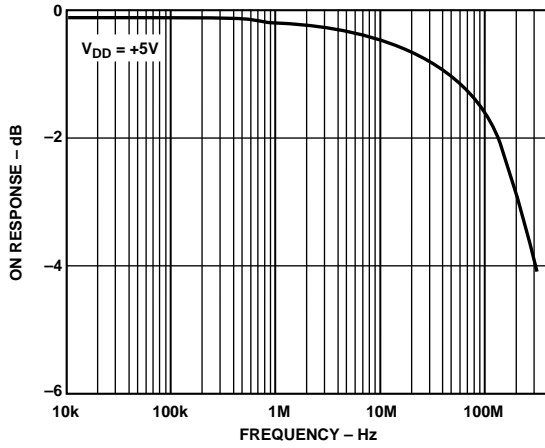

Figure 7. On Response vs. Frequency

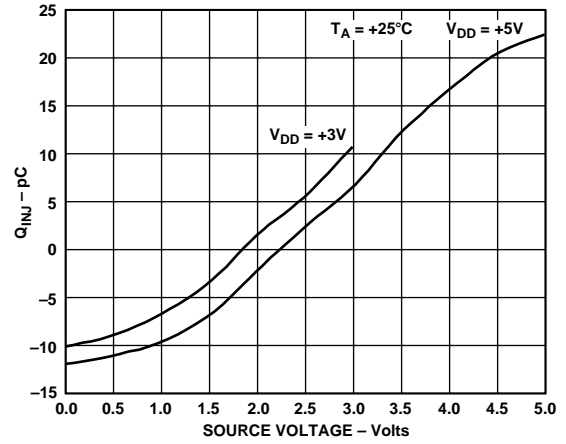

Figure 8. Charge Injection vs. Source Voltage

APPLICATIONS

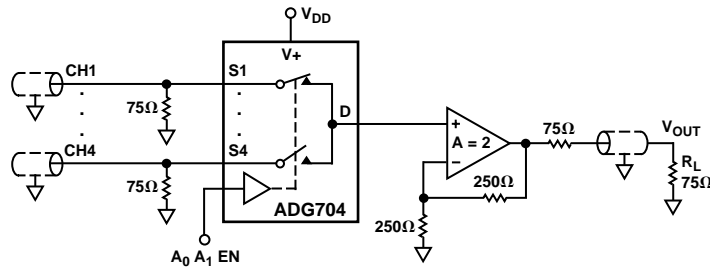
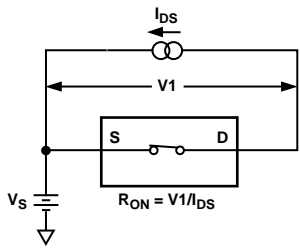
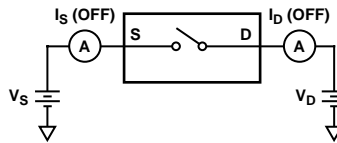

Figure 9. 4-Channel Video Multiplexing

Test Circuits



Test Circuit 1. On Resistance



Test Circuit 2. Off Leakage

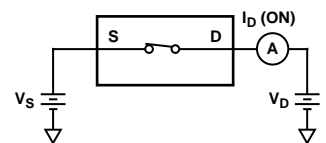

Test Circuit 3. On Leakage

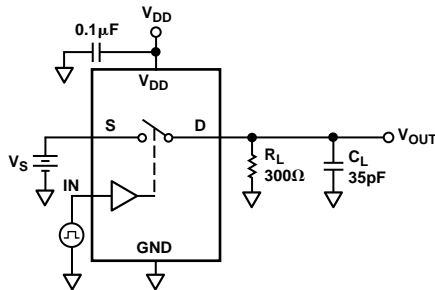

Test Circuit 4. Switching Times

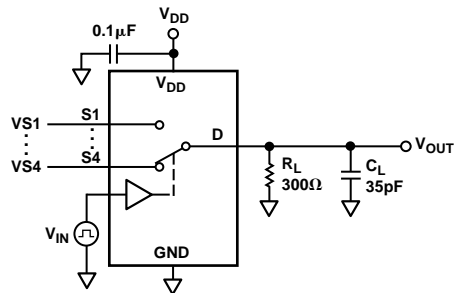

Test Circuit 5. Break-Before-Make Time Delay, t_D

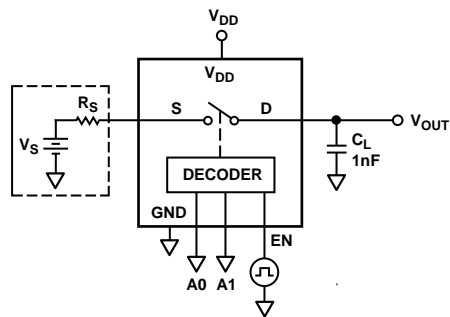

Test Circuit 6. Charge Injection

ADG704

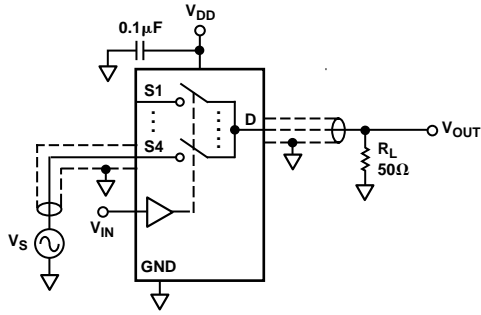

Test Circuit 7. Off Isolation

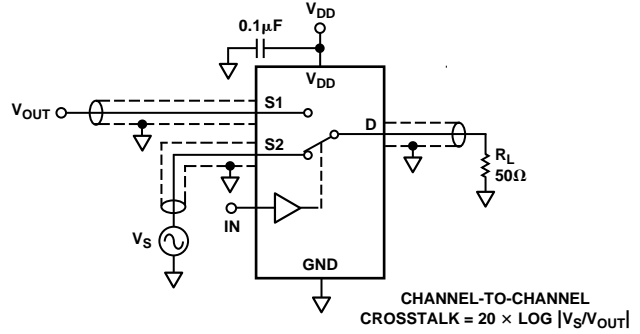

Test Circuit 8. Channel-to-Channel Crosstalk

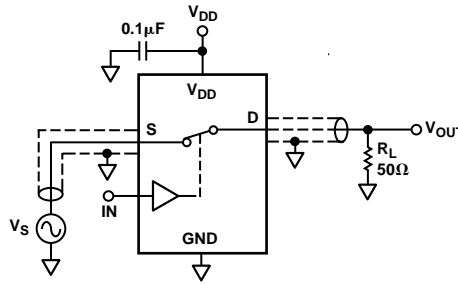

Test Circuit 9. Bandwidth

OUTLINE DIMENSIONS

Dimensions shown in inches and (mm).

10-Lead μ SOIC (RM-10)

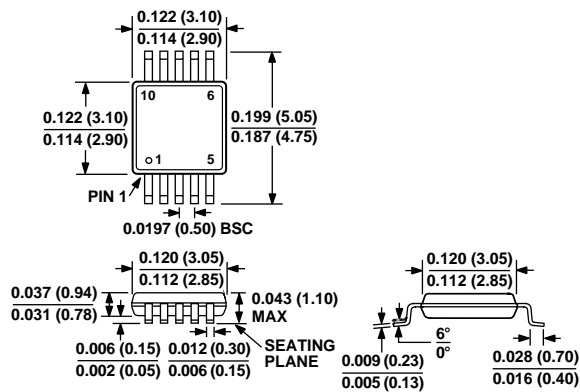

Данный компонент на территории Российской Федерации

Вы можете приобрести в компании MosChip.

Для оперативного оформления запроса Вам необходимо перейти по данной ссылке:

<http://moschip.ru/get-element>

Вы можете разместить у нас заказ для любого Вашего проекта, будь то серийное производство или разработка единичного прибора.

В нашем ассортименте представлены ведущие мировые производители активных и пассивных электронных компонентов.

Нашей специализацией является поставка электронной компонентной базы двойного назначения, продукции таких производителей как XILINX, Intel (ex.ALTERA), Vicor, Microchip, Texas Instruments, Analog Devices, Mini-Circuits, Amphenol, Glenair.

Сотрудничество с глобальными дистрибьюторами электронных компонентов, предоставляет возможность заказывать и получать с международных складов практически любой перечень компонентов в оптимальные для Вас сроки.

На всех этапах разработки и производства наши партнеры могут получить квалифицированную поддержку опытных инженеров.

Система менеджмента качества компании отвечает требованиям в соответствии с ГОСТ Р ИСО 9001, ГОСТ РВ 0015-002 и ЭС РД 009

Офис по работе с юридическими лицами:

105318, г.Москва, ул.Щербаковская д.3, офис 1107, 1118, ДЦ «Щербаковский»

Телефон: +7 495 668-12-70 (многоканальный)

Факс: +7 495 668-12-70 (доб.304)

E-mail: info@moschip.ru

Skype отдела продаж:

moschip.ru

moschip.ru_4

moschip.ru_6

moschip.ru_9