



Mixed-Signal Control Processor with ARM Cortex-M4 and 16-Bit ADCs

ADSP-CM402F/CM403F/CM407F/CM408F/CM409F

SYSTEM FEATURES

Up to 240 MHz ARM Cortex-M4 with floating-point unit
24-channel analog front end (AFE) with 16-bit ADCs
128K Byte to 384K Byte zero-wait-state L1 SRAM with
16K Byte L1 cache

Up to 2M Byte flash memory

Single 3.3 V power supply

Package Options:

176-lead (24 mm × 24 mm) LQFP package

120-lead (14 mm × 14 mm) LQFP package

212-ball (19 mm × 19 mm) BGA package

Static memory controller (SMC) with asynchronous memory
interface that supports 8-bit and 16-bit memories

Enhanced PWM units

Four 3rd/4th order SINC filter pairs for glueless connection of
sigma-delta modulators

Hardware-based harmonic analysis engine

10/100 Ethernet MAC with IEEE 1588v2 support

Full Speed USB on-the-go (OTG)

Two CAN (controller area network) 2.0B interfaces

Three UART ports

Two serial peripheral interface (SPI-compatible) ports

Three/four synchronous serial ports

Eight 32-bit GP timers, three capture timing units

Four encoder interfaces, 2 with frequency division

One TWI unit, fully compatible with I²C bus standard

Lightweight security

ANALOG FRONT END

Two 16-bit SAR ADCs with up to 24 multiplexed inputs,
supporting dual simultaneous conversion in 380 ns (16-bit,
no missing codes)

ADC controller (ADCC) and DAC controller (DACC)

Two 12-bit DACs

Two 2.5 V precision voltage reference outputs

(For details, see [ADC/DAC Specifications on Page 68](#))

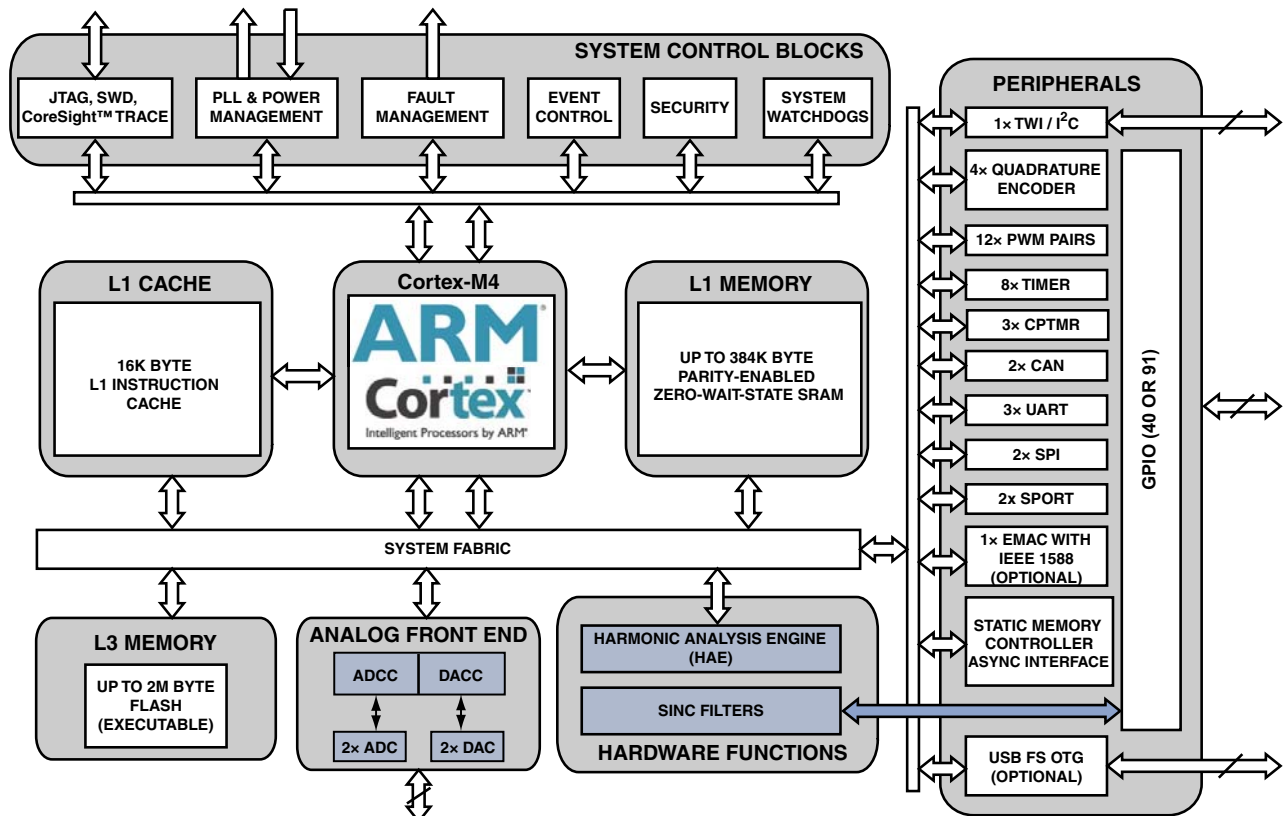

Figure 1. Block Diagram

Rev. A

[Document Feedback](#)

Information furnished by Analog Devices is believed to be accurate and reliable. However, no responsibility is assumed by Analog Devices for its use, nor for any infringements of patents or other rights of third parties that may result from its use. Specifications subject to change without notice. No license is granted by implication or otherwise under any patent or patent rights of Analog Devices. Trademarks and registered trademarks are the property of their respective owners.

One Technology Way, P.O. Box 9106, Norwood, MA 02062-9106 U.S.A.
Tel: 781.329.4700 ©2015 Analog Devices, Inc. All rights reserved.
[Technical Support](#) www.analog.com

ADSP-CM402F/CM403F/CM407F/CM408F/CM409F

TABLE OF CONTENTS

General Description	3	ADSP-CM409F 212-Ball BGA Signal Descriptions	40
Analog Front End	4	ADSP-CM409F GPIO Multiplexing for 212-Ball BGA	48
ARM Cortex-M4 Core	7	ADSP-CM40xF Designer Quick Reference	51
EmbeddedICE	7	Specifications	64
Processor Infrastructure	8	Operating Conditions	64
Memory Architecture	8	Electrical Characteristics	66
System Acceleration	10	ADC/DAC Specifications	68
Security Features	10	Flash Specifications	74
Processor Reliability Features	11	Absolute Maximum Ratings	75
Additional Processor Peripherals	11	ESD Sensitivity	75
Clock and Power Management	14	Package Information	75
System Debug Unit (SDU)	16	Timing Specifications	76
Development Tools	17	Processor Test Conditions	107
Additional Information	17	Output Drive Currents	107
Related Signal Chains	17	Environmental Conditions	108
Security Features Disclaimer	17	ADSP-CM402F/ADSP-CM403F 120-Lead LQFP	
ADSP-CM40xF Detailed Signal Descriptions	18	Lead Assignments	110
ADSP-CM402F/ADSP-CM403F 120-Lead LQFP		ADSP-CM407F/ADSP-CM408F 176-Lead LQFP	
Signal Descriptions	22	Lead Assignments	113
ADSP-CM402F/ADSP-CM403F GPIO Multiplexing		ADSP-CM409F 212-Ball BGA Ball Assignments	117
for 120-Lead LQFP	27	Outline Dimensions	121
ADSP-CM407F/ADSP-CM408F 176-Lead LQFP		Ordering Guide	124
Signal Descriptions	29		
ADSP-CM407F/ADSP-CM408F GPIO Multiplexing			
for 176-Lead LQFP	37		

REVISION HISTORY

11/15—Rev. 0 to Rev. A

Change to equation in Serial Ports	83
Change to equation in Serial Peripheral Interface (SPI) Port—Master Timing	89
Changes to Ordering Guide	124

ADSP-CM402F/CM403F/CM407F/CM408F/CM409F

GENERAL DESCRIPTION

The ADSP-CM40xF family of mixed-signal control processors is based on the ARM® Cortex-M4™ processor core with floating-point unit operating at frequencies up to 240 MHz and integrating up to 384 kB of SRAM memory, 2 MB of flash memory, accelerators and peripherals optimized for motor control and photo-voltaic (PV) inverter control and an analog module consisting of two 16-bit SAR ADCs and two 12-bit DACs. The ADSP-CM40xF family operates from a single voltage supply (VDD_EXT/VDD_ANA), generating its own internal voltage supplies using internal voltage regulators and an external pass transistor.

This family of mixed-signal control processors offers low static power consumption and is produced with a low power and low voltage design methodology, delivering world class processor and ADC performance with lower power consumption.

By integrating a rich set of industry-leading system peripherals and memory (shown in Table 1), the ADSP-CM40xF mixed-signal control processors are the platform of choice for next-generation applications that require RISC programmability, advanced communications and leading-edge signal processing in one integrated package. These applications span a wide array of markets including power/motor control, embedded industrial, instrumentation, medical and consumer.

Each ADSP-CM40xF family member contains the following modules.

- 8 GP timers with PWM output
- 3-phase PWM units with up to 4 output pairs per unit
- 2 CAN modules
- 1 two-wire interface (TWI) module
- 3 UARTs
- 1 ADC controller (ADCC) to control on-chip ADCs
- 1 DAC controller (DACC) to control on-chip DACs
- 4 Sinus Cardinalis (SINC) filter pairs
- 1 harmonic analysis engine (HAE)
- 2 SPI (1 connected to internal SPI flash memory)
- 3 half-SPORTs
- 1 watchdog timer unit
- 3 capture timer units
- 1 cyclic redundancy check (CRC)

Table 1 provides the additional product features shown by model.

Table 1. ADSP-CM4 0xF Family Product Features

Generic	ADSP-CM402F		ADSP-CM403F		ADSP-CM407F			ADSP-CM408F		ADSP-CM409F	
Package	120-Lead LQFP				176-Lead LQFP					212-Ball BGA	
GPIOs	40							91			
SMC	16-Bit Asynchronous/5 Address				16-Bit Asynchronous/24 Address						
ADC ENOB (No Averaging)	11+		13+		11+			13+			
ADC Inputs	24				16					24	
DAC Outputs	2				N/A					2	
SPORTs	3 Half-SPORTs				4 Half-SPORTs						
Ethernet	N/A				1	N/A	N/A	1	N/A	1	
USB	N/A				1	1	N/A	1	1	1	
External SPI	1							2			
HAE					1						
CAN					2						
UART					3						
Feature Set Code	E	F	C	E	F	A	B	D	A	B	A
L1 SRAM (kB)	128	128	384	128	128	384	384	128	384	384	384
Flash (kB)	512	256	2048	512	256	2048	2048	1024	2048	2048	2048
Core Clock (MHz)	150	100	240	150	100	240	240	150	240	240	240
Model	ADSP-CM402CSWZ-EF	ADSP-CM402CSWZ-FF	ADSP-CM403CSWZ-CF	ADSP-CM403CSWZ-EF	ADSP-CM403CSWZ-FF	ADSP-CM407CSWZ-AF	ADSP-CM407CSWZ-BF	ADSP-CM407CSWZ-DF	ADSP-CM408CSWZ-AF	ADSP-CM408CSWZ-BF	ADSP-CM409CBCZ-AF

ADSP-CM402F/CM403F/CM407F/CM408F/CM409F



NOTE: DAC0 AND DAC1 CAN BE MUX SELECTED THROUGH AN INTERNAL PATH WITHIN THE CHIP. SEE THE HARDWARE REFERENCE MANUAL FOR PROGRAMMING DETAIL.

Figure 3. ADSP-CM407F/ADSP-CM408F Analog Subsystem Block Diagram

Considerations for Best Converter Performance

As with any high performance analog/digital circuit, to achieve best performance, good circuit design and board layout practices should be followed. The power supply and its noise bypass (decoupling), ground return paths and pin connections, and analog/digital routing channel paths and signal shielding, are all of first-order consideration. For application hints on design best practice, see [Figure 4](#) and the *ADSP-CM40x Mixed-Signal Control Processor with ARM Cortex-M4 Hardware Reference*. For more information about the VREG circuit, see [Figure 9](#).

ADC Module

The ADC module contains two 16-bit, high speed, low power successive approximation register (SAR) ADCs, allowing for dual simultaneous sampling with each ADC preceded by a 12-channel multiplexer. See [ADC Specifications on Page 68](#) for detailed performance specifications. Input multiplexers enable conversion of up to a combined 26 analog input sources to the ADCs (12 analog inputs plus 1 DAC loopback input per ADC).

The voltage input range requirement for those analog inputs is from 0 V to 2.5 V. All analog inputs are of single-ended design. As with all single-ended inputs, signals from high impedance sources are the most difficult to measure, and depending on the

electrical environment, may require an external buffer circuit for signal conditioning (see [Figure 5](#)). An on-chip pre-buffer between the multiplexer and ADC reduces the need for additional signal conditioning external to the processor. Additionally, each ADC has an on-chip 2.5 V reference that can be overdriven when an external voltage reference is preferred.

DAC Module

The DAC is a 12-bit, low power, string DAC design. The output of the DAC is buffered, and can drive an R/C load to either ground or VDD_ANA. See [DAC Specifications on Page 70](#) for detailed performance specifications. It should be noted that on some models of the processor, the DAC outputs are not pinned out. However, these outputs are always available as one of the multiplexed inputs to the ADCs. This feature may be useful for functional self-check of the converters.

Note: On the ADSP-CM402F/CM403F/CM409F processors, the DAC output is available to the ADC as channel 12; whereas on the ADSP-CM407F/CM408F processors, the DAC output is available to the ADC as Channel 8.

ADSP-CM402F/CM403F/CM407F/CM408F/CM409F



Figure 4. Typical Power Supply Configuration



Figure 5. Equivalent Single-Ended Input (Simplified)

ADSP-CM402F/CM403F/CM407F/CM408F/CM409F

ARM CORTEX-M4 CORE

The ARM Cortex-M4, core shown in Figure 6, is a 32-bit reduced instruction set computer (RISC). It uses 32-bit buses for instruction and data. The length of the data can be 8 bits, 16 bits, or 32 bits. The length of the instruction word is 16 or 32 bits. The controller has the following features.

Cortex-M4 Architecture

- Thumb-2 ISA technology
- DSP and SIMD extensions
- Single cycle MAC (Up to $32 \times 32 + 64 \rightarrow 64$)
- Hardware divide instructions
- Single-precision FPU
- NVIC interrupt controller (129 interrupts and 16 priorities)
- Memory protection unit (MPU)
- Full CoreSight™ debug, trace, breakpoints, watchpoints, and cross-triggers

Microarchitecture

- 3-stage pipeline with branch speculation
- Low-latency interrupt processing with tail chaining

Configurable For Ultra Low Power

- Deep sleep mode, dynamic power management
- Programmable clock generator unit

EmbeddedICE

EmbeddedICE™ provides integrated on-chip support for the core. The EmbeddedICE module contains the breakpoint and watchpoint registers that allow code to be halted for debugging purposes. These registers are controlled through the JTAG test port.

When a breakpoint or watchpoint is encountered, the processor halts and enters debug state. Once in a debug state, the processor registers can be inspected as well as the Flash/EE, SRAM, and memory-mapped registers.



Figure 6. Cortex-M4 Block Diagram

ADSP-CM402F/CM403F/CM407F/CM408F/CM409F

PROCESSOR INFRASTRUCTURE

The following sections provide information on the primary infrastructure components of the ADSP-CM40xF processors.

DMA Controllers (DDEs)

The processor contains 17 independent and concurrently operating peripheral DMA channels plus two MDMA streams. DDE Channel 0 to Channel 16 are for peripherals and Channel 17 to Channel 20 are for MDMA.

System Event Controller (SEC)

The SEC manages the enabling and routing of system fault sources through its integrated fault management unit.

Trigger Routing Unit (TRU)

The TRU provides system-level sequence control without core intervention. The TRU maps trigger masters (generators of triggers) to trigger slaves (receivers of triggers). Slave endpoints can be configured to respond to triggers in various ways. Common applications enabled by the TRU include:

- Initiating the ADC sampling periodically in each PWM period or based on external events
- Automatically triggering the start of a DMA sequence after a sequence from another DMA channel completes
- Software triggering
- Synchronization of concurrent activities

Pin Interrupts (PINT)

Every port pin on the processor can request interrupts in either an edge-sensitive or a level-sensitive manner with programmable polarity. Interrupt functionality is decoupled from GPIO operation. Six system-level interrupt channels (PINT0 to PINT5) are reserved for this purpose. Each of these interrupt channels can manage up to 32 interrupt pins. The assignment from pin to interrupt is not performed on a pin-by-pin basis. Rather, groups of eight pins (half ports) can be flexibly assigned to interrupt channels.

Every pin interrupt channel features a special set of 32-bit memory-mapped registers that enable half-port assignment and interrupt management. This includes masking, identification, and clearing of requests. These registers also enable access to the respective pin states and use of the interrupt latches, regardless of whether the interrupt is masked or not. Most control registers feature multiple MMR address entries to write-one-to-set or write-one-to-clear them individually.

General-Purpose I/O (GPIO)

Each general-purpose port pin can be individually controlled by manipulation of the port control, status, and interrupt registers:

- GPIO direction control register—Specifies the direction of each individual GPIO pin as input or output.
- GPIO control and status registers —A write one to modify mechanism allows any combination of individual GPIO pins to be modified in a single instruction, without affecting the level of any other GPIO pins.

- GPIO interrupt mask registers—Allow each individual GPIO pin to function as an interrupt to the processor. GPIO pins defined as inputs can be configured to generate hardware interrupts, while output pins can be triggered by software interrupts.
- GPIO interrupt sensitivity registers—Specify whether individual pins are level- or edge-sensitive and specify—if edge-sensitive—whether just the rising edge or both the rising and falling edges of the signal are significant.

Pin Multiplexing

The processor supports a flexible multiplexing scheme that multiplexes the GPIO pins with various peripherals. A maximum of five peripherals plus GPIO functionality is shared by each GPIO pin. All GPIO pins have a bypass path feature—that is, when the output enable and the input enable of a GPIO pin are both active, the data signal before the pad driver is looped back to the receive path for the same GPIO pin.

For more information, see:

- [ADSP-CM402F/ADSP-CM403F GPIO Multiplexing for 120-Lead LQFP on Page 27.](#)
- [ADSP-CM407F/ADSP-CM408F GPIO Multiplexing for 176-Lead LQFP on Page 37.](#)
- [ADSP-CM409F GPIO Multiplexing for 212-Ball BGA on Page 48.](#)

MEMORY ARCHITECTURE

The internal and external memory of the ADSP-CM40xF processor is shown in [Figure 7](#) and described in the following sections.

ARM Cortex-M4 Memory Subsystem

The memory map of the ADSP-CM40xF family is based on the Cortex-M4 model from ARM. By retaining the standardized memory mapping, it becomes easier to port applications across M4 platforms. Only the physical implementation of memories inside the model differs from other vendors.

ADSP-CM40xF application development is typically based on memory blocks across CODE/SRAM and external memory regions. Sufficient internal memory is available via internal SRAM and internal flash. Additional external memory devices may be interfaced via the SMC asynchronous memory port, as well as through the SPI0 serial memory interface.

Code Region

Accesses in this region (0x0000_0000 to 0x1FFF_FFFF) are performed by the core on its ICODE and DCODE interfaces, and they target the memory and cache resources within the Cortex-M4F platform integration component.

- **Boot ROM.** A 32K byte boot ROM executed at system reset. This space supports read-only access by the M4F core only. Note that ROM memory contents cannot be modified by the user.

ADSP-CM402F/CM403F/CM407F/CM408F/CM409F

- **Internal SRAM Code Region.** This memory space contains the application instructions and literal (constant) data which must be executed real time. It supports read/write access by the M4F core and read/write DMA access by system devices. Internal SRAM can be partitioned between CODE and DATA (SRAM region in M4 space) in 64K byte blocks. Access to this region occurs at core clock speed, with no wait states.
- **Integrated Flash.** This contains the 2M byte flash memory space interfaced via the SPI2 port of the processor. This memory space contains the application instructions and literal (constant) data. Reads from flash memory are directly cached via internal code cache. Direct memory-mapped reads are permitted through SPI memory-mapped protocol. Internal flash memory ships from the factory in an erased state except for Sector 0 and Sector 1 of the main flash array. Sector 0 and Sector 1 of the main flash array ships from the factory in an unknown state. An erase operation should be performed prior to programming this sector.
- **Internal Code Cache.** A zero-wait-state code cache SRAM memory is available internally (not visible in the memory map) to cache instruction access from internal flash as well as any externally connected serial flash and asynchronous memory.
- **MEM-X/MEM-Y.** These are virtual memory blocks which are used as cacheable memory for the code cache. No physical memory device resides inside these blocks. The application code must be compiled against these memory blocks to utilize the cache.

SRAM Region

Accesses in this region (0x2000_0000 to 0x3FFF_FFFF) are performed by the ARM Cortex-M4F core on its SYS interface. The SRAM region of the core can otherwise act as a data region for an application.

- **Internal SRAM Data Region.** This space can contain read/write data. Internal SRAM can be partitioned between CODE and DATA (SRAM region in M4 space) in 64K byte blocks. Access to this region occurs at core clock speed, with no wait states. It supports read/write access by the M4F core and read/write DMA access by system devices. It supports exclusive memory accesses via the global exclusive access monitor within the Cortex-M4F platform. Bit-banding support is also available.

System Memory Spaces

- **External SPI Flash.** Up to 16M byte of external serial quad flash memory optionally connected to the SPI0 port of the processor. Reads from flash memory are directly cached via internal code cache. Direct memory-mapped reads are permitted via SPI memory-mapped protocol.
- **System MMRs.** Various system MMRs reside in this region. Bit-banding support is available for MMRs.

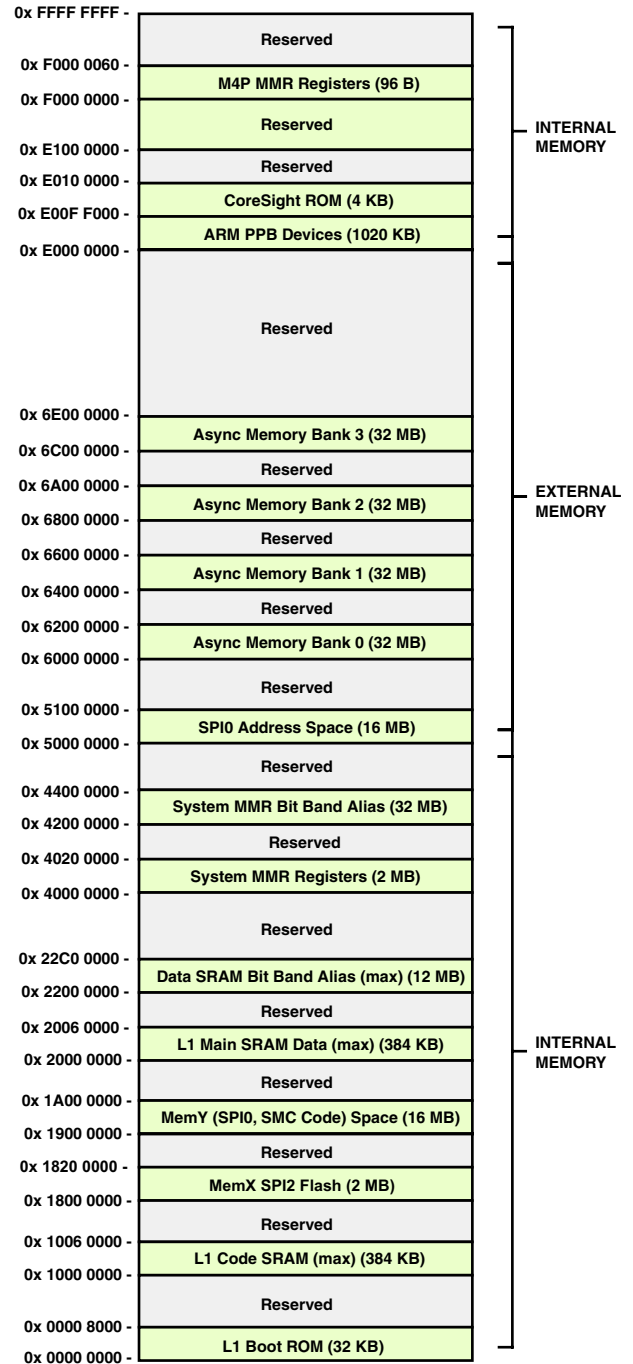

Figure 7. ADSP-CM40xF Memory Map

External Asynchronous Parallel Flash/RAM

- **L2 Asynchronous Memory.** Up to 32M byte × 4 banks of external memory can be optionally connected to the asynchronous memory port (SMC). Code execution from these memory blocks can be optionally cached via internal code cache. Direct R/W data access is also possible.

ADSP-CM402F/CM403F/CM407F/CM408F/CM409F

System Region

Accesses in this region (0xE000_0000 to 0xF7FF_FFFF) are performed by the ARM Cortex-M4F core on its SYS interface, and are handled within the Cortex-M4F platform. The MPU may be programmed to limit access to this space to privileged mode only.

- **CoreSight ROM.** The ROM table entries point to the debug components of the processor.
- **ARM PPB Peripherals.** This space is defined by ARM and occupies the bottom 256K byte of the SYS region (0xE000_0000 to 0xE004_0000). The space supports read/write access by the M4F core to the ARM core's internal peripherals (MPU, ITM, DWT, FPB, SCS, TPIU, ETM) and the CoreSight ROM. It is not accessible by system DMA.
- **Platform Control Registers.** This space has registers within the Cortex-M4F platform integration component that control the ARM core, its memory, and the code cache. It is accessible by the M4F core via its SYS port (but is not accessible by system DMA).

Static Memory Controller (SMC)

The SMC can be programmed to control up to four banks of external memories or memory-mapped devices, with very flexible timing parameters. On ADSP-CM407F/CM408F/CM409F processors, each bank can occupy a 32M byte segment regardless of the size of the device used.

Bootting (BOOT)

The processor has several mechanisms for automatically loading internal and external memory after a reset. The boot mode is defined by the SYS_BMODE input pins dedicated for this purpose. There are two categories of boot modes. In master boot modes, the processor actively loads data from a serial memory. In slave boot modes, the processor receives data from external host devices.

The boot modes are shown in [Table 2](#). These modes are implemented by the SYS_BMODE bits of the RCU_CTL register and are sampled during power-on resets and software-initiated resets.

Table 2. Boot Modes

SYS_BMODE[1:0] Setting	Description
00	No Boot/Idle. The processor does not boot. Rather the boot kernel executes an IDLE instruction.
01	Flash Boot. Boot from integrated Flash memory through the SPI2.
10	SPI Slave Boot. Boot through the SPI0 peripheral configured as a slave.
11	UART Boot. Boot through the UART0 peripheral configured as a slave.

SYSTEM ACCELERATION

The following sections describe the system acceleration blocks of the ADSP-CM40xF processors.

Harmonic Analysis Engine (HAE)

The harmonic analysis engine (HAE) block receives 8 kHz input samples from two source signals whose frequencies are between 45 Hz and 65 Hz. The HAE will then process the input samples and produce output results. The output results consist of power quality measurements of the fundamental and up to 12 selectable harmonics.

Sinus Cardinalis Filter (SINC)

The SINC module processes four bit streams using a pair of configurable SINC filters for each bitstream. The purpose of the primary SINC filter of each pair is to produce the filtered and decimated output for the pair. The output may be decimated to any integer rate between 8 and 256 times lower than the input rate. Greater decimation allows greater removal of noise and therefore greater ENOB.

Optional additional filtering outside the SINC module may be used to further increase ENOB. The primary SINC filter output is accessible through transfer to processor memory, or to another peripheral, via DMA.

Each of the four channels is also provided with a low-latency secondary filter with programmable positive and negative over-range detection comparators. These limit detection events can be used to interrupt the core, generate a trigger, or signal a system fault.

SECURITY FEATURES

The processor provides lightweight security functionality which protects sensitive data and IP located in the internal flash memory. It includes password-protected slave boot modes (SPI and UART), as well as password-protected JTAG/SWD debug interfaces. One of the safeguards of the security feature is the ability to perform bulk erase of the entire flash memory. Another security measure provides the ability to control which boot modes are allowed so as to protect the flash contents from untrusted or non-secure boot modes. Programs can enable or disable security features depending upon the secure header configured in internal flash memory.



CAUTION

This product includes security features that can be used to protect embedded nonvolatile memory contents and prevent execution of unauthorized code. When security is enabled on this device (either by the ordering party or the subsequent receiving parties), the ability of Analog Devices to conduct failure analysis on returned devices is limited. Contact Analog Devices for details on the failure analysis limitations for this device.

ADSP-CM402F/CM403F/CM407F/CM408F/CM409F

PROCESSOR RELIABILITY FEATURES

The processor provides the following features which can enhance or help achieve certain levels of system safety and reliability. While the level of safety is mainly dominated by system considerations, the following features are provided to enhance robustness.

Multi-Parity-Bit-Protected L1 Memories

In the processor's SRAM and cache L1 memory space, each word is protected by multiple parity bits to detect the single event upsets that occur in all RAMs.

Cortex MPU

The MPU divides the memory map into a number of regions, and allows the system programmer to define the location, size, access permissions, and memory attributes of each region. It supports independent attribute settings for each region, overlapping regions, and export of memory attributes to the system.

For more information, refer to the ARM Infocenter web page.

System Protection Unit (SPU)

All system resources and L2 memory banks can be controlled by either the processor core, memory-to-memory DMA, or the debug unit. A system protection unit (SPU) enables write accesses to specific resources that are locked to a given master. System protection is enabled in greater granularity for some modules through a global lock concept.

Watchpoint Protection

The primary purpose of watchpoints and hardware breakpoints is to serve emulator needs. When enabled, they signal an emulator event whenever user-defined system resources are accessed or a core executes from user-defined addresses. Watchdog events can be configured such that they signal the events to the core or to the SEC.

Software Watchdog

The on-chip watchdog timer can provide software-based supervision of the ADSP-CM40xF core.

Signal Watchdogs

The eight general-purpose timers feature two modes to monitor off-chip signals. The watchdog period mode monitors whether external signals toggle with a period within an expected range. The watchdog width mode monitors whether the pulse widths of external signals are in an expected range. Both modes help to detect incorrect undesired toggling (or lack thereof) of system-level signals.

Oscillator Watchdog

The oscillator watchdog monitors the external clock oscillator, and can detect the absence of clock as well as incorrect harmonic oscillation. The oscillator watchdog detection signal is routed to the fault management portion of the system event controller.

Low-Latency Sinc Filter Over-range Detection

The SINC filter units provide a low-latency secondary filter with programmable positive and negative limit detectors for each input channel. These may be used to monitor an isolation ADC bitstream for overrange or underrange conditions with a filter group delay as low as 0.7 μ s on a 10 MHz bitstream. The secondary SINC filter events can be used to interrupt the core, to trigger other events directly in hardware using the trigger routing unit (TRU), or to signal the fault management unit of a system fault.

Up/Down Count Mismatch Detection

The GP counter can monitor external signal pairs, such as request/grant strobes. If the edge count mismatch exceeds the expected range, the up/down counter can flag this to the processor or to the system event controller (SEC).

Fault Management

The fault management unit is part of the system event controller (SEC). Most system events can be defined as faults. If defined as such, the SEC forwards the event to its fault management unit which may automatically reset the entire device for reboot, or simply toggle the `SYS_FAULT` output pin to signal off-chip hardware. Optionally, the fault management unit can delay the action taken via a keyed sequence, to provide a final chance for the core to resolve the crisis and to prevent the fault action from being taken.

ADDITIONAL PROCESSOR PERIPHERALS

The processor contains a rich set of peripherals connected to the core via several concurrent high-bandwidth buses, providing flexibility in system configuration as well as excellent overall system performance (see [Figure 1](#), Block Diagram).

The processor contains high speed serial and parallel ports, an interrupt controller for flexible management of interrupts from the on-chip peripherals or external sources, and power management control functions to tailor the performance and power characteristics of the processor and system to many application scenarios.

The following sections describe additional peripherals that were not described in the previous sections.

Timers

The processor includes several timers which are described in the following sections.

General-Purpose Timers (TIMER)

The general-purpose (GP) timer unit provides eight general-purpose programmable timers. Each timer has an external pin that can be configured either as a pulse width modulator (PWM) or timer output, as an input to clock the timer, or as a mechanism for measuring pulse widths and periods of external events. These timers can be synchronized to an external clock input on the `TM0_ACLKx` pins, an external signal on the `TM0_CLK` input pin, or to the internal `SCLK`.

ADSP-CM402F/CM403F/CM407F/CM408F/CM409F

The timer unit can be used in conjunction with the UARTs and the CAN controller to measure the width of the pulses in the data stream to provide a software auto-baud detect function for the respective serial channels.

The timer can generate interrupts to the processor core, providing periodic events for synchronization to either the system clock or to external signals. Timer events can also trigger other peripherals via the TRU (for instance, to signal a fault).

Watchdog Timer (WDT)

The core includes a 32-bit timer, which may be used to implement a software watchdog function. A software watchdog can improve system availability by forcing the processor to a known state, via generation of a general-purpose interrupt, if the timer expires before being reset by software. The programmer initializes the count value of the timer, enables the appropriate interrupt, then enables the timer. Thereafter, the software must reload the counter before it counts to zero from the programmed value. This protects the system from remaining in an unknown state where software, which would normally reset the timer, has stopped running due to an external noise condition or software error. Optionally, the fault management unit (FMU) can directly initiate the processor reset upon the watchdog expiry event.

Capture Timer (CPTMR)

The processor includes three instances of capture timers (CPTMR) to capture total on time. Each capture timer captures total on time of the input signal between two leading edges of the input trigger signal. Capture timer inputs to all the timers come from external pins and the input trigger signal comes from trigger routing unit (TRU).

The core of the timer is a 32-bit counter which is reset at leading edge of the trigger and counts when the input signal level is active. The total on time of the input signal is captured from the counter at the leading edge of the trigger pulse. Capture timer can generate data interrupts to the processor core at leading edges of trigger pulses and status interrupts to indicate counter overflow condition.

3-Phase Pulse Width Modulator Unit (PWM)

The pulse width modulator (PWM) unit provides duty cycle and phase control capabilities to a resolution of one system clock cycle (SCLK). The heightened precision PWM (HPPWM) module provides increased performance to the PWM unit by increasing its resolution by several bits, resulting in enhanced precision levels. Additional features include:

- 16-bit center-based PWM generation unit
- Programmable PWM pulse width
- Single/double update modes
- Programmable dead time and switching frequency
- Twos-complement implementation which permits smooth transition to full on and full off states
- Dedicated asynchronous PWM trip signal

The eight PWM output signals (per PWM unit) consist of four high-side drive signals and four low-side drive signals. The polarity of a generated PWM signal can be set with software, so that either active high or active low PWM patterns can be produced.

Each PWM block integrates a flexible and programmable 3-phase PWM waveform generator that can be programmed to generate the required switching patterns to drive a 3-phase voltage source inverter for ac induction motor (ACIM) or permanent magnet synchronous motor (PMSM) control. In addition, the PWM block contains special functions that considerably simplify the generation of the required PWM switching patterns for control of the electronically commutated motor (ECM) or permanent magnet synchronous motor (PMSM) control. Software can enable a special mode for switched reluctance motors (SRM).

Each PWM unit features a dedicated asynchronous trip pin which (when brought low) instantaneously places all PWM outputs in the off state.

Serial Ports (SPORTs)

The synchronous serial ports provide an inexpensive interface to a wide variety of digital and mixed-signal peripheral devices such as Analog Devices, Inc., audio codecs, ADCs, and DACs. The serial ports are made up of two data lines per direction, a clock, and frame sync. The data lines can be programmed to either transmit or receive and each data line has a dedicated DMA channel.

Serial port data can be automatically transferred to and from on-chip memory/external memory via dedicated DMA channels. For full-duplex operation, two half SPORTs can work in conjunction with clock and frame sync signals shared internally through the SPMUX block. In some operation modes, SPORT supports gated clock.

Serial ports operate in six modes:

- Standard DSP serial mode
- Multichannel (TDM) mode
- I²S mode
- Packed I²S mode
- Left-justified mode
- Right-justified mode

General-Purpose Counters

The 32-bit counter can operate in general-purpose up/down count modes and can sense 2-bit quadrature or binary codes as typically emitted by industrial drives or manual thumbwheels. Count direction is either controlled by a level-sensitive input pin or by two edge detectors.

A third counter input can provide flexible zero marker support and can alternatively be used to input the push-button signal of thumb wheels. All three pins have a programmable debouncing circuit.

ADSP-CM402F/CM403F/CM407F/CM408F/CM409F

The GP counter can also support a programmable M/N frequency scaling of the CNT_CUD and CNT_CDG pins onto output pins in quadrature encoding mode.

Internal signals forwarded to each general-purpose timer enable these timers to measure the intervals between count events. Boundary registers enable auto-zero operation or simple system warning by interrupts when programmable count values are exceeded.

Serial Peripheral Interface Ports (SPI)

The processor contains the SPI-compatible port that allows the processor to communicate with multiple SPI-compatible devices.

In its simplest mode, the SPI interface uses three pins for transferring data: two data pins master output-slave input and master input-slave output (SPI_MOSI and SPI_MISO) and a clock pin, SPI_CLK. A SPI chip select input pin ($\overline{\text{SPI_SS}}$) lets other SPI devices select the processor, and three SPI chip select output pins (SPI_SELn) let the processor select other SPI devices. The SPI select pins are reconfigured general-purpose I/O pins. Using these pins, the SPI provides a full-duplex, synchronous serial interface, which supports both master and slave modes and multimaster environments.

In a multimaster or multislave SPI system, the MOSI and MISO data output pins can be configured to behave as open drain outputs (using the ODM bit) to prevent contention and possible damage to pin drivers. An external pull-up resistor is required on both the MOSI and MISO pins when this option is selected.

When ODM is set and the SPI is configured as a master, the MOSI pin is three-stated when the data driven out on MOSI is a logic high. The MOSI pin is not three-stated when the driven data is a logic low. Similarly, when ODM is set and the SPI is configured as a slave, the MISO pin is three-stated if the data driven out on MISO is a logic high.

The SPI port's baud rate and clock phase/polarities are programmable, and it has integrated DMA channels for both transmit and receive data streams.

Universal Asynchronous Receiver/Transmitter Ports (UART)

The processor provides full-duplex universal asynchronous receiver/transmitter (UART) ports, which are fully compatible with PC-standard UARTs. Each UART port provides a simplified UART interface to other peripherals or hosts, supporting full-duplex, DMA-supported, asynchronous transfers of serial data. A UART port includes support for five to eight data bits, and none, even, or odd parity. Optionally, an additional address bit can be transferred to interrupt only addressed nodes in multi-drop bus (MDB) systems. A frame is terminated by one, one and a half, two or two and a half stop bits.

The UART ports support automatic hardware flow control through the clear to send (CTS) input and request to send (RTS) output with programmable assertion FIFO levels.

To help support the local interconnect network (LIN) protocols, a special command causes the transmitter to queue a break command of programmable bit length into the transmit buffer. Similarly, the number of stop bits can be extended by a programmable inter-frame space.

The capabilities of the UARTs are further extended with support for the infrared data association (IrDA[®]) serial infrared physical layer link specification (SIR) protocol.

2-Wire Controller Interface (TWI)

The processor includes a 2-wire interface (TWI) module for providing a simple exchange method of control data between multiple devices. The TWI module is compatible with the widely used I²C bus standard. The TWI module offers the capabilities of simultaneous master and slave operation and support for both 7-bit addressing and multimedia data arbitration. The TWI interface utilizes two pins for transferring clock (TWI_SCL) and data (TWI_SDA) and supports the protocol at speeds up to 400k bits/sec. The TWI interface pins are compatible with 5 V logic levels.

Additionally, the TWI module is fully compatible with serial camera control bus (SCCB) functionality for easier control of various CMOS camera sensor devices.

Controller Area Network (CAN)

The CAN controller implements the CAN 2.0B (active) protocol. This protocol is an asynchronous communications protocol used in both industrial and automotive control systems. The CAN protocol is well suited for control applications due to its capability to communicate reliably over a network. This is because the protocol incorporates CRC checking, message error tracking, and fault node confinement.

The CAN controller offers the following features:

- 32 mailboxes (8 receive only, 8 transmit only, 16 configurable for receive or transmit).
- Dedicated acceptance masks for each mailbox.
- Additional data filtering on first two bytes.
- Support for both the standard (11-bit) and extended (29-bit) identifier (ID) message formats.
- Support for remote frames.
- Active or passive network support.
- Interrupts, including: TX complete, RX complete, error and global.

An additional crystal is not required to supply the CAN clock, as the CAN clock is derived from a system clock through a programmable divider.

10/100 Ethernet MAC (EMAC)

The processor can directly connect to a network by way of an embedded fast Ethernet media access controller (MAC) that supports both 10-BaseT (10M bits/sec) and 100-BaseT (100M bits/sec) operation. The 10/100 Ethernet MAC peripheral on the processor is fully compliant to the IEEE 802.3-2002 standard. It

ADSP-CM402F/CM403F/CM407F/CM408F/CM409F

provides programmable features designed to minimize supervision, bus use, or message processing by the rest of the processor system.

Some standard features are:

- Support for RMIIC protocols for external PHYs
- Full-duplex and half-duplex modes
- Media access management (in half-duplex operation)
- Flow control
- Station management: generation of MDC/MDIO frames for read-write access to PHY registers

Some advanced features are:

- Automatic checksum computation of IP header and IP payload fields of Rx frames
- Independent 32-bit descriptor-driven receive and transmit DMA channels
- Frame status delivery to memory through DMA, including frame completion semaphores for efficient buffer queue management in software
- Tx DMA support for separate descriptors for MAC header and payload to eliminate buffer copy operations
- Convenient frame alignment modes
- 47 MAC management statistics counters with selectable clear-on-read behavior and programmable interrupts on half maximum value
- Advanced power management
- Magic packet detection and wakeup frame filtering
- Support for 802.3Q tagged VLAN frames
- Programmable MDC clock rate and preamble suppression

IEEE 1588 Support

The IEEE 1588 standard is a precision clock synchronization protocol for networked measurement and control systems. The processor includes hardware support for IEEE 1588 with an integrated precision time protocol synchronization engine. This engine provides hardware assisted time stamping to improve the accuracy of clock synchronization between PTP nodes. The main features of the engine are:

- Support for both IEEE 1588-2002 and IEEE 1588-2008 protocol standards
- 64-bit hardware assisted time stamping for transmit and receive frames capable of up to 10 ns resolution
- Identification of PTP message type, version, and PTP payload in frames sent directly over Ethernet and transmission of the status
- Coarse and fine correction methods for system time update
- Alarm features: target time can be set to interrupt when system time reaches target time

- Pulse-Per-Second (PPS) output for physical representation of the system time. Flexibility to control the pulse-per-second output signal including control of start time, stop time, PPS output width and interval
- Automatic detection and time stamping of PTP messages over IPv4, IPv6, and Ethernet packets
- Multiple input clock sources (SCLK, RMIIC clock, external clock)
- Auxiliary snapshot to time stamp external events

USB 2.0 On-the-Go (OTG) Dual-Role Device Controller

The USB 2.0 on-the go (OTG) dual-role device controller provides a low-cost connectivity solution for the growing adoption of this bus standard in industrial applications, as well as consumer mobile devices such as cell phones, digital still cameras, and MP3 players. The USB 2.0 controller is a full-speed-only (FS) interface that allows these devices to transfer data using a point-to-point USB connection without the need for a PC host. The module can operate in a traditional USB peripheral-only mode as well as the host mode presented in the OTG supplement to the USB 2.0 specification.

CLOCK AND POWER MANAGEMENT

The processor provides three operating modes, each with a different performance/power profile. Control of clocking to each of the processor peripherals also reduces power consumption. See [Table 3](#) for a summary of the power settings for each mode.

Table 3. Power Settings

Mode	CGU PLL	CGU PLL Bypassed	f _{CCLK}	f _{SCLK}	Core Power
Full On	Enabled	No	Enabled	Enabled	On
Active	Enabled	Yes	Enabled	Enabled	On
	Disabled	Yes	Enabled	Enabled	On
Deep Sleep	Disabled	—	Disabled	Disabled	On

Crystal Oscillator (SYS_XTAL)

The processor can be clocked by an external crystal (see [Figure 8](#)), a sine wave input, or a buffered, shaped clock derived from an external clock oscillator. If an external clock is used, it should be a TTL compatible signal and must not be halted, changed, or operated below the specified frequency during normal operation. This signal is connected to the processor's SYS_CLKIN pin. When an external clock is used, the SYS_XTAL pin must be left unconnected. Alternatively, because the processor includes an on-chip oscillator circuit, an external crystal may be used.

For fundamental frequency operation, use the circuit shown in [Figure 8](#). A parallel-resonant, fundamental frequency, micro-processor grade crystal is connected across the SYS_CLKIN and XTAL pins. The on-chip resistance between SYS_CLKIN and the XTAL pin is in the 500 kΩ range. Further parallel resistors are typically not recommended.

ADSP-CM402F/CM403F/CM407F/CM408F/CM409F

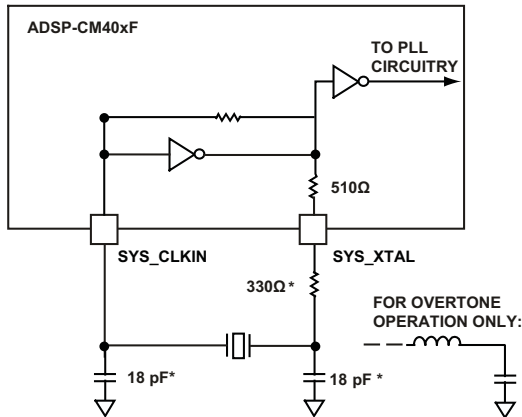

NOTE: VALUES MARKED WITH * MUST BE CUSTOMIZED, DEPENDING ON THE CRYSTAL AND LAYOUT. ANALYZE CAREFULLY. FOR FREQUENCIES ABOVE 33 MHz, THE SUGGESTED CAPACITOR VALUE OF 18pF SHOULD BE TREATED AS A MAXIMUM, AND THE SUGGESTED RESISTOR VALUE SHOULD BE REDUCED TO 0 Ω.

Figure 8. External Crystal Connection

The two capacitors and the 330 Ω series resistor shown in Figure 8 fine tune phase and amplitude of the sine frequency. The capacitor and resistor values shown in Figure 8 are typical values only. The capacitor values are dependent upon the crystal manufacturers' load capacitance recommendations and the PCB physical layout. The resistor value depends on the drive level specified by the crystal manufacturer. The user should verify the customized values based on careful investigations on multiple devices over temperature range.

A third-overtone crystal can be used for frequencies above 25 MHz. The circuit is then modified to ensure crystal operation only at the third overtone by adding a tuned inductor circuit as shown in Figure 8. A design procedure for third-overtone operation is discussed in detail in application note (EE-168) "Using Third Overtone Crystals with the ADSP-218x DSP" (www.analog.com/ee-168).

Oscillator Watchdog

A programmable oscillator watchdog unit is provided to allow verification of proper startup and harmonic mode of the external crystal. This allows the user to specify the expected frequency of oscillation, and to enable detection of non-oscillation and improper-oscillation faults. These events can be routed to the `SYS_FAULT` output pin and/or to cause a reset of the part.

Clock Generation Unit (CGU)

The clock generation unit (CGU) generates all on-chip clocks and synchronization signals. Multiplication factors are programmed to the PLLs to define the PLLCLK frequency. Programmable values divide the PLLCLK frequency to generate the core clock (CCLK), the system clocks (SCLK), and the output clock (OCLK). This is illustrated in Figure 10 on Page 64.

Writing to the CGU control registers does not affect the behavior of the PLL immediately. Registers are first programmed with a new value, and the PLL logic executes the changes so that it transitions smoothly from the current conditions to the new ones.

SYS_CLKIN oscillations start when power is applied to the VDD_EXT pins. The rising edge of SYS_HWRST can be applied as soon as all voltage supplies are within specifications (see [Operating Conditions on Page 64](#)), and SYS_CLKIN oscillations are stable.

Clock Out/External Clock

A SYS_CLKOUT output pin has programmable options to output divided-down versions of the on-chip clocks, including USB clocks. By default, the SYS_CLKOUT pin drives a buffered version of the SYS_CLKIN input. Clock generation faults (for example PLL unlock) may trigger a reset by hardware.

SYS_CLKOUT can be used to output one of several different clocks used on the processor. The clocks shown in Table 4 can be outputs from SYS_CLKOUT.

Table 4. SYS_CLKOUT Source and Divider Options

Clock Source	Divider
CCLK (Core Clock)	By 4
OCLK (Output Clock)	Programmable
USBCCLK	Programmable
CLKBUF	None, direct from SYS_CLKIN

Power Management

As shown in Table 5 and Figure 4 on Page 6, the processor requires three different power domains, VDD_INT, VDD_EXT, and VDD_ANA. By isolating the internal logic of the processor into its own power domain, separate from other I/O, the processor can take advantage of dynamic power management without affecting the other I/O devices. There are no sequencing requirements for the various power domains, but all domains must be powered according to the appropriate Specifications table for processor operating conditions; even if the feature/peripheral is not used.

The dynamic power management feature of the processor allows the processor's core clock frequency (f_{CCLK}) to be dynamically controlled.

Table 5. Power Domains

Power Domain	V _{DD} Range
All Internal Logic	V _{DD_INT}
Digital I/O	V _{DD_EXT}
Analog	V _{DD_ANA}

The power dissipated by a processor is largely a function of its clock frequency and the square of the operating voltage. For example, reducing the clock frequency by 25% results in a 25% reduction in dynamic power dissipation. For more information on power pins, see [Operating Conditions on Page 64](#).

ADSP-CM402F/CM403F/CM407F/CM408F/CM409F

Full-On Operating Mode—Maximum Performance

In the full-on mode, the PLL is enabled and is not bypassed, providing capability for maximum operational frequency. This is the execution state in which maximum performance can be achieved. The processor core and all enabled peripherals run at full speed.

For more information about PLL controls, see the “Dynamic Power Management” chapter in the *ADSP-CM40x Mixed-Signal Control Processor with ARM Cortex-M4 Hardware Reference*.

Deep Sleep Operating Mode—Maximum Dynamic Power Savings

The deep sleep mode maximizes dynamic power savings by disabling the clocks to the processor core and to all synchronous peripherals. Asynchronous peripherals may still be running but cannot access internal resources or external memory.

Voltage Regulation for VDD_INT

The internal voltage VDD_INT to the ADSP-CM40xF processors can be generated either by using an on-chip voltage regulator or by an external voltage regulator.

The VDD_INT of 1.2 V can be generated using the external I/O supply VDD_VREG of 3.3 V, which is then used to generate VDD_INT of 1.2 V. Figure 9 shows the external components required to complete the power management system for proper operation. For more details regarding component selection, refer to (EE-361) *ADSP-CM40x Power Supply Transistor Selection Guidelines* (www.analog.com/ee-361).

The internal voltage regulator can be bypassed and VDD_INT can be supplied using an external regulator. When an external regulator is used, VDD_VREG and VREG_BASE must be tied to ground for zero current consumption.

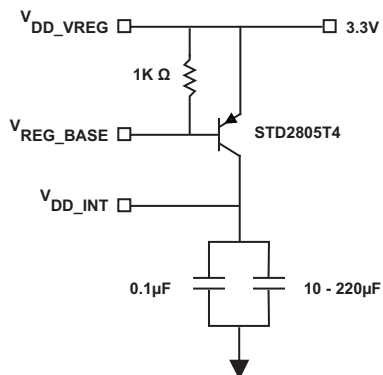

Figure 9. Internal Voltage Regulator Circuit

Reset Control Unit (RCU)

Reset is the initial state of the whole processor or of the core and is the result of a hardware or software triggered event. In this state, all control registers are set to their default values and functional units are idle. Exiting a core only reset starts with the core being ready to boot.

The reset control unit (RCU) controls how all the functional units enter and exit reset. Differences in functional requirements and clocking constraints define how reset signals are generated. Programs must guarantee that none of the reset functions puts the system into an undefined state or causes resources to stall.

From a system perspective reset is defined by both the reset target and the reset source as described below.

Target defined:

- Hardware Reset—All functional units are set to their default states without exception. History is lost.
- System Reset—All functional units except the RCU are set to their default states.

Source defined:

- Hardware Reset—The `SYS_HWRST` input signal is asserted active (pulled down).
- System Reset—May be triggered by software (writing to the `RCU_CTL` register) or by another functional unit such as the dynamic power management (DPM) unit or any of the system event controller (SEC), trigger routing unit (TRU), or emulator inputs.
- Trigger request (peripheral).

SYSTEM DEBUG UNIT (SDU)

The processor includes various features that allow for easy system debug. These are described in the following sections.

JTAG Debug and Serial Wire Debug Port (SWJ-DP)

SWJ-DP is a combined JTAG-DP and SW-DP that enables either a serial wire debug (SWD) or JTAG probe to be connected to a target. SWD signals share the same pins as JTAG. There is an auto detect mechanism that switches between JTAG-DP and SW-DP depending on which special data sequence is used the emulator pod transmits to the JTAG pins. The SWJ-DP behaves as a JTAG target if normal JTAG sequences are sent to it and as a single wire target if the SW_DP sequence is transmitted.

Embedded Trace Macrocell (ETM) and Instrumentation Trace Macrocell (ITM)

The ADSP-CM40xF processors support both embedded trace macrocell (ETM) and instrumentation trace macrocell (ITM). These both offer an optional debug component that enables logging of real-time instruction and data flow within the CPU core. This data is stored and read through special debugger pods that have the trace feature capability. The ITM is a single-data pin feature and the ETM is a 4-data pin feature.

System Watchpoint Unit (SWU)

The system watchpoint unit (SWU) is a single module which connects to a single system bus and provides for transaction monitoring. One SWU is attached to the bus going to each system slave. The SWU provides ports for all system bus address channel signals. Each SWU contains four match groups of

ADSP-CM402F/CM403F/CM407F/CM408F/CM409F

registers with associated hardware. These four SWU match groups operate independently, but share common event (interrupt and trigger) outputs.

DEVELOPMENT TOOLS

The ADSP-CM40xF processor is supported with a set of highly sophisticated and easy-to-use development tools for embedded applications. For more information, see the Analog Devices website.

ADDITIONAL INFORMATION

The following publications that describe the ADSP-CM40xF processors (and related processors) can be ordered from any Analog Devices sales office or accessed electronically on our website:

- *ADSP-CM40x Mixed-Signal Control Processor with ARM Cortex-M4 Hardware Reference*
- *ADSP-CM402F/CM403F/CM407F/CM408F/CM409F Anomaly Sheet*

This data sheet describes the ARM Cortex-M4 core and memory architecture used on the ADSP-CM40xF processor, but does not provide detailed programming information for the ARM processor. For more information about programming the ARM processor, visit the ARM Infocenter web page.

The applicable documentation for programming the ARM Cortex-M4 processor include:

- *Cortex[®]-M4 Devices Generic User Guide*
- *CoreSight[™] ETM[™]-M4 Technical Reference Manual*
- *Cortex[®]-M4 Technical Reference Manual*

RELATED SIGNAL CHAINS

A signal chain is a series of signal-conditioning electronic components that receive input (data acquired from sampling either real-time phenomena or from stored data) in tandem, with the output of one portion of the chain supplying input to the next. Signal chains are often used in signal processing applications to gather and process data or to apply system controls based on analysis of real-time phenomena.

Analog Devices eases signal processing system development by providing signal processing components that are designed to work together well. A tool for viewing relationships between specific applications and related components is available on the www.analog.com website.

The application signal chains page in the Circuits from the Lab[®] site (<http://www.analog.com/circuits>) provides:

- Graphical circuit block diagram presentation of signal chains for a variety of circuit types and applications
- Drill down links for components in each chain to selection guides and application information
- Reference designs applying best practice design techniques

SECURITY FEATURES DISCLAIMER

To our knowledge, the Security Features, when used in accordance with the data sheet and hardware reference manual specifications, provide a secure method of implementing code and data safeguards. However, Analog Devices does not guarantee that this technology provides absolute security.

ACCORDINGLY, ANALOG DEVICES HEREBY DISCLAIMS ANY AND ALL EXPRESS AND IMPLIED WARRANTIES THAT THE SECURITY FEATURES CANNOT BE BREACHED, COMPROMISED, OR OTHERWISE CIRCUMVENTED AND IN NO EVENT SHALL ANALOG DEVICES BE LIABLE FOR ANY LOSS, DAMAGE, DESTRUCTION, OR RELEASE OF DATA, INFORMATION, PHYSICAL PROPERTY, OR INTELLECTUAL PROPERTY.

ADSP-CM402F/CM403F/CM407F/CM408F/CM409F

ADSP-CM40xF DETAILED SIGNAL DESCRIPTIONS

Table 6 provides a detailed description of each pin.

Table 6. ADSP-CM40xF Detailed Signal Description

Signal Name	Direction	Description
ADC_VINn	Input	Channel nn. Single-Ended Analog Input for ADCs. nn = 00 to 11 for each ADC
BYP_An		On-chip Analog Power Regulation Bypass Filter Node for ADC. Connect to decoupling capacitors. n = 0, 1
BYP_D0		On-chip Digital Power Regulation Bypass Filter Node for Analog Subsystem. Connect to decoupling capacitors.
CAN_RX	Input	CAN Receive. Typically an external CAN transceiver's RX output.
CAN_TX	Output	CAN Transmit. Typically an external CAN transceiver's TX input.
CNT_OUTA	Output	Counter Output Divider A. Frequency scaled output in Quadrature encoder mode of GP Counter
CNT_OUTB	Output	Counter Output Divider B. Frequency scaled output in Quadrature encoder mode of GP Counter
CNT_DG	Input	CNT Count Down and Gate. Depending on the mode of operation this input acts either as a count down signal or a gate signal. Count Down: This input causes the GP counter to decrement. Gate: Stops the GP counter from incrementing or decrementing.
CNT_UD	Input	Count Up and Direction. Depending on the mode of operation this input acts either as a count up signal or a direction signal. Count Up: This input causes the GP counter to increment. Direction: Selects whether the GP counter is incrementing or decrementing.
CNT_ZM	Input	Count Zero Marker. Input that connects to the zero marker output of a rotary device or detects the pressing of a push button.
CPTMR_INn	Input	Capture Timer Input Pins. n = 0, 1, 2
DACn_VOUT	Output	DAC Output. Analog voltage output. n = 0, 1
ETH_CRIS	Input	EMAC Carrier Sense. Multiplexed on alternate clock cycles. CRS: Asserted by the PHY when either the transmit or receive medium is not idle. De-asserted when both are idle. RXDV: Asserted by the PHY when the data on RXDn is valid.
ETH_MDC	Output	EMAC Management Channel Clock. Clocks the MDC input of the PHY.
ETH_MDIO	I/O	EMAC Management Channel Serial Data. Bidirectional data bus for PHY control.
ETH_PTPAUXIN	Input	EMAC PTP Auxiliary Trigger Input. Assert this signal to take an auxiliary snapshot of the time and store it in the auxiliary time stamp FIFO.
ETH_PTPCLKIN	Input	EMAC PTP Clock Input. Optional external PTP clock input.
ETH_PTPPPS	Output	EMAC PTP Pulse-Per-Second Output. When the Advanced Time Stamp feature is enabled, this signal is asserted based on the PPS mode selected. Otherwise, PTPPPS is asserted every time the seconds counter is incremented.
ETH_REFCLK	Input	EMAC Reference Clock. Externally supplied Ethernet clock.
ETH_RXDn	Input	EMAC Receive Data n. Receive data bus. n = 0, 1
ETH_TXDn	Output	EMAC Transmit Data n. Transmit data bus. n = 0, 1
ETH_TXEN	I/O	EMAC Transmit Enable. When asserted indicates that the data on TXDn is valid.
JTG_SWCLK	I/O	Serial Wire Clock. Clocks data into and out of the target during debug.
JTG_SWDIO	I/O	Serial Wire Data IO. Sends and receives serial data to and from the target during debug.
JTG_SWO	Output	Serial Wire Out. Provides trace data to the emulator.
JTG_TCK	Input	JTAG Clock. JTAG test access port clock.
JTG_TDI	Input	JTAG Serial Data In. JTAG test access port data input.
JTG_TDO	Output	JTAG Serial Data Out. JTAG test access port data output.
JTG_TMS	Input	JTAG Mode Select. JTAG test access port mode select.

ADSP-CM402F/CM403F/CM407F/CM408F/CM409F

Table 6. ADSP-CM40xF Detailed Signal Description (Continued)

Signal Name	Direction	Description
JTG_TRST	Input	JTAG Reset. JTAG test access port reset.
Px_nn	I/O	Position n. General purpose input/output. See the GP Ports chapter in the processor hardware reference for programming information.
PWM_AH	Output	PWM Channel A High Side. High side drive signal.
PWM_AL	Output	PWM Channel A Low Side. Low side drive signal.
PWM_BH	Output	PWM Channel B High Side. High side drive signal.
PWM_BL	Output	PWM Channel B Low Side. Low side drive signal.
PWM_CH	Output	PWM Channel C High Side. High side drive signal.
PWM_CL	Output	PWM Channel C Low Side. Low side drive signal.
PWM_DH	Output	PWM Channel D High Side. High side drive signal.
PWM_DL	Output	PWM Channel D Low Side. Low side drive signal.
PWM_SYNC	I/O	PWM Synchronization signal. This is an input pin when PWM is configured to receive external sync signal. It is an output pin when PWM Sync is generated internally.
PWM_TRIPn	Input	PWM Trip Input. When asserted the selected PWM channel outputs are shut down immediately.
REFCAP	Analog	Output of BandGap Generator Filter Node
SINC_CLKn	Output	SINC Clock n. n = 0, 1
SINC_Dn	Input	SINC Data n. n = 0 to 3
SMC_Ann	Output	SMC Address n. Address bus. n = 0 to 24
SMC_ABE \overline{n}	Output	SMC Byte Enable n. Indicates whether the lower or upper byte of a memory is being accessed. When an asynchronous write is made to the upper byte of a 16-bit memory, SMC_ABE1 = 0 and SMC_ABE0 = 1. When an asynchronous write is made to the lower byte of a 16-bit memory, SMC_ABE1 = 1 and SMC_ABE0 = 0.
SMC_AMSn	Output	SMC Memory Select n. Typically connects to the chip select of a memory device. n = 0, 1, 2, 3
SMC_AOE	Output	SMC Output Enable. Asserts at the beginning of the setup period of a read access.
SMC_ARDY	Input	SMC Asynchronous Ready. Flow control signal used by memory devices to indicate to the SMC when further transactions may proceed.
SMC_ARE	Output	SMC Read Enable. Asserts at the beginning of a read access.
SMC_AWE	Output	SMC Write Enable. Asserts for the duration of a write access period.
SMC_Dnn	I/O	SMC Data n. Bidirectional data bus. n = 0 to 15
SPI_CLK	I/O	SPI Clock. Input in slave mode, output in master mode.
SPI_D2	I/O	SPI Data 2. Used to transfer serial data in quad mode. Open drain in ODM mode.
SPI_D3	I/O	SPI Data 3. Used to transfer serial data in quad mode. Open drain in ODM mode.
SPI_MISO	I/O	SPI Master In, Slave Out. Used to transfer serial data. Operates in the same direction as SPI_MOSI in dual and quad modes. Open drain in ODM mode.
SPI_MOSI	I/O	SPI Master Out, Slave In. Used to transfer serial data. Operates in the same direction as SPI_MISO in dual and quad modes. Open drain in ODM mode.
SPI_RDY	I/O	SPI Ready. Optional flow signal to hold-off faster masters. Output in slave mode, input in master mode.
SPI_SELn	Output	SPI Slave Select Output n. Used in master mode to enable the desired slave.
SPI_SS	Input	SPI Slave Select Input. Slave mode: acts as the slave select input. Master mode: optionally serves as an error detection input for the SPI when there are multiple masters.
SPT_ACLK	I/O	SPORT A Channel Clock. Data and frame sync are driven/sampled with respect to this clock. This signal can be either internally or externally generated.
SPT_ADO	I/O	SPORT A Channel Data 0. Primary bidirectional data I/O. This signal can be configured as an output to transmit serial data, or as an input to receive serial data.
SPT_AD1	I/O	SPORT A Channel Data 1. Secondary bidirectional data I/O. This signal can be configured as an output to transmit serial data, or as an input to receive serial data.

ADSP-CM402F/CM403F/CM407F/CM408F/CM409F

Table 6. ADSP-CM40xF Detailed Signal Description (Continued)

Signal Name	Direction	Description
SPT_AFS	I/O	SPORT A Channel Frame Sync. The frame sync pulse initiates shifting of serial data. This signal is either generated internally or externally.
SPT_ATDV	Output	SPORT A Channel Transmit Data Valid. This signal is optional and only active when SPORT is configured in multi-channel transmit mode. It is asserted during enabled slots.
SPT_BCLK	I/O	SPORT B Channel Clock. Data and frame sync are driven/sampled with respect to this clock. This signal can be either internally or externally generated.
SPT_BD0	I/O	SPORT B Channel Data 0. Primary bidirectional data I/O. This signal can be configured as an output to transmit serial data, or as an input to receive serial data.
SPT_BD1	I/O	SPORT B Channel Data 1. Secondary bidirectional data I/O. This signal can be configured as an output to transmit serial data, or as an input to receive serial data.
SPT_BFS	I/O	SPORT B Channel Frame Sync. The frame sync pulse initiates shifting of serial data. This signal is either generated internally or externally.
SPT_BTDV	Output	SPORT B Channel Transmit Data Valid. This signal is optional and only active when SPORT is configured in multi-channel transmit mode. It is asserted during enabled slots.
SYS_BMODEn	Input	Boot Mode Control n. Selects the boot mode of the processor. n = 0, 1
SYS_CLKIN	Input	Processor Clock/Crystal Input. Connect to an external clock source or crystal.
SYS_CLKOUT	Output	Processor Clock Output. Outputs internal clocks. Clocks may be divided down. See the CGU chapter in the processor hardware reference for more details.
SYS_DSWAKEn	Input	System Deep Sleep Wakeup inputs. n = 0 to 3
$\overline{\text{SYS_FAULT}}$	Output	System Fault. Indicates system fault.
$\overline{\text{SYS_HWRST}}$	Input	Processor Hardware Reset Control. Resets the device when asserted.
$\overline{\text{SYS_NMI}}$	Input	Non-maskable Interrupt. See the processor hardware and programming references for more details.
$\overline{\text{SYS_RESOUT}}$	Output	Processor Reset Output. Indicates that the device is in the reset state.
SYS_XTAL	Output	System Crystal Output. Drives an external crystal. Must be left unconnected if an external clock is driving CLKIN.
TM_ACIn	Input	GP Timer Alternate Capture Input n. Provides an additional input for GP Timers in WIDCAP, WATCHDOG, and PININT modes. n = 0 to 5
TM_ACLKn	Input	GP Timer Alternate Clock n. Provides an additional time base for use by an individual timer. n = 0 to 5
TM_CLK	Input	GP Timer Clock. Provides an additional global time base for use by all the GP timers.
TM_TMRn	I/O	GP Timer Timer n. The main input/output signal for each timer. n = 0 to 7. In PWM OUT mode, output is driven on this pin. In Width capture mode, it acts as input and Timer measures width and/or period of incoming signal on this pin. In EXTCLK mode, Timer counts number of incoming signal edges on this pin.
TRACE_CLK	Output	Embedded Trace Module Clock. Reference clock for the Trace Unit.
TRACE_Dn	Output	Embedded Trace Module Data n. Output data for clocked modes and changes on both edges of TRACE_CLK. n = 0 to 3
TWI_SCL	I/O	TWI Serial Clock. Clock output when master, clock input when slave. Compatible with I ² C bus standard.
TWI_SDA	I/O	TWI Serial Data. Receives or transmits data. Compatible with I ² C bus standard.
$\overline{\text{UART_CTS}}$	Input	UART Clear to Send. Input Hardware Flow control signal. Transmitter initiates the transfer only when this signal is active.
$\overline{\text{UART_RTS}}$	Output	UART Request to Send. Output Hardware Flow control signal. Receiver activates this signal when it is ready to receive new transfers.
$\overline{\text{UART_RX}}$	Input	UART Receive. Receive input. Typically connects to a transceiver that meets the electrical requirements of the device being communicated with.
$\overline{\text{UART_TX}}$	Output	UART Transmit. Transmit output. Typically connects to a transceiver that meets the electrical requirements of the device being communicated with.
USB_DM	I/O	USB Data -. Bidirectional differential data line.
USB_DP	I/O	USB Data +. Bidirectional differential data line.

ADSP-CM402F/CM403F/CM407F/CM408F/CM409F

Table 6. ADSP-CM40xF Detailed Signal Description (Continued)

Signal Name	Direction	Description
USB_ID	Input	USB OTG ID. Senses whether the controller is a host or device. This signal is pulled low when an A-type plug is sensed (signifying that the USB controller is the A device), but the input is high when a B-type plug is sensed (signifying that the USB controller is the B device).
USB_VBC	Output	USB VBUS Control. Controls an external voltage source to supply VBUS when in host mode. May be configured as open drain. Polarity is configurable as well.
USB_VBUS	I/O	USB Bus Voltage. Connects to bus voltage in host and device modes.
VREFn	I/O	Voltage Reference for ADC. When internal reference is selected for ADC, the VREF pin is used for connecting bypass caps. When external reference is selected, an external reference device should be connected to these pins to supply the external reference voltage. n=0,1.
VREG_BASE	Output	Voltage Regulator Base Node. Connected to Base of PNP transistor when using internal VDD_INT reference.

ADSP-CM402F/CM403F/CM407F/CM408F/CM409F

ADSP-CM402F/ADSP-CM403F 120-LEAD LQFP SIGNAL DESCRIPTIONS

The processor's pin definitions are shown in [Table 7](#). The columns in this table provide the following information:

- **Signal Name:** The Signal Name column in the table includes the signal name for every pin and (where applicable) the GPIO multiplexed pin function for every pin.
- **Description:** The Description column in the table provides a verbose (descriptive) name for the signal.
- **General-Purpose Port:** The Port column in the table shows whether or not the signal is multiplexed with other signals on a general-purpose I/O port pin.
- **Pin Name:** The Pin Name column in the table identifies the name of the package pin (at power on reset) on which the signal is located (if a single function pin) or is multiplexed (if a general-purpose I/O pin).

Table 7. ADSP-CM402F/ADSP-CM403F 120-Lead LQFP Signal Descriptions

Signal Name	Description	Port	Pin Name
ADC0_VIN00	Channel 0 Single-Ended Analog Input for ADC0	Not Muxed	ADC0_VIN00
ADC0_VIN01	Channel 1 Single-Ended Analog Input for ADC0	Not Muxed	ADC0_VIN01
ADC0_VIN02	Channel 2 Single-Ended Analog Input for ADC0	Not Muxed	ADC0_VIN02
ADC0_VIN03	Channel 3 Single-Ended Analog Input for ADC0	Not Muxed	ADC0_VIN03
ADC0_VIN04	Channel 4 Single-Ended Analog Input for ADC0	Not Muxed	ADC0_VIN04
ADC0_VIN05	Channel 5 Single-Ended Analog Input for ADC0	Not Muxed	ADC0_VIN05
ADC0_VIN06	Channel 6 Single-Ended Analog Input for ADC0	Not Muxed	ADC0_VIN06
ADC0_VIN07	Channel 7 Single-Ended Analog Input for ADC0	Not Muxed	ADC0_VIN07
ADC0_VIN08	Channel 8 Single-Ended Analog Input for ADC0	Not Muxed	ADC0_VIN08
ADC0_VIN09	Channel 9 Single-Ended Analog Input for ADC0	Not Muxed	ADC0_VIN09
ADC0_VIN10	Channel 10 Single-Ended Analog Input for ADC0	Not Muxed	ADC0_VIN10
ADC0_VIN11	Channel 11 Single-Ended Analog Input for ADC0	Not Muxed	ADC0_VIN11
ADC1_VIN00	Channel 0 Single-Ended Analog Input for ADC1	Not Muxed	ADC1_VIN00
ADC1_VIN01	Channel 1 Single-Ended Analog Input for ADC1	Not Muxed	ADC1_VIN01
ADC1_VIN02	Channel 2 Single-Ended Analog Input for ADC1	Not Muxed	ADC1_VIN02
ADC1_VIN03	Channel 3 Single-Ended Analog Input for ADC1	Not Muxed	ADC1_VIN03
ADC1_VIN04	Channel 4 Single-Ended Analog Input for ADC1	Not Muxed	ADC1_VIN04
ADC1_VIN05	Channel 5 Single-Ended Analog Input for ADC1	Not Muxed	ADC1_VIN05
ADC1_VIN06	Channel 6 Single-Ended Analog Input for ADC1	Not Muxed	ADC1_VIN06
ADC1_VIN07	Channel 7 Single-Ended Analog Input for ADC1	Not Muxed	ADC1_VIN07
ADC1_VIN08	Channel 8 Single-Ended Analog Input for ADC1	Not Muxed	ADC1_VIN08
ADC1_VIN09	Channel 9 Single-Ended Analog Input for ADC1	Not Muxed	ADC1_VIN09
ADC1_VIN10	Channel 10 Single-Ended Analog Input for ADC1	Not Muxed	ADC1_VIN10
ADC1_VIN11	Channel 11 Single-Ended Analog Input for ADC1	Not Muxed	ADC1_VIN11
BYP_A0	On-chip Analog Power Regulation Bypass Filter Node for ADC0 (see recommended bypass - Figure 4 on Page 6)	Not Muxed	BYP_A0
BYP_A1	On-chip Analog Power Regulation Bypass Filter Node for ADC1 (see recommended bypass - Figure 4 on Page 6)	Not Muxed	BYP_A1
BYP_D0	On-chip Digital Power Regulation Bypass Filter Node for Analog Subsystem (see recommended bypass - Figure 4 on Page 6)	Not Muxed	BYP_D0
CAN0_RX	CAN0 Receive	B	PB_15
CAN0_TX	CAN0 Transmit	C	PC_00
CAN1_RX	CAN1 Receive	B	PB_10
CAN1_TX	CAN1 Transmit	B	PB_11
CNT0_DG	CNT0 Count Down and Gate	B	PB_02
CNT0_OUTA	CNT0 Output Divider A	B	PB_13

ADSP-CM402F/CM403F/CM407F/CM408F/CM409F

Table 7. ADSP-CM402F/ADSP-CM403F 120-Lead LQFP Signal Descriptions (Continued)

Signal Name	Description	Port	Pin Name
CNT0_OUTB	CNT0 Output Divider B	B	PB_14
CNT0_UD	CNT0 Count Up and Direction	B	PB_01
CNT0_ZM	CNT0 Count Zero Marker	B	PB_00
CNT1_DG	CNT1 Count Down and Gate	B	PB_05
CNT1_UD	CNT1 Count Up and Direction	B	PB_04
CNT1_ZM	CNT1 Count Zero Marker	B	PB_03
CPTMR0_IN0	CPTMR0 Capture Timer0 Input 0	B	PB_07
CPTMR0_IN1	CPTMR0 Capture Timer0 Input 1	B	PB_08
CPTMR0_IN2	CPTMR0 Capture Timer0 Input 2	B	PB_09
DAC0_VOUT	Analog Voltage Output 0	Not Muxed	DAC0_VOUT
DAC1_VOUT	Analog Voltage Output 1	Not Muxed	DAC1_VOUT
GND	Digital Ground	Not Muxed	GND
GND_ANA0	Analog Ground return for VDD_ANA0 (see recommended bypass - Figure 4 on Page 6)	Not Muxed	GND_ANA0
GND_ANA1	Analog Ground return for VDD_ANA1 (see recommended bypass - Figure 4 on Page 6)	Not Muxed	GND_ANA1
GND_ANA2	Analog Ground (see recommended bypass - Figure 4 on Page 6)	Not Muxed	GND_ANA2
GND_ANA3	Analog Ground (see recommended bypass - Figure 4 on Page 6)	Not Muxed	GND_ANA3
GND_VREF0	Ground return for VREF0 (see recommended bypass filter - Figure 4 on Page 6)	Not Muxed	GND_VREF0
GND_VREF1	Ground return for VREF1 (see recommended bypass filter - Figure 4 on Page 6)	Not Muxed	GND_VREF1
JTG_TCK/SWCLK	JTAG Clock/Serial Wire Clock	Not Muxed	JTG_TCK/SWCLK
JTG_TDI	JTAG Serial Data In	Not Muxed	JTG_TDI
JTG_TDO/SWO	JTAG Serial Data Out/Serial Wire Trace Output	Not Muxed	JTG_TDO/SWO
JTG_TMS/SWDIO	JTAG Mode Select/Serial Wire Debug Data I/O	Not Muxed	JTG_TMS/SWDIO
$\overline{\text{JTG_TRST}}$	JTAG Reset	Not Muxed	$\overline{\text{JTG_TRST}}$
PA_00-PA_15	Port A Positions 0 – 15	A	PA_00 – PA_15
PB_00-PB_15	Port B Positions 0 – 15	B	PB_00 – PB_15
PC_00-PC_07	Port C Positions 0 – 7	C	PC_00 – PC_07
PWM0_AH	PWM0 Channel A High Side	A	PA_02
PWM0_AL	PWM0 Channel A Low Side	A	PA_03
PWM0_BH	PWM0 Channel B High Side	A	PA_04
PWM0_BL	PWM0 Channel B Low Side	A	PA_05
PWM0_CH	PWM0 Channel C High Side	A	PA_06
PWM0_CL	PWM0 Channel C Low Side	A	PA_07
PWM0_DH	PWM0 Channel D High Side	B	PB_00
PWM0_DL	PWM0 Channel D Low Side	B	PB_01
PWM0_SYNC	PWM0 Sync	A	PA_00
$\overline{\text{PWM0_TRIP0}}$	PWM0 Trip Input 0	A	PA_01
PWM1_AH	PWM1 Channel A High Side	A	PA_12
PWM1_AL	PWM1 Channel A Low Side	A	PA_13
PWM1_BH	PWM1 Channel B High Side	A	PA_14
PWM1_BL	PWM1 Channel B Low Side	A	PA_15
PWM1_CH	PWM1 Channel C High Side	A	PA_08
PWM1_CL	PWM1 Channel C Low Side	A	PA_09
PWM1_DH	PWM1 Channel D High Side	B	PB_02

ADSP-CM402F/CM403F/CM407F/CM408F/CM409F

Table 7. ADSP-CM402F/ADSP-CM403F 120-Lead LQFP Signal Descriptions (Continued)

Signal Name	Description	Port	Pin Name
PWM1_DL	PWM1 Channel D Low Side	B	PB_03
PWM1_SYNC	PWM1 Sync	A	PA_10
PWM1_TRIP0	PWM1 Trip Input 0	A	PA_11
PWM2_AH	PWM2 Channel A High Side	B	PB_06
PWM2_AL	PWM2 Channel A Low Side	B	PB_07
PWM2_BH	PWM2 Channel B High Side	B	PB_08
PWM2_BL	PWM2 Channel B Low Side	B	PB_09
PWM2_CH	PWM2 Channel C High Side	C	PC_03
PWM2_CL	PWM2 Channel C Low Side	C	PC_04
PWM2_DH	PWM2 Channel D High Side	C	PC_05
PWM2_DL	PWM2 Channel D Low Side	C	PC_06
PWM2_SYNC	PWM2 Sync	B	PB_04
PWM2_TRIP0	PWM2 Trip Input 0	B	PB_05
REFCAP	Output of BandGap Generator Filter Node (see recommended bypass filter - Figure 4 on Page 6)	Not Muxed	REFCAP
SINC0_CLK0	SINC0 Clock 0	B	PB_10
SINC0_CLK1	SINC0 Clock 1	C	PC_07
SINC0_D0	SINC0 Data 0	B	PB_11
SINC0_D1	SINC0 Data 1	B	PB_12
SINC0_D2	SINC0 Data 2	B	PB_13
SINC0_D3	SINC0 Data 3	B	PB_14
SMC0_A01	SMC0 Address 1	B	PB_13
SMC0_A02	SMC0 Address 2	B	PB_14
SMC0_A03	SMC0 Address 3	B	PB_15
SMC0_A04	SMC0 Address 4	C	PC_00
SMC0_A05	SMC0 Address 5	C	PC_01
SMC0_AMS0	SMC0 Memory Select 0	B	PB_11
SMC0_AMS2	SMC0 Memory Select 2	A	PA_07
SMC0_AOE	SMC0 Output Enable	B	PB_12
SMC0_ARDY	SMC0 Asynchronous Ready	B	PB_08
SMC0_ARE	SMC0 Read Enable	B	PB_09
SMC0_AWE	SMC0 Write Enable	B	PB_10
SMC0_D00	SMC0 Data 0	A	PA_08
SMC0_D01	SMC0 Data 1	A	PA_09
SMC0_D02	SMC0 Data 2	A	PA_10
SMC0_D03	SMC0 Data 3	A	PA_11
SMC0_D04	SMC0 Data 4	A	PA_12
SMC0_D05	SMC0 Data 5	A	PA_13
SMC0_D06	SMC0 Data 6	A	PA_14
SMC0_D07	SMC0 Data 7	A	PA_15
SMC0_D08	SMC0 Data 8	B	PB_00
SMC0_D09	SMC0 Data 9	B	PB_01
SMC0_D10	SMC0 Data 10	B	PB_02
SMC0_D11	SMC0 Data 11	B	PB_03
SMC0_D12	SMC0 Data 12	B	PB_04
SMC0_D13	SMC0 Data 13	B	PB_05

ADSP-CM402F/CM403F/CM407F/CM408F/CM409F

Table 7. ADSP-CM402F/ADSP-CM403F 120-Lead LQFP Signal Descriptions (Continued)

Signal Name	Description	Port	Pin Name
SMC0_D14	SMC0 Data 14	B	PB_06
SMC0_D15	SMC0 Data 15	B	PB_07
SPIO_CLK	SPIO Clock	C	PC_03
SPIO_D2	SPIO Data 2	B	PB_10
SPIO_D3	SPIO Data 3	B	PB_11
SPIO_MISO	SPIO Master In, Slave Out	C	PC_04
SPIO_MOSI	SPIO Master Out, Slave In	C	PC_05
SPIO_RDY	SPIO Ready	C	PC_02
$\overline{\text{SPIO_SEL1}}$	SPIO Slave Select Output 1	C	PC_06
$\overline{\text{SPIO_SEL2}}$	SPIO Slave Select Output 2	B	PB_13
$\overline{\text{SPIO_SEL3}}$	SPIO Slave Select Output 3	B	PB_14
$\overline{\text{SPIO_SS}}$	SPIO Slave Select Input	B	PB_14
SPT0_ACLK	SPORT0 Channel A Clock	B	PB_00
SPT0_AD0	SPORT0 Channel A Data 0	B	PB_02
SPT0_AD1	SPORT0 Channel A Data 1	B	PB_03
SPT0_AFS	SPORT0 Channel A Frame Sync	B	PB_01
SPT0_ATDV	SPORT0 Channel A Transmit Data Valid	B	PB_04
SPT1_ACLK	SPORT1 Channel A Clock	A	PA_00
SPT1_AD0	SPORT1 Channel A Data 0	A	PA_02
SPT1_AD1	SPORT1 Channel A Data 1	A	PA_03
SPT1_AFS	SPORT1 Channel A Frame Sync	A	PA_01
SPT1_ATDV	SPORT1 Channel A Transmit Data Valid	B	PB_15
SPT1_BCLK	SPORT1 Channel B Clock	A	PA_04
SPT1_BD0	SPORT1 Channel B Data 0	A	PA_06
SPT1_BD1	SPORT1 Channel B Data 1	A	PA_07
SPT1_BFS	SPORT1 Channel B Frame Sync	A	PA_05
SPT1_BTDV	SPORT1 Channel B Transmit Data Valid	C	PC_00
SYS_BMODE0	Boot Mode Control 0	Not Muxed	SYS_BMODE0
SYS_BMODE1	Boot Mode Control 1	Not Muxed	SYS_BMODE1
SYS_CLKIN	Clock/Crystal Input	Not Muxed	SYS_CLKIN
SYS_CLKOUT	Processor Clock Output	Not Muxed	SYS_CLKOUT
SYS_DSWAKE0	Deep Sleep Wake-up 0	C	PC_06
SYS_DSWAKE1	Deep Sleep Wake-up 1	C	PC_07
SYS_DSWAKE2	Deep Sleep Wake-up 2	B	PB_14
SYS_DSWAKE3	Deep Sleep Wake-up 3	B	PB_13
$\overline{\text{SYS_FAULT}}$	System Fault Output	Not Muxed	$\overline{\text{SYS_FAULT}}$
$\overline{\text{SYS_HWRST}}$	Processor Hardware Reset Control	Not Muxed	$\overline{\text{SYS_HWRST}}$
$\overline{\text{SYS_NMI}}$	Nonmaskable Interrupt	Not Muxed	$\overline{\text{SYS_NMI}}$
$\overline{\text{SYS_RESOUT}}$	Reset Output	Not Muxed	$\overline{\text{SYS_RESOUT}}$
SYS_XTAL	Crystal Output	Not Muxed	SYS_XTAL
TM0_AC11	TIMER0 Alternate Capture Input 1	B	PB_10
TM0_AC12	TIMER0 Alternate Capture Input 2	B	PB_08
TM0_AC13	TIMER0 Alternate Capture Input 3	B	PB_12
TM0_AC14	TIMER0 Alternate Capture Input 4	B	PB_15
TM0_AC15	TIMER0 Alternate Capture Input 5	C	PC_01
TM0_ACLK0	TIMER0 Alternate Clock 0	B	PB_13

ADSP-CM402F/CM403F/CM407F/CM408F/CM409F

Table 7. ADSP-CM402F/ADSP-CM403F 120-Lead LQFP Signal Descriptions (Continued)

Signal Name	Description	Port	Pin Name
TM0_ACLK1	TIMER0 Alternate Clock 1	B	PB_11
TM0_ACLK2	TIMER0 Alternate Clock 2	A	PA_11
TM0_ACLK3	TIMER0 Alternate Clock 3	A	PA_10
TM0_ACLK4	TIMER0 Alternate Clock 4	A	PA_09
TM0_ACLK5	TIMER0 Alternate Clock 5	A	PA_08
TM0_CLK	TIMER0 Clock	B	PB_06
TM0_TMR0	TIMER0 Timer 0	B	PB_07
TM0_TMR1	TIMER0 Timer 1	B	PB_08
TM0_TMR2	TIMER0 Timer 2	B	PB_09
TM0_TMR3	TIMER0 Timer 3	A	PA_15
TM0_TMR4	TIMER0 Timer 4	A	PA_12
TM0_TMR5	TIMER0 Timer 5	A	PA_13
TM0_TMR6	TIMER0 Timer 6	A	PA_14
TM0_TMR7	TIMER0 Timer 7	B	PB_05
TRACE_CLK	Embedded Trace Module Clock	B	PB_00
TRACE_D00	Embedded Trace Module Data 0	B	PB_01
TRACE_D01	Embedded Trace Module Data 1	B	PB_02
TRACE_D02	Embedded Trace Module Data 2	B	PB_03
TRACE_D03	Embedded Trace Module Data 3	C	PC_02
TWI0_SCL	TWI0 Serial Clock	Not Muxed	TWI0_SCL
TWI0_SDA	TWI0 Serial Data	Not Muxed	TWI0_SDA
UART0_CTS	UART0 Clear to Send	B	PB_05
UART0_RTS	UART0 Request to Send	B	PB_04
UART0_RX	UART0 Receive	C	PC_01
UART0_TX	UART0 Transmit	C	PC_02
UART1_CTS	UART1 Clear to Send	A	PA_11
UART1_RTS	UART1 Request to Send	C	PC_07
UART1_RX	UART1 Receive	B	PB_08
UART1_RX	UART1 Receive	B	PB_15
UART1_TX	UART1 Transmit	B	PB_09
UART1_TX	UART1 Transmit	C	PC_00
UART2_RX	UART2 Receive	B	PB_12
UART2_TX	UART2 Transmit	C	PC_07
VDD_ANA0	Analog Voltage Domain (see recommended bypass - Figure 4 on Page 6)	Not Muxed	VDD_ANA0
VDD_ANA1	Analog Voltage Domain (see recommended bypass - Figure 4 on Page 6)	Not Muxed	VDD_ANA1
VDD_EXT	External Voltage Domain	Not Muxed	VDD_EXT
VDD_INT	Internal Voltage Domain	Not Muxed	VDD_INT
VDD_VREG	VREG Supply Voltage	Not Muxed	VDD_VREG
VREF0	Voltage Reference for ADC0. Default configuration is Output (see recommended bypass - Figure 4 on Page 6)	Not Muxed	VREF0
VREF1	Voltage Reference for ADC1. Default configuration is Output (see recommended bypass - Figure 4 on Page 6)	Not Muxed	VREF1
VREG_BASE	Voltage Regulator Base Node	Not Muxed	VREG_BASE

ADSP-CM402F/CM403F/CM407F/CM408F/CM409F

ADSP-CM402F/ADSP-CM403F GPIO MULTIPLEXING FOR 120-LEAD LQFP

Table 8 through Table 10 identify the pin functions that are multiplexed on the general-purpose I/O pins of the 120-lead LQFP package.

Table 8. Signal Multiplexing for Port A (120-Lead LQFP)

Signal Name	Multiplexed Function 0	Multiplexed Function 1	Multiplexed Function 2	Multiplexed Function 3	Multiplexed Function Input Tap
PA_00	PWM0_SYNC		SPT1_ACLK		
PA_01	PWM0_TRIP0		SPT1_AFS		
PA_02	PWM0_AH		SPT1_AD0		
PA_03	PWM0_AL		SPT1_AD1		
PA_04	PWM0_BH		SPT1_BCLK		
PA_05	PWM0_BL		SPT1_BFS		
PA_06	PWM0_CH		SPT1_BD0		
PA_07	PWM0_CL	SMC0_AMS2	SPT1_BD1		
PA_08	PWM1_CH		SMC0_D00		TM0_ACLK5
PA_09	PWM1_CL		SMC0_D01		TM0_ACLK4
PA_10	PWM1_SYNC		SMC0_D02		TM0_ACLK3
PA_11	PWM1_TRIP0	UART1_CTS	SMC0_D03		TM0_ACLK2
PA_12	PWM1_AH	TM0_TMR4	SMC0_D04		
PA_13	PWM1_AL	TM0_TMR5	SMC0_D05		
PA_14	PWM1_BH	TM0_TMR6	SMC0_D06		
PA_15	PWM1_BL	TM0_TMR3	SMC0_D07		

Table 9. Signal Multiplexing for Port B (120-Lead LQFP)

Signal Name	Multiplexed Function 0	Multiplexed Function 1	Multiplexed Function 2	Multiplexed Function 3	Multiplexed Function Input Tap
PB_00	PWM0_DH	TRACE_CLK	SPT0_ACLK	SMC0_D08	CNT0_ZM
PB_01	PWM0_DL	TRACE_D00	SPT0_AFS	SMC0_D09	CNT0_UD
PB_02	PWM1_DH	TRACE_D01	SPT0_AD0	SMC0_D10	CNT0_DG
PB_03	PWM1_DL	TRACE_D02	SPT0_AD1	SMC0_D11	CNT1_ZM
PB_04	PWM2_SYNC	UART0_RTS	SPT0_ATDV	SMC0_D12	CNT1_UD
PB_05	PWM2_TRIP0	UART0_CTS	TM0_TMR7	SMC0_D13	CNT1_DG
PB_06	PWM2_AH	TM0_CLK		SMC0_D14	
PB_07	PWM2_AL	TM0_TMR0		SMC0_D15	CPTMR0_IN0
PB_08	PWM2_BH	TM0_TMR1	UART1_RX	SMC0_ARDY	TM0_ACI2/ CPTMR0_IN1
PB_09	PWM2_BL	TM0_TMR2	UART1_TX	SMC0_ARE	CPTMR0_IN2
PB_10	SINC0_CLK0	SPI0_D2	CAN1_RX	SMC0_AWE	TM0_ACI1
PB_11	SINC0_D0	SPI0_D3	CAN1_TX	SMC0_AMS0	TM0_ACLK1
PB_12	SINC0_D1		UART2_RX	SMC0_AOE	TM0_ACI3
PB_13	SINC0_D2	CNT0_OUTA	SPI0_SEL2	SMC0_A01	TM0_ACLK0/ SYS_DSWAKE3
PB_14	SINC0_D3	CNT0_OUTB	SPI0_SEL3	SMC0_A02	SPI0_SS/ SYS_DSWAKE2
PB_15	CAN0_RX	SPT1_ATDV	UART1_RX	SMC0_A03	TM0_ACI4

ADSP-CM402F/CM403F/CM407F/CM408F/CM409F

Table 10. Signal Multiplexing for Port C (120-Lead LQFP)

Signal Name	Multiplexed Function 0	Multiplexed Function 1	Multiplexed Function 2	Multiplexed Function 3	Multiplexed Function Input Tap
PC_00	CAN0_TX	SPT1_BTDTV	UART1_TX	SMC0_A04	
PC_01	UART0_RX			SMC0_A05	TM0_AC15
PC_02	UART0_TX	TRACE_D03	SPI0_RDY		
PC_03	SPI0_CLK	PWM2_CH			
PC_04	SPI0_MISO	PWM2_CL			
PC_05	SPI0_MOSI	PWM2_DH			
PC_06	SPI0_SEL1	PWM2_DL			SYS_DSWAKE0
PC_07	SINC0_CLK1	UART2_TX	UART1_RTS		SYS_DSWAKE1

ADSP-CM402F/CM403F/CM407F/CM408F/CM409F

ADSP-CM407F/ADSP-CM408F 176-LEAD LQFP SIGNAL DESCRIPTIONS

The processor's pin definitions are shown [Table 11](#). The columns in this table provide the following information:

- **Signal Name:** The Signal Name column in the table includes the signal name for every pin and (where applicable) the GPIO multiplexed pin function for every pin.
- **Description:** The Description column in the table provides a verbose (descriptive) name for the signal.
- **General-Purpose Port:** The Port column in the table shows whether or not the signal is multiplexed with other signals on a general-purpose I/O port pin.
- **Pin Name:** The Pin Name column in the table identifies the name of the package pin (at power on reset) on which the signal is located (if a single function pin) or is multiplexed (if a general-purpose I/O pin).

Table 11. ADSP-CM407F/ADSP-CM408F 176-Lead LQFP Signal Descriptions

Signal Name	Description	Port	Pin Name
ADC0_VIN00	Channel 0 Single-Ended Analog Input for ADC0	Not Muxed	ADC0_VIN00
ADC0_VIN01	Channel 1 Single-Ended Analog Input for ADC0	Not Muxed	ADC0_VIN01
ADC0_VIN02	Channel 2 Single-Ended Analog Input for ADC0	Not Muxed	ADC0_VIN02
ADC0_VIN03	Channel 3 Single-Ended Analog Input for ADC0	Not Muxed	ADC0_VIN03
ADC0_VIN04	Channel 4 Single-Ended Analog Input for ADC0	Not Muxed	ADC0_VIN04
ADC0_VIN05	Channel 5 Single-Ended Analog Input for ADC0	Not Muxed	ADC0_VIN05
ADC0_VIN06	Channel 6 Single-Ended Analog Input for ADC0	Not Muxed	ADC0_VIN06
ADC0_VIN07	Channel 7 Single-Ended Analog Input for ADC0	Not Muxed	ADC0_VIN07
ADC1_VIN00	Channel 0 Single-Ended Analog Input for ADC1	Not Muxed	ADC1_VIN00
ADC1_VIN01	Channel 1 Single-Ended Analog Input for ADC1	Not Muxed	ADC1_VIN01
ADC1_VIN02	Channel 2 Single-Ended Analog Input for ADC1	Not Muxed	ADC1_VIN02
ADC1_VIN03	Channel 3 Single-Ended Analog Input for ADC1	Not Muxed	ADC1_VIN03
ADC1_VIN04	Channel 4 Single-Ended Analog Input for ADC1	Not Muxed	ADC1_VIN04
ADC1_VIN05	Channel 5 Single-Ended Analog Input for ADC1	Not Muxed	ADC1_VIN05
ADC1_VIN06	Channel 6 Single-Ended Analog Input for ADC1	Not Muxed	ADC1_VIN06
ADC1_VIN07	Channel 7 Single-Ended Analog Input for ADC1	Not Muxed	ADC1_VIN07
BYP_A0	On-chip Analog Power Regulation Bypass Filter Node for ADC0 (see recommended bypass - Figure 4 on Page 6)	Not Muxed	BYP_A0
BYP_A1	On-chip Analog Power Regulation Bypass Filter Node for ADC1 (see recommended bypass - Figure 4 on Page 6)	Not Muxed	BYP_A1
BYP_D0	On-chip Digital Power Regulation Bypass Filter Node for Analog Subsystem (see recommended bypass - Figure 4 on Page 6)	Not Muxed	BYP_D0
CAN0_RX	CAN0 Receive	B	PB_15
CAN0_TX	CAN0 Transmit	C	PC_00
CAN1_RX	CAN1 Receive	B	PB_10
CAN1_TX	CAN1 Transmit	B	PB_11
CNT0_DG	CNT0 Count Down and Gate	B	PB_02
CNT0_OUTA	CNT0 Output Divider A	B	PB_13
CNT0_OUTA	CNT0 Output Divider A	F	PF_00
CNT0_OUTB	CNT0 Output Divider B	B	PB_14
CNT0_OUTB	CNT0 Output Divider B	F	PF_01
CNT0_UD	CNT0 Count Up and Direction	B	PB_01
CNT0_ZM	CNT0 Count Zero Marker	B	PB_00
CNT1_DG	CNT1 Count Down and Gate	B	PB_05
CNT1_OUTA	CNT1 Output Divider A	E	PE_14
CNT1_OUTB	CNT1 Output Divider B	E	PE_15

ADSP-CM402F/CM403F/CM407F/CM408F/CM409F

Table 11. ADSP-CM407F/ADSP-CM408F 176-Lead LQFP Signal Descriptions (Continued)

Signal Name	Description	Port	Pin Name
CNT1_UD	CNT1 Count Up and Direction	B	PB_04
CNT1_ZM	CNT1 Count Zero Marker	B	PB_03
CNT2_DG	CNT2 Count Down and Gate	E	PE_10
CNT2_UD	CNT2 Count Up and Direction	E	PE_09
CNT2_ZM	CNT2 Count Zero Marker	E	PE_08
CNT3_DG	CNT3 Count Down and Gate	E	PE_13
CNT3_UD	CNT3 Count Up and Direction	E	PE_12
CNT3_ZM	CNT3 Count Zero Marker	E	PE_11
CPTMR0_IN0	CPTMR0 Capture Timer0 Input 0	B	PB_07
CPTMR0_IN1	CPTMR0 Capture Timer0 Input 1	B	PB_08
CPTMR0_IN2	CPTMR0 Capture Timer0 Input 2	B	PB_09
ETH0_CRS	EMAC0 Carrier Sense/RMII Receive Data Valid	E	PE_09
ETH0_MDC	EMAC0 Management Channel Clock	E	PE_11
ETH0_MDIO	EMAC0 Management Channel Serial Data	E	PE_10
ETH0_PTPAUXIN	EMAC0 PTP Auxiliary Trigger Input	E	PE_07
ETH0_PTPCLKIN	EMAC0 PTP Clock Input	E	PE_06
ETH0_PTPPPS	EMAC0 PTP Pulse-Per-Second Output	E	PE_08
ETH0_REFCLK	EMAC0 Reference Clock	E	PE_15
ETH0_RXD0	EMAC0 Receive Data 0	F	PF_00
ETH0_RXD1	EMAC0 Receive Data 1	F	PF_01
ETH0_TXD0	EMAC0 Transmit Data 0	E	PE_12
ETH0_TXD1	EMAC0 Transmit Data 1	E	PE_13
ETH0_TXEN	EMAC0 Transmit Enable	E	PE_14
GND	Digital Ground	Not Muxed	GND
GND_ANA0	Analog Ground return for VDD_ANA0 (see recommended bypass - Figure 4 on Page 6)	Not Muxed	GND_ANA0
GND_ANA1	Analog Ground return for VDD_ANA1 (see recommended bypass - Figure 4 on Page 6)	Not Muxed	GND_ANA1
GND_ANA2	Analog Ground (see recommended bypass - Figure 4 on Page 6)	Not Muxed	GND_ANA2
GND_ANA3	Analog Ground (see recommended bypass - Figure 4 on Page 6)	Not Muxed	GND_ANA3
GND_VREF0	Ground return for VREF0 (see recommended bypass filter - Figure 4 on Page 6)	Not Muxed	GND_VREF0
GND_VREF1	Ground return for VREF1 (see recommended bypass filter - Figure 4 on Page 6)	Not Muxed	GND_VREF1
JTG_TCK/SWCLK	JTAG Clock/Serial Wire Clock	Not Muxed	JTG_TCK/SWCLK
JTG_TDI	JTAG Serial Data In	Not Muxed	JTG_TDI
JTG_TDO/SWO	JTAG Serial Data Out/Serial Wire Trace Output	Not Muxed	JTG_TDO/SWO
JTG_TMS/SWDIO	JTAG Mode Select/Serial Wire Debug Data I/O	Not Muxed	JTG_TMS/SWDIO
JTG_TRST	JTAG Reset	Not Muxed	JTG_TRST
PA_00-PA_15	Port A Positions 0 – 15	A	PA_00 – PA_15
PB_00-PB_15	Port B Positions 0 – 15	B	PB_00 – PB_15
PC_00-PC_15	Port C Positions 0 – 15	C	PC_00 – PC_15
PD_00-PD_15	Port D Positions 0 – 15	D	PD_00 – PD_15
PE_00-PE_15	Port E Positions 0 – 15	E	PE_00 – PE_15
PF_00-PF_10	Port F Positions 0 – 10	F	PF_00 – PF_10
PWM0_AH	PWM0 Channel A High Side	A	PA_02
PWM0_AL	PWM0 Channel A Low Side	A	PA_03

ADSP-CM402F/CM403F/CM407F/CM408F/CM409F

Table 11. ADSP-CM407F/ADSP-CM408F 176-Lead LQFP Signal Descriptions (Continued)

Signal Name	Description	Port	Pin Name
PWM0_BH	PWM0 Channel B High Side	A	PA_04
PWM0_BL	PWM0 Channel B Low Side	A	PA_05
PWM0_CH	PWM0 Channel C High Side	A	PA_06
PWM0_CL	PWM0 Channel C Low Side	A	PA_07
PWM0_DH	PWM0 Channel D High Side	B	PB_00
PWM0_DL	PWM0 Channel D Low Side	B	PB_01
PWM0_SYNC	PWM0 Sync	A	PA_00
$\overline{\text{PWM0_TRIP0}}$	PWM0 Trip Input 0	A	PA_01
PWM1_AH	PWM1 Channel A High Side	A	PA_12
PWM1_AL	PWM1 Channel A Low Side	A	PA_13
PWM1_BH	PWM1 Channel B High Side	A	PA_14
PWM1_BL	PWM1 Channel B Low Side	A	PA_15
PWM1_CH	PWM1 Channel C High Side	A	PA_08
PWM1_CL	PWM1 Channel C Low Side	A	PA_09
PWM1_DH	PWM1 Channel D High Side	B	PB_02
PWM1_DL	PWM1 Channel D Low Side	B	PB_03
PWM1_SYNC	PWM1 Sync	A	PA_10
$\overline{\text{PWM1_TRIP0}}$	PWM1 Trip Input 0	A	PA_11
PWM2_AH	PWM2 Channel A High Side	B	PB_06
PWM2_AL	PWM2 Channel A Low Side	B	PB_07
PWM2_BH	PWM2 Channel B High Side	B	PB_08
PWM2_BL	PWM2 Channel B Low Side	B	PB_09
PWM2_CH	PWM2 Channel C High Side	C	PC_03
PWM2_CL	PWM2 Channel C Low Side	C	PC_04
PWM2_DH	PWM2 Channel D High Side	C	PC_05
PWM2_DL	PWM2 Channel D Low Side	C	PC_06
PWM2_SYNC	PWM2 Sync	B	PB_04
$\overline{\text{PWM2_TRIP0}}$	PWM2 Trip Input 0	B	PB_05
REFCAP	Output of BandGap Generator Filter Node (see recommended bypass filter - Figure 4 on Page 6)	Not Muxed	REFCAP
SINC0_CLK0	SINC0 Clock 0	B	PB_10
SINC0_CLK1	SINC0 Clock 1	C	PC_07
SINC0_D0	SINC0 Data 0	B	PB_11
SINC0_D1	SINC0 Data 1	B	PB_12
SINC0_D2	SINC0 Data 2	B	PB_13
SINC0_D3	SINC0 Data 3	B	PB_14
SMC0_A01	SMC0 Address 1	B	PB_13
SMC0_A01	SMC0 Address 1	F	PF_05
SMC0_A02	SMC0 Address 2	B	PB_14
SMC0_A02	SMC0 Address 2	F	PF_06
SMC0_A03	SMC0 Address 3	B	PB_15
SMC0_A03	SMC0 Address 3	F	PF_07
SMC0_A04	SMC0 Address 4	C	PC_00
SMC0_A04	SMC0 Address 4	F	PF_08
SMC0_A05	SMC0 Address 5	C	PC_01
SMC0_A05	SMC0 Address 5	F	PF_09

ADSP-CM402F/CM403F/CM407F/CM408F/CM409F

Table 11. ADSP-CM407F/ADSP-CM408F 176-Lead LQFP Signal Descriptions (Continued)

Signal Name	Description	Port	Pin Name
SMC0_A06	SMC0 Address 6	D	PD_08
SMC0_A07	SMC0 Address 7	D	PD_09
SMC0_A08	SMC0 Address 8	D	PD_10
SMC0_A09	SMC0 Address 9	D	PD_11
SMC0_A10	SMC0 Address 10	D	PD_12
SMC0_A11	SMC0 Address 11	D	PD_13
SMC0_A12	SMC0 Address 12	D	PD_14
SMC0_A13	SMC0 Address 13	D	PD_15
SMC0_A14	SMC0 Address 14	E	PE_00
SMC0_A15	SMC0 Address 15	E	PE_01
SMC0_A16	SMC0 Address 16	E	PE_02
SMC0_A17	SMC0 Address 17	E	PE_03
SMC0_A18	SMC0 Address 18	E	PE_04
SMC0_A19	SMC0 Address 19	E	PE_05
SMC0_A20	SMC0 Address 20	E	PE_06
SMC0_A21	SMC0 Address 21	E	PE_07
SMC0_A22	SMC0 Address 22	E	PE_08
SMC0_A23	SMC0 Address 23	E	PE_09
SMC0_A24	SMC0 Address 24	E	PE_11
$\overline{\text{SMC0_ABE0}}$	SMC0 Byte Enable 0	F	PF_10
$\overline{\text{SMC0_ABE1}}$	SMC0 Byte Enable 1	F	PF_02
$\overline{\text{SMC0_AMS0}}$	SMC0 Memory Select 0	B	PB_11
$\overline{\text{SMC0_AMS0}}$	SMC0 Memory Select 0	Not Muxed	$\overline{\text{SMC0_AMS0}}$
$\overline{\text{SMC0_AMST}}$	SMC0 Memory Select 1	E	PE_10
$\overline{\text{SMC0_AMS2}}$	SMC0 Memory Select 2	A	PA_07
$\overline{\text{SMC0_AMS3}}$	SMC0 Memory Select 3	C	PC_11
$\overline{\text{SMC0_AOE}}$	SMC0 Output Enable	B	PB_12
$\overline{\text{SMC0_AOE}}$	SMC0 Output Enable	F	PF_03
SMC0_ARDY	SMC0 Asynchronous Ready	B	PB_08
SMC0_ARDY	SMC0 Asynchronous Ready	F	PF_04
$\overline{\text{SMC0_ARE}}$	SMC0 Read Enable	B	PB_09
$\overline{\text{SMC0_ARE}}$	SMC0 Read Enable	Not Muxed	$\overline{\text{SMC0_ARE}}$
$\overline{\text{SMC0_AWE}}$	SMC0 Write Enable	B	PB_10
$\overline{\text{SMC0_AWE}}$	SMC0 Write Enable	Not Muxed	$\overline{\text{SMC0_AWE}}$
SMC0_D00	SMC0 Data 0	A	PA_08
SMC0_D00	SMC0 Data 0	C	PC_08
SMC0_D01	SMC0 Data 1	A	PA_09
SMC0_D01	SMC0 Data 1	C	PC_09
SMC0_D02	SMC0 Data 2	A	PA_10
SMC0_D02	SMC0 Data 2	C	PC_10
SMC0_D03	SMC0 Data 3	A	PA_11
SMC0_D03	SMC0 Data 3	C	PC_11
SMC0_D04	SMC0 Data 4	A	PA_12
SMC0_D04	SMC0 Data 4	C	PC_12
SMC0_D05	SMC0 Data 5	A	PA_13
SMC0_D05	SMC0 Data 5	C	PC_13

ADSP-CM402F/CM403F/CM407F/CM408F/CM409F

Table 11. ADSP-CM407F/ADSP-CM408F 176-Lead LQFP Signal Descriptions (Continued)

Signal Name	Description	Port	Pin Name
SMC0_D06	SMC0 Data 6	A	PA_14
SMC0_D06	SMC0 Data 6	C	PC_14
SMC0_D07	SMC0 Data 7	A	PA_15
SMC0_D07	SMC0 Data 7	C	PC_15
SMC0_D08	SMC0 Data 8	B	PB_00
SMC0_D08	SMC0 Data 8	D	PD_00
SMC0_D09	SMC0 Data 9	B	PB_01
SMC0_D09	SMC0 Data 9	D	PD_01
SMC0_D10	SMC0 Data 10	B	PB_02
SMC0_D10	SMC0 Data 10	D	PD_02
SMC0_D11	SMC0 Data 11	B	PB_03
SMC0_D11	SMC0 Data 11	D	PD_03
SMC0_D12	SMC0 Data 12	B	PB_04
SMC0_D12	SMC0 Data 12	D	PD_04
SMC0_D13	SMC0 Data 13	B	PB_05
SMC0_D13	SMC0 Data 13	D	PD_05
SMC0_D14	SMC0 Data 14	B	PB_06
SMC0_D14	SMC0 Data 14	D	PD_06
SMC0_D15	SMC0 Data 15	B	PB_07
SMC0_D15	SMC0 Data 15	D	PD_07
SPIO_CLK	SPIO Clock	C	PC_03
SPIO_D2	SPIO Data 2	B	PB_10
SPIO_D3	SPIO Data 3	B	PB_11
SPIO_MISO	SPIO Master In, Slave Out	C	PC_04
SPIO_MOSI	SPIO Master Out, Slave In	C	PC_05
SPIO_RDY	SPIO Ready	C	PC_02
$\overline{\text{SPIO_SEL1}}$	SPIO Slave Select Output 1	C	PC_06
$\overline{\text{SPIO_SEL2}}$	SPIO Slave Select Output 2	B	PB_13
$\overline{\text{SPIO_SEL3}}$	SPIO Slave Select Output 3	B	PB_14
$\overline{\text{SPIO_SS}}$	SPIO Slave Select Input	B	PB_14
SPI1_CLK	SPI1 Clock	C	PC_12
SPI1_MISO	SPI1 Master In, Slave Out	C	PC_13
SPI1_MOSI	SPI1 Master Out, Slave In	C	PC_14
$\overline{\text{SPI1_SEL1}}$	SPI1 Slave Select Output 1	C	PC_15
$\overline{\text{SPI1_SEL2}}$	SPI1 Slave Select Output 2	B	PB_06
$\overline{\text{SPI1_SEL3}}$	SPI1 Slave Select Output 3	B	PB_07
$\overline{\text{SPI1_SS}}$	SPI1 Slave Select Input	C	PC_15
SPT0_ACLK	SPORT0 Channel A Clock	B	PB_00
SPT0_ACLK	SPORT0 Channel A Clock	E	PE_00
SPT0_AD0	SPORT0 Channel A Data 0	B	PB_02
SPT0_AD0	SPORT0 Channel A Data 0	E	PE_02
SPT0_AD1	SPORT0 Channel A Data 1	B	PB_03
SPT0_AD1	SPORT0 Channel A Data 1	E	PE_03
SPT0_AFS	SPORT0 Channel A Frame Sync	B	PB_01
SPT0_AFS	SPORT0 Channel A Frame Sync	E	PE_01
SPT0_ATDV	SPORT0 Channel A Transmit Data Valid	B	PB_04

ADSP-CM402F/CM403F/CM407F/CM408F/CM409F

Table 11. ADSP-CM407F/ADSP-CM408F 176-Lead LQFP Signal Descriptions (Continued)

Signal Name	Description	Port	Pin Name
SPT0_BCLK	SPORT0 Channel B Clock	C	PC_08
SPT0_BD0	SPORT0 Channel B Data 0	C	PC_10
SPT0_BD1	SPORT0 Channel B Data 1	C	PC_11
SPT0_BFS	SPORT0 Channel B Frame Sync	C	PC_09
SPT0_BTDV	SPORT0 Channel B Transmit Data Valid	B	PB_12
SPT1_ACLK	SPORT1 Channel A Clock	A	PA_00
SPT1_AD0	SPORT1 Channel A Data 0	A	PA_02
SPT1_AD1	SPORT1 Channel A Data 1	A	PA_03
SPT1_AFS	SPORT1 Channel A Frame Sync	A	PA_01
SPT1_ATDV	SPORT1 Channel A Transmit Data Valid	B	PB_15
SPT1_BCLK	SPORT1 Channel B Clock	A	PA_04
SPT1_BD0	SPORT1 Channel B Data 0	A	PA_06
SPT1_BD1	SPORT1 Channel B Data 1	A	PA_07
SPT1_BFS	SPORT1 Channel B Frame Sync	A	PA_05
SPT1_BTDV	SPORT1 Channel B Transmit Data Valid	C	PC_00
SYS_BMODE0	Boot Mode Control 0	Not Muxed	SYS_BMODE0
SYS_BMODE1	Boot Mode Control 1	Not Muxed	SYS_BMODE1
SYS_CLKIN	Clock/Crystal Input	Not Muxed	SYS_CLKIN
SYS_CLKOUT	Processor Clock Output	Not Muxed	SYS_CLKOUT
SYS_DSWAKE0	Deep Sleep Wake-up 0	C	PC_06
SYS_DSWAKE1	Deep Sleep Wake-up 1	C	PC_07
SYS_DSWAKE2	Deep Sleep Wake-up 2	B	PB_14
SYS_DSWAKE3	Deep Sleep Wake-up 3	B	PB_13
$\overline{\text{SYS_FAULT}}$	System Fault Output	Not Muxed	$\overline{\text{SYS_FAULT}}$
$\overline{\text{SYS_HWRST}}$	Processor Hardware Reset Control	Not Muxed	$\overline{\text{SYS_HWRST}}$
$\overline{\text{SYS_NMI}}$	Nonmaskable Interrupt	Not Muxed	$\overline{\text{SYS_NMI}}$
$\overline{\text{SYS_RESOUT}}$	Reset Output	Not Muxed	$\overline{\text{SYS_RESOUT}}$
SYS_XTAL	Crystal Output	Not Muxed	SYS_XTAL
TM0_AC11	TIMER0 Alternate Capture Input 1	B	PB_10
TM0_AC11	TIMER0 Alternate Capture Input 1	D	PD_13
TM0_AC12	TIMER0 Alternate Capture Input 2	B	PB_08
TM0_AC12	TIMER0 Alternate Capture Input 2	D	PD_12
TM0_AC13	TIMER0 Alternate Capture Input 3	B	PB_12
TM0_AC13	TIMER0 Alternate Capture Input 3	D	PD_11
TM0_AC14	TIMER0 Alternate Capture Input 4	B	PB_15
TM0_AC14	TIMER0 Alternate Capture Input 4	D	PD_10
TM0_AC15	TIMER0 Alternate Capture Input 5	C	PC_01
TM0_AC15	TIMER0 Alternate Capture Input 5	D	PD_09
TM0_ACLK0	TIMER0 Alternate Clock 0	B	PB_13
TM0_ACLK1	TIMER0 Alternate Clock 1	B	PB_11
TM0_ACLK2	TIMER0 Alternate Clock 2	A	PA_11
TM0_ACLK3	TIMER0 Alternate Clock 3	A	PA_10
TM0_ACLK4	TIMER0 Alternate Clock 4	A	PA_09
TM0_ACLK5	TIMER0 Alternate Clock 5	A	PA_08
TM0_CLK	TIMER0 Clock	B	PB_06
TM0_CLK	TIMER0 Clock	D	PD_08

ADSP-CM402F/CM403F/CM407F/CM408F/CM409F

Table 11. ADSP-CM407F/ADSP-CM408F 176-Lead LQFP Signal Descriptions (Continued)

Signal Name	Description	Port	Pin Name
TM0_TMR0	TIMER0 Timer 0	B	PB_07
TM0_TMR0	TIMER0 Timer 0	D	PD_00
TM0_TMR1	TIMER0 Timer 1	B	PB_08
TM0_TMR1	TIMER0 Timer 1	D	PD_01
TM0_TMR2	TIMER0 Timer 2	B	PB_09
TM0_TMR2	TIMER0 Timer 2	D	PD_02
TM0_TMR3	TIMER0 Timer 3	A	PA_15
TM0_TMR3	TIMER0 Timer 3	D	PD_03
TM0_TMR4	TIMER0 Timer 4	A	PA_12
TM0_TMR4	TIMER0 Timer 4	D	PD_04
TM0_TMR5	TIMER0 Timer 5	A	PA_13
TM0_TMR5	TIMER0 Timer 5	D	PD_05
TM0_TMR6	TIMER0 Timer 6	A	PA_14
TM0_TMR6	TIMER0 Timer 6	D	PD_06
TM0_TMR7	TIMER0 Timer 7	B	PB_05
TM0_TMR7	TIMER0 Timer 7	D	PD_07
TRACE_CLK	Embedded Trace Module Clock	B	PB_00
TRACE_D00	Embedded Trace Module Data 0	B	PB_01
TRACE_D01	Embedded Trace Module Data 1	B	PB_02
TRACE_D02	Embedded Trace Module Data 2	B	PB_03
TRACE_D03	Embedded Trace Module Data 3	C	PC_02
TRACE_D03	Embedded Trace Module Data 3	F	PF_02
TWI0_SCL	TWI0 Serial Clock	Not Muxed	TWI0_SCL
TWI0_SDA	TWI0 Serial Data	Not Muxed	TWI0_SDA
<u>UART0_CTS</u>	UART0 Clear to Send	B	PB_05
<u>UART0_RTS</u>	UART0 Request to Send	B	PB_04
<u>UART0_RX</u>	UART0 Receive	C	PC_01
<u>UART0_TX</u>	UART0 Transmit	C	PC_02
<u>UART1_CTS</u>	UART1 Clear to Send	A	PA_11
<u>UART1_RTS</u>	UART1 Request to Send	C	PC_07
<u>UART1_RX</u>	UART1 Receive	B	PB_08
<u>UART1_RX</u>	UART1 Receive	B	PB_15
<u>UART1_TX</u>	UART1 Transmit	B	PB_09
<u>UART1_TX</u>	UART1 Transmit	C	PC_00
<u>UART2_RX</u>	UART2 Receive	B	PB_12
<u>UART2_TX</u>	UART2 Transmit	C	PC_07
USB0_DM	USB0 Data -	Not Muxed	USB0_DM
USB0_DP	USB0 Data +	Not Muxed	USB0_DP
USB0_ID	USB0 OTG ID	Not Muxed	USB0_ID
USB0_VBC	USB0 VBUS Control	F	PF_02
USB0_VBUS	USB0 Bus Voltage	Not Muxed	USB0_VBUS
VDD_ANA0	Analog Voltage Domain (see recommended bypass - Figure 4 on Page 6)	Not Muxed	VDD_ANA0
VDD_ANA1	Analog Voltage Domain (see recommended bypass - Figure 4 on Page 6)	Not Muxed	VDD_ANA1
VDD_EXT	External Voltage Domain	Not Muxed	VDD_EXT
VDD_INT	Internal Voltage Domain	Not Muxed	VDD_INT

ADSP-CM402F/CM403F/CM407F/CM408F/CM409F

Table 11. ADSP-CM407F/ADSP-CM408F 176-Lead LQFP Signal Descriptions (Continued)

Signal Name	Description	Port	Pin Name
VDD_VREG	VREG Supply Voltage	Not Muxed	VDD_VREG
VREF0	Voltage Reference for ADC0. Default configuration is Output (see recommended bypass - Figure 4 on Page 6)	Not Muxed	VREF0
VREF1	Voltage Reference for ADC1. Default configuration is Output (see recommended bypass - Figure 4 on Page 6)	Not Muxed	VREF1
VREG_BASE	Voltage Regulator Base Node	Not Muxed	VREG_BASE

ADSP-CM402F/CM403F/CM407F/CM408F/CM409F

ADSP-CM407F/ADSP-CM408F GPIO MULTIPLEXING FOR 176-LEAD LQFP

Table 12 through Table 17 identify the pin functions that are multiplexed on the general-purpose I/O pins of the 176-lead LQFP package.

Table 12. Signal Multiplexing for Port A (176-Lead LQFP)

Signal Name	Multiplexed Function 0	Multiplexed Function 1	Multiplexed Function 2	Multiplexed Function 3	Multiplexed Function Input Tap
PA_00	PWM0_SYNC		SPT1_ACLK		
PA_01	PWM0_TRIP0		SPT1_AFS		
PA_02	PWM0_AH		SPT1_AD0		
PA_03	PWM0_AL		SPT1_AD1		
PA_04	PWM0_BH		SPT1_BCLK		
PA_05	PWM0_BL		SPT1_BFS		
PA_06	PWM0_CH		SPT1_BD0		
PA_07	PWM0_CL	SMC0_AMS2	SPT1_BD1		
PA_08	PWM1_CH		SMC0_D00		TM0_ACLK5
PA_09	PWM1_CL		SMC0_D01		TM0_ACLK4
PA_10	PWM1_SYNC		SMC0_D02		TM0_ACLK3
PA_11	PWM1_TRIP0	UART1_CTS	SMC0_D03		TM0_ACLK2
PA_12	PWM1_AH	TM0_TMR4	SMC0_D04		
PA_13	PWM1_AL	TM0_TMR5	SMC0_D05		
PA_14	PWM1_BH	TM0_TMR6	SMC0_D06		
PA_15	PWM1_BL	TM0_TMR3	SMC0_D07		

Table 13. Signal Multiplexing for Port B (176-Lead LQFP)

Signal Name	Multiplexed Function 0	Multiplexed Function 1	Multiplexed Function 2	Multiplexed Function 3	Multiplexed Function Input Tap
PB_00	PWM0_DH	TRACE_CLK	SPT0_ACLK	SMC0_D08	CNT0_ZM
PB_01	PWM0_DL	TRACE_D00	SPT0_AFS	SMC0_D09	CNT0_UD
PB_02	PWM1_DH	TRACE_D01	SPT0_AD0	SMC0_D10	CNT0_DG
PB_03	PWM1_DL	TRACE_D02	SPT0_AD1	SMC0_D11	CNT1_ZM
PB_04	PWM2_SYNC	UART0_RTS	SPT0_ATDV	SMC0_D12	CNT1_UD
PB_05	PWM2_TRIP0	UART0_CTS	TM0_TMR7	SMC0_D13	CNT1_DG
PB_06	PWM2_AH	TM0_CLK	SPI1_SEL2	SMC0_D14	
PB_07	PWM2_AL	TM0_TMR0	SPI1_SEL3	SMC0_D15	CPTMR0_IN0
PB_08	PWM2_BH	TM0_TMR1	UART1_RX	SMC0_ARDY	TM0_ACI2/ CPTMR0_IN1
PB_09	PWM2_BL	TM0_TMR2	UART1_TX	SMC0_ARE	CPTMR0_IN2
PB_10	SINC0_CLK0	SPI0_D2	CAN1_RX	SMC0_AWE	TM0_ACI1
PB_11	SINC0_D0	SPI0_D3	CAN1_TX	SMC0_AMS0	TM0_ACLK1
PB_12	SINC0_D1	SPT0_BTDV	UART2_RX	SMC0_AOE	TM0_ACI3
PB_13	SINC0_D2	CNT0_OUTA	SPI0_SEL2	SMC0_A01	TM0_ACLK0/ SYS_DSWAKE3
PB_14	SINC0_D3	CNT0_OUTB	SPI0_SEL3	SMC0_A02	SPI0_SS/ SYS_DSWAKE2
PB_15	CAN0_RX	SPT1_ATDV	UART1_RX	SMC0_A03	TM0_ACI4

ADSP-CM402F/CM403F/CM407F/CM408F/CM409F

Table 14. Signal Multiplexing for Port C (176-Lead LQFP)

Signal Name	Multiplexed Function 0	Multiplexed Function 1	Multiplexed Function 2	Multiplexed Function 3	Multiplexed Function Input Tap
PC_00	CAN0_TX	SPT1_BTDTV	UART1_TX	SMC0_A04	
PC_01	UART0_RX			SMC0_A05	TM0_AC15
PC_02	UART0_TX	TRACE_D03	SPI0_RDY		
PC_03	SPI0_CLK	PWM2_CH			
PC_04	SPI0_MISO	PWM2_CL			
PC_05	SPI0_MOSI	PWM2_DH			
PC_06	SPI0_SEL1	PWM2_DL			SYS_DSWARE0
PC_07	SINC0_CLK1	UART2_TX	UART1_RTS		SYS_DSWARE1
PC_08		SPT0_BCLK	SMC0_D00		
PC_09		SPT0_BFS	SMC0_D01		
PC_10		SPT0_BD0	SMC0_D02		
PC_11	SMC0_AMS3	SPT0_BD1	SMC0_D03		
PC_12		SPI1_CLK	SMC0_D04		
PC_13		SPI1_MISO	SMC0_D05		
PC_14		SPI1_MOSI	SMC0_D06		
PC_15		SPI1_SEL1	SMC0_D07		SPI1_SS

Table 15. Signal Multiplexing for Port D (176-Lead LQFP)

Signal Name	Multiplexed Function 0	Multiplexed Function 1	Multiplexed Function 2	Multiplexed Function 3	Multiplexed Function Input Tap
PD_00			SMC0_D08	TM0_TMR0	
PD_01			SMC0_D09	TM0_TMR1	
PD_02			SMC0_D10	TM0_TMR2	
PD_03			SMC0_D11	TM0_TMR3	
PD_04			SMC0_D12	TM0_TMR4	
PD_05			SMC0_D13	TM0_TMR5	
PD_06			SMC0_D14	TM0_TMR6	
PD_07			SMC0_D15	TM0_TMR7	
PD_08			SMC0_A06	TM0_CLK	
PD_09			SMC0_A07	TM0_AC15	
PD_10			SMC0_A08	TM0_AC14	
PD_11			SMC0_A09	TM0_AC13	
PD_12			SMC0_A10	TM0_AC12	
PD_13			SMC0_A11	TM0_AC11	
PD_14			SMC0_A12		
PD_15			SMC0_A13		

ADSP-CM402F/CM403F/CM407F/CM408F/CM409F

Table 16. Signal Multiplexing for Port E (176-Lead LQFP)

Signal Name	Multiplexed Function 0	Multiplexed Function 1	Multiplexed Function 2	Multiplexed Function 3	Multiplexed Function Input Tap
PE_00			SMC0_A14	SPT0_ACLK	
PE_01			SMC0_A15	SPT0_AFS	
PE_02			SMC0_A16	SPT0_AD0	
PE_03			SMC0_A17	SPT0_AD1	
PE_04			SMC0_A18		
PE_05			SMC0_A19		
PE_06		ETH0_PTPCLKIN	SMC0_A20		
PE_07		ETH0_PTPAUXIN	SMC0_A21		
PE_08		ETH0_PTPPPS	SMC0_A22		CNT2_ZM
PE_09		ETH0_CRS	SMC0_A23		CNT2_UD
PE_10		ETH0_MDIO	SMC0_AMS1		CNT2_DG
PE_11	ETH0_MDC		SMC0_A24		CNT3_ZM
PE_12	ETH0_TXD0				CNT3_UD
PE_13	ETH0_TXD1				CNT3_DG
PE_14	ETH0_TXEN	CNT1_OUTA			
PE_15	ETH0_REFCLK	CNT1_OUTB			

Table 17. Signal Multiplexing for Port F (176-Lead LQFP)

Signal Name	Multiplexed Function 0	Multiplexed Function 1	Multiplexed Function 2	Multiplexed Function 3	Multiplexed Function Input Tap
PF_00	ETH0_RXD0	CNT0_OUTA			
PF_01	ETH0_RXD1	CNT0_OUTB			
PF_02	USB0_VBC	TRACE_D03	SMC0_ABE1		
PF_03			SMC0_AOE		
PF_04			SMC0_ARDY		
PF_05			SMC0_A01		
PF_06			SMC0_A02		
PF_07			SMC0_A03		
PF_08			SMC0_A04		
PF_09			SMC0_A05		
PF_10			SMC0_ABE0		

ADSP-CM402F/CM403F/CM407F/CM408F/CM409F

ADSP-CM409F 212-BALL BGA SIGNAL DESCRIPTIONS

The processor's pin definitions are shown in [Table 18](#). The columns in this table provide the following information:

- **Signal Name:** The Signal Name column in the table includes the signal name for every pin and (where applicable) the GPIO multiplexed pin function for every pin.
- **Description:** The Description column in the table provides a verbose (descriptive) name for the signal.
- **General-Purpose Port:** The Port column in the table shows whether or not the signal is multiplexed with other signals on a general-purpose I/O port pin.
- **Pin Name:** The Pin Name column in the table identifies the name of the package pin (at power on reset) on which the signal is located (if a single function pin) or is multiplexed (if a general-purpose I/O pin).

Table 18. ADSP-CM409F 212-Ball BGA Signal Descriptions

Signal Name	Description	Port	Pin Name
ADC0_VIN00	Channel 0 Single-Ended Analog Input for ADC0	Not Muxed	ADC0_VIN00
ADC0_VIN01	Channel 1 Single-Ended Analog Input for ADC0	Not Muxed	ADC0_VIN01
ADC0_VIN02	Channel 2 Single-Ended Analog Input for ADC0	Not Muxed	ADC0_VIN02
ADC0_VIN03	Channel 3 Single-Ended Analog Input for ADC0	Not Muxed	ADC0_VIN03
ADC0_VIN04	Channel 4 Single-Ended Analog Input for ADC0	Not Muxed	ADC0_VIN04
ADC0_VIN05	Channel 5 Single-Ended Analog Input for ADC0	Not Muxed	ADC0_VIN05
ADC0_VIN06	Channel 6 Single-Ended Analog Input for ADC0	Not Muxed	ADC0_VIN06
ADC0_VIN07	Channel 7 Single-Ended Analog Input for ADC0	Not Muxed	ADC0_VIN07
ADC0_VIN08	Channel 8 Single-Ended Analog Input for ADC0	Not Muxed	ADC0_VIN08
ADC0_VIN09	Channel 9 Single-Ended Analog Input for ADC0	Not Muxed	ADC0_VIN09
ADC0_VIN10	Channel 10 Single-Ended Analog Input for ADC0	Not Muxed	ADC0_VIN10
ADC0_VIN11	Channel 11 Single-Ended Analog Input for ADC0	Not Muxed	ADC0_VIN11
ADC1_VIN00	Channel 0 Single-Ended Analog Input for ADC1	Not Muxed	ADC1_VIN00
ADC1_VIN01	Channel 1 Single-Ended Analog Input for ADC1	Not Muxed	ADC1_VIN01
ADC1_VIN02	Channel 2 Single-Ended Analog Input for ADC1	Not Muxed	ADC1_VIN02
ADC1_VIN03	Channel 3 Single-Ended Analog Input for ADC1	Not Muxed	ADC1_VIN03
ADC1_VIN04	Channel 4 Single-Ended Analog Input for ADC1	Not Muxed	ADC1_VIN04
ADC1_VIN05	Channel 5 Single-Ended Analog Input for ADC1	Not Muxed	ADC1_VIN05
ADC1_VIN06	Channel 6 Single-Ended Analog Input for ADC1	Not Muxed	ADC1_VIN06
ADC1_VIN07	Channel 7 Single-Ended Analog Input for ADC1	Not Muxed	ADC1_VIN07
ADC1_VIN08	Channel 8 Single-Ended Analog Input for ADC1	Not Muxed	ADC1_VIN08
ADC1_VIN09	Channel 9 Single-Ended Analog Input for ADC1	Not Muxed	ADC1_VIN09
ADC1_VIN10	Channel 10 Single-Ended Analog Input for ADC1	Not Muxed	ADC1_VIN10
ADC1_VIN11	Channel 11 Single-Ended Analog Input for ADC1	Not Muxed	ADC1_VIN11
BYP_A0	On-chip Analog Power Regulation Bypass Filter Node for ADC0 (see recommended bypass - Figure 4 on Page 6)	Not Muxed	BYP_A0
BYP_A1	On-chip Analog Power Regulation Bypass Filter Node for ADC1 (see recommended bypass - Figure 4 on Page 6)	Not Muxed	BYP_A1
BYP_D0	On-chip Digital Power Regulation Bypass Filter Node for Analog Subsystem (see recommended bypass - Figure 4 on Page 6)	Not Muxed	BYP_D0
CAN0_RX	CAN0 Receive	B	PB_15
CAN0_TX	CAN0 Transmit	C	PC_00
CAN1_RX	CAN1 Receive	B	PB_10
CAN1_TX	CAN1 Transmit	B	PB_11
CNT0_DG	CNT0 Count Down and Gate	B	PB_02
CNT0_OUTA	CNT0 Output Divider A	B	PB_13

ADSP-CM402F/CM403F/CM407F/CM408F/CM409F

Table 18. ADSP-CM409F 212-Ball BGA Signal Descriptions (Continued)

Signal Name	Description	Port	Pin Name
CNT0_OUTA	CNT0 Output Divider A	F	PF_00
CNT0_OUTB	CNT0 Output Divider B	B	PB_14
CNT0_OUTB	CNT0 Output Divider B	F	PF_01
CNT0_UD	CNT0 Count Up and Direction	B	PB_01
CNT0_ZM	CNT0 Count Zero Marker	B	PB_00
CNT1_DG	CNT1 Count Down and Gate	B	PB_05
CNT1_OUTA	CNT1 Output Divider A	E	PE_14
CNT1_OUTB	CNT1 Output Divider B	E	PE_15
CNT1_UD	CNT1 Count Up and Direction	B	PB_04
CNT1_ZM	CNT1 Count Zero Marker	B	PB_03
CNT2_DG	CNT2 Count Down and Gate	E	PE_10
CNT2_UD	CNT2 Count Up and Direction	E	PE_09
CNT2_ZM	CNT2 Count Zero Marker	E	PE_08
CNT3_DG	CNT3 Count Down and Gate	E	PE_13
CNT3_UD	CNT3 Count Up and Direction	E	PE_12
CNT3_ZM	CNT3 Count Zero Marker	E	PE_11
CPTMR0_IN0	CPTMR0 Capture Timer0 Input 0	B	PB_07
CPTMR0_IN1	CPTMR0 Capture Timer0 Input 1	B	PB_08
CPTMR0_IN2	CPTMR0 Capture Timer0 Input 2	B	PB_09
DAC0_VOUT	Analog Voltage Output 0	Not Muxed	DAC0_VOUT
DAC1_VOUT	Analog Voltage Output 1	Not Muxed	DAC1_VOUT
ETH0_CRS	EMAC0 Carrier Sense/RMII Receive Data Valid	E	PE_09
ETH0_MDC	EMAC0 Management Channel Clock	E	PE_11
ETH0_MDIO	EMAC0 Management Channel Serial Data	E	PE_10
ETH0_PTPAUXIN	EMAC0 PTP Auxiliary Trigger Input	E	PE_07
ETH0_PTPCLKIN	EMAC0 PTP Clock Input	E	PE_06
ETH0_PTPPPS	EMAC0 PTP Pulse-Per-Second Output	E	PE_08
ETH0_REFCLK	EMAC0 Reference Clock	E	PE_15
ETH0_RXD0	EMAC0 Receive Data 0	F	PF_00
ETH0_RXD1	EMAC0 Receive Data 1	F	PF_01
ETH0_TXD0	EMAC0 Transmit Data 0	E	PE_12
ETH0_TXD1	EMAC0 Transmit Data 1	E	PE_13
ETH0_TXEN	EMAC0 Transmit Enable	E	PE_14
GND	Digital Ground	Not Muxed	GND
GND_ANA	Analog Ground returns for VDD_ANA domain	Not Muxed	GND_ANA
GND_VREF0	Ground return for VREF0 (see recommended bypass filter - Figure 4 on Page 6)	Not Muxed	GND_VREF0
GND_VREF1	Ground return for VREF1 (see recommended bypass filter - Figure 4 on Page 6)	Not Muxed	GND_VREF1
JTG_TCK/SWCLK	JTAG Clock/Serial Wire Clock	Not Muxed	JTG_TCK/SWCLK
JTG_TDI	JTAG Serial Data In	Not Muxed	JTG_TDI
JTG_TDO/SWO	JTAG Serial Data Out/Serial Wire Trace Output	Not Muxed	JTG_TDO/SWO
JTG_TMS/SWDIO	JTAG Mode Select/Serial Wire Debug Data I/O	Not Muxed	JTG_TMS/SWDIO
JTG_TRST	JTAG Reset	Not Muxed	JTG_TRST
PA_00-PA_15	Port A Positions 0 – 15	A	PA_00 – PA_15
PB_00-PB_15	Port B Positions 0 – 15	B	PB_00 – PB_15
PC_00-PC_15	Port C Positions 0 – 15	C	PC_00 – PC_15

ADSP-CM402F/CM403F/CM407F/CM408F/CM409F

Table 18. ADSP-CM409F 212-Ball BGA Signal Descriptions (Continued)

Signal Name	Description	Port	Pin Name
PD_00-PD_15	Port D Positions 0 – 15	D	PD_00 – PD_15
PE_00-PE_15	Port E Positions 0 – 15	E	PE_00 – PE_15
PF_00-PF_10	Port F Positions 0 – 15	F	PF_00 – PF_10
PWM0_AH	PWM0 Channel A High Side	A	PA_02
PWM0_AL	PWM0 Channel A Low Side	A	PA_03
PWM0_BH	PWM0 Channel B High Side	A	PA_04
PWM0_BL	PWM0 Channel B Low Side	A	PA_05
PWM0_CH	PWM0 Channel C High Side	A	PA_06
PWM0_CL	PWM0 Channel C Low Side	A	PA_07
PWM0_DH	PWM0 Channel D High Side	B	PB_00
PWM0_DL	PWM0 Channel D Low Side	B	PB_01
PWM0_SYNC	PWM0 Sync	A	PA_00
$\overline{\text{PWM0_TRIP0}}$	PWM0 Trip Input 0	A	PA_01
PWM1_AH	PWM1 Channel A High Side	A	PA_12
PWM1_AL	PWM1 Channel A Low Side	A	PA_13
PWM1_BH	PWM1 Channel B High Side	A	PA_14
PWM1_BL	PWM1 Channel B Low Side	A	PA_15
PWM1_CH	PWM1 Channel C High Side	A	PA_08
PWM1_CL	PWM1 Channel C Low Side	A	PA_09
PWM1_DH	PWM1 Channel D High Side	B	PB_02
PWM1_DL	PWM1 Channel D Low Side	B	PB_03
PWM1_SYNC	PWM1 Sync	A	PA_10
$\overline{\text{PWM1_TRIP0}}$	PWM1 Trip Input 0	A	PA_11
PWM2_AH	PWM2 Channel A High Side	B	PB_06
PWM2_AL	PWM2 Channel A Low Side	B	PB_07
PWM2_BH	PWM2 Channel B High Side	B	PB_08
PWM2_BL	PWM2 Channel B Low Side	B	PB_09
PWM2_CH	PWM2 Channel C High Side	C	PC_03
PWM2_CL	PWM2 Channel C Low Side	C	PC_04
PWM2_DH	PWM2 Channel D High Side	C	PC_05
PWM2_DL	PWM2 Channel D Low Side	C	PC_06
PWM2_SYNC	PWM2 Sync	B	PB_04
$\overline{\text{PWM2_TRIP0}}$	PWM2 Trip Input 0	B	PB_05
REFCAP	Output of BandGap Generator Filter Node (see recommended bypass filter - Figure 4 on Page 6)	Not Muxed	REFCAP
SINC0_CLK0	SINC0 Clock 0	B	PB_10
SINC0_CLK1	SINC0 Clock 1	C	PC_07
SINC0_D0	SINC0 Data 0	B	PB_11
SINC0_D1	SINC0 Data 1	B	PB_12
SINC0_D2	SINC0 Data 2	B	PB_13
SINC0_D3	SINC0 Data 3	B	PB_14
SMC0_A01	SMC0 Address 1	B	PB_13
SMC0_A01	SMC0 Address 1	F	PF_05
SMC0_A02	SMC0 Address 2	B	PB_14
SMC0_A02	SMC0 Address 2	F	PF_06
SMC0_A03	SMC0 Address 3	B	PB_15

ADSP-CM402F/CM403F/CM407F/CM408F/CM409F

Table 18. ADSP-CM409F 212-Ball BGA Signal Descriptions (Continued)

Signal Name	Description	Port	Pin Name
SMC0_A03	SMC0 Address 3	F	PF_07
SMC0_A04	SMC0 Address 4	C	PC_00
SMC0_A04	SMC0 Address 4	F	PF_08
SMC0_A05	SMC0 Address 5	C	PC_01
SMC0_A05	SMC0 Address 5	F	PF_09
SMC0_A06	SMC0 Address 6	D	PD_08
SMC0_A07	SMC0 Address 7	D	PD_09
SMC0_A08	SMC0 Address 8	D	PD_10
SMC0_A09	SMC0 Address 9	D	PD_11
SMC0_A10	SMC0 Address 10	D	PD_12
SMC0_A11	SMC0 Address 11	D	PD_13
SMC0_A12	SMC0 Address 12	D	PD_14
SMC0_A13	SMC0 Address 13	D	PD_15
SMC0_A14	SMC0 Address 14	E	PE_00
SMC0_A15	SMC0 Address 15	E	PE_01
SMC0_A16	SMC0 Address 16	E	PE_02
SMC0_A17	SMC0 Address 17	E	PE_03
SMC0_A18	SMC0 Address 18	E	PE_04
SMC0_A19	SMC0 Address 19	E	PE_05
SMC0_A20	SMC0 Address 20	E	PE_06
SMC0_A21	SMC0 Address 21	E	PE_07
SMC0_A22	SMC0 Address 22	E	PE_08
SMC0_A23	SMC0 Address 23	E	PE_09
SMC0_A24	SMC0 Address 24	E	PE_11
$\overline{\text{SMC0_ABE0}}$	SMC0 Byte Enable 0	F	PF_10
$\overline{\text{SMC0_ABE1}}$	SMC0 Byte Enable 1	F	PF_02
$\overline{\text{SMC0_AMS0}}$	SMC0 Memory Select 0	B	PB_11
$\overline{\text{SMC0_AMS0}}$	SMC0 Memory Select 0	Not Muxed	$\overline{\text{SMC0_AMS0}}$
$\overline{\text{SMC0_AMS1}}$	SMC0 Memory Select 1	E	PE_10
$\overline{\text{SMC0_AMS2}}$	SMC0 Memory Select 2	A	PA_07
$\overline{\text{SMC0_AMS3}}$	SMC0 Memory Select 3	C	PC_11
$\overline{\text{SMC0_AOE}}$	SMC0 Output Enable	B	PB_12
$\overline{\text{SMC0_AOE}}$	SMC0 Output Enable	F	PF_03
SMC0_ARDY	SMC0 Asynchronous Ready	B	PB_08
SMC0_ARDY	SMC0 Asynchronous Ready	F	PF_04
$\overline{\text{SMC0_ARE}}$	SMC0 Read Enable	B	PB_09
$\overline{\text{SMC0_ARE}}$	SMC0 Read Enable	Not Muxed	$\overline{\text{SMC0_ARE}}$
$\overline{\text{SMC0_AWE}}$	SMC0 Write Enable	B	PB_10
$\overline{\text{SMC0_AWE}}$	SMC0 Write Enable	Not Muxed	$\overline{\text{SMC0_AWE}}$
SMC0_D00	SMC0 Data 0	A	PA_08
SMC0_D00	SMC0 Data 0	C	PC_08
SMC0_D01	SMC0 Data 1	A	PA_09
SMC0_D01	SMC0 Data 1	C	PC_09
SMC0_D02	SMC0 Data 2	A	PA_10
SMC0_D02	SMC0 Data 2	C	PC_10
SMC0_D03	SMC0 Data 3	A	PA_11

ADSP-CM402F/CM403F/CM407F/CM408F/CM409F

Table 18. ADSP-CM409F 212-Ball BGA Signal Descriptions (Continued)

Signal Name	Description	Port	Pin Name
SMC0_D03	SMC0 Data 3	C	PC_11
SMC0_D04	SMC0 Data 4	A	PA_12
SMC0_D04	SMC0 Data 4	C	PC_12
SMC0_D05	SMC0 Data 5	A	PA_13
SMC0_D05	SMC0 Data 5	C	PC_13
SMC0_D06	SMC0 Data 6	A	PA_14
SMC0_D06	SMC0 Data 6	C	PC_14
SMC0_D07	SMC0 Data 7	A	PA_15
SMC0_D07	SMC0 Data 7	C	PC_15
SMC0_D08	SMC0 Data 8	B	PB_00
SMC0_D08	SMC0 Data 8	D	PD_00
SMC0_D09	SMC0 Data 9	B	PB_01
SMC0_D09	SMC0 Data 9	D	PD_01
SMC0_D10	SMC0 Data 10	B	PB_02
SMC0_D10	SMC0 Data 10	D	PD_02
SMC0_D11	SMC0 Data 11	B	PB_03
SMC0_D11	SMC0 Data 11	D	PD_03
SMC0_D12	SMC0 Data 12	B	PB_04
SMC0_D12	SMC0 Data 12	D	PD_04
SMC0_D13	SMC0 Data 13	B	PB_05
SMC0_D13	SMC0 Data 13	D	PD_05
SMC0_D14	SMC0 Data 14	B	PB_06
SMC0_D14	SMC0 Data 14	D	PD_06
SMC0_D15	SMC0 Data 15	B	PB_07
SMC0_D15	SMC0 Data 15	D	PD_07
SPIO_CLK	SPIO Clock	C	PC_03
SPIO_D2	SPIO Data 2	B	PB_10
SPIO_D3	SPIO Data 3	B	PB_11
SPIO_MISO	SPIO Master In, Slave Out	C	PC_04
SPIO_MOSI	SPIO Master Out, Slave In	C	PC_05
SPIO_RDY	SPIO Ready	C	PC_02
$\overline{\text{SPIO_SEL1}}$	SPIO Slave Select Output 1	C	PC_06
$\overline{\text{SPIO_SEL2}}$	SPIO Slave Select Output 2	B	PB_13
$\overline{\text{SPIO_SEL3}}$	SPIO Slave Select Output 3	B	PB_14
$\overline{\text{SPIO_SS}}$	SPIO Slave Select Input	B	PB_14
SPI1_CLK	SPI1 Clock	C	PC_12
SPI1_MISO	SPI1 Master In, Slave Out	C	PC_13
SPI1_MOSI	SPI1 Master Out, Slave In	C	PC_14
$\overline{\text{SPI1_SEL1}}$	SPI1 Slave Select Output 1	C	PC_15
$\overline{\text{SPI1_SEL2}}$	SPI1 Slave Select Output 2	B	PB_06
$\overline{\text{SPI1_SEL3}}$	SPI1 Slave Select Output 3	B	PB_07
$\overline{\text{SPI1_SS}}$	SPI1 Slave Select Input	C	PC_15
SPT0_ACLK	SPORT0 Channel A Clock	B	PB_00
SPT0_ACLK	SPORT0 Channel A Clock	E	PE_00
SPT0_AD0	SPORT0 Channel A Data 0	B	PB_02
SPT0_AD0	SPORT0 Channel A Data 0	E	PE_02

ADSP-CM402F/CM403F/CM407F/CM408F/CM409F

Table 18. ADSP-CM409F 212-Ball BGA Signal Descriptions (Continued)

Signal Name	Description	Port	Pin Name
SPT0_AD1	SPORT0 Channel A Data 1	B	PB_03
SPT0_AD1	SPORT0 Channel A Data 1	E	PE_03
SPT0_AFS	SPORT0 Channel A Frame Sync	B	PB_01
SPT0_AFS	SPORT0 Channel A Frame Sync	E	PE_01
SPT0_ATDV	SPORT0 Channel A Transmit Data Valid	B	PB_04
SPT0_BCLK	SPORT0 Channel B Clock	C	PC_08
SPT0_BD0	SPORT0 Channel B Data 0	C	PC_10
SPT0_BD1	SPORT0 Channel B Data 1	C	PC_11
SPT0_BFS	SPORT0 Channel B Frame Sync	C	PC_09
SPT0_BTDV	SPORT0 Channel B Transmit Data Valid	B	PB_12
SPT1_ACLK	SPORT1 Channel A Clock	A	PA_00
SPT1_AD0	SPORT1 Channel A Data 0	A	PA_02
SPT1_AD1	SPORT1 Channel A Data 1	A	PA_03
SPT1_AFS	SPORT1 Channel A Frame Sync	A	PA_01
SPT1_ATDV	SPORT1 Channel A Transmit Data Valid	B	PB_15
SPT1_BCLK	SPORT1 Channel B Clock	A	PA_04
SPT1_BD0	SPORT1 Channel B Data 0	A	PA_06
SPT1_BD1	SPORT1 Channel B Data 1	A	PA_07
SPT1_BFS	SPORT1 Channel B Frame Sync	A	PA_05
SPT1_BTDV	SPORT1 Channel B Transmit Data Valid	C	PC_00
SYS_BMODE0	Boot Mode Control 0	Not Muxed	SYS_BMODE0
SYS_BMODE1	Boot Mode Control 1	Not Muxed	SYS_BMODE1
SYS_CLKIN	Clock/Crystal Input	Not Muxed	SYS_CLKIN
SYS_CLKOUT	Processor Clock Output	Not Muxed	SYS_CLKOUT
SYS_DSWAKE0	Deep Sleep Wake-up 0	C	PC_06
SYS_DSWAKE1	Deep Sleep Wake-up 1	C	PC_07
SYS_DSWAKE2	Deep Sleep Wake-up 2	B	PB_14
SYS_DSWAKE3	Deep Sleep Wake-up 3	B	PB_13
<u>SYS_FAULT</u>	System Fault Output	Not Muxed	<u>SYS_FAULT</u>
<u>SYS_HWRST</u>	Processor Hardware Reset Control	Not Muxed	<u>SYS_HWRST</u>
<u>SYS_NMI</u>	Nonmaskable Interrupt	Not Muxed	<u>SYS_NMI</u>
<u>SYS_RESOUT</u>	Reset Output	Not Muxed	<u>SYS_RESOUT</u>
SYS_XTAL	Crystal Output	Not Muxed	SYS_XTAL
TM0_AC11	TIMER0 Alternate Capture Input 1	B	PB_10
TM0_AC11	TIMER0 Alternate Capture Input 1	D	PD_13
TM0_AC12	TIMER0 Alternate Capture Input 2	B	PB_08
TM0_AC12	TIMER0 Alternate Capture Input 2	D	PD_12
TM0_AC13	TIMER0 Alternate Capture Input 3	B	PB_12
TM0_AC13	TIMER0 Alternate Capture Input 3	D	PD_11
TM0_AC14	TIMER0 Alternate Capture Input 4	B	PB_15
TM0_AC14	TIMER0 Alternate Capture Input 4	D	PD_10
TM0_AC15	TIMER0 Alternate Capture Input 5	C	PC_01
TM0_AC15	TIMER0 Alternate Capture Input 5	D	PD_09
TM0_ACLK0	TIMER0 Alternate Clock 0	B	PB_13
TM0_ACLK1	TIMER0 Alternate Clock 1	B	PB_11
TM0_ACLK2	TIMER0 Alternate Clock 2	A	PA_11

ADSP-CM402F/CM403F/CM407F/CM408F/CM409F

Table 18. ADSP-CM409F 212-Ball BGA Signal Descriptions (Continued)

Signal Name	Description	Port	Pin Name
TM0_ACLK3	TIMER0 Alternate Clock 3	A	PA_10
TM0_ACLK4	TIMER0 Alternate Clock 4	A	PA_09
TM0_ACLK5	TIMER0 Alternate Clock 5	A	PA_08
TM0_CLK	TIMER0 Clock	B	PB_06
TM0_CLK	TIMER0 Clock	D	PD_08
TM0_TMR0	TIMER0 Timer 0	B	PB_07
TM0_TMR0	TIMER0 Timer 0	D	PD_00
TM0_TMR1	TIMER0 Timer 1	B	PB_08
TM0_TMR1	TIMER0 Timer 1	D	PD_01
TM0_TMR2	TIMER0 Timer 2	B	PB_09
TM0_TMR2	TIMER0 Timer 2	D	PD_02
TM0_TMR3	TIMER0 Timer 3	A	PA_15
TM0_TMR3	TIMER0 Timer 3	D	PD_03
TM0_TMR4	TIMER0 Timer 4	A	PA_12
TM0_TMR4	TIMER0 Timer 4	D	PD_04
TM0_TMR5	TIMER0 Timer 5	A	PA_13
TM0_TMR5	TIMER0 Timer 5	D	PD_05
TM0_TMR6	TIMER0 Timer 6	A	PA_14
TM0_TMR6	TIMER0 Timer 6	D	PD_06
TM0_TMR7	TIMER0 Timer 7	B	PB_05
TM0_TMR7	TIMER0 Timer 7	D	PD_07
TRACE_CLK	Embedded Trace Module Clock	B	PB_00
TRACE_D00	Embedded Trace Module Data 0	B	PB_01
TRACE_D01	Embedded Trace Module Data 1	B	PB_02
TRACE_D02	Embedded Trace Module Data 2	B	PB_03
TRACE_D03	Embedded Trace Module Data 3	C	PC_02
TRACE_D03	Embedded Trace Module Data 3	F	PF_02
TWI0_SCL	TWI0 Serial Clock	Not Muxed	TWI0_SCL
TWI0_SDA	TWI0 Serial Data	Not Muxed	TWI0_SDA
<u>UART0_CTS</u>	UART0 Clear to Send	B	PB_05
<u>UART0_RTS</u>	UART0 Request to Send	B	PB_04
<u>UART0_RX</u>	UART0 Receive	C	PC_01
<u>UART0_TX</u>	UART0 Transmit	C	PC_02
<u>UART1_CTS</u>	UART1 Clear to Send	A	PA_11
<u>UART1_RTS</u>	UART1 Request to Send	C	PC_07
<u>UART1_RX</u>	UART1 Receive	B	PB_08
<u>UART1_RX</u>	UART1 Receive	B	PB_15
<u>UART1_TX</u>	UART1 Transmit	B	PB_09
<u>UART1_TX</u>	UART1 Transmit	C	PC_00
<u>UART2_RX</u>	UART2 Receive	B	PB_12
<u>UART2_TX</u>	UART2 Transmit	C	PC_07
USB0_DM	USB0 Data -	Not Muxed	USB0_DM
USB0_DP	USB0 Data +	Not Muxed	USB0_DP
USB0_ID	USB0 OTG ID	Not Muxed	USB0_ID
USB0_VBC	USB0 VBUS Control	F	PF_02
USB0_VBUS	USB0 Bus Voltage	Not Muxed	USB0_VBUS

ADSP-CM402F/CM403F/CM407F/CM408F/CM409F

Table 18. ADSP-CM409F 212-Ball BGA Signal Descriptions (Continued)

Signal Name	Description	Port	Pin Name
VDD_ANA0	Analog Voltage Domain (see recommended bypass - Figure 4 on Page 6)	Not Muxed	VDD_ANA0
VDD_ANA1	Analog Voltage Domain (see recommended bypass - Figure 4 on Page 6)	Not Muxed	VDD_ANA1
VDD_EXT	External Voltage Domain	Not Muxed	VDD_EXT
VDD_INT	Internal Voltage Domain	Not Muxed	VDD_INT
VDD_VREG	VREG Supply Voltage	Not Muxed	VDD_VREG
VREF0	Voltage Reference for ADC0. Default configuration is Output (see recommended bypass - Figure 4 on Page 6)	Not Muxed	VREF0
VREF1	Voltage Reference for ADC1. Default configuration is Output (see recommended bypass - Figure 4 on Page 6)	Not Muxed	VREF1
VREG_BASE	Voltage Regulator Base Node	Not Muxed	VREG_BASE

ADSP-CM402F/CM403F/CM407F/CM408F/CM409F

ADSP-CM409F GPIO MULTIPLEXING FOR 212-BALL BGA

Table 19 through Table 24 identify the pin functions that are multiplexed on the general-purpose I/O pins of the 212-ball BGA package.

Table 19. Signal Multiplexing for Port A (212-Ball BGA)

Signal Name	Multiplexed Function 0	Multiplexed Function 1	Multiplexed Function 2	Multiplexed Function 3	Multiplexed Function Input Tap
PA_00	PWM0_SYNC		SPT1_ACLK		
PA_01	PWM0_TRIP0		SPT1_AFS		
PA_02	PWM0_AH		SPT1_AD0		
PA_03	PWM0_AL		SPT1_AD1		
PA_04	PWM0_BH		SPT1_BCLK		
PA_05	PWM0_BL		SPT1_BFS		
PA_06	PWM0_CH		SPT1_BD0		
PA_07	PWM0_CL	SMC0_AMS2	SPT1_BD1		
PA_08	PWM1_CH		SMC0_D00		TM0_ACLK5
PA_09	PWM1_CL		SMC0_D01		TM0_ACLK4
PA_10	PWM1_SYNC		SMC0_D02		TM0_ACLK3
PA_11	PWM1_TRIP0	UART1_CTS	SMC0_D03		TM0_ACLK2
PA_12	PWM1_AH	TM0_TMR4	SMC0_D04		
PA_13	PWM1_AL	TM0_TMR5	SMC0_D05		
PA_14	PWM1_BH	TM0_TMR6	SMC0_D06		
PA_15	PWM1_BL	TM0_TMR3	SMC0_D07		

Table 20. Signal Multiplexing for Port B (212-Ball BGA)

Signal Name	Multiplexed Function 0	Multiplexed Function 1	Multiplexed Function 2	Multiplexed Function 3	Multiplexed Function Input Tap
PB_00	PWM0_DH	TRACE_CLK	SPT0_ACLK	SMC0_D08	CNT0_ZM
PB_01	PWM0_DL	TRACE_D00	SPT0_AFS	SMC0_D09	CNT0_UD
PB_02	PWM1_DH	TRACE_D01	SPT0_AD0	SMC0_D10	CNT0_DG
PB_03	PWM1_DL	TRACE_D02	SPT0_AD1	SMC0_D11	CNT1_ZM
PB_04	PWM2_SYNC	UART0_RTS	SPT0_ATDV	SMC0_D12	CNT1_UD
PB_05	PWM2_TRIP0	UART0_CTS	TM0_TMR7	SMC0_D13	CNT1_DG
PB_06	PWM2_AH	TM0_CLK	SPI1_SEL2	SMC0_D14	
PB_07	PWM2_AL	TM0_TMR0	SPI1_SEL3	SMC0_D15	CPTMR0_IN0
PB_08	PWM2_BH	TM0_TMR1	UART1_RX	SMC0_ARDY	TM0_AC12/ CPTMR0_IN1
PB_09	PWM2_BL	TM0_TMR2	UART1_TX	SMC0_ARE	CPTMR0_IN2
PB_10	SINC0_CLK0	SPIO_D2	CAN1_RX	SMC0_AWE	TM0_AC11
PB_11	SINC0_D0	SPIO_D3	CAN1_TX	SMC0_AMS0	TM0_ACLK1
PB_12	SINC0_D1	SPT0_BTDTV	UART2_RX	SMC0_AOE	TM0_AC13
PB_13	SINC0_D2	CNT0_OUTA	SPIO_SEL2	SMC0_A01	TM0_ACLK0/ SYS_DSWEAKE3
PB_14	SINC0_D3	CNT0_OUTB	SPIO_SEL3	SMC0_A02	SPIO_SS/ SYS_DSWEAKE2
PB_15	CAN0_RX	SPT1_ATDV	UART1_RX	SMC0_A03	TM0_AC14

ADSP-CM402F/CM403F/CM407F/CM408F/CM409F

Table 21. Signal Multiplexing for Port C (212-Ball BGA)

Signal Name	Multiplexed Function 0	Multiplexed Function 1	Multiplexed Function 2	Multiplexed Function 3	Multiplexed Function Input Tap
PC_00	CAN0_TX	SPT1_BTDTV	UART1_TX	SMC0_A04	
PC_01	UART0_RX			SMC0_A05	TM0_AC15
PC_02	UART0_TX	TRACE_D03	SPI0_RDY		
PC_03	SPI0_CLK	PWM2_CH			
PC_04	SPI0_MISO	PWM2_CL			
PC_05	SPI0_MOSI	PWM2_DH			
PC_06	SPI0_SEL1	PWM2_DL			SYS_DSWAKE0
PC_07	SINC0_CLK1	UART2_TX	UART1_RTS		SYS_DSWAKE1
PC_08		SPT0_BCLK	SMC0_D00		
PC_09		SPT0_BFS	SMC0_D01		
PC_10		SPT0_BD0	SMC0_D02		
PC_11	SMC0_AMS3	SPT0_BD1	SMC0_D03		
PC_12		SPI1_CLK	SMC0_D04		
PC_13		SPI1_MISO	SMC0_D05		
PC_14		SPI1_MOSI	SMC0_D06		
PC_15		SPI1_SEL1	SMC0_D07		SPI1_SS

Table 22. Signal Multiplexing for Port D (212-Ball BGA)

Signal Name	Multiplexed Function 0	Multiplexed Function 1	Multiplexed Function 2	Multiplexed Function 3	Multiplexed Function Input Tap
PD_00			SMC0_D08	TM0_TMR0	
PD_01			SMC0_D09	TM0_TMR1	
PD_02			SMC0_D10	TM0_TMR2	
PD_03			SMC0_D11	TM0_TMR3	
PD_04			SMC0_D12	TM0_TMR4	
PD_05			SMC0_D13	TM0_TMR5	
PD_06			SMC0_D14	TM0_TMR6	
PD_07			SMC0_D15	TM0_TMR7	
PD_08			SMC0_A06	TM0_CLK	
PD_09			SMC0_A07	TM0_AC15	
PD_10			SMC0_A08	TM0_AC14	
PD_11			SMC0_A09	TM0_AC13	
PD_12			SMC0_A10	TM0_AC12	
PD_13			SMC0_A11	TM0_AC11	
PD_14			SMC0_A12		
PD_15			SMC0_A13		

ADSP-CM402F/CM403F/CM407F/CM408F/CM409F

Table 23. Signal Multiplexing for Port E (212-Ball BGA)

Signal Name	Multiplexed Function 0	Multiplexed Function 1	Multiplexed Function 2	Multiplexed Function 3	Multiplexed Function Input Tap
PE_00			SMC0_A14	SPT0_ACLK	
PE_01			SMC0_A15	SPT0_AFS	
PE_02			SMC0_A16	SPT0_AD0	
PE_03			SMC0_A17	SPT0_AD1	
PE_04			SMC0_A18		
PE_05			SMC0_A19		
PE_06		ETH0_PTPCLKIN	SMC0_A20		
PE_07		ETH0_PTPAUXIN	SMC0_A21		
PE_08		ETH0_PTPPPS	SMC0_A22		CNT2_ZM
PE_09		ETH0_CRS	SMC0_A23		CNT2_UD
PE_10		ETH0_MDIO	SMC0_AMS1		CNT2_DG
PE_11	ETH0_MDC		SMC0_A24		CNT3_ZM
PE_12	ETH0_TXD0				CNT3_UD
PE_13	ETH0_TXD1				CNT3_DG
PE_14	ETH0_TXEN	CNT1_OUTA			
PE_15	ETH0_REFCLK	CNT1_OUTB			

Table 24. Signal Multiplexing for Port F (212-Ball BGA)

Signal Name	Multiplexed Function 0	Multiplexed Function 1	Multiplexed Function 2	Multiplexed Function 3	Multiplexed Function Input Tap
PF_00	ETH0_RXD0	CNT0_OUTA			
PF_01	ETH0_RXD1	CNT0_OUTB			
PF_02	USB0_VBC	TRACE_D03	SMC0_ABE1		
PF_03			SMC0_AOE		
PF_04			SMC0_ARDY		
PF_05			SMC0_A01		
PF_06			SMC0_A02		
PF_07			SMC0_A03		
PF_08			SMC0_A04		
PF_09			SMC0_A05		
PF_10			SMC0_ABE0		

ADSP-CM402F/CM403F/CM407F/CM408F/CM409F

ADSP-CM40xF DESIGNER QUICK REFERENCE

Table 25 provides a quick reference summary of pin related information for circuit board design. The columns in this table provide the following information:

- **Signal Name:** The Signal Name column in the table includes the signal name for every pin and (where applicable) the GPIO multiplexed pin function for every pin.
- **Pin Type:** The Type column in the table identifies the I/O type or supply type of the pin. The abbreviations used in this column are na (none), I/O (input/output), a (analog), s (supply), and g (ground).
- **Driver Type:** The Driver Type column in the table identifies the driver type used by the pin. The driver types are defined in the output drive currents section of this data sheet.
- **Internal Termination:** The Int Term column in the table specifies the termination present when the processor is not in the reset state. The abbreviations used in this column are wk (weak keeper, weakly retains previous value driven on the pin), pu (pull-up), or pd (pull-down).
- **Reset Termination:** The Reset Term column in the table specifies the termination present when the processor is in the reset state. The abbreviations used in this column are wk (weak keeper, weakly retains previous value driven on the pin), pu (pull-up), or pd (pull-down).
- **Reset Drive:** The Reset Drive column in the table specifies the active drive on the signal when the processor is in the reset state.
- **Power Domain:** The Power Domain column in the table specifies the power supply domain in which the signal resides.
- **Description and Notes:** The Description and Notes column in the table identifies any special requirements or characteristics for the signal. If no special requirements are listed the signal may be left unconnected if it is not used. Also, for multiplexed general-purpose I/O pins, this column identifies the functions available on the pin.

Table 25. ADSP-CM40xF Designer Quick Reference

Signal Name	Type	Driver Type	Int Term	Reset Term	Reset Drive	Power Domain	Description and Notes
ADC0_VIN00	a	na	none	none	none	VDD_ANA	Desc: Channel 0 Single-Ended Analog Input for ADC0 Notes: No notes.
ADC0_VIN01	a	na	none	none	none	VDD_ANA	Desc: Channel 1 Single-Ended Analog Input for ADC0 Notes: No notes.
ADC0_VIN02	a	na	none	none	none	VDD_ANA	Desc: Channel 2 Single-Ended Analog Input for ADC0 Notes: No notes.
ADC0_VIN03	a	na	none	none	none	VDD_ANA	Desc: Channel 3 Single-Ended Analog Input for ADC0 Notes: No notes.
ADC0_VIN04	a	na	none	none	none	VDD_ANA	Desc: Channel 4 Single-Ended Analog Input for ADC0 Notes: No notes.
ADC0_VIN05	a	na	none	none	none	VDD_ANA	Desc: Channel 5 Single-Ended Analog Input for ADC0 Notes: No notes.
ADC0_VIN06	a	na	none	none	none	VDD_ANA	Desc: Channel 6 Single-Ended Analog Input for ADC0 Notes: No notes.
ADC0_VIN07	a	na	none	none	none	VDD_ANA	Desc: Channel 7 Single-Ended Analog Input for ADC0 Notes: No notes.
ADC0_VIN08	a	na	none	none	none	VDD_ANA	Desc: Channel 8 Single-Ended Analog Input for ADC0 Notes: No notes.
ADC0_VIN09	a	na	none	none	none	VDD_ANA	Desc: Channel 9 Single-Ended Analog Input for ADC0 Notes: No notes.
ADC0_VIN10	a	na	none	none	none	VDD_ANA	Desc: Channel 10 Single-Ended Analog Input for ADC0 Notes: No notes.
ADC0_VIN11	a	na	none	none	none	VDD_ANA	Desc: Channel 11 Single-Ended Analog Input for ADC0 Notes: No notes.
ADC1_VIN00	a	na	none	none	none	VDD_ANA	Desc: Channel 0 Single-Ended Analog Input for ADC1 Notes: No notes.

ADSP-CM402F/CM403F/CM407F/CM408F/CM409F

Table 25. ADSP-CM40xF Designer Quick Reference (Continued)

Signal Name	Type	Driver Type	Int Term	Reset Term	Reset Drive	Power Domain	Description and Notes
ADC1_VIN01	a	na	none	none	none	VDD_ANA	Desc: Channel 1 Single-Ended Analog Input for ADC1 Notes: No notes.
ADC1_VIN02	a	na	none	none	none	VDD_ANA	Desc: Channel 2 Single-Ended Analog Input for ADC1 Notes: No notes.
ADC1_VIN03	a	na	none	none	none	VDD_ANA	Desc: Channel 3 Single-Ended Analog Input for ADC1 Notes: No notes.
ADC1_VIN04	a	na	none	none	none	VDD_ANA	Desc: Channel 4 Single-Ended Analog Input for ADC1 Notes: No notes.
ADC1_VIN05	a	na	none	none	none	VDD_ANA	Desc: Channel 5 Single-Ended Analog Input for ADC1 Notes: No notes.
ADC1_VIN06	a	na	none	none	none	VDD_ANA	Desc: Channel 6 Single-Ended Analog Input for ADC1 Notes: No notes.
ADC1_VIN07	a	na	none	none	none	VDD_ANA	Desc: Channel 7 Single-Ended Analog Input for ADC1 Notes: No notes.
ADC1_VIN08	a	na	none	none	none	VDD_ANA	Desc: Channel 8 Single-Ended Analog Input for ADC1 Notes: No notes.
ADC1_VIN09	a	na	none	none	none	VDD_ANA	Desc: Channel 9 Single-Ended Analog Input for ADC1 Notes: No notes.
ADC1_VIN10	a	na	none	none	none	VDD_ANA	Desc: Channel 10 Single-Ended Analog Input for ADC1 Notes: No notes.
ADC1_VIN11	a	na	none	none	none	VDD_ANA	Desc: Channel 11 Single-Ended Analog Input for ADC1 Notes: No notes.
BYP_A0	a	na	none	none	H	VDD_ANA	Desc: On-chip Analog Power Regulation Bypass Filter Node for ADC0 (see recommended bypass - Figure 4 on Page 6) Notes: This pin should never be loaded with resistive or inductive load or connected to anything but the recommended capacitor.
BYP_A1	a	na	none	none	H	VDD_ANA	Desc: On-chip Analog Power Regulation Bypass Filter Node for ADC1 (see recommended bypass - Figure 4 on Page 6) Notes: This pin should never be loaded with resistive or inductive load or connected to anything but the recommended capacitor.
BYP_D0	a	na	none	none	H	VDD_EXT	Desc: On-chip Digital Power Regulation Bypass Filter Node for Analog Subsystem (see recommended bypass - Figure 4 on Page 6) Notes: This pin should never be loaded with resistive or inductive load or connected to anything but the recommended capacitor.
DAC0_VOUT	a	na	none	none	L	VDD_ANA	Desc: Analog Voltage Output 0 Notes: No notes.
DAC1_VOUT	a	na	none	none	L	VDD_ANA	Desc: Analog Voltage Output 1 Notes: No notes.
GND	g	na	none	none	none	VDD_EXT and VDD_INT	Desc: Digital Ground Notes: No notes.
GND_ANA	g	na	none	none	none	VDD_ANA	Desc: Analog Ground returns for VDD_ANA domain Notes: No notes.
GND_ANA0	g	na	none	none	none	VDD_ANA	Desc: Analog Ground return for VDD_ANA0 (see recommended bypass - Figure 4 on Page 6) Notes: No notes

ADSP-CM402F/CM403F/CM407F/CM408F/CM409F

Table 25. ADSP-CM40xF Designer Quick Reference (Continued)

Signal Name	Type	Driver Type	Int Term	Reset Term	Reset Drive	Power Domain	Description and Notes
GND_ANA1	g	na	none	none	none	VDD_ANA	Desc: Analog Ground return for VDD_ANA1 (see recommended bypass - Figure 4 on Page 6) Notes: No notes.
GND_ANA2	g	na	none	none	none	VDD_ANA	Desc: Analog Ground (see recommended bypass - Figure 4 on Page 6) Notes: No notes.
GND_ANA3	g	na	none	none	none	VDD_ANA	Desc: Analog Ground (see recommended bypass - Figure 4 on Page 6) Notes: No notes.
GND_VREF0	g	na	none	none	none	VDD_ANA	Desc: Ground return for VREF0 (see recommended bypass filter - Figure 4 on Page 6) Notes: No notes.
GND_VREF1	g	na	none	none	none	VDD_ANA	Desc: Ground return for VREF1 (see recommended bypass filter - Figure 4 on Page 6) Notes: No notes.
JTG_TCK/SWCLK	I/O	na	pd	pd	none	VDD_EXT	Desc: JTAG Clock/Serial Wire Clock Notes: No notes.
JTG_TDI	I/O	na	pu	pu	none	VDD_EXT	Desc: JTAG Serial Data In Notes: No notes.
JTG_TDO/SWO	I/O	A	none	none	none	VDD_EXT	Desc: JTAG Serial Data Out/Serial Wire Trace Output Notes: No notes.
JTG_TMS/SWDIO	I/O	A	pu	pu	none	VDD_EXT	Desc: JTAG Mode Select/Serial Wire Debug Data I/O Notes: No notes.
$\overline{\text{JTG_TRST}}$	I/O	A	pu	pu	none	VDD_EXT	Desc: JTAG Reset Notes: Requires pull-up if using TRACE functionality; otherwise pull-down should be connected.
PA_00	I/O	A	pu or none	pu	none	VDD_EXT	Desc: PA Position 0 PWM0 Sync SPORT1 Channel A Clock Notes: By default, the internal termination pull-up is active. The state of pull-ups can be configured by configuring the PORT_INEN and PADS_PCFG0 registers.
PA_01	I/O	A	pu or none	pu	none	VDD_EXT	Desc: PA Position 1 PWM0 Trip Input 0 SPORT1 Channel A Frame Sync Notes: By default, the internal termination pull-up is active. The state of pull-ups can be configured by configuring the PORT_INEN and PADS_PCFG0 registers.
PA_02	I/O	A	pu or none	pu	none	VDD_EXT	Desc: PA Position 2 PWM0 Channel A High Side SPORT1 Channel A Data 0 Notes: By default, the internal termination pull-up is active. The state of pull-ups can be configured by configuring the PORT_INEN and PADS_PCFG0 registers.
PA_03	I/O	A	pu or none	pu	none	VDD_EXT	Desc: PA Position 3 PWM0 Channel A Low Side SPORT1 Channel A Data 1 Notes: By default, the internal termination pull-up is active. The state of pull-ups can be configured by configuring the PORT_INEN and PADS_PCFG0 registers.
PA_04	I/O	A	pu or none	pu	none	VDD_EXT	Desc: PA Position 4 PWM0 Channel B High Side SPORT1 Channel B Clock Notes: By default, the internal termination pull-up is active. The state of pull-ups can be configured by configuring the PORT_INEN and PADS_PCFG0 registers.

ADSP-CM402F/CM403F/CM407F/CM408F/CM409F

Table 25. ADSP-CM40xF Designer Quick Reference (Continued)

Signal Name	Type	Driver Type	Int Term	Reset Term	Reset Drive	Power Domain	Description and Notes
PA_05	I/O	A	pu or none	pu	none	VDD_EXT	Desc: PA Position 5 PWM0 Channel B Low Side SPORT1 Channel B Frame Sync Notes: By default, the internal termination pull-up is active. The state of pull-ups can be configured by configuring the PORT_INEN and PADS_PCFG0 registers.
PA_06	I/O	A	pu or none	pu	none	VDD_EXT	Desc: PA Position 6 PWM0 Channel C High Side SPORT1 Channel B Data 0 Notes: By default, the internal termination pull-up is active. The state of pull-ups can be configured by configuring the PORT_INEN and PADS_PCFG0 registers.
PA_07	I/O	A	pu or none	pu	none	VDD_EXT	Desc: PA Position 7 PWM0 Channel C Low Side SMC0 Memory Select 2 SPORT1 Channel B Data 1 Notes: By default, the internal termination pull-up is active. The state of pull-ups can be configured by configuring the PORT_INEN and PADS_PCFG0 registers.
PA_08	I/O	A	pu or none	pu	none	VDD_EXT	Desc: PA Position 8 PWM1 Channel C High Side SMC0 Data 0 TM0 Timer5 Alternate Clock Notes: By default, the internal termination pull-up is active. The state of pull-ups can be configured by configuring the PORT_INEN and PADS_PCFG0 registers.
PA_09	I/O	A	pu or none	pu	none	VDD_EXT	Desc: PA Position 9 PWM1 Channel C Low Side SMC0 Data 1 TM0 Timer4 Alternate Clock Notes: By default, the internal termination pull-up is active. The state of pull-ups can be configured by configuring the PORT_INEN and PADS_PCFG0 registers.
PA_10	I/O	A	pu or none	pu	none	VDD_EXT	Desc: PA Position 10 PWM1 Sync SMC0 Data 2 TM0 Timer3 Alternate Clock Notes: By default, the internal termination pull-up is active. The state of pull-ups can be configured by configuring the PORT_INEN and PADS_PCFG0 registers.
PA_11	I/O	A	pu or none	pu	none	VDD_EXT	Desc: PA Position 11 PWM1 Trip Input 0 UART1 Clear to Send SMC0 Data 3 TM0 Timer2 Alternate Clock Notes: By default, the internal termination pull-up is active. The state of pull-ups can be configured by configuring the PORT_INEN and PADS_PCFG0 registers.
PA_12	I/O	A	pu or none	pu	none	VDD_EXT	Desc: PA Position 12 PWM1 Channel A High Side TM0 Timer 4 SMC0 Data 4 Notes: By default, the internal termination pull-up is active. The state of pull-ups can be configured by configuring the PORT_INEN and PADS_PCFG0 registers.
PA_13	I/O	A	pu or none	pu	none	VDD_EXT	Desc: PA Position 13 PWM1 Channel A Low Side TM0 Timer 5 SMC0 Data 5 Notes: By default, the internal termination pull-up is active. The state of pull-ups can be configured by configuring the PORT_INEN and PADS_PCFG0 registers.
PA_14	I/O	A	pu or none	pu	none	VDD_EXT	Desc: PA Position 14 PWM1 Channel B High Side TM0 Timer 6 SMC0 Data 6 Notes: By default, the internal termination pull-up is active. The state of pull-ups can be configured by configuring the PORT_INEN and PADS_PCFG0 registers.

ADSP-CM402F/CM403F/CM407F/CM408F/CM409F

Table 25. ADSP-CM40xF Designer Quick Reference (Continued)

Signal Name	Type	Driver Type	Int Term	Reset Term	Reset Drive	Power Domain	Description and Notes
PA_15	I/O	A	pu or none	pu	none	VDD_EXT	Desc: PA Position 15 PWM1 Channel B Low Side TM0 Timer 3 SMC0 Data 7 Notes: By default, the internal termination pull-up is active. The state of pull-ups can be configured by configuring the PORT_INEN and PADS_PCFG0 registers.
PB_00	I/O	A	pu or none	pu	none	VDD_EXT	Desc: PB Position 0 PWM0 Channel D High Side Embedded Trace Module Clock SPORT0 Channel A Clock SMC0 Data 8 CNT0 Count Zero Marker Notes: By default, the internal termination pull-up is active. The state of pull-ups can be configured by configuring the PORT_INEN and PADS_PCFG0 registers.
PB_01	I/O	A	pu or none	pu	none	VDD_EXT	Desc: PB Position 1 PWM0 Channel D Low Side Embedded Trace Module Data 0 SPORT0 Channel A Frame Sync SMC0 Data 9 CNT0 Count Up and Direction Notes: By default, the internal termination pull-up is active. The state of pull-ups can be configured by configuring the PORT_INEN and PADS_PCFG0 registers.
PB_02	I/O	A	pu or none	pu	none	VDD_EXT	Desc: PB Position 2 PWM1 Channel D High Side Embedded Trace Module Data 1 SPORT0 Channel A Data 0 SMC0 Data 10 CNT0 Count Down and Gate Notes: By default, the internal termination pull-up is active. The state of pull-ups can be configured by configuring the PORT_INEN and PADS_PCFG0 registers.
PB_03	I/O	A	pu or none	pu	none	VDD_EXT	Desc: PB Position 3 PWM1 Channel D Low Side Embedded Trace Module Data 2 SPORT0 Channel A Data 1 SMC0 Data 11 CNT1 Count Zero Marker Notes: By default, the internal termination pull-up is active. The state of pull-ups can be configured by configuring the PORT_INEN and PADS_PCFG0 registers.
PB_04	I/O	A	pu or none	pu	none	VDD_EXT	Desc: PB Position 4 PWM2 Sync UART0 Request to Send SPORT0 Channel A Transmit Data Valid SMC0 Data 12 CNT1 Count Up and Direction Notes: By default, the internal termination pull-up is active. The state of pull-ups can be configured by configuring the PORT_INEN and PADS_PCFG0 registers.
PB_05	I/O	A	pu or none	pu	none	VDD_EXT	Desc: PB Position 5 PWM2 Trip Input 0 UART0 Clear to Send TM0 Timer 7 SMC0 Data 13 CNT1 Count Down and Gate Notes: By default, the internal termination pull-up is active. The state of pull-ups can be configured by configuring the PORT_INEN and PADS_PCFG0 registers.
PB_06	I/O	A	pu or none	pu	none	VDD_EXT	Desc: PB Position 6 PWM2 Channel A High Side TM0 Common Clock SPI1 Slave Select Output 2 SMC0 Data 14 Notes: By default, the internal termination pull-up is active. The state of pull-ups can be configured by configuring the PORT_INEN and PADS_PCFG0 registers.
PB_07	I/O	A	pu or none	pu	none	VDD_EXT	Desc: PB Position 7 PWM2 Channel A Low Side TM0 Timer 0 SPI1 Slave Select Output 3 SMC0 Data 15 Capture Timer0 Input 0 Notes: By default, the internal termination pull-up is active. The state of pull-ups can be configured by configuring the PORT_INEN and PADS_PCFG0 registers.

ADSP-CM402F/CM403F/CM407F/CM408F/CM409F

Table 25. ADSP-CM40xF Designer Quick Reference (Continued)

Signal Name	Type	Driver Type	Int Term	Reset Term	Reset Drive	Power Domain	Description and Notes
PB_08	I/O	A	pu or none	pu	none	VDD_EXT	Desc: PB Position 8 PWM2 Channel B High Side TM0 Timer 1 UART1 Receive SMC0 Asynchronous Ready TM0 Timer2 Alternate Capture Input Capture Timer0 Input 1 Notes: By default, the internal termination pull-up is active. The state of pull-ups can be configured by configuring the PORT_INEN and PADS_PCFG0 registers.
PB_09	I/O	A	pu or none	pu	none	VDD_EXT	Desc: PB Position 9 PWM2 Channel B Low Side TM0 Timer 2 UART1 Transmit SMC0 Read Enable Capture Timer0 Input 2 Notes: By default, the internal termination pull-up is active. The state of pull-ups can be configured by configuring the PORT_INEN and PADS_PCFG0 registers.
PB_10	I/O	A	pu or none	pu	none	VDD_EXT	Desc: PB Position 10 SINC0 Clock 0 SPI0 Data 2 CAN1 Receive SMC0 Write Enable TM0 Timer1 Alternate Capture Input Notes: By default, the internal termination pull-up is active. The state of pull-ups can be configured by configuring the PORT_INEN and PADS_PCFG0 registers.
PB_11	I/O	A	pu or none	pu	none	VDD_EXT	Desc: PB Position 11 SINC0 Data 0 SPI0 Data 3 CAN1 Transmit SMC0 Memory Select 0 TM0 Timer1 Alternate Clock Notes: By default, the internal termination pull-up is active. The state of pull-ups can be configured by configuring the PORT_INEN and PADS_PCFG0 registers.
PB_12	I/O	A	pu or none	pu	none	VDD_EXT	Desc: PB Position 12 SINC0 Data 1 SPORT0 Channel B Transmit Data Valid UART2 Receive SMC0 Output Enable TM0 Timer3 Alternate Capture Input Notes: By default, the internal termination pull-up is active. The state of pull-ups can be configured by configuring the PORT_INEN and PADS_PCFG0 registers.
PB_13	I/O	A	pu or none	pu	none	VDD_EXT	Desc: PB Position 13 SINC0 Data 2 CNT0 Output Divider A SPI0 Slave Select Output 2 SMC0 Address 1 SYS0 Deep Sleep Wakeup 3 TM0 Timer0 Alternate Clock Notes: By default, the internal termination pull-up is active. The state of pull-ups can be configured by configuring the PORT_INEN and PADS_PCFG0 registers.
PB_14	I/O	A	pu or none	pu	none	VDD_EXT	Desc: PB Position 14 SINC0 Data 3 CNT0 Output Divider B SPI0 Slave Select Output 3 SMC0 Address 2 SYS0 Deep Sleep Wakeup 2 SPI0 Slave Select Input Notes: By default, the internal termination pull-up is active. The state of pull-ups can be configured by configuring the PORT_INEN and PADS_PCFG0 registers.
PB_15	I/O	A	pu or none	pu	none	VDD_EXT	Desc: PB Position 15 CAN0 Receive SPORT1 Channel A Transmit Data Valid UART1 Receive SMC0 Address 3 TM0 Timer4 Alternate Capture Input Notes: By default, the internal termination pull-up is active. The state of pull-ups can be configured by configuring the PORT_INEN and PADS_PCFG0 registers.
PC_00	I/O	A	pu or none	pu	none	VDD_EXT	Desc: PC Position 0 CAN0 Transmit SPORT1 Channel B Transmit Data Valid UART1 Transmit SMC0 Address 4 Notes: By default, the internal termination pull-up is active. The state of pull-ups can be configured by configuring the PORT_INEN and PADS_PCFG0 registers.

ADSP-CM402F/CM403F/CM407F/CM408F/CM409F

Table 25. ADSP-CM40xF Designer Quick Reference (Continued)

Signal Name	Type	Driver Type	Int Term	Reset Term	Reset Drive	Power Domain	Description and Notes
PC_01	I/O	A	pu or none	pu	none	VDD_EXT	Desc: PC Position 1 UART0 Receive SMC0 Address 5 TM0 Timer5 Alternate Capture Input Notes: By default, the internal termination pull-up is active. The state of pull-ups can be configured by configuring the PORT_INEN and PADS_PCFG0 registers.
PC_02	I/O	A	pu or none	pu	none	VDD_EXT	Desc: PC Position 2 UART0 Transmit Embedded Trace Module Data 3 SPI0 Ready Notes: By default, the internal termination pull-up is active. The state of pull-ups can be configured by configuring the PORT_INEN and PADS_PCFG0 registers.
PC_03	I/O	A	pu or none	pu	none	VDD_EXT	Desc: PC Position 3 SPI0 Clock PWM2 Channel C High Side Notes: By default, the internal termination pull-up is active. The state of pull-ups can be configured by configuring the PORT_INEN and PADS_PCFG0 registers.
PC_04	I/O	A	pu or none	pu	none	VDD_EXT	Desc: PC Position 4 SPI0 Master In, Slave Out PWM2 Channel C Low Side Notes: By default, the internal termination pull-up is active. The state of pull-ups can be configured by configuring the PORT_INEN and PADS_PCFG0 registers.
PC_05	I/O	A	pu or none	pu	none	VDD_EXT	Desc: PC Position 5 SPI0 Master Out, Slave In PWM2 Channel D High Side Notes: By default, the internal termination pull-up is active. The state of pull-ups can be configured by configuring the PORT_INEN and PADS_PCFG0 registers.
PC_06	I/O	A	pu or none	pu	none	VDD_EXT	Desc: PC Position 6 SPI0 Slave Select Output 1 PWM2 Channel D Low Side SYS0 Deep Sleep Wakeup 0 Notes: By default, the internal termination pull-up is active. The state of pull-ups can be configured by configuring the PORT_INEN and PADS_PCFG0 registers.
PC_07	I/O	A	pu or none	pu	none	VDD_EXT	Desc: PC Position 7 SINC0 Clock 1 UART2 Transmit UART1 Request to Send SYS0 Deep Sleep Wakeup 1 Notes: By default, the internal termination pull-up is active. The state of pull-ups can be configured by configuring the PORT_INEN and PADS_PCFG0 registers.
PC_08	I/O	A	pu or none	pu	none	VDD_EXT	Desc: PC Position 8 SPORT0 Channel B Clock SMC0 Data 0 Notes: By default, the internal termination pull-up is active. The state of pull-ups can be configured by configuring the PORT_INEN and PADS_PCFG0 registers.
PC_09	I/O	A	pu or none	pu	none	VDD_EXT	Desc: PC Position 9 SPORT0 Channel B Frame Sync SMC0 Data 1 Notes: By default, the internal termination pull-up is active. The state of pull-ups can be configured by configuring the PORT_INEN and PADS_PCFG0 registers.
PC_10	I/O	A	pu or none	pu	none	VDD_EXT	Desc: PC Position 10 SPORT0 Channel B Data 0 SMC0 Data 2 Notes: By default, the internal termination pull-up is active. The state of pull-ups can be configured by configuring the PORT_INEN and PADS_PCFG0 registers.
PC_11	I/O	A	pu or none	pu	none	VDD_EXT	Desc: PC Position 11 SMC0 Memory Select 3 SPT0 Channel B Data 1 SMC0 Data 3 Notes: By default, the internal termination pull-up is active. The state of pull-ups can be configured by configuring the PORT_INEN and PADS_PCFG0 registers.

ADSP-CM402F/CM403F/CM407F/CM408F/CM409F

Table 25. ADSP-CM40xF Designer Quick Reference (Continued)

Signal Name	Type	Driver Type	Int Term	Reset Term	Reset Drive	Power Domain	Description and Notes
PC_12	I/O	A	pu or none	pu	none	VDD_EXT	Desc: PC Position 12 SPI1 Clock SMC0 Data 4 Notes: By default, the internal termination pull-up is active. The state of pull-ups can be configured by configuring the PORT_INEN and PADS_PCFG0 registers.
PC_13	I/O	A	pu or none	pu	none	VDD_EXT	Desc: PC Position 13 SPI1 Master In, Slave Out SMC0 Data 5 Notes: By default, the internal termination pull-up is active. The state of pull-ups can be configured by configuring the PORT_INEN and PADS_PCFG0 registers.
PC_14	I/O	A	pu or none	pu	none	VDD_EXT	Desc: PC Position 14 SPI1 Master Out, Slave In SMC0 Data 6 Notes: By default, the internal termination pull-up is active. The state of pull-ups can be configured by configuring the PORT_INEN and PADS_PCFG0 registers.
PC_15	I/O	A	pu or none	pu	none	VDD_EXT	Desc: PC Position 15 SPI1 Slave Select Output 1 SMC0 Data 7 SPI1 Slave Select Input Notes: By default, the internal termination pull-up is active. The state of pull-ups can be configured by configuring the PORT_INEN and PADS_PCFG0 registers.
PD_00	I/O	A	pu or none	pu	none	VDD_EXT	Desc: PD Position 0 SMC0 Data 8 TM0 Timer 0 Notes: By default, the internal termination pull-up is active. The state of pull-ups can be configured by configuring the PORT_INEN and PADS_PCFG0 registers.
PD_01	I/O	A	pu or none	pu	none	VDD_EXT	Desc: PD Position 1 SMC0 Data 9 TM0 Timer 1 Notes: By default, the internal termination pull-up is active. The state of pull-ups can be configured by configuring the PORT_INEN and PADS_PCFG0 registers.
PD_02	I/O	A	pu or none	pu	none	VDD_EXT	Desc: PD Position 2 SMC0 Data 10 TM0 Timer 2 Notes: By default, the internal termination pull-up is active. The state of pull-ups can be configured by configuring the PORT_INEN and PADS_PCFG0 registers.
PD_03	I/O	A	pu or none	pu	none	VDD_EXT	Desc: PD Position 3 SMC0 Data 11 TM0 Timer 3 Notes: By default, the internal termination pull-up is active. The state of pull-ups can be configured by configuring the PORT_INEN and PADS_PCFG0 registers.
PD_04	I/O	A	pu or none	pu	none	VDD_EXT	Desc: PD Position 4 SMC0 Data 12 TM0 Timer 4 Notes: By default, the internal termination pull-up is active. The state of pull-ups can be configured by configuring the PORT_INEN and PADS_PCFG0 registers.
PD_05	I/O	A	pu or none	pu	none	VDD_EXT	Desc: PD Position 5 SMC0 Data 13 TM0 Timer 5 Notes: By default, the internal termination pull-up is active. The state of pull-ups can be configured by configuring the PORT_INEN and PADS_PCFG0 registers.
PD_06	I/O	A	pu or none	pu	none	VDD_EXT	Desc: PD Position 6 SMC0 Data 14 TM0 Timer 6 Notes: By default, the internal termination pull-up is active. The state of pull-ups can be configured by configuring the PORT_INEN and PADS_PCFG0 registers.
PD_07	I/O	A	pu or none	pu	none	VDD_EXT	Desc: PD Position 7 SMC0 Data 15 TM0 Timer 7 Notes: By default, the internal termination pull-up is active. The state of pull-ups can be configured by configuring the PORT_INEN and PADS_PCFG0 registers.

ADSP-CM402F/CM403F/CM407F/CM408F/CM409F

Table 25. ADSP-CM40xF Designer Quick Reference (Continued)

Signal Name	Type	Driver Type	Int Term	Reset Term	Reset Drive	Power Domain	Description and Notes
PD_08	I/O	A	pu or none	pu	none	VDD_EXT	Desc: PD Position 8 SMC0 Address 6 TM0 Common Clock Notes: By default, the internal termination pull-up is active. The state of pull-ups can be configured by configuring the PORT_INEN and PADS_PCFG0 registers.
PD_09	I/O	A	pu or none	pu	none	VDD_EXT	Desc: PD Position 9 SMC0 Address 7 TM0 Timer5 Alternate Capture Input Notes: By default, the internal termination pull-up is active. The state of pull-ups can be configured by configuring the PORT_INEN and PADS_PCFG0 registers.
PD_10	I/O	A	pu or none	pu	none	VDD_EXT	Desc: PD Position 10 SMC0 Address 8 TM0 Timer4 Alternate Capture Input Notes: By default, the internal termination pull-up is active. The state of pull-ups can be configured by configuring the PORT_INEN and PADS_PCFG0 registers.
PD_11	I/O	A	pu or none	pu	none	VDD_EXT	Desc: PD Position 11 SMC0 Address 9 TM0 Timer3 Alternate Capture Input Notes: By default, the internal termination pull-up is active. The state of pull-ups can be configured by configuring the PORT_INEN and PADS_PCFG0 registers.
PD_12	I/O	A	pu or none	pu	none	VDD_EXT	Desc: PD Position 12 SMC0 Address 10 TM0 Timer2 Alternate Capture Input Notes: By default, the internal termination pull-up is active. The state of pull-ups can be configured by configuring the PORT_INEN and PADS_PCFG0 registers.
PD_13	I/O	A	pu or none	pu	none	VDD_EXT	Desc: PD Position 13 SMC0 Address 11 TM0 Timer1 Alternate Capture Input Notes: By default, the internal termination pull-up is active. The state of pull-ups can be configured by configuring the PORT_INEN and PADS_PCFG0 registers.
PD_14	I/O	A	pu or none	pu	none	VDD_EXT	Desc: PD Position 14 SMC0 Address 12 Notes: By default, the internal termination pull-up is active. The state of pull-ups can be configured by configuring the PORT_INEN and PADS_PCFG0 registers.
PD_15	I/O	A	pu or none	pu	none	VDD_EXT	Desc: PD Position 15 SMC0 Address 13 Notes: By default, the internal termination pull-up is active. The state of pull-ups can be configured by configuring the PORT_INEN and PADS_PCFG0 registers.
PE_00	I/O	A	pu or none	pu	none	VDD_EXT	Desc: PE Position 0 SMC0 Address 14 SPORT0 Channel A Clock Notes: By default, the internal termination pull-up is active. The state of pull-ups can be configured by configuring the PORT_INEN and PADS_PCFG0 registers.
PE_01	I/O	A	pu or none	pu	none	VDD_EXT	Desc: PE Position 1 SMC0 Address 15 SPORT0 Channel A Frame Sync Notes: By default, the internal termination pull-up is active. The state of pull-ups can be configured by configuring the PORT_INEN and PADS_PCFG0 registers.
PE_02	I/O	A	pu or none	pu	none	VDD_EXT	Desc: PE Position 2 SMC0 Address 16 SPORT0 Channel Data 0 Notes: By default, the internal termination pull-up is active. The state of pull-ups can be configured by configuring the PORT_INEN and PADS_PCFG0 registers.

ADSP-CM402F/CM403F/CM407F/CM408F/CM409F

Table 25. ADSP-CM40xF Designer Quick Reference (Continued)

Signal Name	Type	Driver Type	Int Term	Reset Term	Reset Drive	Power Domain	Description and Notes
PE_03	I/O	A	pu or none	pu	none	VDD_EXT	Desc: PE Position 3 SMC0 Address 17 SPORT0 Channel Data 1 Notes: By default, the internal termination pull-up is active. The state of pull-ups can be configured by configuring the PORT_INEN and PADS_PCFG0 registers.
PE_04	I/O	A	pu or none	pu	none	VDD_EXT	Desc: PE Position 4 SMC0 Address 18 Notes: By default, the internal termination pull-up is active. The state of pull-ups can be configured by configuring the PORT_INEN and PADS_PCFG0 registers.
PE_05	I/O	A	pu or none	pu	none	VDD_EXT	Desc: PE Position 5 SMC0 Address 19 Notes: By default, the internal termination pull-up is active. The state of pull-ups can be configured by configuring the PORT_INEN and PADS_PCFG0 registers.
PE_06	I/O	A	pu or none	pu	none	VDD_EXT	Desc: PE Position 6 ETH0 PTP Clock Input SMC0 Address 20 Notes: By default, the internal termination pull-up is active. The state of pull-ups can be configured by configuring the PORT_INEN and PADS_PCFG0 registers.
PE_07	I/O	A	pu or none	pu	none	VDD_EXT	Desc: PE Position 7 ETH0 PTP Auxiliary Trigger Input SMC0 Address 21 Notes: By default, the internal termination pull-up is active. The state of pull-ups can be configured by configuring the PORT_INEN and PADS_PCFG0 registers.
PE_08	I/O	A	pu or none	pu	none	VDD_EXT	Desc: PE Position 8 ETH0 PTP Pulse-Per-Second Output SMC0 Address 22 CNT2 Count Zero Marker Notes: By default, the internal termination pull-up is active. The state of pull-ups can be configured by configuring the PORT_INEN and PADS_PCFG0 registers.
PE_09	I/O	A	pu or none	pu	none	VDD_EXT	Desc: PE Position 9 ETH0 Carrier Sense SMC0 Address 23 CNT2 Count Up and Direction Notes: By default, the internal termination pull-up is active. The state of pull-ups can be configured by configuring the PORT_INEN and PADS_PCFG0 registers.
PE_10	I/O	A	pu or none	pu	none	VDD_EXT	Desc: PE Position 10 ETH0 Management Channel Serial Data SMC0 Memory Select 1 CNT2 Count Down and Gate Notes: By default, the internal termination pull-up is active. The state of pull-ups can be configured by configuring the PORT_INEN and PADS_PCFG0 registers.
PE_11	I/O	A	pu or none	pu	none	VDD_EXT	Desc: PE Position 11 ETH0 Management Channel Clock SMC0 Address 24 CNT3 Count Zero Marker Notes: By default, the internal termination pull-up is active. The state of pull-ups can be configured by configuring the PORT_INEN and PADS_PCFG0 registers.
PE_12	I/O	A	pu or none	pu	none	VDD_EXT	Desc: PE Position 12 ETH0 Transmit Data 0 CNT3 Count Up and Direction Notes: By default, the internal termination pull-up is active. The state of pull-ups can be configured by configuring the PORT_INEN and PADS_PCFG0 registers.
PE_13	I/O	A	pu or none	pu	none	VDD_EXT	Desc: PE Position 13 ETH0 Transmit Data 1 CNT3 Count Down and Gate Notes: By default, the internal termination pull-up is active. The state of pull-ups can be configured by configuring the PORT_INEN and PADS_PCFG0 registers.

ADSP-CM402F/CM403F/CM407F/CM408F/CM409F

Table 25. ADSP-CM40xF Designer Quick Reference (Continued)

Signal Name	Type	Driver Type	Int Term	Reset Term	Reset Drive	Power Domain	Description and Notes
PE_14	I/O	A	pu or none	pu	none	VDD_EXT	Desc: PE Position 14 ETH0 Transmit Enable CNT1 Output Divider A Notes: By default, the internal termination pull-up is active. The state of pull-ups can be configured by configuring the PORT_INEN and PADS_PCFG0 registers.
PE_15	I/O	A	pu or none	pu	none	VDD_EXT	Desc: PE Position 15 ETH0 Reference Clock CNT1 Output Divider B Notes: By default, the internal termination pull-up is active. The state of pull-ups can be configured by configuring the PORT_INEN and PADS_PCFG0 registers.
PF_00	I/O	A	pu or none	pu	none	VDD_EXT	Desc: PF Position 0 ETH0 Receive Data 0 CNT0 Output Divider A Notes: By default, the internal termination pull-up is active. The state of pull-ups can be configured by configuring the PORT_INEN and PADS_PCFG0 registers.
PF_01	I/O	A	pu or none	pu	none	VDD_EXT	Desc: PF Position 1 ETH0 Receive Data 1 CNT0 Output Divider B Notes: By default, the internal termination pull-up is active. The state of pull-ups can be configured by configuring the PORT_INEN and PADS_PCFG0 registers.
PF_02	I/O	A	pu or none	pu	none	VDD_EXT	Desc: PF Position 2 USB0 VBUS Control Embedded Trace Module Data 3 SMC0 Byte Enable 1 Notes: By default, the internal termination pull-up is active. The state of pull-ups can be configured by configuring the PORT_INEN and PADS_PCFG0 registers.
PF_03	I/O	A	pu or none	pu	none	VDD_EXT	Desc: PF Position 3 SMC0 Output Enable Notes: By default, the internal termination pull-up is active. The state of pull-ups can be configured by configuring the PORT_INEN and PADS_PCFG0 registers.
PF_04	I/O	A	pu or none	pu	none	VDD_EXT	Desc: PF Position 4 SMC0 Asynchronous Ready Notes: By default, the internal termination pull-up is active. The state of pull-ups can be configured by configuring the PORT_INEN and PADS_PCFG0 registers.
PF_05	I/O	A	pu or none	pu	none	VDD_EXT	Desc: PF Position 5 SMC0 Address 1 Notes: By default, the internal termination pull-up is active. The state of pull-ups can be configured by configuring the PORT_INEN and PADS_PCFG0 registers.
PF_06	I/O	A	pu or none	pu	none	VDD_EXT	Desc: PF Position 6 SMC0 Address 2 Notes: By default, the internal termination pull-up is active. The state of pull-ups can be configured by configuring the PORT_INEN and PADS_PCFG0 registers.
PF_07	I/O	A	pu or none	pu	none	VDD_EXT	Desc: PF Position 7 SMC0 Address 3 Notes: By default, the internal termination pull-up is active. The state of pull-ups can be configured by configuring the PORT_INEN and PADS_PCFG0 registers.
PF_08	I/O	A	pu or none	pu	none	VDD_EXT	Desc: PF Position 8 SMC0 Address 4 Notes: By default, the internal termination pull-up is active. The state of pull-ups can be configured by configuring the PORT_INEN and PADS_PCFG0 registers.

ADSP-CM402F/CM403F/CM407F/CM408F/CM409F

Table 25. ADSP-CM40xF Designer Quick Reference (Continued)

Signal Name	Type	Driver Type	Int Term	Reset Term	Reset Drive	Power Domain	Description and Notes
PF_09	I/O	A	pu or none	pu	none	VDD_EXT	Desc: PF Position 9 SMC0 Address 5 Notes: By default, the internal termination pull-up is active. The state of pull-ups can be configured by configuring the PORT_INEN and PADS_PCFG0 registers.
PF_10	I/O	A	pu or none	pu	none	VDD_EXT	Desc: PF Position 10 SMC0 Byte Enable 0 Notes: By default, the internal termination pull-up is active. The state of pull-ups can be configured by configuring the PORT_INEN and PADS_PCFG0 registers.
REFCAP	a	na	none	none	none	VDD_ANA	Desc: Output of BandGap Generator Filter Node (see recommended bypass filter - Figure 4 on Page 6) Notes: No notes.
$\overline{\text{SMC0_AMS0}}$	I/O	A	pu	pu	none	VDD_EXT	Desc: SMC0 Memory Select 0 Notes: No notes.
$\overline{\text{SMC0_ARE}}$	I/O	A	pu	pu	none	VDD_EXT	Desc: SMC0 Read Enable Notes: No notes.
$\overline{\text{SMC0_AWE}}$	I/O	A	pu	pu	none	VDD_EXT	Desc: SMC0 Write Enable Notes: No notes.
SYS_BMODE0	I/O	na	none	none	none	VDD_EXT	Desc: Boot Mode Control 0 Notes: No notes.
SYS_BMODE1	I/O	na	none	none	none	VDD_EXT	Desc: Boot Mode Control 1 Notes: No notes.
SYS_CLKIN	I/O	na	none	none	none	VDD_EXT	Desc: Clock/Crystal Input Notes: No notes.
SYS_CLKOUT	I/O	na	pu	none	L	VDD_EXT	Desc: Processor Clock Output Notes: No notes.
$\overline{\text{SYS_FAULT}}$	I/O	A	none	none	none	VDD_EXT	Desc: System Fault Output Notes: Open drain, requires an external pull-up resistor.
$\overline{\text{SYS_HWRST}}$	I/O	na	none	none	none	VDD_EXT	Desc: Processor Hardware Reset Control Notes: No notes.
$\overline{\text{SYS_NMI}}$	I/O	A	none	none	none	VDD_EXT	Desc: Non-maskable Interrupt Notes: Requires an external pull-up resistor.
$\overline{\text{SYS_RESOUT}}$	I/O	A	pu	none	L	VDD_EXT	Desc: Reset Output Notes: No notes.
SYS_XTAL	a	na	none	none	none	VDD_EXT	Desc: Crystal Output Notes: Leave unconnected if an oscillator is used to provide SYS_CLKIN. Active during reset.
TWI0_SCL	I/O	B	none	none	none	VDD_EXT	Desc: TWI0 Serial Clock Notes: Open drain, requires external pullup resistor. Consult Version 2.1 of the I2C specification for the proper resistor value. If TWI is not used, connect to ground.
TWI0_SDA	I/O	B	none	none	none	VDD_EXT	Desc: TWI0 Serial Data Notes: en drain, requires external pullup resistor. Consult Version 2.1 of the I2C specification for the proper resistor value. If TWI is not used, connect to ground.
USB0_DM	I/O	D	none	none	none	VDD_EXT	Desc: USB0 Data - Notes: Pull low if not using USB.
USB0_DP	I/O	D	none	none	none	VDD_EXT	Desc: USB0 Data + Notes: Pull low if not using USB.

ADSP-CM402F/CM403F/CM407F/CM408F/CM409F

Table 25. ADSP-CM40xF Designer Quick Reference (Continued)

Signal Name	Type	Driver Type	Int Term	Reset Term	Reset Drive	Power Domain	Description and Notes
USB0_ID	I/O	na	none	none	none	VDD_EXT	Desc: USB0 OTG ID Notes: If USB is not used, connect to ground.
USB0_VBUS	I/O	E	none	none	none	VDD_EXT	Desc: USB0 Bus Voltage Notes: If USB is not used, pull low.
VDD_ANA0	s	na	none	none	none	na	Desc: Analog Power Supply Voltage 3.13 V to 3.47 V (see recommended bypass - Figure 4 on Page 6) Notes: No notes.
VDD_ANA1	s	na	none	none	none	na	Desc: Analog Power Supply Voltage 3.13 V to 3.47 V (see recommended bypass - Figure 4 on Page 6) Notes: No notes.
VDD_EXT	s	na	none	none	none	na	Desc: External Voltage Domain Notes: No notes.
VDD_INT	s	na	none	none	none	na	Desc: Internal Voltage Domain Notes: No notes.
VDD_VREG	s	na	none	none	none	na	Desc: VREG Supply Voltage Notes: No notes.
VREF0	a	na	none	none	none	na	Desc: Voltage Reference for ADC0. Default configuration is Output (see recommended bypass - Figure 4 on Page 6) Notes: When using internal ADC reference, this pin should never be loaded with resistive or inductive load or connected to anything but the recommended capacitor. When using external ADC reference, connect to externally generated reference voltage supply
VREF1	a	na	none	none	none	na	Desc: Voltage Reference for ADC1. Default configuration is Output (see recommended bypass - Figure 4 on Page 6) Notes: When using internal ADC reference, this pin should never be loaded with resistive or inductive load or connected to anything but the recommended capacitor. When using external ADC reference, connect to externally generated reference voltage supply
VREG_BASE	a	na	none	none	none	na	Desc: Voltage Regulator Base Node Notes: When unused, connect to GND or pull low

ADSP-CM402F/CM403F/CM407F/CM408F/CM409F

SPECIFICATIONS

For information about product specifications, contact your Analog Devices representative.

OPERATING CONDITIONS

Parameter	Test Conditions/Comments	Min	Nominal	Max	Unit	
V_{DD_INT}	Digital Internal Supply Voltage	$f_{CLK} \leq 240$ MHz	1.14	1.2	1.26	V
$V_{DD_EXT}^1$	Digital External Supply Voltage		3.13	3.3	3.47	V
$V_{DD_ANA}^1$	Analog Supply Voltage		3.13	3.3	3.47	V
V_{IH}^2	High Level Input Voltage	$V_{DD_EXT} = 3.47$ V	2.0			V
$V_{IH_CLKIN}^3$	High Level Input Voltage	$V_{DD_EXT} = 3.47$ V	2.2			V
$V_{IHTWI}^{4,5}$	High Level Input Voltage	$V_{DD_EXT} = 3.47$ V	$0.7 \times V_{VBUSTWI}$		$V_{VBUSTWI}$	V
V_{IL}^2	Low Level Input Voltage	$V_{DD_EXT} = 3.13$ V		0.8		V
$V_{ILTWI}^{4,5}$	Low Level Input Voltage	$V_{DD_EXT} = 3.13$ V		$0.3 \times V_{VBUSTWI}$		V
T_J	Junction Temperature	$T_{AMBIENT} = -40^\circ\text{C}$ to $+105^\circ\text{C}$	-40		+125	$^\circ\text{C}$

¹ Must remain powered (even if the associated function is not used).

² Parameter value applies to all input and bidirectional signals except TWI signals and USB0 signals.

³ Parameter applies to SYS_CLKIN signal.

⁴ Parameter applies to TWI_SDA and TWI_SCL.

⁵ TWI signals are pulled up to $V_{VBUSTWI}$. See Table 26.

Table 26. TWI_VSEL Selections and $V_{DD_EXT}/V_{VBUSTWI}$

TWI_DT Setting	V_{DD_EXT} Nominal	$V_{VBUSTWI}$ Min	$V_{VBUSTWI}$ Nom	$V_{VBUSTWI}$ Max	Unit
TWI000 ¹	3.30	3.13	3.30	3.47	V
TWI100	3.30	4.75	5.00	5.25	V

¹ Designs must comply with the V_{DD_EXT} and $V_{VBUSTWI}$ voltages specified for the default TWI_DT setting for correct JTAG boundary scan operation during reset.

Clock Related Operating Conditions

Table 27 describes the core clock, system clock, and peripheral clock timing requirements. The data presented in the tables applies to all speed grades found in the Ordering Guide on Page 124 except where expressly noted. Figure 10 provides a graphical representation of the various clocks and their available multiplier or divider values.

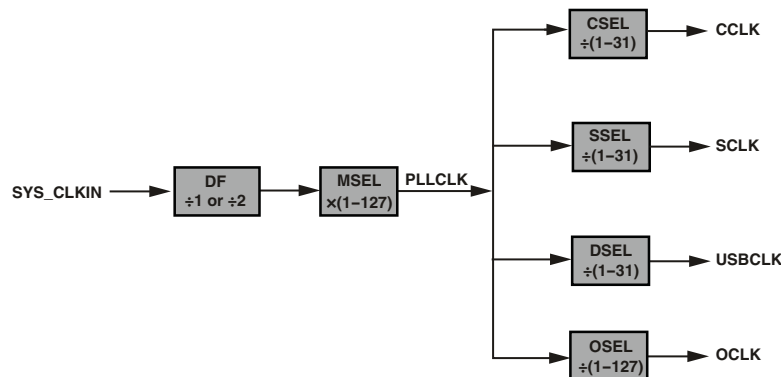

Figure 10. Clock Relationships and Divider Values

ADSP-CM402F/CM403F/CM407F/CM408F/CM409F

Table 27. Clock Related Operating Conditions

Parameter	Restriction	Min	Typ	Max	Unit
f _{PLLCLK}	PLL Clock Frequency	250		960	MHz
f _{CCLK}	Core Clock Frequency	f _{CCLK} ≥ f _{SCLK}		240	MHz
f _{SCLK}	SCLK Frequency ^{1, 2}			100	MHz
f _{USBCLK}	USBCLK Frequency ^{3, 4}	f _{SCLK} ≥ f _{USBCLK}		60	MHz
f _{OCLK}	Output Clock Frequency			50	MHz
f _{TCK}	JTG_TCK Frequency	f _{TCK} ≤ f _{SCLK} /2		50	MHz
f _{SYS_CLKOUTJ}	SYS_CLKOUT Period Jitter ^{5, 6}		±1		%
f _{ADCC_ACLK_PROG}	Programmed ADCC ADC0 (A) Clock			50	MHz
f _{ADCC_BCLK_PROG}	Programmed ADCC ADC1 (B) Clock			50	MHz
f _{DACC_ACLK_PROG}	Programmed DACC DAC0 (A) Clock			50	MHz
f _{DACC_BCLK_PROG}	Programmed DACC DAC1 (B) Clock			50	MHz
f _{SPTCLKPROG}	Programmed SPT Clock When Transmitting Data and Frame Sync			50	MHz
f _{SPTCLKPROG}	Programmed SPT Clock When Receiving Data and Frame Sync			50	MHz
f _{SPTCLKEXT}	External SPT Clock When Transmitting Data and Frame Sync ^{7, 8}	f _{SPTCLKEXT} ≤ f _{SCLK}		50	MHz
f _{SPTCLKEXT}	External SPT Clock When Receiving Data and Frame Sync ^{7, 8}	f _{SPTCLKEXT} ≤ f _{SCLK}		50	MHz
f _{SPICLKPROG}	Programmed SPI Clock When Transmitting Data ^{7, 8}			50	MHz
f _{SPICLKPROG}	Programmed SPI Clock When Receiving Data			50	MHz
f _{SPICLKEXT}	External SPI Clock When Transmitting Data ^{7, 8}	f _{SPICLKEXT} ≤ f _{SCLK}		50	MHz
f _{SPICLKEXT}	External SPI Clock When Receiving Data ^{7, 8}	f _{SPICLKEXT} ≤ f _{SCLK}		50	MHz
f _{TMRLKEXT}	External TMR Clock	f _{TMRLKEXT} ≤ f _{SCLK} /4		25	MHz
f _{SINCLKPROG}	Programmed SINC Clock	f _{SINCLKPROG} ≤ f _{SCLK} /4		20	MHz
f _{REFCLKEXT}	External Ethernet MAC Clock	f _{REFCLKEXT} ≤ f _{SCLK}		50	MHz

¹ Supporting documents may use either SCLK or SYSCLK when referring to system clock frequency.

² SCLK is the clock for the system logic. Documentation may interchangeably refer to this clock as SYSCLK, for example, for PLL configuration MMR accesses.

³ Supporting documents may use either USBCLK or DCLK when referring to USB clock frequency.

⁴ USBCLK is the clock for the USB peripheral. Documentation may interchangeably refer to this clock as DCLK, for example, for PLL configuration MMR accesses.

⁵ SYS_CLKOUT jitter is dependent on the application system design including pin switching activity, board layout, and the jitter characteristics of the SYS_CLKIN source. Due to the dependency on these factors the measured jitter may be higher or lower than this specification for each end application.

⁶ The value in the Typ field is the percentage of the SYS_CLKOUT period.

⁷ The maximum achievable frequency for any peripheral in external clock mode is dependent on being able to meet the setup and hold times in the ac timing specifications for that peripheral.

⁸ The peripheral external clock frequency must also be less than or equal to f_{SCLK} that clocks the peripheral.

ADSP-CM402F/CM403F/CM407F/CM408F/CM409F

ELECTRICAL CHARACTERISTICS

Parameter	Test Conditions/Comments	Min	Typ	Max	Unit
V_{OH}^1	High Level Output Voltage	$V_{DD_EXT} = 3.13\text{ V}, I_{OH} = -0.5\text{ mA}$			V
V_{OL}^2	Low Level Output Voltage	$V_{DD_EXT} = 3.13\text{ V}, I_{OL} = 2.0\text{ mA}$		0.4	V
I_{IH}^3	High Level Input Current	$V_{DD_EXT} = 3.47\text{ V}, V_{IN} = 3.47\text{ V}$		10	μA
I_{IL}^3	Low Level Input Current	$V_{DD_EXT} = 3.47\text{ V}, V_{IN} = 0\text{ V}$		10	μA
$I_{IH_PD}^4$	High Level Input Current With Pull-down Resistor	$V_{DD_EXT} = 3.47\text{ V}, V_{IN} = 3.47\text{ V}$		100	μA
$I_{IL_PU}^5$	Low Level Input Current With Pull-up Resistor	$V_{DD_EXT} = 3.47\text{ V}, V_{IN} = 0\text{ V}$		100	μA
$I_{IL_USB0}^6$	Low Level Input Current	$V_{DD_EXT} = 3.47\text{ V}, V_{IN} = 0\text{ V}$		200	μA
I_{OZH}^7	Three-State Leakage Current	$V_{DD_EXT} = 3.47\text{ V}, V_{IN} = 3.47\text{ V}$		10	μA
$I_{OZL_PU}^8$	Three-State Leakage Current With Pull-up Resistor	$V_{DD_EXT} = 3.47\text{ V}, V_{IN} = 0\text{ V}$		100	μA
I_{OZHTWI}^9	Three-State Leakage Current	$V_{DD_EXT} = 3.47\text{ V}, V_{IN} = 5.5\text{ V}$		10	μA
I_{OZL}^7	Three-State Leakage Current	$V_{DD_EXT} = 3.47\text{ V}, V_{IN} = 0\text{ V}$		10	μA
C_{IN}^{10}	Input Capacitance	$T_J = 25^\circ\text{C}$		4.2	pF
$C_{IN_TWI}^9$	Input Capacitance	$T_J = 25^\circ\text{C}$		8.3	pF
I_{DDINT_STATIC}	V_{DD_INT} Static Current	$f_{CCLK} = 0\text{ MHz}$ $f_{SCLK} = 0\text{ MHz}$		See Figure 11 on Page 67	
I_{DD_IDLE}	V_{DD_INT} Current in Idle	$f_{CCLK} = 200\text{ MHz}$ ASF = 0.31 (idle), $f_{SCLK} = 100\text{ MHz}$ No DMA activity $T_J = 25^\circ\text{C}$		59	mA
I_{DD_TYP}	V_{DD_INT} Current	$f_{CCLK} = 200\text{ MHz}$ ASF = 1.0 (typical), $f_{SCLK} = 100\text{ MHz}$ DMA data rate = 100 MB/s $T_J = 25^\circ\text{C}$		97	mA
I_{DD_TYP}	V_{DD_INT} Current	$f_{CCLK} = 240\text{ MHz}$ ASF = 1.0 (typical), $f_{SCLK} = 96\text{ MHz}$ DMA data rate = 100 MB/s $T_J = 25^\circ\text{C}$		104	mA
I_{DD_INT}	V_{DD_INT} Current	$f_{CCLK} > 0\text{ MHz}$ $f_{SCLK} \geq 0\text{ MHz}$		See I_{DDINT_TOT} equation	
I_{DD_EXT}	V_{DD_EXT} Current			See I_{DDEXT_TOT} equation	
I_{DD_ANA}	$V_{DD_ANA0} + V_{DD_ANA1}$ Current			60	70

¹ Applies to all output and bidirectional signals except TWI signals and USB0 signals.

² Applies to all output and bidirectional signals except USB0 signals.

³ Applies to input pins.

⁴ Applies to signal JTG_TCK.

⁵ Applies to signals JTG_TMS, JTG_TRST, and JTAG_TDI.

⁶ Applies to signals USB0_DM and USB0_VBUS.

⁷ Applies to three-statable pins.

⁸ Applies to all GPIO pins when pull-up resistors are enabled.

⁹ Applies to all TWI signals.

¹⁰ Applies to all signals except TWI signals.

ADSP-CM402F/CM403F/CM407F/CM408F/CM409F

Total Power Dissipation (PD)

Total power dissipation is the sum of power dissipation for each V_{DD} domain, shown in the following equation.

$$P_D = P_{D_INT} + P_{D_ANA} + P_{D_EXT}$$

where:

$$P_{D_INT} = V_{DD_INT} \times I_{DD_INT} - \text{Internal voltage domain power dissipation}$$

$$P_{D_ANA} = V_{DD_ANA} \times I_{DD_ANA} - \text{Analog 3.3 V voltage domain power dissipation}$$

$$P_{D_EXT} = V_{DD_EXT} \times I_{DD_EXT} - \text{Digital 3.3 V voltage domain power dissipation}$$

Total External Power Dissipation (IDD_EXT)

There are three different items that contribute to the digital 3.3 V supply power dissipation: I/O switching, flash subsystem, and analog subsystem (digital portion), shown in the following equation.

$$I_{DDEXT_TOT} = I_{DDEXT_IO} + I_{DDEXT_FLASH} + I_{DDEXT_ANA}$$

where:

$$I_{DDEXT_IO/ANA} \text{ (mA)} = \Sigma \{ V_{DD_EXT} \times C_L f / 2 \times (O \times TR) \times U \} - \text{I/O switching current}$$

The I/O switching current is the sum of the switching current for all of the enabled peripherals. For each peripheral the capacitive load of each pin in Farads (C_L), operating frequency in MHz (f), number of output pins (O), toggle ratio for each pin (TR), and peripheral utilization (U) are considered.

$$I_{DDEXT_FLASH} \text{ (mA)} = 25 \text{ mA} - \text{maximum flash subsystem current}$$

Total Processor Internal Power Dissipation (IDD_INT)

Many operating conditions affect power dissipation, including temperature, voltage, operating frequency, and processor activity. Total internal power dissipation for the processor subsystem has two components:

1. Static, including leakage current
2. Dynamic, due to transistors switching characteristics for each clock domain. Application-dependent currents, clock currents, and data transmission currents all contribute to dynamic power dissipation.

The following equation describes the internal current consumption.

$$I_{DDINT_TOT} = I_{DDINT_CCLK_DYN} + I_{DDINT_SCLK_DYN} + I_{DDINT_DMA_DR_DYN} + I_{DDINT_STATIC}$$

Static Current

I_{DDINT_STATIC} is the current present in the device with all clocks stopped. I_{DDINT_STATIC} is specified as a function of temperature (see Figure 11).

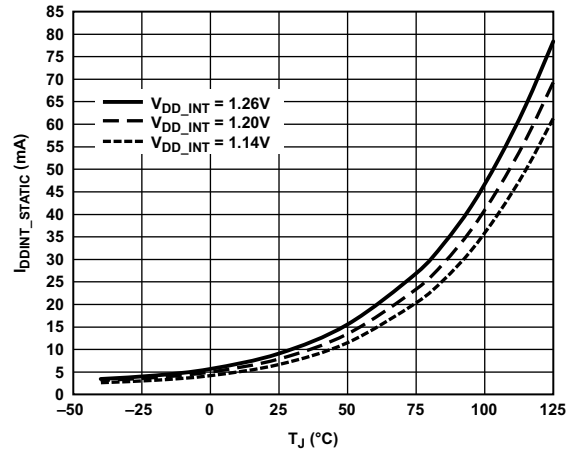

Figure 11. Static Current— I_{DDINT_STATIC} (mA)

Core Clock Application-Dependent Current

Core clock (CCLK) use is subject to an activity scaling factor (ASF) that represents application code running on the processor core and L1 memory (Table 28). The ASF is combined with the CCLK frequency to calculate this portion.

$$I_{DDINT_CCLK_DYN} \text{ (mA)} = 0.192 \times f_{CCLK} \text{ (MHz)} \times ASF \times V_{DD_INT} \text{ (V)}$$

Table 28. Activity Scaling Factors (ASF)

I_{DD_INT} Power Vector	ASF
I_{DD_PEAK}	1.85
$I_{DD_COREMARK}$ (typical)	1.0
I_{DD_IDLE}	0.31

System Clock Current

The power dissipated by the system clock domain is dependent on operating frequency and a unique scaling factor.

$$I_{DDINT_SCLK_DYN} \text{ (mA)} = 0.308 \times f_{SCLK} \text{ (MHz)} \times V_{DD_INT} \text{ (V)}$$

Data Transmission Current

The data transmission current represents the power dissipated when transmitting data. This current is expressed in terms of data rate. The calculation is performed by adding the data rate (MB/s) of each DMA and core driven access to peripherals and L2/external memory. This number is then multiplied by a coefficient. The following equation provides an estimate of all data transmission current.

$$I_{DDINT_DMA_DR_DYN} \text{ (mA)} = 0.0475 \times \text{data rate (MB/s)} \times V_{DD_INT} \text{ (V)}$$

ADSP-CM402F/CM403F/CM407F/CM408F/CM409F

ADC/DAC SPECIFICATIONS

ADC Specifications

Typical values assume $V_{DD_ANA} = 3.3\text{ V}$, $V_{REF} = 2.5\text{ V}$.

Parameter	Min	Typ	Max	Unit	Test Conditions/Comments
ANALOG INPUT					
<i>Requirement</i>					
Single-Ended Input Voltage Range	0	2.5	2.75	V	ADC0_V _{IN,00-11} , ADC1_V _{IN,00-11} For input voltage >2.5 V, must use external voltage reference (input mode)
<i>Characteristic</i>					
DC Leakage Current			±1	μA	
Input Resistance		85		Ω	See Figure 5 on Page 6
Input Capacitance		9.0		pF	Condition 1 = track, See Figure 5 on Page 6
		1.5		pF	Condition 2 = hold, includes all parasitic capacitances, See Figure 5 on Page 6
VOLTAGE REFERENCE (OUTPUT MODE)					
<i>Characteristic</i>					
Output Voltage		2.5 ± 0.25%		V	V _{REF0} , V _{REF1}
Output Voltage Thermal Hysteresis		50		ppm	
Output Impedance		0.5	1.0	Ω	
Temperature Coefficient		20		ppm/°C	T _J = -40°C to +125°C
VOLTAGE REFERENCE (INPUT MODE)					
<i>Requirement</i>					
Input Voltage Range	0	2.5	2.75	V	V _{REF0} , V _{REF1} Requires 750 μA capable source current
DC Leakage Current			300	μA	
Input Capacitance		0.6		pF	
STATIC PERFORMANCE					
DC ACCURACY					
<i>Characteristic</i>					
Resolution		16		Bits	ADC0_V _{IN,00-11} , ADC1_V _{IN,00-11} No missing codes, natural binary coding
ADSP-CM403F/ADSP-CM408F/ ADSP-CM409F					
Differential Nonlinearity (DNL)	-0.99		+1.5	LSB	See Figure 12 on Page 71
Integral Nonlinearity (INL)		±3.0	±5.0	LSB	
Offset Error		±5.0	±10	LSB	
Offset Error Match		±2.0		LSB	Channel-to-channel, within one ADC
Offset Drift		±2.0		ppm/°C	
Gain Error		±32	±250	LSB	
Gain Error Match		±2.0		LSB	
ADSP-CM402F/ADSP-CM407F					
Differential Nonlinearity (DNL)	-0.99		+2.0	LSB	See Figure 12 on Page 71
Integral Nonlinearity (INL)		±10.0	±12.0	LSB	
Offset Error		±10.0	±12.0	LSB	
Offset Error Match		±2.0		LSB	Channel-to-channel, within one ADC
Offset Drift		±2.0		ppm/°C	
Gain Error		±64	±300	LSB	
Gain Error Match		±2.0		LSB	

ADSP-CM402F/CM403F/CM407F/CM408F/CM409F

Parameter	Min	Typ	Max	Unit	Test Conditions/Comments	
DYNAMIC PERFORMANCE						
Throughput					ADC0_V _{IN,00-11} , ADC1_V _{IN,00-11}	
Conversion Rate			2.63	MSPS		
Acquisition time		150		ns		
AC ACCURACY						
<i>Characteristic</i>						
ADSP-CM403F/ADSP-CM408F/ ADSP-CM409F						
Signal-to-Noise Ratio (SNR) ¹	80.25	81.25		dB	V _{IN} = V _{REF} /2 (dc)	
Signal-to-(Noise + Distortion) Ratio (SINAD) ¹	80	81		dB		
Total Harmonic Distortion (THD) ¹		-92		dB		
Spurious-Free Dynamic Range (SFDR) ¹		90		dBc		
Dynamic Range	82	83		dB		
Effective Number of Bits (ENOB)	13.0	13.2		Bits		
ADSP-CM402F/ADSP-CM407F						
Signal-to-Noise Ratio (SNR) ¹	73	74		dB		
Signal-to-(Noise + Distortion) Ratio (SINAD) ¹	72	73		dB		
Total Harmonic Distortion (THD) ¹		-88		dB		
Spurious-Free Dynamic Range (SFDR) ¹		88		dBc		
Dynamic Range	74.5	75.5		dB	V _{IN} = V _{REF} /2 (dc)	
Effective Number of Bits (ENOB)	11.6	11.8		Bits		
Channel-to-Channel Isolation		-95		dB	Any channel pair referenced on same ADC Selected channel = 1 kHz, unselected channel = 10 kHz	
ADC-to-ADC Isolation		-100		dB	Any channel pair referenced on opposite ADC	

¹ f_{IN} = 1 kHz, 0 V to 2.5 V input, 2.63 MSPS.

ADSP-CM402F/CM403F/CM407F/CM408F/CM409F

DAC Specifications

Typical values assume $V_{DD_ANA} = 3.3\text{ V}$, $V_{REF} = 2.5\text{ V}$.

Parameter	Min	Typ	Max	Unit	Test Conditions/Comments
ANALOG OUTPUT					
<i>Characteristic</i>					
Output Voltage Range		0.1 to 2.5		V	DAC0_VOUT, DAC1_VOUT
Output Impedance		0.6		Ω	Normal operation DAC @ full scale DAC @ zero scale
		2		Ω	
		10		Ω	
Update Rate			50	kHz	
Short Circuit Current to GND		30		mA	
Short Circuit Current to V_{DD}		30		mA	
STATIC PERFORMANCE					
DC ACCURACY					
<i>Characteristic</i>					
Resolution		12		Bits	$R_L = 500\ \Omega$, $C_L = 100\ \text{pF}$
Differential Nonlinearity (DNL)		± 0.99	$-0.99/+1.2$	LSB	Guaranteed monotonic
Integral Nonlinearity (INL)		± 2.0	± 3.5	LSB	
Offset Error		± 1.0		mV	Measured at Code 0x000
Gain Error		± 4.0		% FSR	% of full scale, measured at Code 0xFFFF
DC Isolation			50	μV	Static output of DAC0_VOUT while DAC1_VOUT toggles 0 to full scale
DYNAMIC PERFORMANCE					
AC ACCURACY					
<i>Characteristic</i>					
Signal-to-Noise Ratio (SNR)		67	65	dB	$R_L = 500\ \Omega$, $C_L = 100\ \text{pF}$
Signal-to-(Noise + Distortion) Ratio (SINAD)		62	59	dB	
Total Harmonic Distortion		63		dB	
Dynamic Range		68		dB	
Settling Time		1.5		μs	From $\frac{1}{4}$ to $\frac{3}{4}$ full scale
Slew Rate		1.5		$\text{V}/\mu\text{s}$	
D/A Glitch Energy		8		nV-s	Measured when code changes from 0x7FF to 0x800

ADSP-CM402F/CM403F/CM407F/CM408F/CM409F

ADC Typical Performance Characteristics

$V_{DD_ANA} = 3.3\text{ V}$, $V_{REF} = 2.5\text{ V}$, $T_j = 25^\circ\text{C}$, unless otherwise noted.

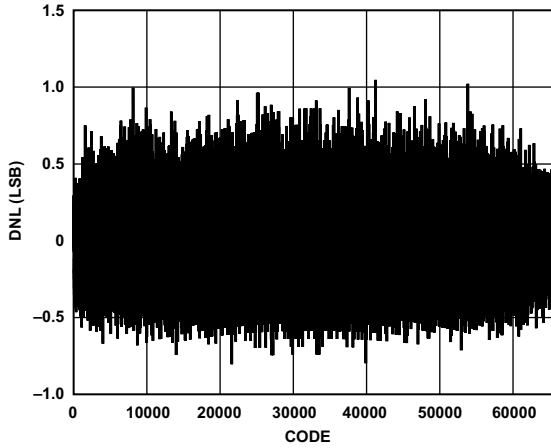

Figure 12. DNL vs. Code

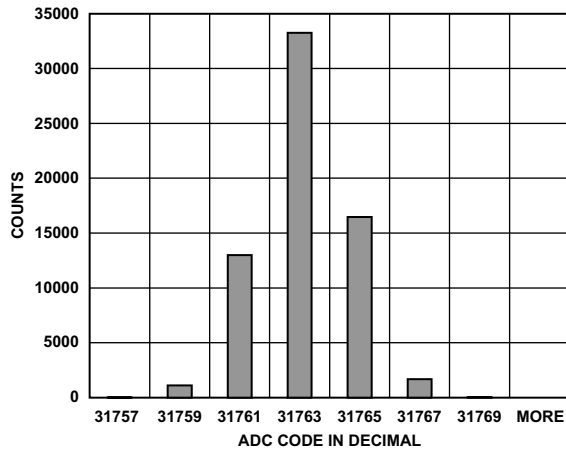

Figure 13. Histogram of DC Input at Code Center (Internal Reference)

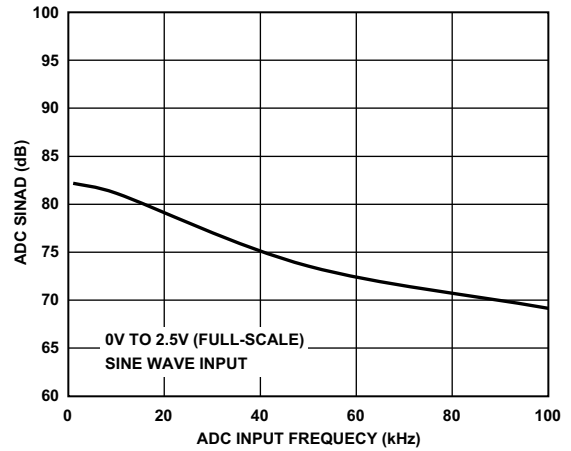

Figure 14. SINAD vs. Frequency, 0 V to 2.5 V Sine Wave Input

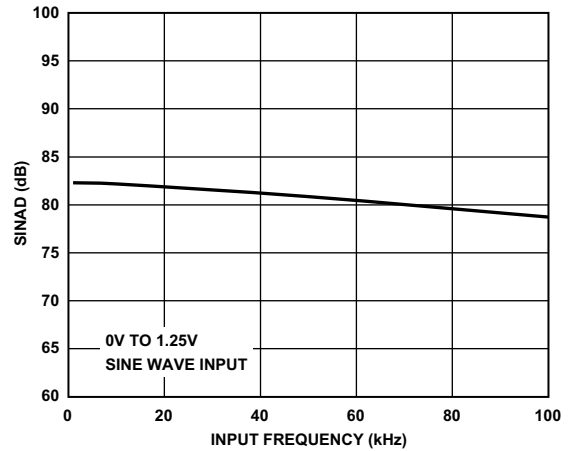

Figure 15. SINAD vs. Frequency, 0 V to 1.25 V Sine Wave Input

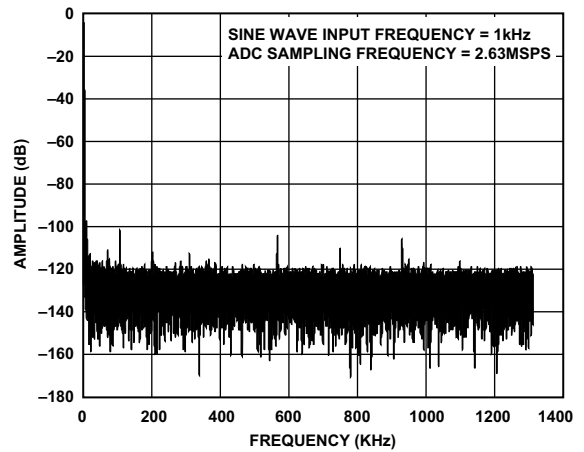

Figure 16. FFT Plot (Internal Reference)

ADSP-CM402F/CM403F/CM407F/CM408F/CM409F

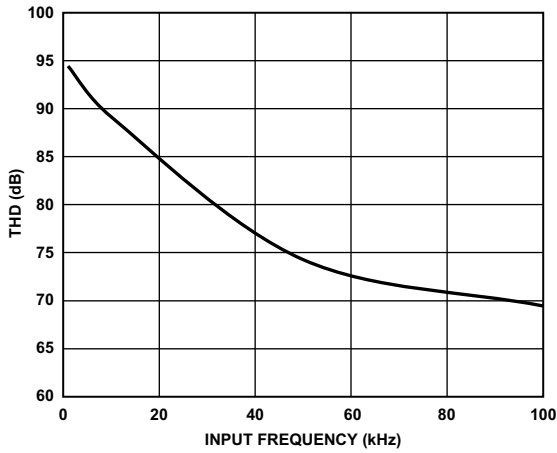

Figure 17. THD vs. Frequency, 0 V to 2.5 V Sine Wave Input

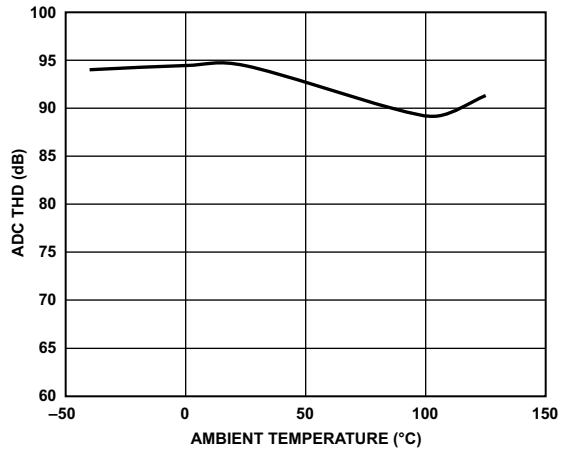

Figure 20. ADC THD vs. Temperature, 0 V to 2.5 V (1 kHz) Sine Wave Input

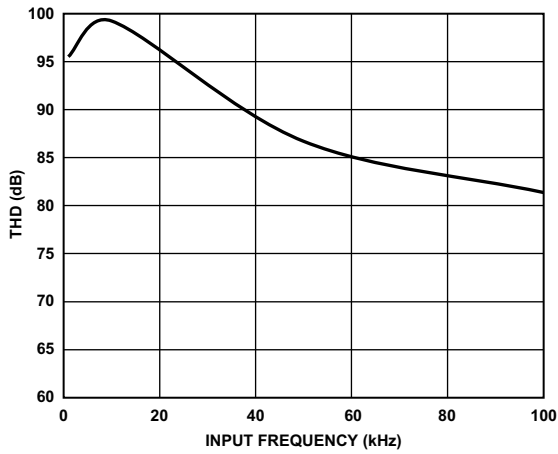

Figure 18. THD vs. Frequency, 0 V to 1.25 V Sine Wave Input

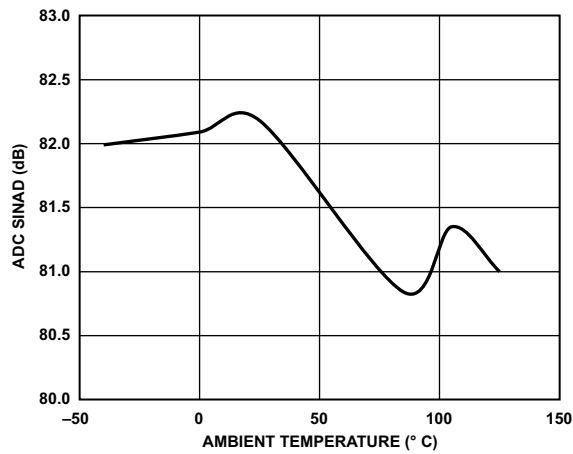

Figure 19. ADC SINAD vs. Temperature, 0 V to 2.5 V (1 kHz) Sine Wave Input

ADSP-CM402F/CM403F/CM407F/CM408F/CM409F

DAC Typical Performance Characteristics

$V_{DD_ANA} = 3.3\text{ V}$, $V_{REF} = 2.5\text{ V}$, $T_j = 25^\circ\text{C}$, unless otherwise noted.

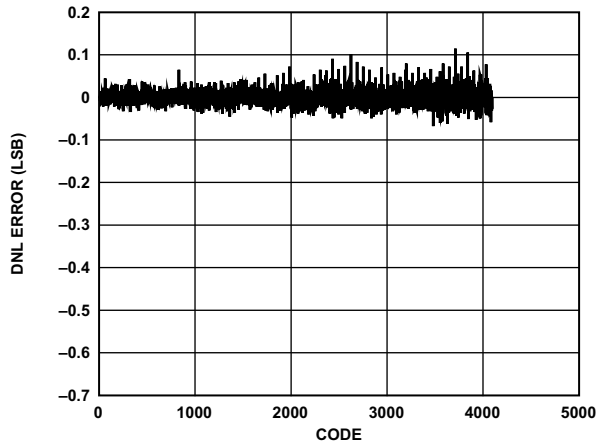

Figure 21. DAC DNL Error vs. Code

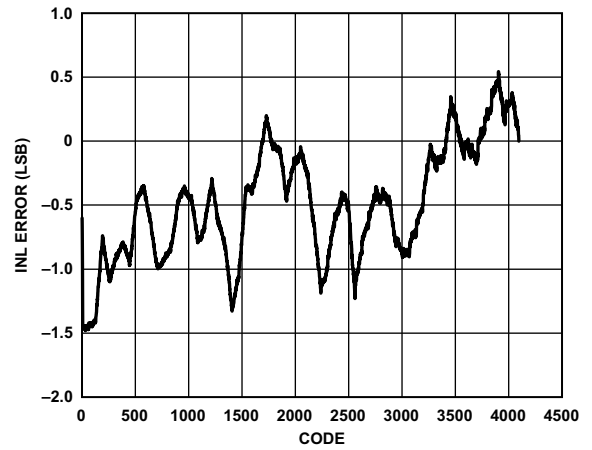

Figure 22. DAC INL Error vs. Code

ADSP-CM402F/CM403F/CM407F/CM408F/CM409F

FLASH SPECIFICATIONS

The Flash features include:

- 100,000 ERASE cycles per sector
- 20 years data retention

Flash PROGRAM/ERASE SUSPEND Command

Table 29 lists parameters for the Flash suspend command.

Table 29. Suspend Parameters

Parameter	Condition	Typ	Max	Unit
Erase to Suspend ¹	Sector erase or erase resume to erase suspend	700	–	μs
Program to Suspend ¹	Program resume to program suspend	5	–	μs
Subsector Erase to Suspend ¹	Subsector erase or subsector erase resume to erase suspend	50	–	μs
Suspend Latency ²	Program	7	–	μs
Suspend Latency ²	Subsector erase	15	–	μs
Suspend Latency ³	Erase	15	–	μs

¹Timing is not internally controlled.

²Any read command accepted.

³Any command except the following are accepted: sector, subsector, or bulk erase; write status register.

Flash AC Characteristics and Operating Conditions

Table 30 identifies Flash specific operating conditions.

Table 30. AC Characteristics and Operating Conditions

Parameter	Symbol	Min	Typ ¹	Max	Unit
Clock Frequency for All Commands other than Read (SPI-ER, QIO-SPI Protocol), T _J = 105°C	f _C	DC	–	100	MHz
Clock Frequency for All Commands other than Read (SPI-ER, QIO-SPI Protocol), T _J = 125°C	f _C	DC	–	97	MHz
Clock Frequency for Read Commands, T _J = 105°C	f _R	DC	–	50	MHz
Clock Frequency for Read Commands, T _J = 125°C	f _R	DC	–	45	MHz
Page Program Cycle Time (256 bytes) ²	t _{PP}	–	0.5	5	ms
Page Program Cycle Time (n bytes) ^{2,3}	t _{PP}	–	int(n/8) × 0.015	5	ms
Subsector Erase Cycle Time	t _{SSE}	–	0.3	1.5	sec
Sector Erase Cycle Time	t _{SE}	–	0.7	3	sec
Bulk Erase Cycle Time	t _{BE}	–	170	250	sec

¹Typical values given for T_J = 25°C.

²When using the page program command to program consecutive bytes, optimized timings are obtained with one sequence including all the bytes vs. several sequences of only a few bytes (1 < n < 256).

³int(A) corresponds to the upper integer part of A. For example int(12/8) = 2, int(32/8) = 4 int(15.3) = 16.

ADSP-CM402F/CM403F/CM407F/CM408F/CM409F

ABSOLUTE MAXIMUM RATINGS

Stresses at or above those listed in [Table 31](#) may cause permanent damage to the product. This is a stress rating only; functional operation of the product at these or any other conditions above those indicated in the operational section of this specification is not implied. Operation beyond the maximum operating conditions for extended periods may affect product reliability.

Table 31. Absolute Maximum Ratings

Parameter	Rating
Internal Supply Voltage (V_{DD_INT})	-0.33 V to +1.32 V
External (I/O) Supply Voltage (V_{DD_EXT})	-0.33 V to +3.63 V
Analog Supply Voltage (V_{DD_ANA})	-0.33 V to +3.63 V
Digital Input Voltage ^{1,2}	-0.33 V to +3.63 V
TWI Digital Input Voltage ^{1,2,3}	-0.33 V to +5.50 V
Digital Output Voltage Swing	-0.33 V to $V_{DD_EXT} + 0.5$ V
Analog Input Voltage ⁴	-0.33 V to +3.63 V
Voltage Reference Input Voltage (V_{REF0} , V_{REF1}) ⁴	-0.33 V to +2.75 V
USB0_Dx Input	-0.33 V to +5.25 V
USB0_VBUS Input Voltage	-0.33 V to +6.00 V
I_{OH}/I_{OL} Current per Signal ¹	6 mA (max)
Storage Temperature Range	-65°C to +150°C
Junction Temperature While Biased	+125°C

¹ Applies to 100% transient duty cycle. For other duty cycles, see [Table 32](#).

² Applies only when V_{DD_EXT} is within specifications. When V_{DD_EXT} is outside specifications, the range is $V_{DD_EXT} \pm 0.2$ V.

³ Applies to pins TWI_SCL and TWI_SDA.

⁴ Applies only when V_{DD_ANA} is within specification. When V_{DD_ANA} is outside specifications, the range is $V_{DD_ANA} \pm 0.2$ V.

Table 32. Maximum Duty Cycle for Input Transient Voltage¹

Maximum Duty Cycle (%) ²	V_{IN} Min (V) ³	V_{IN} Max (V) ³
100	-0.33	+3.63
50	-0.46	+3.78
40	-0.52	+3.85
25	-0.63	+3.96
20	-0.67	+3.99
15	-0.70	+4.03
10	-0.73	+4.07

¹ Applies to all signal pins with the exception of SYS_CLKIN, SYS_XTAL, USB0_DP, USB0_DM, USB0_VBUS, and TWI signals.

² Applies only when V_{DD_EXT} is within specifications. When V_{DD_EXT} is outside specifications, the range is $V_{DD_EXT} \pm 0.2$ V.

³ The individual values cannot be combined for analysis of a single instance of overshoot or undershoot. The worst case observed value must fall within one of the specified voltages, and the total duration of the overshoot or undershoot (exceeding the 100% case) must be less than or equal to the corresponding duty cycle.

ESD SENSITIVITY



ESD (electrostatic discharge) sensitive device. Charged devices and circuit boards can discharge without detection. Although this product features patented or proprietary protection circuitry, damage may occur on devices subjected to high energy ESD. Therefore, proper ESD precautions should be taken to avoid performance degradation or loss of functionality.

PACKAGE INFORMATION

The information presented in [Figure 23](#) and [Table 33](#) provides details about package branding. For a complete listing of product availability, see [Ordering Guide on Page 124](#).



Figure 23. Product Information on Package¹

¹ Exact brand may differ, depending on package type.

Table 33. Package Brand Information

Brand Key	Field Description
ADSP-CM40xF	Product model
t	Temperature range
pp	Package type
Z	RoHS compliant designation
cc	See Ordering Guide
vvvvvv.x	Assembly lot code
n	Silicon revision
yyww	Date code

ADSP-CM402F/CM403F/CM407F/CM408F/CM409F

TIMING SPECIFICATIONS

Specifications are subject to change without notice.

Clock and Reset Timing

Table 34 and Figure 24 describe clock and reset operations related to the clock generation unit (CGU) and reset control unit (RCU). Per the CCLK, SCLK, USBCLK, and OCLK timing specifications in Table 27 Clock Related Operating Conditions, combinations of SYS_CLKIN and clock multipliers must not select clock rates in excess of the processor's maximum instruction rate.

Table 34. Clock and Reset Timing

Parameter		Min	Max	Unit
<i>Timing Requirements</i>				
f_{CKIN}	SYS_CLKIN Frequency (Using a Crystal) ^{1, 2, 3}	20	50	MHz
f_{CKIN}	SYS_CLKIN Frequency (Using a Crystal Oscillator) ^{1, 2, 3}	20	60	MHz
t_{CKINL}	SYS_CLKIN Low Pulse ¹	6.67		ns
t_{CKINH}	SYS_CLKIN High Pulse ¹	6.67		ns
t_{WRST}	$\overline{SYS_HWRST}$ Asserted Pulse Width Low ⁴	$11 \times t_{CKIN}$		ns

¹ Applies to PLL bypass mode and PLL nonbypass mode.

² The t_{CKIN} period (see Figure 24) equals $1/f_{CKIN}$.

³ If the CGU_CTL.DF bit is set, the minimum f_{CKIN} specification is 40 MHz.

⁴ Applies after power-up sequence is complete. See Table 35 and Figure 25 for power-up reset timing.



Figure 24. Clock and Reset Timing

ADSP-CM402F/CM403F/CM407F/CM408F/CM409F

Power-Up Reset Timing

Table 35 and Figure 25 show the relationship between power supply startup and processor reset timing, related to the clock generation unit (CGU) and reset control unit (RCU). In Figure 25, $V_{DD_SUPPLIES}$ are V_{DD_INT} , V_{DD_EXT} , V_{DD_VREG} , V_{DD_ANA0} , and V_{DD_ANA1} .

Table 35. Power-Up Reset Timing

Parameter	Min	Max	Unit
<i>Timing Requirement</i>			
$t_{RST_IN_PWR}$	$\overline{SYS_HWRST}$ and $\overline{JTG_TRST}$ Deasserted after V_{DD_INT} , V_{DD_EXT} , V_{DD_VREG} , V_{DD_ANA0} , V_{DD_ANA1} , and SYS_CLKIN are Stable and Within Specification		ns

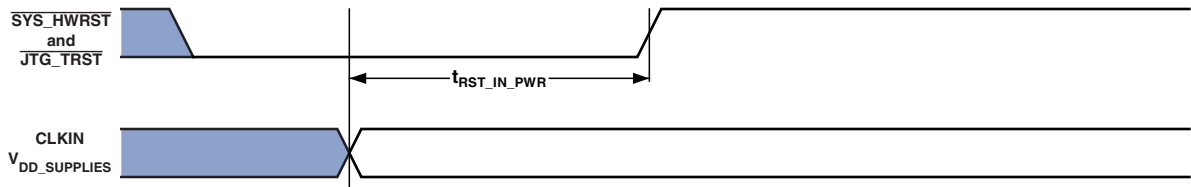

Figure 25. Power-Up Reset Timing

ADSP-CM402F/CM403F/CM407F/CM408F/CM409F

Asynchronous Read

Table 36 and Figure 26 show asynchronous memory read timing, related to the static memory controller (SMC).

Table 36. Asynchronous Memory Read (BxMODE = b#00)

Parameter	Min	Max	Unit
<i>Timing Requirements</i>			
$t_{SDATARE}$ DATA in Setup Before $\overline{SMC0_ARE}$ High	8.2		ns
$t_{HDATARE}$ DATA in Hold After $\overline{SMC0_ARE}$ High	0		ns
$t_{DARDYARE}$ $\overline{SMC0_ARDY}$ Valid After $\overline{SMC0_ARE}$ Low ^{1, 2}		$(RAT - 2.5) \times t_{SCLK} - 17.5$	ns
<i>Switching Characteristics</i>			
$t_{ADDRARE}$ $\overline{SMC0_Ax}/\overline{SMC0_AMSx}$ Assertion Before $\overline{SMC0_ARE}$ Low ³	$(PREST + RST + PREAT) \times t_{SCLK} - 3$		ns
t_{AOEARE} $\overline{SMC0_AOE}$ Assertion Before $\overline{SMC0_ARE}$ Low	$(RST + PREAT) \times t_{SCLK} - 3$		ns
t_{HARE} Output ⁴ Hold After $\overline{SMC0_ARE}$ High ⁵	$RHT \times t_{SCLK} - 2$		ns
t_{WARE} $\overline{SMC0_ARE}$ Active Low Width ⁶	$RAT \times t_{SCLK} - 2$		ns
$t_{DAREARDY}$ $\overline{SMC0_ARE}$ High Delay After $\overline{SMC0_ARDY}$ Assertion ¹	$2.5 \times t_{SCLK}$	$3.5 \times t_{SCLK} + 17.5$	ns

¹ SMC0_BxCTL.ARDYEN bit = 1.

² RAT value set using the SMC_BxTIM.RAT bits.

³ PREST, RST, and PREAT values set using the SMC_BxETIM.PREST bits, SMC_BxTIM.RST bits, and the SMC_BxETIM.PREAT bits.

⁴ Output signals are SMC0_Ax, SMC0_AMS, SMC0_AOE.

⁵ RHT value set using the SMC_BxTIM.RHT bits.

⁶ SMC0_BxCTL.ARDYEN bit = 0.



Figure 26. Asynchronous Read

ADSP-CM402F/CM403F/CM407F/CM408F/CM409F

Asynchronous Flash Read

Table 37 and Figure 27 show asynchronous flash memory read timing, related to the static memory controller (SMC).

Table 37. Asynchronous Flash Read

Parameter		Min	Max	Unit
<i>Switching Characteristics</i>				
t_{AMSADV}	SMC0_Ax (Address)/ $\overline{SMC0_AMSx}$ Assertion Before $\overline{SMC0_AOE}$ Low ¹	$PREST \times t_{SCLK} - 2$		ns
t_{WADV}	$\overline{SMC0_AOE}$ Active Low Width ²	$RST \times t_{SCLK} - 3$		ns
$t_{DADVARE}$	$\overline{SMC0_ARE}$ Low Delay From $\overline{SMC0_AOE}$ High ³	$PREAT \times t_{SCLK} - 3$		ns
t_{HARE}	Output ⁴ Hold After $\overline{SMC0_ARE}$ High ⁵	$RHT \times t_{SCLK} - 2$		ns
t_{WARE} ⁶	$\overline{SMC0_ARE}$ Active Low Width ⁷	$RAT \times t_{SCLK} - 2$		ns

¹ PREST value set using the SMC_BxETIM.PREST bits.

² RST value set using the SMC_BxTIM.RST bits.

³ PREAT value set using the SMC_BxETIM.PREAT bits.

⁴ Output signals are SMC0_Ax, SMC0_AMS.

⁵ RHT value set using the SMC_BxTIM.RHT bits.

⁶ SMC0_BxCTL.ARDYEN bit = 0.

⁷ RAT value set using the SMC_BxTIM.RAT bits.



Figure 27. Asynchronous Flash Read

ADSP-CM402F/CM403F/CM407F/CM408F/CM409F

Asynchronous Page Mode Read

Table 38 and Figure 28 show asynchronous memory page mode read timing, related to the static memory controller (SMC).

Table 38. Asynchronous Page Mode Read

Parameter	Min	Max	Unit
<i>Switching Characteristics</i>			
t_{AV}	SMC0_Ax (Address) Valid for First Address Min Width ¹	$(PREST + RST + PREAT + RAT) \times t_{SCLK} - 2$	ns
t_{AV1}	SMC0_Ax (Address) Valid for Subsequent SMC0_Ax (Address) Min Width	$PGWS \times t_{SCLK} - 2$	ns
t_{WADV}	$\overline{SMC0_AOE}$ Active Low Width ²	$RST \times t_{SCLK} - 3$	ns
t_{HARE}	Output ³ Hold After $\overline{SMC0_ARE}$ High ⁴	$RHT \times t_{SCLK} - 2$	ns
t_{WARE} ⁵	$\overline{SMC0_ARE}$ Active Low Width ⁶	$RAT \times t_{SCLK} - 2$	ns

¹ PREST, RST, PREAT and RAT values set using the SMC_BxETIM.PREST bits, SMC_BxTIM.RST bits, SMC_BxETIM.PREAT bits, and the SMC_BxTIM.RAT bits.

² RST value set using the SMC_BxTIM.RST bits.

³ Output signals are SMC0_Ax, SMC0_AMSx.

⁴ RHT value set using the SMC_BxTIM.RHT bits.

⁵ SMC_BxCTL.ARDYEN bit = 0.

⁶ RAT value set using the SMC_BxTIM.RAT bits.



Figure 28. Asynchronous Page Mode Read

ADSP-CM402F/CM403F/CM407F/CM408F/CM409F

Asynchronous Write

Table 39 and Figure 29 show asynchronous memory write timing, related to the static memory controller (SMC).

Table 39. Asynchronous Memory Write (BxMODE = b#00)

Parameter	Min	Max	Unit
<i>Timing Requirement</i>			
$t_{DARDYAWE}^1$ SMC0_ARDY Valid After $\overline{SMC0_AWE}$ Low ²		$(WAT - 2.5) \times t_{SCLK} - 17.5$	ns
<i>Switching Characteristics</i>			
t_{ENDAT} DATA Enable After $\overline{SMC0_AMSx}$ Assertion	-3		ns
t_{DDAT} DATA Disable After $\overline{SMC0_AMSx}$ Deassertion		3	ns
t_{AMSAWE} SMC0_Ax/ $\overline{SMC0_AMSx}$ Assertion Before $\overline{SMC0_AWE}$ Low ³	$(PREST + WST + PREAT) \times t_{SCLK} - 6.4$		ns
t_{HAWE} Output ⁴ Hold After $\overline{SMC0_AWE}$ High ⁵	$WHT \times t_{SCLK} - 2$		ns
t_{WAVE}^6 $\overline{SMC0_AWE}$ Active Low Width ²	$WAT \times t_{SCLK} - 2$		ns
$t_{DAWEARDY}^1$ $\overline{SMC0_AWE}$ High Delay After SMC0_ARDY Assertion	$2.5 \times t_{SCLK}$	$3.5 \times t_{SCLK} + 17.5$	ns

¹ SMC_BxCTL.ARDYEN bit = 1.

² WAT value set using the SMC_BxTIM.WAT bits.

³ PREST, WST, PREAT values set using the SMC_BxETIM.PREST bits, SMC_BxTIM.WST bits, SMC_BxETIM.PREAT bits, and the SMC_BxTIM.RAT bits.

⁴ Output signals are DATA, SMC0_Ax, $\overline{SMC0_AMSx}$, SMC0_ABE_x.

⁵ WHT value set using the SMC_BxTIM.WHT bits.

⁶ SMC_BxCTL.ARDYEN bit = 0.



Figure 29. Asynchronous Write

ADSP-CM402F/CM403F/CM407F/CM408F/CM409F

Asynchronous Flash Write

Table 40 and Figure 30 show asynchronous flash memory write timing, related to the static memory controller (SMC).

Table 40. Asynchronous Flash Write

Parameter	Min	Max	Unit
<i>Switching Characteristics</i>			
t_{AMSADV}	SMC0_Ax/SMC0_AMSx Assertion Before SMC0_AOE Low ¹		ns
$t_{DADVAVE}$	SMC0_AWE Low Delay From SMC0_AOE High ²		ns
t_{WADV}	SMC0_AOE Active Low Width ³		ns
t_{HAWE}	Output ⁴ Hold After SMC0_AWE High ⁵		ns
t_{WAVE} ⁶	SMC0_AWE Active Low Width ⁷		ns

¹ PREST value set using the SMC_BxETIM.PREST bits.

² PREAT value set using the SMC_BxETIM.PREAT bits.

³ WST value set using the SMC_BxTIM.WST bits.

⁴ Output signals are DATA, SMC0_Ax, SMC0_AMSx.

⁵ WHT value set using the SMC_BxTIM.WHT bits.

⁶ SMC_BxCTL.ARDYEN bit = 0.

⁷ WAT value set using the SMC_BxTIM.WAT bits.



Figure 30. Asynchronous Flash Write

All Accesses

Table 41 describes timing that applies to all memory accesses, related to the static memory controller (SMC).

Table 41. All Accesses

Parameter	Min	Max	Unit
<i>Switching Characteristic</i>			
t_{TURN}	SMC0_AMSx Inactive Width		ns
	$(IT + TT) \times t_{SCLK} - 2$		

ADSP-CM402F/CM403F/CM407F/CM408F/CM409F

Serial Ports

To determine whether serial port (SPORT) communication is possible between two devices at clock speed n , the following specifications must be confirmed: 1) frame sync delay and frame sync setup and hold, 2) data delay and data setup and hold, and 3) serial clock (SPT_CLK) width. In [Figure 31](#) either the rising edge or the falling edge of SPT_CLK (external or internal) can be used as the active sampling edge.

When externally generated the SPORT clock is called $f_{SPTCLKEXT}$:

$$t_{SPTCLKEXT} = \frac{1}{f_{SPTCLKEXT}}$$

When internally generated, the programmed SPORT clock ($f_{SPTCLKPROG}$) frequency in MHz is set by the following equation where CLKDIV is a field in the SPORT_DIV register that can be set from 0 to 65,535:

$$f_{SPTCLKPROG} = \frac{f_{SCLK}}{(CLKDIV + 1)}$$

$$t_{SPTCLKPROG} = \frac{1}{f_{SPTCLKPROG}}$$

Table 42. Serial Ports—External Clock

Parameter	Min	Max	Unit
<i>Timing Requirements</i>			
t_{SFSE} Frame Sync Setup Before SPT_CLK (Externally Generated Frame Sync in either Transmit or Receive Mode) ¹	2		ns
t_{HFSE} Frame Sync Hold After SPT_CLK (Externally Generated Frame Sync in either Transmit or Receive Mode) ¹	2.7		ns
t_{SDRE} Receive Data Setup Before Receive SPT_CLK ¹	2		ns
t_{HDRE} Receive Data Hold After SPT_CLK ¹	2.7		ns
t_{SCLKW} SPT_CLK Width ²	$0.5 \times t_{SPTCLKEXT} - 1$		ns
t_{SPTCLK} SPT_CLK Period ²	$t_{SPTCLKEXT} - 1$		ns
<i>Switching Characteristics</i>			
t_{DFSE} Frame Sync Delay After SPT_CLK (Internally Generated Frame Sync in either Transmit or Receive Mode) ³		14.5	ns
t_{HOFSE} Frame Sync Hold After SPT_CLK (Internally Generated Frame Sync in either Transmit or Receive Mode) ³	2		ns
t_{DDTE} Transmit Data Delay After Transmit SPT_CLK ³		14	ns
t_{HDTE} Transmit Data Hold After Transmit SPT_CLK ³	2		ns

¹ Referenced to sample edge.

² This specification indicates the minimum instantaneous width or period that can be tolerated due to duty cycle variation or jitter on the external SPT_CLK. For the external SPT_CLK maximum frequency, see the $f_{SPTCLKEXT}$ specification in [Table 27 Clock Related Operating Conditions](#).

³ Referenced to drive edge.

ADSP-CM402F/CM403F/CM407F/CM408F/CM409F

Table 43. Serial Ports—Internal Clock

Parameter	Min	Max	Unit
<i>Timing Requirements</i>			
t_{SFSI}	12		ns
	Frame Sync Setup Before SPT_CLK (Externally Generated Frame Sync in either Transmit or Receive Mode) ¹		
t_{HFSI}	-0.5		ns
	Frame Sync Hold After SPT_CLK (Externally Generated Frame Sync in either Transmit or Receive Mode) ¹		
t_{SDRI}	3.4		ns
	Receive Data Setup Before SPT_CLK ¹		
t_{HDRI}	1.5		ns
	Receive Data Hold After SPT_CLK ¹		
<i>Switching Characteristics</i>			
t_{DFSI}		3.5	ns
	Frame Sync Delay After SPT_CLK (Internally Generated Frame Sync in Transmit or Receive Mode) ²		
t_{HOFSI}	-1		ns
	Frame Sync Hold After SPT_CLK (Internally Generated Frame Sync in Transmit or Receive Mode) ²		
t_{DDTI}		3.5	ns
	Transmit Data Delay After SPT_CLK ²		
t_{HDTI}	-1.25		ns
	Transmit Data Hold After SPT_CLK ²		
t_{SCLKIW}	$0.5 \times t_{SPTCLKPROG} - 1$		ns
	SPT_CLK Width ³		
t_{SPTCLK}	$t_{SPTCLKPROG} - 1$		ns
	SPT_CLK Period ³		

¹ Referenced to the sample edge.

² Referenced to drive edge.

³ See [Table 27 Clock Related Operating Conditions](#) for details on the minimum period that may be programmed for $f_{SPTCLKPROG}$.

ADSP-CM402F/CM403F/CM407F/CM408F/CM409F

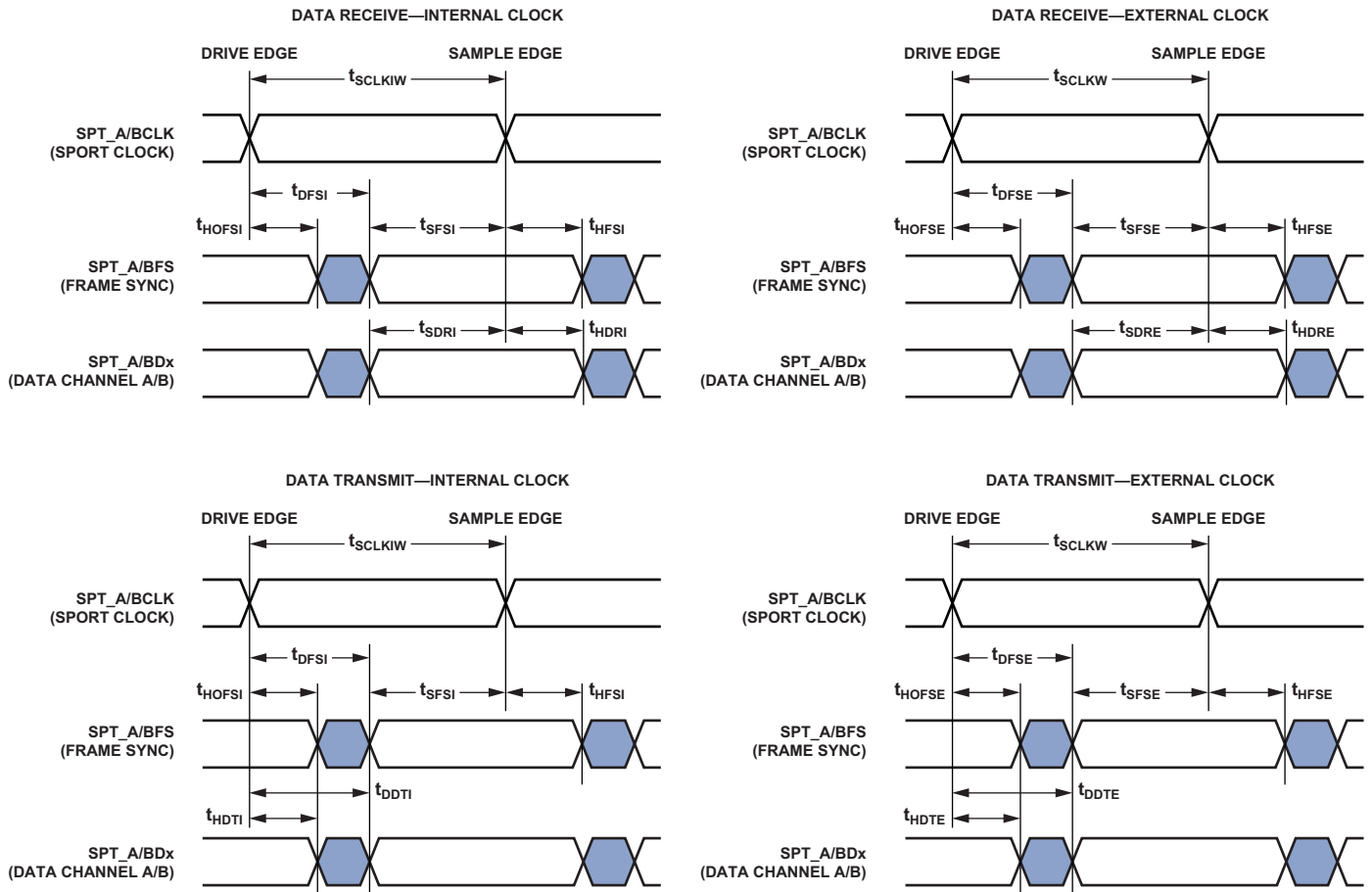

Figure 31. Serial Ports

ADSP-CM402F/CM403F/CM407F/CM408F/CM409F

Table 44. Serial Ports—Enable and Three-State

Parameter		Min	Max	Unit
<i>Switching Characteristics</i>				
t_{DDTEN}	Data Enable from External Transmit SPT_CLK ¹	1		ns
t_{DDTTE}	Data Disable from External Transmit SPT_CLK ¹		14	ns
t_{DDTIN}	Data Enable from Internal Transmit SPT_CLK ¹	-1		ns
t_{DDTTI}	Data Disable from Internal Transmit SPT_CLK ¹		2.8	ns

¹ Referred to drive edge.

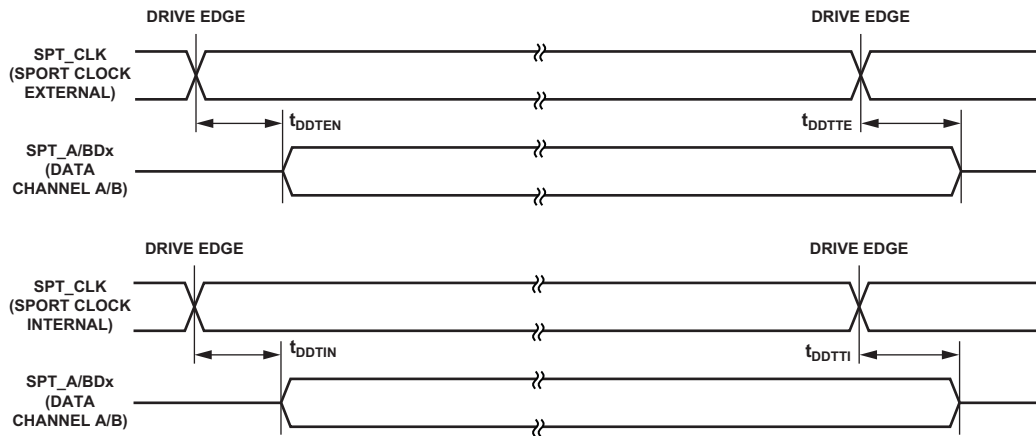

Figure 32. Serial Ports—Enable and Three-State

ADSP-CM402F/CM403F/CM407F/CM408F/CM409F

The SPT_TDV output signal becomes active in SPORT multichannel mode. During transmit slots (enabled with active channel selection registers) the SPT_TDV is asserted for communication with external devices.

Table 45. Serial Ports—Transmit Data Valid (TDV)

Parameter	Min	Max	Unit
<i>Switching Characteristics</i>			
t_{DRDVEN} Data-Valid Enable Delay from Drive Edge of External Clock ¹	2		ns
t_{DFDVEN} Data-Valid Disable Delay from Drive Edge of External Clock ¹		14	ns
t_{DRDVIN} Data-Valid Enable Delay from Drive Edge of Internal Clock ¹	-1		ns
t_{DFDVIN} Data-Valid Disable Delay from Drive Edge of Internal Clock ¹		3.5	ns

¹ Referenced to drive edge.

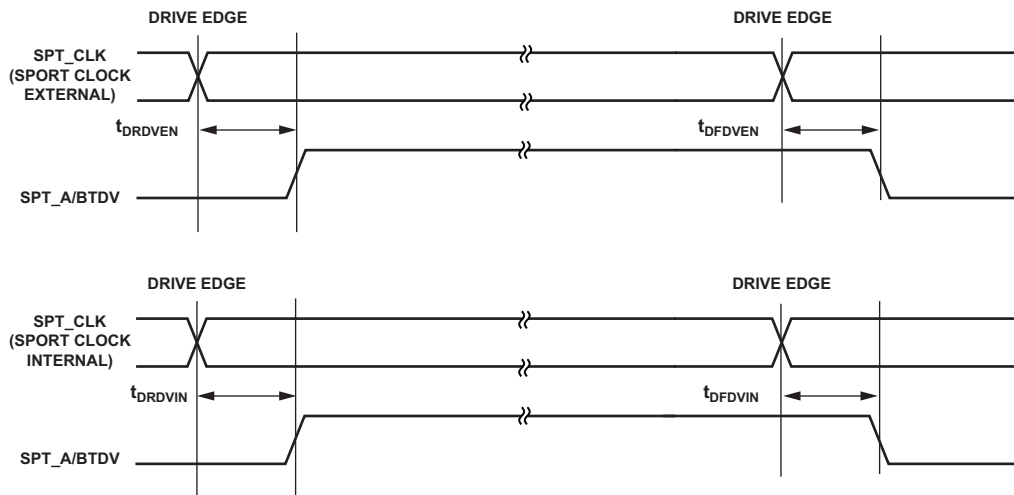

Figure 33. Serial Ports—Transmit Data Valid Internal and External Clock

ADSP-CM402F/CM403F/CM407F/CM408F/CM409F

Table 46. Serial Ports—External Late Frame Sync

Parameter	Min	Max	Unit
<i>Switching Characteristics</i>			
$t_{DDTLFSE}$ Data and Data-Valid Enable Delay from Late External Transmit Frame Sync or External Receive Frame Sync with MCE = 1, MFD = 0 ¹		14	ns
$t_{DDTENFS}$ Data Enable for MCE = 1, MFD = 0 ¹	0.5		ns

¹The $t_{DDTLFSE}$ and $t_{DDTENFS}$ parameters apply to left-justified as well as standard serial mode, and MCE = 1, MFD = 0.



Figure 34. External Late Frame Sync

ADSP-CM402F/CM403F/CM407F/CM408F/CM409F

Serial Peripheral Interface (SPI) Port—Master Timing

Table 47 and Figure 35 describe serial peripheral interface (SPI) port master operations. When internally generated, the programmed SPI clock ($f_{SPICLKPROG}$) frequency in MHz is set by the following equation where BAUD is a field in the SPI_CLK register that can be set from 0 to 65,535:

$$f_{SPICLKPROG} = \frac{f_{SCLK}}{(BAUD + 1)}$$

$$t_{SPICLKPROG} = \frac{1}{f_{SPICLKPROG}}$$

Note that:

- In dual mode data transmit, the SPI_MISO signal is also an output.
- In quad mode data transmit, the SPI_MISO, SPI_D2, and SPI_D3 signals are also outputs.
- In dual mode data receive, the SPI_MOSI signal is also an input.
- In quad mode data receive, the SPI_MOSI, SPI_D2, and SPI_D3 signals are also inputs.

Table 47. Serial Peripheral Interface (SPI) Port—Master Timing

Parameter		Min	Max	Unit
<i>Timing Requirements</i>				
t_{SSPIDM}	Data Input Valid to SPI_CLK Edge (Data Input Setup)	3.2		ns
t_{HSPIDM}	SPI_CLK Sampling Edge to Data Input Invalid	1.3		ns
<i>Switching Characteristics</i>				
t_{SDSCIM}	$\overline{SPI_SEL}$ low to First SPI_CLK Edge for CPHA = 1 ¹	[$t_{SCLK} - 2$] or [18]		ns
	$\overline{SPI_SEL}$ low to First SPI_CLK Edge for CPHA = 0 ¹	[$1.5 \times t_{SCLK} - 2$] or [13]		ns
t_{SPICHM}	SPI_CLK High Period ²	$0.5 \times t_{SPICLKPROG} - 1$		ns
t_{SPICLM}	SPI_CLK Low Period ²	$0.5 \times t_{SPICLKPROG} - 1$		ns
t_{SPICLK}	SPI_CLK Period ²	$t_{SPICLKPROG} - 1$		ns
t_{HDMSM}	Last SPI_CLK Edge to $\overline{SPI_SEL}$ High for CPHA = 1 ¹	[$1.5 \times t_{SCLK} - 2$] or [13]		ns
	Last SPI_CLK Edge to $\overline{SPI_SEL}$ High for CPHA = 0 ¹	[$t_{SCLK} - 2$] or [18]		ns
t_{SPITDM}	Sequential Transfer Delay ^{1,3}	[$t_{SCLK} - 1$] or [19]		ns
$t_{DDSPIDM}$	SPI_CLK Edge to Data Out Valid (Data Out Delay)		2.6	ns
$t_{HDSPIDM}$	SPI_CLK Edge to Data Out Invalid (Data Out Hold)	-1.5		ns

¹ Whichever is greater.

² See Table 27 Clock Related Operating Conditions for details on the minimum period that may be programmed for $t_{SPICLKPROG}$.

³ Applies to sequential mode with STOP ≥ 1 .

ADSP-CM402F/CM403F/CM407F/CM408F/CM409F

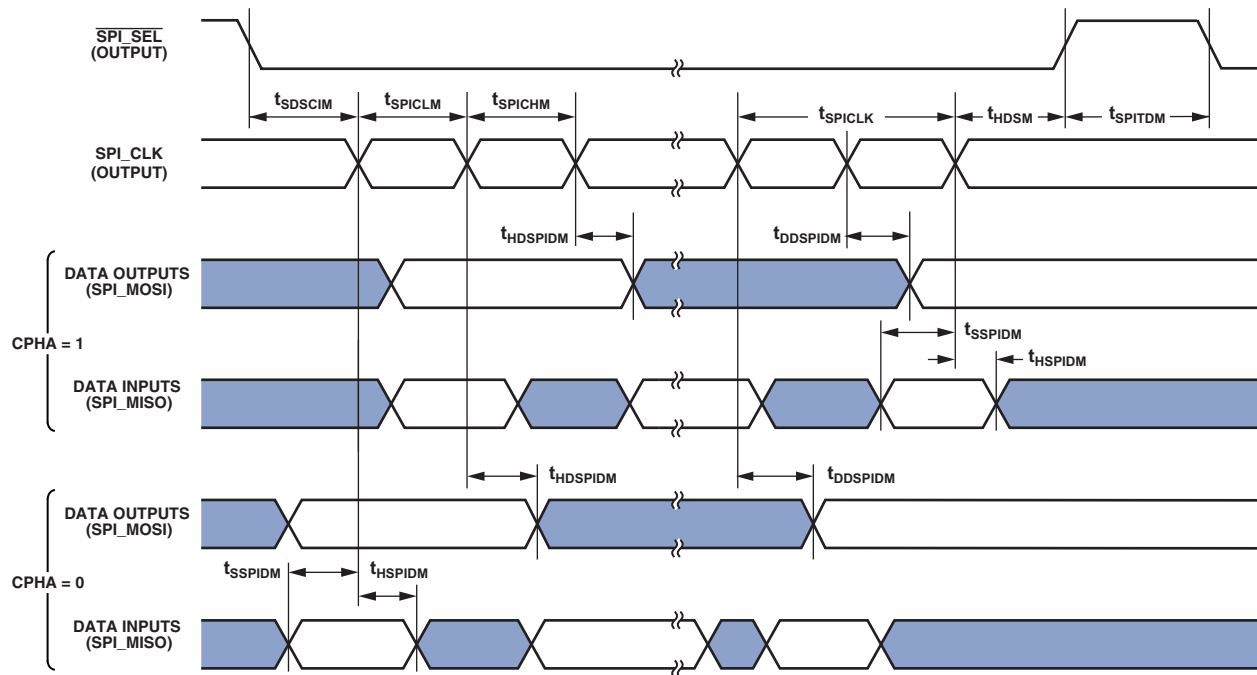

Figure 35. Serial Peripheral Interface (SPI) Port—Master Timing

ADSP-CM402F/CM403F/CM407F/CM408F/CM409F

Serial Peripheral Interface (SPI) Port—Slave Timing

Table 48 and Figure 36 describe serial peripheral interface (SPI) port slave operations. Note that:

- In dual mode data transmit, the SPI_MOSI signal is also an output.
- In quad mode data transmit, the SPI_MOSI, SPI_D2, and SPI_D3 signals are also outputs.
- In dual mode data receive, the SPI_MISO signal is also an input.
- In quad mode data receive, the SPI_MISO, SPI_D2, and SPI_D3 signals are also inputs.
- In SPI slave mode, the SPI clock is supplied externally and is called $f_{SPICLKEXT}$:

$$t_{SPICLKEXT} = \frac{1}{f_{SPICLKEXT}}$$

Table 48. Serial Peripheral Interface (SPI) Port—Slave Timing

Parameter	Min	Max	Unit
<i>Timing Requirements</i>			
t_{SPICH5} SPI_CLK High Period ¹	$0.5 \times t_{SPICLKEXT} - 1$		ns
t_{SPICLS} SPI_CLK Low Period ¹	$0.5 \times t_{SPICLKEXT} - 1$		ns
t_{SPICLK} SPI_CLK Period ¹	$t_{SPICLKEXT} - 1$		ns
t_{HDS} Last SPI_CLK Edge to $\overline{SPI_SS}$ Not Asserted	5		ns
t_{SPITDS} Sequential Transfer Delay	$t_{SPICLK} - 1$		ns
t_{SDSCI} $\overline{SPI_SS}$ Assertion to First SPI_CLK Edge	10.5		ns
t_{SSPID} Data Input Valid to SPI_CLK Edge (Data Input Setup)	2		ns
t_{HSPID} SPI_CLK Sampling Edge to Data Input Invalid	1.6		ns
<i>Switching Characteristics</i>			
t_{DSOE} $\overline{SPI_SS}$ Assertion to Data Out Active	0	14	ns
t_{DSDHI} $\overline{SPI_SS}$ Deassertion to Data High Impedance	0	12.5	ns
t_{DDSPID} SPI_CLK Edge to Data Out Valid (Data Out Delay)		14	ns
t_{HDSPID} SPI_CLK Edge to Data Out Invalid (Data Out Hold)	0		ns

¹This specification indicates the minimum instantaneous width or period that can be tolerated due to duty cycle variation or jitter on the external SPI_CLK. For the external SPI_CLK maximum frequency see the $t_{SPICLKEXT}$ specification in [Table 27 Clock Related Operating Conditions](#).

ADSP-CM402F/CM403F/CM407F/CM408F/CM409F

Serial Peripheral Interface (SPI) Port—SPI_RDY Slave Timing

Table 49. SPI Port—SPI_RDY Slave Timing

Parameter		Min	Max	Unit
<i>Switching Characteristics</i>				
$t_{\text{DSPISCKRDYSR}}$	SPI_RDY De-assertion from Last Input SPI_CLK Edge in Slave Mode Receive	$3 \times t_{\text{SCLK}}$	$4 \times t_{\text{SCLK}} + 10$	ns
$t_{\text{DSPISCKRDYST}}$	SPI_RDY De-assertion from Last Input SPI_CLK Edge in Slave Mode Transmit	$4 \times t_{\text{SCLK}}$	$5 \times t_{\text{SCLK}} + 10$	ns

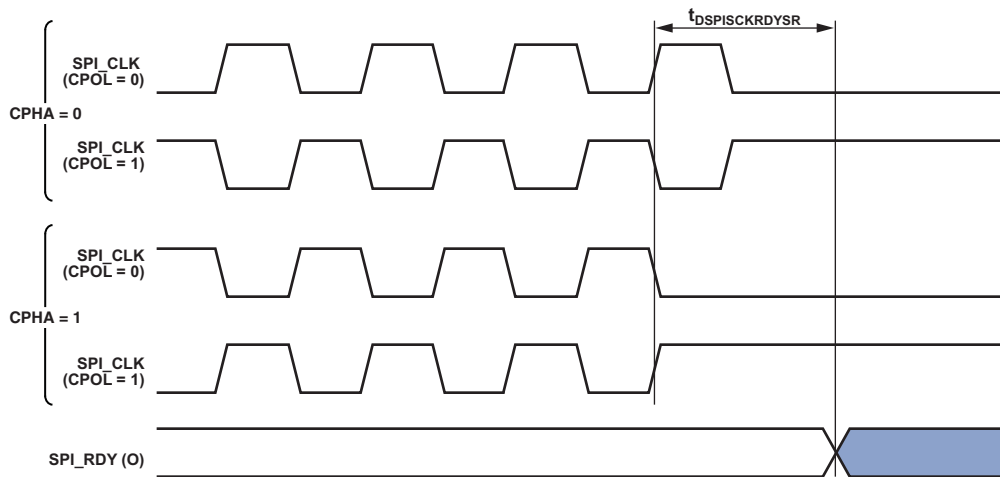

Figure 37. SPI_RDY De-assertion from Valid Input SPI_CLK Edge in Slave Mode Receive (FCCH = 0)



Figure 38. SPI_RDY De-assertion from Valid Input SPI_CLK Edge in Slave Mode Transmit (FCCH = 1)

ADSP-CM402F/CM403F/CM407F/CM408F/CM409F

Serial Peripheral Interface (SPI) Port—Open Drain Mode (ODM) Timing

In Figure 39 and Figure 40, the outputs can be SPI_MOSI, SPI_MISO, SPI_D2, and/or SPI_D3 depending on the mode of operation.

Table 50. SPI Port—ODM Master Mode

Parameter	Min	Max	Unit
<i>Switching Characteristics</i>			
$t_{\text{HDSPIODMM}}$ SPI_CLK Edge to High Impedance from Data Out Valid	-1		ns
$t_{\text{DDSPIODMM}}$ SPI_CLK Edge to Data Out Valid from High Impedance		6	ns

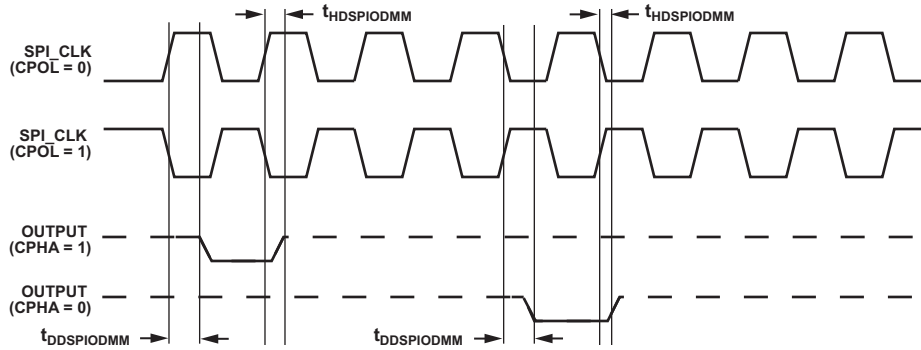

Figure 39. ODM Master

Table 51. SPI Port—ODM Slave Mode

Parameter	Min	Max	Unit
<i>Timing Requirements</i>			
$t_{\text{HDSPIODMS}}$ SPI_CLK Edge to High Impedance from Data Out Valid	0		ns
$t_{\text{DDSPIODMS}}$ SPI_CLK Edge to Data Out Valid from High Impedance		11	ns

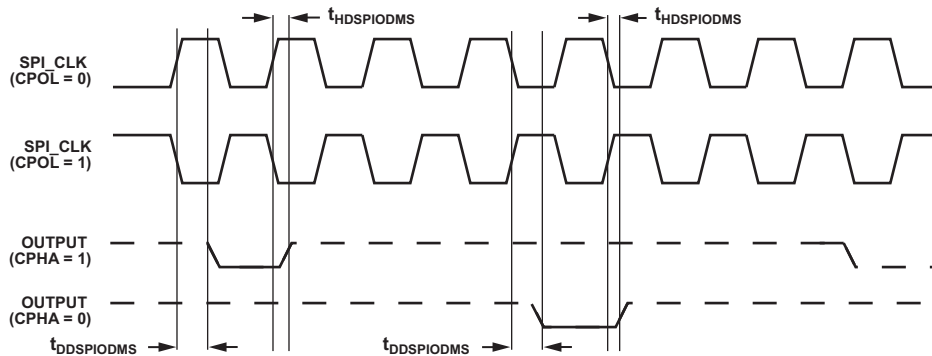

Figure 40. ODM Slave

ADSP-CM402F/CM403F/CM407F/CM408F/CM409F

Serial Peripheral Interface (SPI) Port—SPI_RDY Master Timing

SPI_RDY is used to provide flow control. The CPOL and CPHA bits are set in SPI_CTL, while LEADX, LAGX, and STOP are in SPI_DLY.

Table 52. SPI Port—SPI_RDY Master Timing

Parameter	Min	Max	Unit
<i>Timing Requirements</i>			
$t_{SRDYSCKM0}$ Minimum Setup Time for SPI_RDY De-assertion in Master Mode Before Last Valid SPI_CLK Edge of Valid Data Transfer to Block Subsequent Transfer with CPHA = 0	$(2 + 2 \times \text{BAUD}^1) \times t_{SCLK} + 10$		ns
$t_{SRDYSCKM1}$ Minimum Setup Time for SPI_RDY De-assertion in Master Mode Before Last Valid SPI_CLK Edge of Valid Data Transfer to Block Subsequent Transfer with CPHA = 1	$(2 + 2 \times \text{BAUD}^1) \times t_{SCLK} + 10$		ns
<i>Switching Characteristics</i>			
$t_{SRDYSCKM}$ Time Between Assertion of SPI_RDY by Slave and First Edge of SPI_CLK for New SPI Transfer with CPHA/CPOL = 0 and BAUD = 0 (STOP, LEAD, LAG = 0)	$4.5 \times t_{SCLK}$	$5.5 \times t_{SCLK} + 10$	ns
Time Between Assertion of SPI_RDY by Slave and First Edge of SPI_CLK for New SPI Transfer with CPHA/CPOL = 1 and BAUD = 0 (STOP, LEAD, LAG = 0)	$4 \times t_{SCLK}$	$5 \times t_{SCLK} + 10$	ns
Time Between Assertion of SPI_RDY by Slave and First Edge of SPI_CLK for New SPI Transfer with CPHA/CPOL = 0 and BAUD ≥ 1 (STOP, LEAD, LAG = 0)	$(1 + 1.5 \times \text{BAUD}^1) \times t_{SCLK}$	$(2 + 2.5 \times \text{BAUD}^1) \times t_{SCLK} + 10$	ns
Time Between Assertion of SPI_RDY by Slave and First Edge of SPI_CLK for New SPI Transfer with CPHA/CPOL = 1 and BAUD ≥ 1 (STOP, LEAD, LAG = 0)	$(1 + 1 \times \text{BAUD}^1) \times t_{SCLK}$	$(2 + 2 \times \text{BAUD}^1) \times t_{SCLK} + 10$	ns

¹ BAUD value set using the SPI_CLK.BAUD bits. BAUD value = SPI_CLK.BAUD bits + 1.

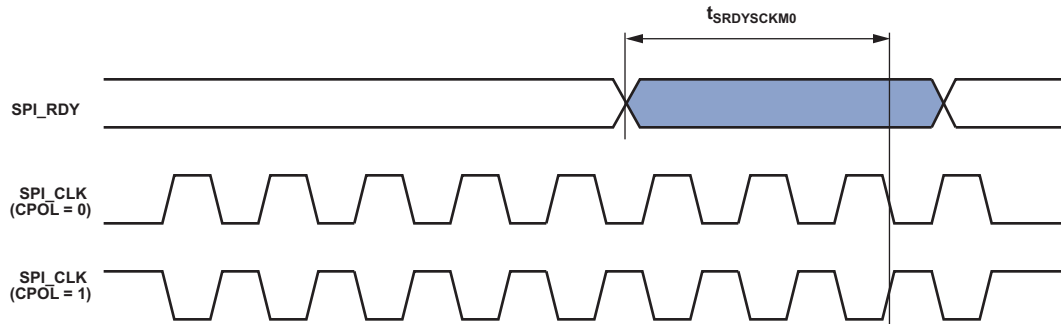

Figure 41. SPI_RDY Setup Before SPI_CLK with CPHA = 0

ADSP-CM402F/CM403F/CM407F/CM408F/CM409F

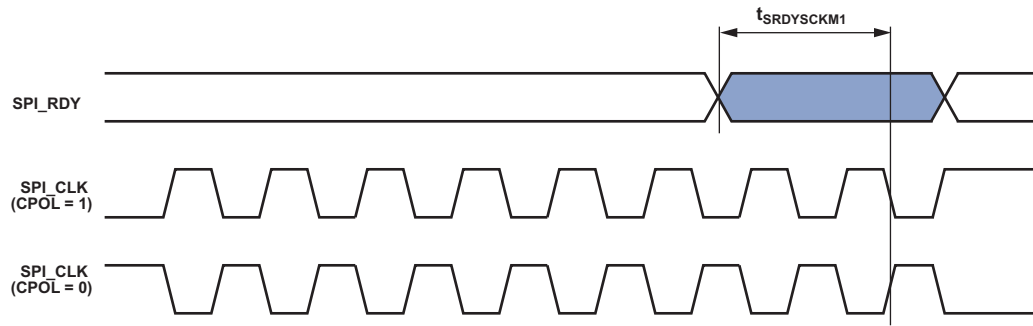

Figure 42. SPI_RDY Setup Before SPI_CLK with CPHA = 1

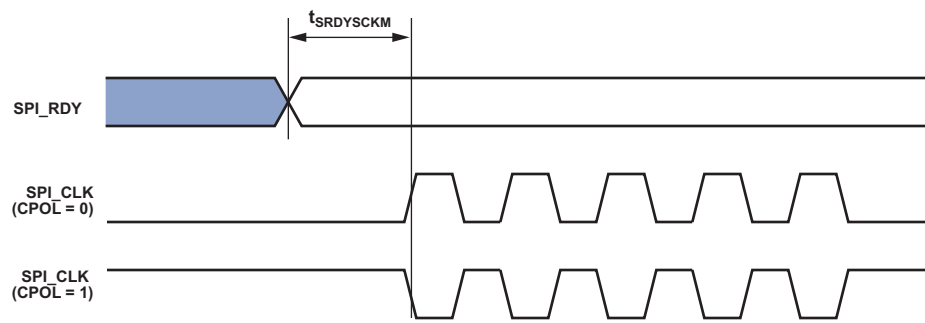

Figure 43. SPI_CLK Switching Diagram after SPI_RDY Assertion, CPHA = x

ADSP-CM402F/CM403F/CM407F/CM408F/CM409F

Serial Peripheral Interface (SPI) Port—Memory Map Mode Timing

Table 53. SPI Port—Memory Map Mode Timing

Parameter	Min	Max	Unit
<i>Switching Characteristic</i>			
$t_{ZDSPIDM}$ SPI_CLK Edge to Data-Out High Impedance	-1	+8	ns



Figure 44. SPI_CLK Valid Edge to Data-Out High Impedance in Master Mode with CPHA = 0



Figure 45. SPI_CLK Valid Edge to Data-Out High Impedance in Master Mode with CPHA = 1

ADSP-CM402F/CM403F/CM407F/CM408F/CM409F

General-Purpose I/O Port Timing

Table 54 and Figure 46 describe I/O timing, related to the general-purpose ports (PORT).

Table 54. General-Purpose I/O Port Timing

Parameter	Min	Max	Unit
<i>Timing Requirement</i>			
t_{WFI} General-Purpose I/O Port Pin Input Pulse Width	$2 \times t_{SCLK}$		ns



Figure 46. General-Purpose Port Timing

GPIO Timer Cycle Timing

Table 55, Table 56, and Figure 47 describe timer expired operations, related to the general-purpose timer (TIMER). The input signal is asynchronous in width capture mode and external clock mode and has an absolute maximum input frequency of ($f_{SCLK}/4$) MHz. The width value is the timer period assigned in the TMx_TMRn_WIDTH register and can range from 1 to $2^{32} - 1$. Note that when externally generated, the TMR clock is called $f_{TMRCLKEXT}$:

$$t_{TMRCLKEXT} = \frac{1}{f_{TMRCLKEXT}}$$

Table 55. Timer Cycle Timing (Internal Mode)

Parameter	Min	Max	Unit
<i>Timing Requirements</i>			
t_{WL} Timer Pulse Width Input Low (Measured In SCLK Cycles) ¹	$2 \times t_{SCLK}$		ns
t_{WH} Timer Pulse Width Input High (Measured In SCLK Cycles) ¹	$2 \times t_{SCLK}$		ns
<i>Switching Characteristic</i>			
t_{HTO} Timer Pulse Width Output (Measured In SCLK Cycles) ²	$t_{SCLK} \times WIDTH - 1.5$	$t_{SCLK} \times WIDTH + 1.5$	ns

¹ The minimum pulse width applies for TMx signals in width capture and external clock modes.

² WIDTH refers to the value in the $TMRx_WIDTH$ register (it can vary from 1 to $2^{32} - 1$).

Table 56. Timer Cycle Timing (External Mode)

Parameter	Min	Max	Unit
<i>Timing Requirements</i>			
t_{WL} Timer Pulse Width Input Low (Measured In EXT_CLK Cycles) ¹	$2 \times t_{EXT_CLK}$		ns
t_{WH} Timer Pulse Width Input High (Measured In EXT_CLK Cycles) ¹	$2 \times t_{EXT_CLK}$		ns
t_{EXT_CLK} Timer External Clock Period ²	$t_{TMRCLKEXT}$		ns
<i>Switching Characteristic</i>			
t_{HTO} Timer Pulse Width Output (Measured In EXT_CLK Cycles) ³	$t_{EXT_CLK} \times WIDTH - 1.5$	$t_{EXT_CLK} \times WIDTH + 1.5$	ns

¹ The minimum pulse width applies for TMx signals in width capture and external clock modes.

² This specification indicates the minimum instantaneous width or period that can be tolerated due to duty cycle variation or jitter on the external TMR_CLK. For the external TMR_CLK maximum frequency see the $f_{TMRCLKEXT}$ specification in Table 27 Clock Related Operating Conditions.

³ WIDTH refers to the value in the $TMRx_WIDTH$ register (it can vary from 1 to $2^{32} - 1$).

ADSP-CM402F/CM403F/CM407F/CM408F/CM409F

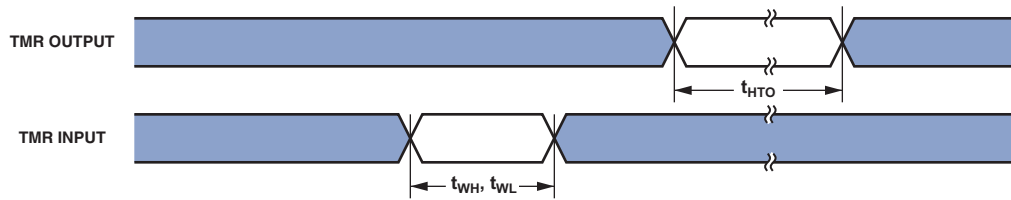

Figure 47. Timer Cycle Timing

Up/Down Counter/Rotary Encoder Timing

Table 57 and Figure 48 describe timing, related to the general-purpose counter (CNT).

Table 57. Up/Down Counter/Rotary Encoder Timing

Parameter	Min	Max	Unit
<i>Timing Requirement</i>			
t_{WCOUNT} Up/Down Counter/Rotary Encoder Input Pulse Width	$2 \times t_{SCLK}$		ns



Figure 48. Up/Down Counter/Rotary Encoder Timing

Pulse Width Modulator (PWM) Timing

Table 58 and Figure 49 describe timing, related to the pulse width modulator (PWM).

Table 58. PWM Timing

Parameter	Min	Max	Unit
<i>Timing Requirement</i>			
t_{ES} External Sync Pulse Width	$2 \times t_{SCLK}$		ns
<i>Switching Characteristics</i>			
t_{DODIS} Output Inactive (Off) After Trip Input ¹		15	ns
t_{DOE} Output Delay After External Sync ^{1,2}	$2 \times t_{SCLK} + 5.5$	$5 \times t_{SCLK} + 14$	ns

¹ PWM outputs are: PWMx_AH, PWMx_AL, PWMx_BH, PWMx_BL, PWMx_CH, PWMx_DH, PWMx_DL, and PWMx_CL.

² When the external sync signal is synchronous to the peripheral clock, it takes fewer clock cycles for the output to appear compared to when the external sync signal is asynchronous to the peripheral clock. For more information, see the *ADSP-CM40x Microcontroller Hardware Reference*.



Figure 49. PWM Timing

ADSP-CM402F/CM403F/CM407F/CM408F/CM409F

Pulse Width Modulator (PWM)—Heightened-Precision Mode Timing

Table 59, Table 60, Figure 50, and Figure 51 describe heightened-precision pulse width modulator (PWM) operations.

Table 59. PWM—Heightened-Precision Mode, Output Pulse

Parameter	Min	Max	Unit
<i>Switching Characteristic</i>			
t_{HPWMW} HP-PWM Output Pulse Width ^{1, 2}	$(N + m \times 0.25) \times t_{SCLK} - 0.5$	$(N + m \times 0.25) \times t_{SCLK} + 0.5$	ns

¹ N is the DUTY bit field (coarse duty) from the duty register. m is the ENHDIV (enhanced precision divider bits) value from the HP duty register.

² Applies to individual PWM channel with 50% duty cycle. Other PWM channels within the same unit are toggling at the same time. No other GPIO pins are toggling.

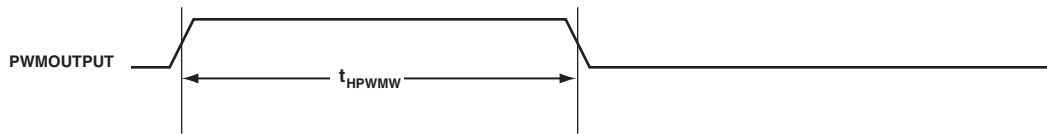

Figure 50. PWM Heightened-Precision Mode Timing, Output Pulse

Table 60. PWM—Heightened-Precision Mode, Output Skew

Parameter	Min	Max	Unit
<i>Switching Characteristic</i>			
t_{HPWMS} HP-PWM Output Skew ¹		1.0	ns

¹ Output edge difference between any two PWM channels (AH, AL, BH, BL, CH, CL, DH, and DL) in the same PWM unit (a unit is PWMx where x = 0, 1, 2), with the same heightened-precision edge placement.

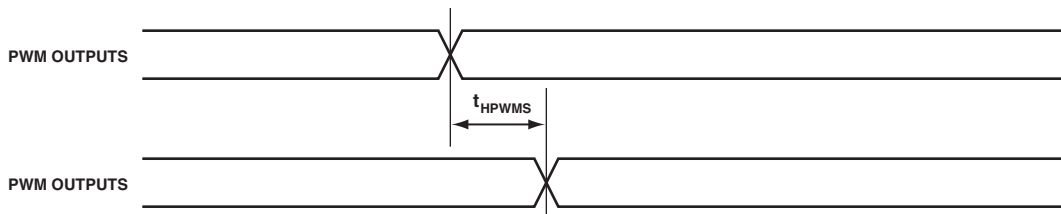

Figure 51. PWM Heightened-Precision Mode Timing, Output Skew

ADSP-CM402F/CM403F/CM407F/CM408F/CM409F

Universal Asynchronous Receiver-Transmitter (UART) Ports—Receive and Transmit Timing

The universal asynchronous receiver-transmitter (UART) ports receive and transmit operations are described in the *ADSP-CM40x Mixed-Signal Control Processor with ARM Cortex-M4 Hardware Reference*.

Controller Area Network (CAN) Interface

The controller area network (CAN) interface timing is described in the *ADSP-CM40x Mixed-Signal Control Processor with ARM Cortex-M4 Hardware Reference*.

Universal Serial Bus (USB) On-The-Go—Receive and Transmit Timing

The universal serial bus (USB) on-the-go receive and transmit operations are described in the *ADSP-CM40x Mixed-Signal Control Processor with ARM Cortex-M4 Hardware Reference*.

ADSP-CM402F/CM403F/CM407F/CM408F/CM409F

10/100 Ethernet MAC Controller (EMAC) Timing

Table 61 through Table 63 and Figure 52 through Figure 54 describe the 10/100 Ethernet MAC controller operations. Note the externally generated Ethernet MAC clock is called $f_{REFCLKEXT}$:

$$t_{REFCLKEXT} = \frac{1}{f_{REFCLKEXT}}$$

Table 61. 10/100 Ethernet MAC Controller (EMAC) Timing: RMI Receive Signal

Parameter ¹		Min	Max	Unit
<i>Timing Requirements</i>				
t_{REFCLK}	ETHx_REFCLK Period ²	$t_{REFCLKEXT} - 1\%$		ns
$t_{REFCLKW}$	ETHx_REFCLK Width ²	$t_{REFCLKEXT} \times 35\%$	$t_{REFCLKEXT} \times 65\%$	ns
$t_{REFCLKIS}$	Rx Input Valid to RMI ETHx_REFCLK Rising Edge (Data In Setup)	4		ns
$t_{REFCLKIH}$	RMI ETHx_REFCLK Rising Edge to Rx Input Invalid (Data In Hold)	2.0		ns

¹RMI inputs synchronous to RMI REF_CLK are ERxDx, RMI CRS_DV, and ERxER.

²This specification indicates the minimum instantaneous width or period that can be tolerated due to duty cycle variation or jitter on the external REF_CLK. For the external REF_CLK maximum frequency see the $t_{REFCLKEXT}$ specification in Table 27 Clock Related Operating Conditions.

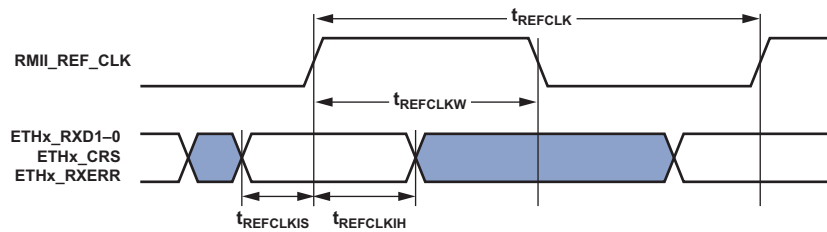

Figure 52. 10/100 Ethernet MAC Controller Timing: RMI Receive Signal

Table 62. 10/100 Ethernet MAC Controller (EMAC) Timing: RMI Transmit Signal

Parameter ¹		Min	Max	Unit
<i>Switching Characteristics</i>				
$t_{REFCLKOV}$	RMI ETHx_REFCLK Rising Edge to Transmit Output Valid (Data Out Valid)		14	ns
$t_{REFCLKOH}$	RMI ETHx_REFCLK Rising Edge to Transmit Output Invalid (Data Out Hold)	2		ns

¹RMI outputs synchronous to RMI REF_CLK are ETxDx.

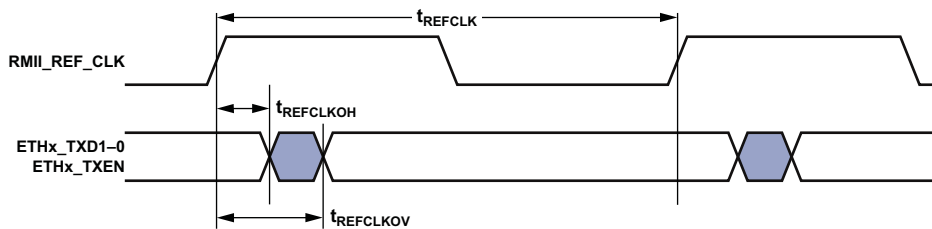

Figure 53. 10/100 Ethernet MAC Controller Timing: RMI Transmit Signal

ADSP-CM402F/CM403F/CM407F/CM408F/CM409F

Table 63. 10/100 Ethernet MAC Controller (EMAC) Timing: RMI Station Management

Parameter ¹	Min	Max	Unit
<i>Timing Requirements</i>			
t_{MDIOS} ETHx_MDIO Input Valid to ETHx_MDC Rising Edge (Setup)	14		ns
t_{MDCIH} ETHx_MDC Rising Edge to ETHx_MDIO Input Invalid (Hold)	0		ns
<i>Switching Characteristics</i>			
t_{MDCOV} ETHx_MDC Falling Edge to ETHx_MDIO Output Valid		$t_{SCLK} + 5$	ns
t_{MDCOH} ETHx_MDC Falling Edge to ETHx_MDIO Output Invalid (Hold)	$t_{SCLK} - 2.5$		ns

¹ETHx_MDC/ETHx_MDIO is a 2-wire serial bidirectional port for controlling one or more external PHYs. ETHx_MDC is an output clock whose minimum period is programmable as a multiple of the system clock SCLK. ETHx_MDIO is a bidirectional data line.



Figure 54. 10/100 Ethernet MAC Controller Timing: RMI Station Management

ADSP-CM402F/CM403F/CM407F/CM408F/CM409F

Sinus Cardinalis (SINC) Filter Timing

The programmed sinus cardinalis (SINC) filter clock ($f_{\text{SINCLKPROG}}$) frequency in MHz is set by the following equation where MDIV is a field in the CLK control register that can be set from 4 to 63:

$$f_{\text{SINCLKPROG}} = \frac{f_{\text{SCLK}}}{\text{MDIV}}$$

$$t_{\text{SINCLKPROG}} = \frac{1}{f_{\text{SINCLKPROG}}}$$

Table 64. SINC Filter Timing

Parameter		Min	Max	Unit
<i>Timing Requirements</i>				
t_{SSINC}	SINC0_Dx Setup Before SINC0_CLKx Rise	9		ns
t_{HSINC}	SINC0_Dx Hold After SINC0_CLKx Rise	0		ns
<i>Switching Characteristics</i>				
t_{SINCLK}	SINC0_CLKx Period ¹		$t_{\text{SINCLKPROG}} - 2.5$	ns
t_{SINCLKW}	SINC0_CLKx Width ¹		$0.5 \times t_{\text{SINCLKPROG}} - 2.5$	ns

¹ See [Table 27 Clock Related Operating Conditions](#) for details on the minimum period that may be programmed for $t_{\text{SINCLKPROG}}$.

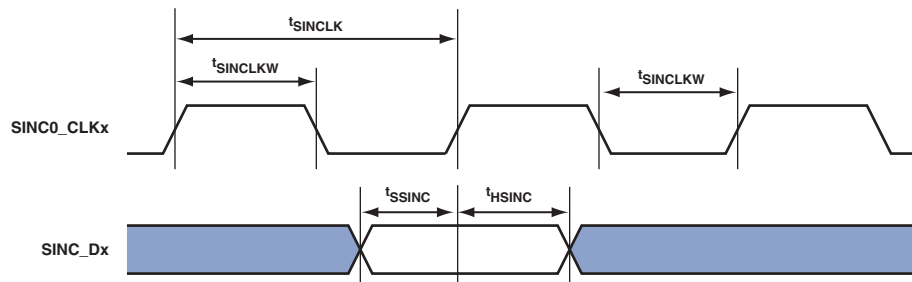

Figure 55. SINC Filter Timing

ADSP-CM402F/CM403F/CM407F/CM408F/CM409F

Trace Timing

Table 65. Trace Timing

Parameter		Min	Max	Unit
<i>Switching Characteristics</i>				
$t_{DDTRACE}$	Data Delay After TRACE_CLK		$0.5 \times t_{SCLK} + 2$	ns
$t_{HDTRACE}$	Data Hold After TRACE_CLK	$0.5 \times t_{SCLK} - 2$		ns



Figure 56. Trace Timing

Serial Wire Debug (SWD) Timing

Table 66 and Figure 57 describe the serial wire debug (SWD) operations.

Table 66. Serial Wire Debug (SWD) Timing

Parameter		Min	Max	Unit
<i>Timing Requirements</i>				
t_{SWCLK}	SWCLK Period	20		ns
t_{SSWDIO}	SWDIO Setup Before SWCLK High	4		ns
t_{HSWDIO}	SWDIO Hold After SWCLK High	4		ns
<i>Switching Characteristics</i>				
t_{DSWDIO}	SWDIO Delay After SWCLK High		12.5	ns
$t_{HOSWDIO}$	SWDIO Hold After SWCLK High	3.5		ns

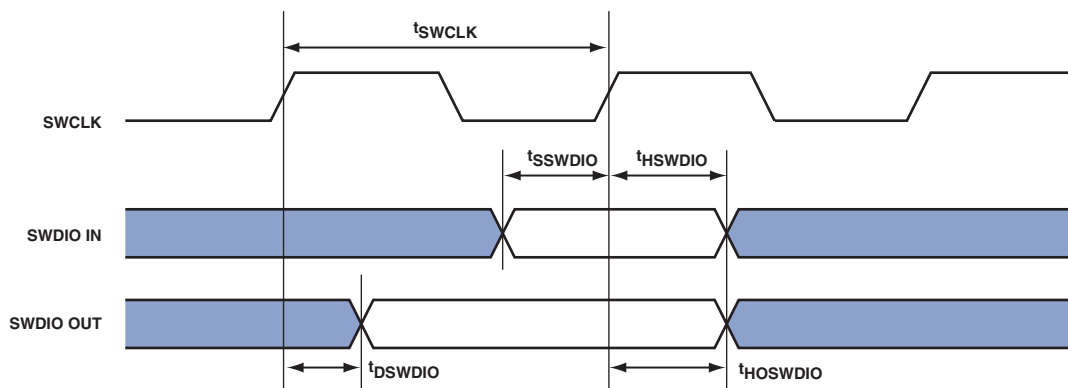

Figure 57. Serial Wire Debug (SWD) Timing

ADSP-CM402F/CM403F/CM407F/CM408F/CM409F

Debug Interface (JTAG Emulation Port) Timing

Table 67 and Figure 58 provide I/O timing, related to the debug interface (JTAG emulator port).

Table 67. JTAG Emulation Port Timing

Parameter		Min	Max	Unit
<i>Timing Requirements</i>				
t_{TCK}	JTG_TCK Period	20		ns
t_{STAP}	JTG_TDI, JTG_TMS Setup Before JTG_TCK High	4		ns
t_{HTAP}	JTG_TDI, JTG_TMS Hold After JTG_TCK High	4		ns
t_{SSYS}	System Inputs Setup Before JTG_TCK High ¹	12		ns
t_{HSYS}	System Inputs Hold After JTG_TCK High ¹	5		ns
t_{TRSTW}	JTG_TRST Pulse Width (Measured in JTG_TCK cycles) ²	4		t_{TCK}
<i>Switching Characteristics</i>				
t_{DTDO}	JTG_TDO Delay from JTG_TCK Low		13.5	ns
t_{DSYS}	System Outputs Delay After JTG_TCK Low ³		17	ns

¹ System inputs = PA_xx, PB_xx, PC_xx, PD_xx, PE_xx, PF_xx, SYS_BMODEx, SYS_HWRST, SYS_FAULT, SYS_NMI, TWI0_SCL, TWI0_SDA, USB_ID.

² 50 MHz maximum.

³ System outputs = PA_xx, PB_xx, PC_xx, PD_xx, PE_xx, PF_xx, SMC0_AMS0, SMC0_ARE, SMC0_AWE, SYS_CLKOUT, SYS_FAULT, SYS_RESOUT.



Figure 58. JTAG Emulation Port Timing

ADSP-CM402F/CM403F/CM407F/CM408F/CM409F

PROCESSOR TEST CONDITIONS

All timing parameters appearing in this data sheet were measured under the conditions described in this section. Figure 59 shows the measurement point for ac measurements (except output enable/disable). The measurement point V_{MEAS} is $V_{DD_EXT}/2$ for V_{DD_EXT} (nominal) = 3.3 V.

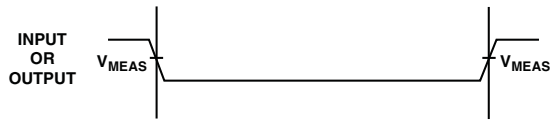

Figure 59. Voltage Reference Levels for AC Measurements (Except Output Enable/Disable)

Output Enable Time Measurement

Output pins are considered to be enabled when they have made a transition from a high impedance state to the point when they start driving.

The output enable time, t_{ENA} , is the interval from the point when a reference signal reaches a high or low voltage level to the point when the output starts driving as shown on the right side of Figure 60. If multiple pins are enabled, the measurement value is that of the first pin to start driving.

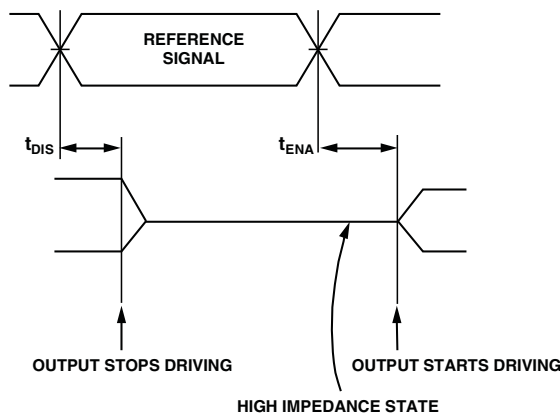

Figure 60. Output Enable/Disable

Output Disable Time Measurement

Output pins are considered to be disabled when they stop driving, go into a high impedance state, and start to decay from their output high or low voltage. The output disable time, t_{DIS} , is the interval from when a reference signal reaches a high or low voltage level to the point when the output stops driving as shown on the left side of Figure 60.

OUTPUT DRIVE CURRENTS

Figure 61 and Figure 62 show typical current-voltage characteristics for the output drivers of the processors. The curves represent the current drive capability of the output drivers as a function of output voltage.

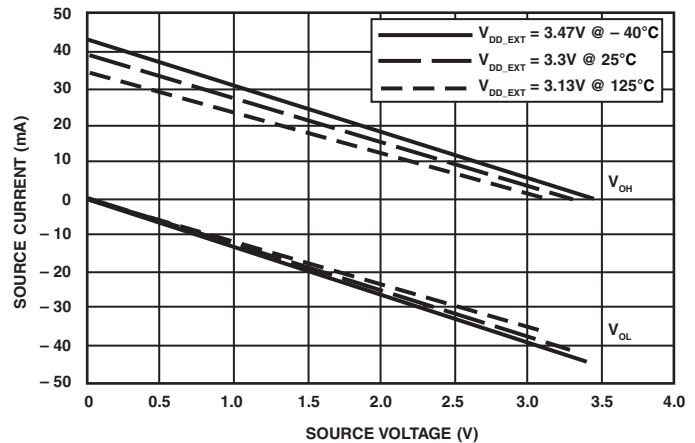

Figure 61. Driver Type A Current

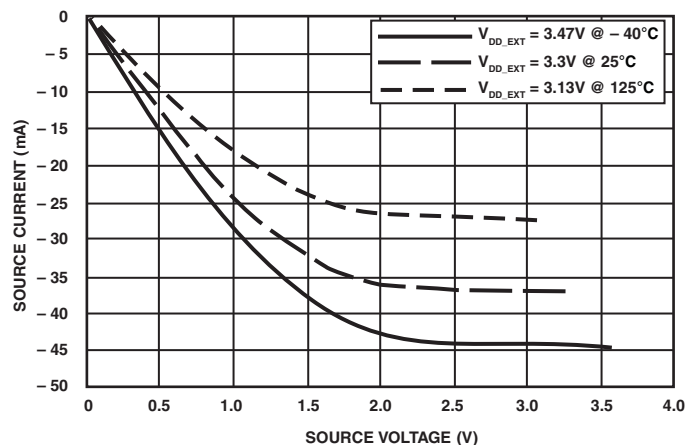
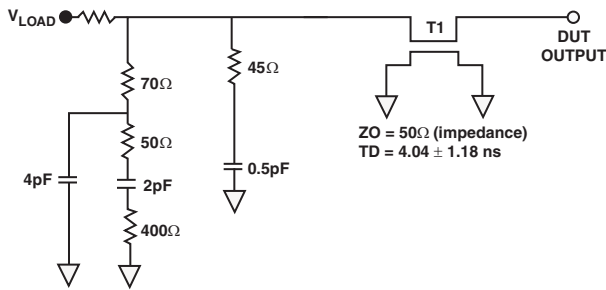

Figure 62. Driver Type B Current

Capacitive Loading

Output delay, hold, enable, and disable times are based on standard capacitive loads of an average of 6 pF on all pins (see Figure 63). V_{LOAD} is equal to $(V_{DD_EXT})/2$.

ADSP-CM402F/CM403F/CM407F/CM408F/CM409F



NOTES:
THE WORST CASE TRANSMISSION LINE DELAY IS SHOWN AND CAN BE USED FOR THE OUTPUT TIMING ANALYSIS TO REFLECT THE TRANSMISSION LINE EFFECT AND MUST BE CONSIDERED. THE TRANSMISSION LINE (TD), IS FOR LOAD ONLY AND DOES NOT AFFECT THE DATA SHEET TIMING SPECIFICATIONS.

ANALOG DEVICES RECOMMENDS USING THE IBIS MODEL TIMING FOR A GIVEN SYSTEM REQUIREMENT. IF NECESSARY, A SYSTEM MAY INCORPORATE EXTERNAL DRIVERS TO COMPENSATE FOR ANY TIMING DIFFERENCES.

Figure 63. Equivalent Device Loading for AC Measurements (Includes All Fixtures)

The graph of Figure 64 shows how output rise and fall times vary with capacitance. The delay and hold specifications given should be derated by a factor derived from these figures. The graphs in these figures may not be linear outside the ranges shown.

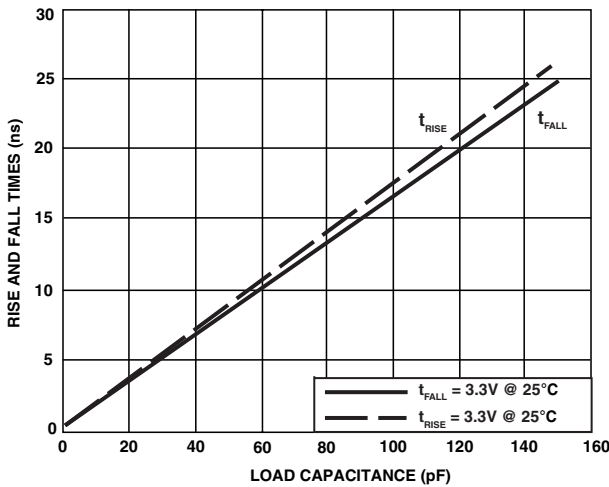

Figure 64. Driver Type A Typical Rise and Fall Times (10% to 90%) vs. Load Capacitance

ENVIRONMENTAL CONDITIONS

To determine the junction temperature on the application printed circuit board, use the following equation:

$$T_J = T_{CASE} + (\Psi_{JT} \times P_D)$$

where:

T_J = Junction temperature (°C).

T_{CASE} = Case temperature (°C) measured by customer at top center of package.

Ψ_{JT} = From Table 68, Table 69, and Table 70.

P_D = Power dissipation (see Total Power Dissipation (PD) on Page 67 for the method to calculate P_D).

Table 68. Thermal Characteristics (120-Lead LQFP)

Parameter	Condition	Typical	Unit
θ_{JA}	0 linear m/s air flow	21.5	°C/W
θ_{JA}	1 linear m/s air flow	19.2	°C/W
θ_{JA}	2 linear m/s air flow	18.4	°C/W
θ_{JC}		9.29	°C/W
Ψ_{JT}	0 linear m/s air flow	0.25	°C/W
Ψ_{JT}	1 linear m/s air flow	0.40	°C/W
Ψ_{JT}	2 linear m/s air flow	0.56	°C/W

Table 69. Thermal Characteristics (176-Lead LQFP)

Parameter	Condition	Typical	Unit
θ_{JA}	0 linear m/s air flow	21.5	°C/W
θ_{JA}	1 linear m/s air flow	19.3	°C/W
θ_{JA}	2 linear m/s air flow	18.5	°C/W
θ_{JC}		9.24	°C/W
Ψ_{JT}	0 linear m/s air flow	0.25	°C/W
Ψ_{JT}	1 linear m/s air flow	0.37	°C/W
Ψ_{JT}	2 linear m/s air flow	0.48	°C/W

Table 70. Thermal Characteristics (212-Ball BGA)

Parameter	Condition	Typical	Unit
θ_{JA}	0 linear m/s air flow	30.0	°C/W
θ_{JA}	1 linear m/s air flow	27.5	°C/W
θ_{JA}	2 linear m/s air flow	26.5	°C/W
θ_{JC}		9.2	°C/W
Ψ_{JT}	0 linear m/s air flow	0.15	°C/W
Ψ_{JT}	1 linear m/s air flow	0.24	°C/W
Ψ_{JT}	2 linear m/s air flow	0.27	°C/W

ADSP-CM402F/CM403F/CM407F/CM408F/CM409F

Values of θ_{JA} are provided for package comparison and printed circuit board design considerations. θ_{JA} can be used for a first order approximation of T_J by the equation:

$$T_J = T_A + (\theta_{JA} \times P_D)$$

where:

T_A = Ambient temperature (°C).

Values of θ_{JC} are provided for package comparison and printed circuit board design considerations when an external heat sink is required.

In [Table 68](#) and [Table 69](#), airflow measurements comply with JEDEC standards JESD51-2 and JESD51-6. The junction-to-case measurement complies with MIL-STD-883 (Method 1012.1). All measurements use a 2S2P JEDEC test board.

ADSP-CM402F/CM403F/CM407F/CM408F/CM409F

ADSP-CM402F/ADSP-CM403F 120-LEAD LQFP LEAD ASSIGNMENTS

Table 71 lists the 120-lead LQFP package by lead number and

Table 72 lists the 120-lead LQFP package by pin name.

Table 71. ADSP-CM402F/ADSP-CM403F 120-Lead LQFP Lead Assignments (Numerical by Lead Number)

Lead No.	Pin Name	Lead No.	Pin Name	Lead No.	Pin Name	Lead No.	Pin Name
1	PA_13	32	JTG_TRST	63	ADC1_VIN05	94	DACO_VOUT
2	VDD_EXT	33	JTG_TDO/SWO	64	ADC1_VIN06	95	VDD_EXT
3	PA_12	34	JTG_TMS/SWDIO	65	ADC1_VIN07	96	VDD_INT
4	PA_11	35	PC_07	66	ADC1_VIN08	97	VDD_EXT
5	PA_10	36	VDD_EXT	67	ADC1_VIN09	98	GND
6	PA_09	37	PC_06	68	ADC1_VIN10	99	SYS_NMI
7	PA_08	38	PC_05	69	ADC1_VIN11	100	VDD_EXT
8	PA_07	39	PC_04	70	VDD_ANA1	101	VDD_EXT
9	VDD_EXT	40	PC_03	71	GND_ANA1	102	PB_10
10	PA_06	41	PC_02	72	BYP_A1	103	PB_08
11	PA_05	42	PC_01	73	VREF1	104	PB_09
12	PA_04	43	VDD_EXT	74	GND_VREF1	105	PB_06
13	PA_03	44	VDD_INT	75	REFCAP	106	PB_07
14	PA_02	45	PC_00	76	GND_VREF0	107	PB_05
15	PA_01	46	PB_14	77	VREF0	108	VDD_INT
16	VDD_INT	47	PB_15	78	BYP_A0	109	VDD_EXT
17	VDD_EXT	48	PB_13	79	GND_ANA0	110	PB_04
18	SYS_RESOUT	49	VDD_EXT	80	VDD_ANA0	111	PB_03
19	PA_00	50	PB_11	81	ADC0_VIN11	112	PB_02
20	SYS_FAULT	51	PB_12	82	ADC0_VIN10	113	PB_01
21	SYS_HWRST	52	GND	83	ADC0_VIN09	114	PB_00
22	VDD_EXT	53	VDD_EXT	84	ADC0_VIN08	115	PA_15
23	SYS_XTAL	54	VDD_INT	85	ADC0_VIN07	116	VDD_EXT
24	SYS_CLKIN	55	BYP_D0	86	ADC0_VIN06	117	PA_14
25	VREG_BASE	56	DAC1_VOUT	87	ADC0_VIN05	118	SYS_CLKOUT
26	VDD_VREG	57	ADC1_VIN00	88	ADC0_VIN04	119	SYS_BMODE1
27	VDD_EXT	58	ADC1_VIN01	89	ADC0_VIN03	120	SYS_BMODE0
28	TWI0_SCL	59	ADC1_VIN02	90	GND_ANA2	121	GND
29	TWI0_SDA	60	ADC1_VIN03	91	ADC0_VIN02		
30	JTG_TDI	61	GND_ANA3	92	ADC0_VIN01		
31	JTG_TCK/SWCLK	62	ADC1_VIN04	93	ADC0_VIN00		

* Pin no. 121 is the GND supply (see Figure 66) for the processor; this pad **must** connect to GND.

ADSP-CM402F/CM403F/CM407F/CM408F/CM409F

Table 72. ADSP-CM402F/ADSP-CM403F 120-Lead LQFP Lead Assignments (Alphabetical by Pin Name)

Pin Name	Lead No.	Pin Name	Lead No.	Pin Name	Lead No.	Pin Name	Lead No.
ADC0_VIN00	93	GND	121	PB_03	111	TWI0_SCL	28
ADC0_VIN01	92	GND_ANA0	79	PB_04	110	TWI0_SDA	29
ADC0_VIN02	91	GND_ANA1	71	PB_05	107	VDD_ANA0	80
ADC0_VIN03	89	GND_ANA2	90	PB_06	105	VDD_ANA1	70
ADC0_VIN04	88	GND_ANA3	61	PB_07	106	VDD_EXT	2
ADC0_VIN05	87	GND_VREF0	76	PB_08	103	VDD_EXT	9
ADC0_VIN06	86	GND_VREF1	74	PB_09	104	VDD_EXT	17
ADC0_VIN07	85	JTG_TCK/SWCLK	31	PB_10	102	VDD_EXT	22
ADC0_VIN08	84	JTG_TDI	30	PB_11	50	VDD_EXT	27
ADC0_VIN09	83	JTG_TDO/SWO	33	PB_12	51	VDD_EXT	36
ADC0_VIN10	82	JTG_TMS/SWDIO	34	PB_13	48	VDD_EXT	43
ADC0_VIN11	81	JTG_TRST	32	PB_14	46	VDD_EXT	49
ADC1_VIN00	57	PA_00	19	PB_15	47	VDD_EXT	53
ADC1_VIN01	58	PA_01	15	PC_00	45	VDD_EXT	95
ADC1_VIN02	59	PA_02	14	PC_01	42	VDD_EXT	97
ADC1_VIN03	60	PA_03	13	PC_02	41	VDD_EXT	100
ADC1_VIN04	62	PA_04	12	PC_03	40	VDD_EXT	101
ADC1_VIN05	63	PA_05	11	PC_04	39	VDD_EXT	109
ADC1_VIN06	64	PA_06	10	PC_05	38	VDD_EXT	116
ADC1_VIN07	65	PA_07	8	PC_06	37	VDD_INT	16
ADC1_VIN08	66	PA_08	7	PC_07	35	VDD_INT	44
ADC1_VIN09	67	PA_09	6	REFCAP	75	VDD_INT	54
ADC1_VIN10	68	PA_10	5	SYS_BMODE0	120	VDD_INT	96
ADC1_VIN11	69	PA_11	4	SYS_BMODE1	119	VDD_INT	108
BYP_A0	78	PA_12	3	SYS_CLKIN	24	VDD_VREG	26
BYP_A1	72	PA_13	1	SYS_CLKOUT	118	VREF0	77
BYP_D0	55	PA_14	117	SYS_FAULT	20	VREF1	73
DAC0_VOUT	94	PA_15	115	SYS_HWRST	21	VREG_BASE	25
DAC1_VOUT	56	PB_00	114	SYS_NMI	99		
GND	52	PB_01	113	SYS_RESOUT	18		
GND	98	PB_02	112	SYS_XTAL	23		

* Pin no. 121 is the GND supply (see [Figure 66](#)) for the processor; this pad **must** connect to GND.

ADSP-CM402F/CM403F/CM407F/CM408F/CM409F

Figure 65 shows the top view of the 120-lead LQFP package lead configuration and Figure 66 shows the bottom view of the 120-lead LQFP package lead configuration.

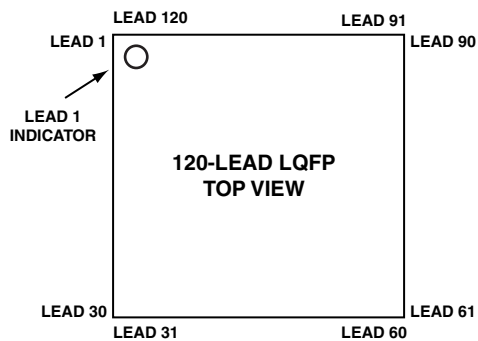

Figure 65. 120-Lead LQFP Lead Configuration (Top View)

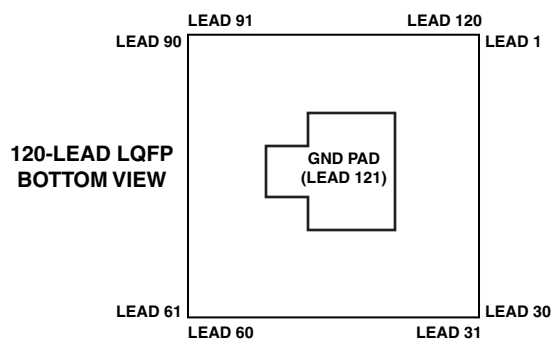

Figure 66. 120-Lead LQFP Lead Configuration (Bottom View)

ADSP-CM402F/CM403F/CM407F/CM408F/CM409F

ADSP-CM407F/ADSP-CM408F 176-LEAD LQFP LEAD ASSIGNMENTS

Table 73 lists the 176-lead LQFP package by lead number and

Table 74 lists the 176-lead LQFP package by pin name.

Table 73. ADSP-CM407F/ADSP-CM408F 176-Lead LQFP Lead Assignments (Numerical by Lead Number)

Lead No.	Pin Name	Lead No.	Pin Name	Lead No.	Pin Name	Lead No.	Pin Name
1	PA_13	46	JTG_TRST	91	PE_05	136	VDD_EXT
2	VDD_EXT	47	JTG_TDO/SWO	92	PE_04	137	VDD_EXT
3	PA_12	48	JTG_TMS/SWDIO	93	VDD_EXT	138	PD_12
4	PA_11	49	PC_07	94	VDD_INT	139	PD_13
5	PC_15	50	VDD_EXT	95	BYP_D0	140	PD_10
6	PA_10	51	PC_05	96	GND_ANA3	141	PD_11
7	PC_14	52	PC_06	97	ADC1_VIN00	142	PD_08
8	VDD_EXT	53	PF_10	98	ADC1_VIN01	143	PD_09
9	PC_13	54	PC_04	99	ADC1_VIN02	144	VDD_EXT
10	PC_11	55	PF_08	100	ADC1_VIN03	145	PD_07
11	PC_12	56	PF_09	101	ADC1_VIN04	146	PD_06
12	PA_09	57	VDD_EXT	102	ADC1_VIN05	147	SMCO_AMS0
13	PA_08	58	PF_06	103	ADC1_VIN06	148	SMCO_AWE
14	PA_07	59	PF_07	104	ADC1_VIN07	149	SMCO_ARE
15	VDD_EXT	60	PC_03	105	VDD_ANA1	150	VDD_EXT
16	PA_06	61	PF_05	106	GND_ANA1	151	PB_10
17	PA_05	62	PC_01	107	BYP_A1	152	PB_09
18	PA_04	63	PC_02	108	VREF1	153	PB_08
19	PA_03	64	VDD_EXT	109	GND_VREF1	154	PB_07
20	PA_02	65	VDD_INT	110	REFCAP	155	PB_06
21	PA_01	66	PC_00	111	GND_VREF0	156	PB_05
22	VDD_INT	67	PF_04	112	VREF0	157	VDD_INT
23	VDD_EXT	68	PF_03	113	BYP_A0	158	VDD_EXT
24	SYS_RESOUT	69	PF_02	114	GND_ANA0	159	PB_03
25	PA_00	70	PF_01	115	VDD_ANA0	160	PB_04
26	SYS_FAULT	71	PF_00	116	ADC0_VIN07	161	PD_05
27	SYS_HWRST	72	VDD_EXT	117	ADC0_VIN06	162	PB_02
28	VDD_EXT	73	PE_15	118	ADC0_VIN05	163	PD_03
29	SYS_XTAL	74	PE_14	119	ADC0_VIN04	164	PD_04

* Pin no. 177 is the GND supply (see Figure 68) for the processor; this pad **must** connect to GND.

ADSP-CM402F/CM403F/CM407F/CM408F/CM409F

Table 73. ADSP-CM407F/ADSP-CM408F 176-Lead LQFP Lead Assignments (Numerical by Lead Number) (Continued)

Lead No.	Pin Name	Lead No.	Pin Name	Lead No.	Pin Name	Lead No.	Pin Name
30	SYS_CLKIN	75	PE_13	120	ADC0_VIN03	165	VDD_EXT
31	VREG_BASE	76	PB_14	121	ADC0_VIN02	166	PD_01
32	VDD_VREG	77	PB_15	122	ADC0_VIN01	167	PD_02
33	VDD_EXT	78	PB_13	123	ADC0_VIN00	168	PB_01
34	USB0_DM	79	VDD_EXT	124	GND_ANA2	169	PD_00
35	USB0_DP	80	PB_11	125	VDD_EXT	170	PA_15
36	USB0_VBUS	81	PB_12	126	PE_03	171	PB_00
37	USB0_ID	82	PE_12	127	PE_02	172	VDD_EXT
38	PC_10	83	GND	128	VDD_INT	173	PA_14
39	PC_08	84	PE_11	129	VDD_EXT	174	SYS_CLKOUT
40	PC_09	85	PE_10	130	PE_01	175	SYS_BMODE1
41	VDD_EXT	86	VDD_EXT	131	GND	176	SYS_BMODE0
42	TWI0_SCL	87	PE_09	132	SYS_NMI	177	GND
43	TWI0_SDA	88	PE_08	133	PE_00		
44	JTG_TDI	89	PE_07	134	PD_15		
45	JTG_TCK/SWCLK	90	PE_06	135	PD_14		

* Pin no. 177 is the GND supply (see [Figure 68](#)) for the processor; this pad **must** connect to GND.

Table 74. ADSP-CM407F/ADSP-CM408F 176-Lead LQFP Lead Assignments (Alphabetical by Pin Name)

Pin Name	Lead No.	Pin Name	Lead No.	Pin Name	Lead No.	Pin Name	Lead No.
ADC0_VIN00	123	PA_12	3	PD_09	143	SYS_RESOUT	24
ADC0_VIN01	122	PA_13	1	PD_10	140	SYS_XTAL	29
ADC0_VIN02	121	PA_14	173	PD_11	141	TWI0_SCL	42
ADC0_VIN03	120	PA_15	170	PD_12	138	TWI0_SDA	43
ADC0_VIN04	119	PB_00	171	PD_13	139	USB0_DM	34
ADC0_VIN05	118	PB_01	168	PD_14	135	USB0_DP	35
ADC0_VIN06	117	PB_02	162	PD_15	134	USB0_ID	37
ADC0_VIN07	116	PB_03	159	PE_00	133	USB0_VBUS	36
ADC1_VIN00	97	PB_04	160	PE_01	130	VDD_ANA0	115
ADC1_VIN01	98	PB_05	156	PE_02	127	VDD_ANA1	105
ADC1_VIN02	99	PB_06	155	PE_03	126	VDD_EXT	2
ADC1_VIN03	100	PB_07	154	PE_04	92	VDD_EXT	8
ADC1_VIN04	101	PB_08	153	PE_05	91	VDD_EXT	15
ADC1_VIN05	102	PB_09	152	PE_06	90	VDD_EXT	23
ADC1_VIN06	103	PB_10	151	PE_07	89	VDD_EXT	28
ADC1_VIN07	104	PB_11	80	PE_08	88	VDD_EXT	33
BYP_A0	113	PB_12	81	PE_09	87	VDD_EXT	41
BYP_A1	107	PB_13	78	PE_10	85	VDD_EXT	50
BYP_D0	95	PB_14	76	PE_11	84	VDD_EXT	57
GND	83	PB_15	77	PE_12	82	VDD_EXT	64
GND	131	PC_00	66	PE_13	75	VDD_EXT	72
GND	177	PC_01	62	PE_14	74	VDD_EXT	79
GND_ANA0	114	PC_02	63	PE_15	73	VDD_EXT	86
GND_ANA1	106	PC_03	60	PF_00	71	VDD_EXT	93

* Pin no. 177 is the GND supply (see [Figure 68](#)) for the processor; this pad **must** connect to GND.

ADSP-CM402F/CM403F/CM407F/CM408F/CM409F

Table 74. ADSP-CM407F/ADSP-CM408F 176-Lead LQFP Lead Assignments (Alphabetical by Pin Name) (Continued)

Pin Name	Lead No.	Pin Name	Lead No.	Pin Name	Lead No.	Pin Name	Lead No.
GND_ANA2	124	PC_04	54	PF_01	70	VDD_EXT	125
GND_ANA3	96	PC_05	51	PF_02	69	VDD_EXT	129
GND_VREF0	111	PC_06	52	PF_03	68	VDD_EXT	136
GND_VREF1	109	PC_07	49	PF_04	67	VDD_EXT	137
JTG_TCK/SWCLK	45	PC_08	39	PF_05	61	VDD_EXT	144
JTG_TDI	44	PC_09	40	PF_06	58	VDD_EXT	150
JTG_TDO/SWO	47	PC_10	38	PF_07	59	VDD_EXT	158
JTG_TMS/SWDIO	48	PC_11	10	PF_08	55	VDD_EXT	165
$\overline{\text{JTG_TRST}}$	46	PC_12	11	PF_09	56	VDD_EXT	172
PA_00	25	PC_13	9	PF_10	53	VDD_INT	22
PA_01	21	PC_14	7	REFCAP	110	VDD_INT	65
PA_02	20	PC_15	5	$\overline{\text{SMCO_AMS0}}$	147	VDD_INT	94
PA_03	19	PD_00	169	$\overline{\text{SMCO_ARE}}$	149	VDD_INT	128
PA_04	18	PD_01	166	$\overline{\text{SMCO_AWE}}$	148	VDD_INT	157
PA_05	17	PD_02	167	SYS_BMODE0	176	VDD_VREG	32
PA_06	16	PD_03	163	SYS_BMODE1	175	VREF0	112
PA_07	14	PD_04	164	SYS_CLKIN	30	VREF1	108
PA_08	13	PD_05	161	SYS_CLKOUT	174	VREG_BASE	31
PA_09	12	PD_06	146	$\overline{\text{SYS_FAULT}}$	26		
PA_10	6	PD_07	145	$\overline{\text{SYS_HWRST}}$	27		
PA_11	4	PD_08	142	$\overline{\text{SYS_NMI}}$	132		

* Pin no. 177 is the GND supply (see [Figure 68](#)) for the processor; this pad **must** connect to GND.

ADSP-CM402F/CM403F/CM407F/CM408F/CM409F

Figure 67 shows the top view of the 176-lead LQFP lead configuration and Figure 68 shows the bottom view of the 176-lead LQFP lead configuration.

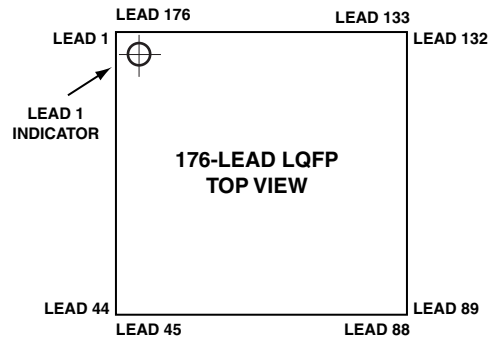

Figure 67. 176-Lead LQFP Lead Configuration (Top View)

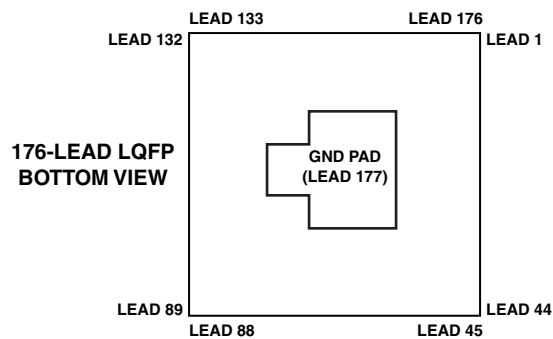

Figure 68. 176-Lead LQFP Lead Configuration (Bottom View)

ADSP-CM402F/CM403F/CM407F/CM408F/CM409F

ADSP-CM409F 212-BALL BGA BALL ASSIGNMENTS

Table 75 lists the 212-ball BGA package by ball number and

Table 76 lists the 212-ball BGA package by ball name.

Table 75. ADSP-CM409F 212-Ball BGA Ball Assignments (Numerical by Ball Number)

Ball No.	Ball Name	Ball No.	Ball Name	Ball No.	Ball Name	Ball No.	Ball Name
A01	GND	D01	PA_10	K03	VREG_BASE	T05	VDD_EXT
A02	PA_14	D02	PA_11	K07	GND	T06	PF_06
A03	PB_00	D03	PA_13	K08	GND	T07	PF_05
A04	PD_00	D07	VDD_INT	K09	GND	T08	PC_01
A05	PD_02	D08	VDD_EXT	K11	GND_ANA	T09	PF_02
A06	PD_03	D09	VDD_EXT	K12	GND_ANA	T10	PE_15
A07	PB_03	D10	VDD_EXT	K16	REFCAP	T11	PB_15
A08	PB_06	D11	VDD_EXT	K17	GND_ANA	T12	PB_11
A09	PB_09	D12	VDD_INT	K18	VDD_ANA1	T13	PE_11
A10	SMCO_AMS0	D16	DAC0_VOUT	L01	SYS_FAULT	T14	VDD_EXT
A11	SMCO_AWE	D17	ADC0_VIN03	L02	SYS_RESOUT	T15	VDD_EXT
A12	PD_08	D18	ADC0_VIN04	L03	VDD_EXT	T16	GND_ANA
A13	PD_10	E01	PC_14	L07	GND	T17	ADC1_VIN01
A14	PD_14	E02	PC_13	L08	GND	T18	ADC1_VIN03
A15	PE_00	E03	PA_12	L09	GND	U01	JTG_TRST
A16	PE_02	E16	BYP_A0	L11	GND_ANA	U02	GND
A17	PE_03	E17	ADC0_VIN05	L12	GND_ANA	U03	JTG_TDO/SWO
A18	GND_ANA	E18	ADC0_VIN06	L16	VREF1	U04	PC_05
B01	SYS_BMODE1	F01	PA_09	L17	ADC1_VIN11	U05	PF_10
B02	GND	F02	PC_12	L18	GND_ANA	U06	PF_09
B03	SYS_CLKOUT	F03	PC_11	M01	SYS_XTAL	U07	PC_03
B04	PA_15	F16	GND_ANA	M02	SYS_CLKIN	U08	PC_02
B05	PB_01	F17	ADC0_VIN07	M03	PA_00	U09	PF_03
B06	PD_04	F18	ADC0_VIN08	M16	GND_VREF1	U10	PF_00
B07	PB_02	G01	PA_07	M17	ADC1_VIN10	U11	PE_14
B08	PB_05	G02	PA_06	M18	ADC1_VIN09	U12	PB_13
B09	PB_08	G03	PA_08	N01	USB0_DM	U13	PB_12
B10	SMCO_ARE	G16	GND_VREF0	N02	USB0_VBUS	U14	PE_09
B11	PD_07	G17	ADC0_VIN10	N03	PC_10	U15	PE_08
B12	PD_11	G18	ADC0_VIN09	N16	GND_ANA	U16	PE_06
B13	PD_12	H01	PA_05	N17	ADC1_VIN07	U17	GND_ANA
B14	PD_15	H02	PA_04	N18	ADC1_VIN08	U18	ADC1_VIN00
B15	SYS_NMI	H03	VDD_INT	P01	USB0_DP	V01	GND
B16	PE_01	H07	GND	P02	USB0_ID	V02	JTG_TMS/SWDIO
B17	GND_ANA	H08	GND	P03	PC_08	V03	PC_07
B18	ADC0_VIN00	H09	GND	P16	BYP_A1	V04	PC_06
C01	PC_15	H11	GND_ANA	P17	ADC1_VIN05	V05	PC_04
C02	SYS_BMODE0	H12	GND_ANA	P18	ADC1_VIN06	V06	PF_08
C03	GND	H16	VREF0	R01	TWIO_SDA	V07	PF_07
C04	VDD_EXT	H17	ADC0_VIN11	R02	TWIO_SCL	V08	PC_00
C05	VDD_EXT	H18	GND_ANA	R03	PC_09	V09	PF_04
C06	PD_01	J01	PA_03	R07	VDD_EXT	V10	PF_01

ADSP-CM402F/CM403F/CM407F/CM408F/CM409F

Table 75. ADSP-CM409F 212-Ball BGA Ball Assignments (Numerical by Ball Number) (Continued)

Ball No.	Ball Name	Ball No.	Ball Name	Ball No.	Ball Name	Ball No.	Ball Name
C07	PD_05	J02	PA_02	R08	VDD_INT	V11	PE_13
C08	PB_04	J03	VDD_VREG	R09	VDD_EXT	V12	PB_14
C09	PB_07	J07	GND	R10	VDD_INT	V13	PE_12
C10	PB_10	J08	GND	R11	GND	V14	PE_10
C11	PD_06	J09	GND	R12	BYP_D0	V15	PE_07
C12	PD_09	J11	GND_ANA	R16	DAC1_VOUT	V16	PE_05
C13	PD_13	J12	GND_ANA	R17	ADC1_VIN02	V17	PE_04
C14	GND	J16	GND_ANA	R18	ADC1_VIN04	V18	GND_ANA
C15	VDD_EXT	J17	GND_ANA	T01	JTG_TDI		
C16	GND_ANA	J18	VDD_ANA0	T02	JTG_TCK/SWCLK		
C17	ADC0_VIN01	K01	PA_01	T03	GND		
C18	ADC0_VIN02	K02	SYS_HWRST	T04	VDD_EXT		

Table 76. ADSP-CM409F 212-Ball BGA Ball Assignments (Alphabetical by Ball Name)

Ball Name	Ball No.	Ball Name	Ball No.	Ball Name	Ball No.	Ball Name	Ball No.
ADC0_VIN00	B18	GND_ANA	H12	PB_15	T11	PF_05	T07
ADC0_VIN01	C17	GND_ANA	H18	PC_00	V08	PF_06	T06
ADC0_VIN02	C18	GND_ANA	J11	PC_01	T08	PF_07	V07
ADC0_VIN03	D17	GND_ANA	J12	PC_02	U08	PF_08	V06
ADC0_VIN04	D18	GND_ANA	J16	PC_03	U07	PF_09	U06
ADC0_VIN05	E17	GND_ANA	J17	PC_04	V05	PF_10	U05
ADC0_VIN06	E18	GND_ANA	K11	PC_05	U04	REFCAP	K16
ADC0_VIN07	F17	GND_ANA	K12	PC_06	V04	SMCO_AMS0	A10
ADC0_VIN08	F18	GND_ANA	K17	PC_07	V03	SMCO_ARE	B10
ADC0_VIN09	G18	GND_ANA	L11	PC_08	P03	SMCO_AWE	A11
ADC0_VIN10	G17	GND_ANA	L12	PC_09	R03	SYS_BMODE0	C02
ADC0_VIN11	H17	GND_ANA	L18	PC_10	N03	SYS_BMODE1	B01
ADC1_VIN00	U18	GND_ANA	N16	PC_11	F03	SYS_CLKIN	M02
ADC1_VIN01	T17	GND_ANA	T16	PC_12	F02	SYS_CLKOUT	B03
ADC1_VIN02	R17	GND_ANA	U17	PC_13	E02	SYS_FAULT	L01
ADC1_VIN03	T18	GND_ANA	V18	PC_14	E01	SYS_HWRST	K02
ADC1_VIN04	R18	GND_VREF0	G16	PC_15	C01	SYS_NMI	B15
ADC1_VIN05	P17	GND_VREF1	M16	PD_00	A04	SYS_RESOUT	L02
ADC1_VIN06	P18	JTG_TCK/SWCLK	T02	PD_01	C06	SYS_XTAL	M01
ADC1_VIN07	N17	JTG_TDI	T01	PD_02	A05	TW10_SCL	R02
ADC1_VIN08	N18	JTG_TDO/SWO	U03	PD_03	A06	TW10_SDA	R01
ADC1_VIN09	M18	JTG_TMS/SWDIO	V02	PD_04	B06	USB0_DM	N01
ADC1_VIN10	M17	JTG_TRST	U01	PD_05	C07	USB0_DP	P01
ADC1_VIN11	L17	PA_00	M03	PD_06	C11	USB0_ID	P02
BYP_A0	E16	PA_01	K01	PD_07	B11	USB0_VBUS	N02
BYP_A1	P16	PA_02	J02	PD_08	A12	VDD_ANA0	J18
BYP_D0	R12	PA_03	J01	PD_09	C12	VDD_ANA1	K18
DAC0_VOUT	D16	PA_04	H02	PD_10	A13	VDD_EXT	C04
DAC1_VOUT	R16	PA_05	H01	PD_11	B12	VDD_EXT	C05
GND	A01	PA_06	G02	PD_12	B13	VDD_EXT	C15

ADSP-CM402F/CM403F/CM407F/CM408F/CM409F

Table 76. ADSP-CM409F 212-Ball BGA Ball Assignments (Alphabetical by Ball Name) (Continued)

Ball Name	Ball No.	Ball Name	Ball No.	Ball Name	Ball No.	Ball Name	Ball No.
GND	B02	PA_07	G01	PD_13	C13	VDD_EXT	D08
GND	C03	PA_08	G03	PD_14	A14	VDD_EXT	D09
GND	C14	PA_09	F01	PD_15	B14	VDD_EXT	D10
GND	H07	PA_10	D01	PE_00	A15	VDD_EXT	D11
GND	H08	PA_11	D02	PE_01	B16	VDD_EXT	L03
GND	H09	PA_12	E03	PE_02	A16	VDD_EXT	R07
GND	J07	PA_13	D03	PE_03	A17	VDD_EXT	R09
GND	J08	PA_14	A02	PE_04	V17	VDD_EXT	T04
GND	J09	PA_15	B04	PE_05	V16	VDD_EXT	T05
GND	K07	PB_00	A03	PE_06	U16	VDD_EXT	T14
GND	K08	PB_01	B05	PE_07	V15	VDD_EXT	T15
GND	K09	PB_02	B07	PE_08	U15	VDD_INT	D07
GND	L07	PB_03	A07	PE_09	U14	VDD_INT	D12
GND	L08	PB_04	C08	PE_10	V14	VDD_INT	H03
GND	L09	PB_05	B08	PE_11	T13	VDD_INT	R08
GND	R11	PB_06	A08	PE_12	V13	VDD_INT	R10
GND	T03	PB_07	C09	PE_13	V11	VDD_VREG	J03
GND	U02	PB_08	B09	PE_14	U11	VREF0	H16
GND	V01	PB_09	A09	PE_15	T10	VREF1	L16
GND_ANA	A18	PB_10	C10	PF_00	U10	VREG_BASE	K03
GND_ANA	B17	PB_11	T12	PF_01	V10		
GND_ANA	C16	PB_12	U13	PF_02	T09		
GND_ANA	F16	PB_13	U12	PF_03	U09		
GND_ANA	H11	PB_14	V12	PF_04	V09		

ADSP-CM402F/CM403F/CM407F/CM408F/CM409F

Figure 69 shows an overview of signal placement on the 212-ball CSP_BGA package.

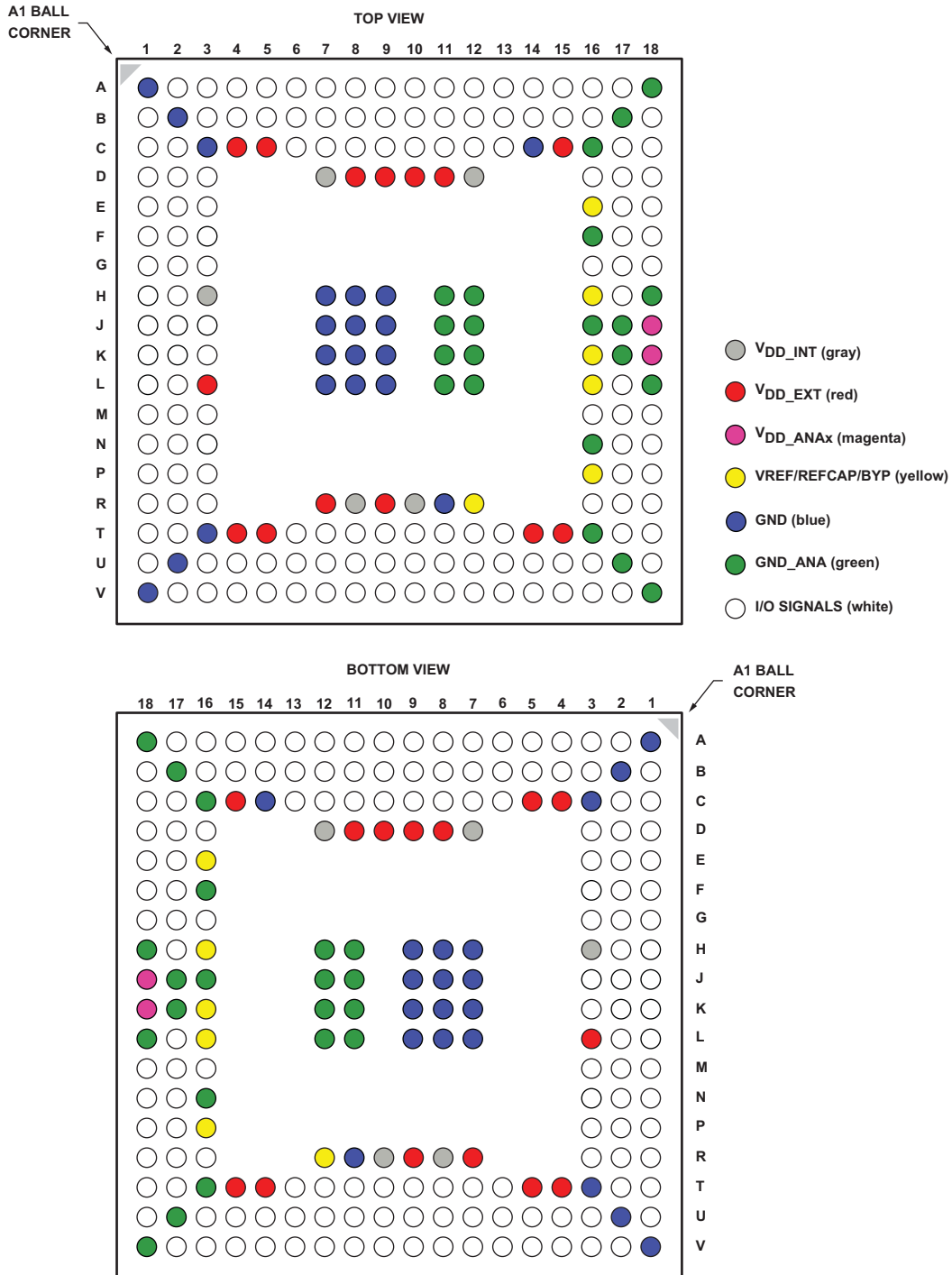

Figure 69. 212-Ball CSP_BGA Ball Configuration

ADSP-CM402F/CM403F/CM407F/CM408F/CM409F

OUTLINE DIMENSIONS

Dimensions in [Figure 70](#) (for the 120-lead LQFP), [Figure 71](#) (for the 176-lead LQFP) and [Figure 72](#) (for the 212-ball BGA) are shown in millimeters.

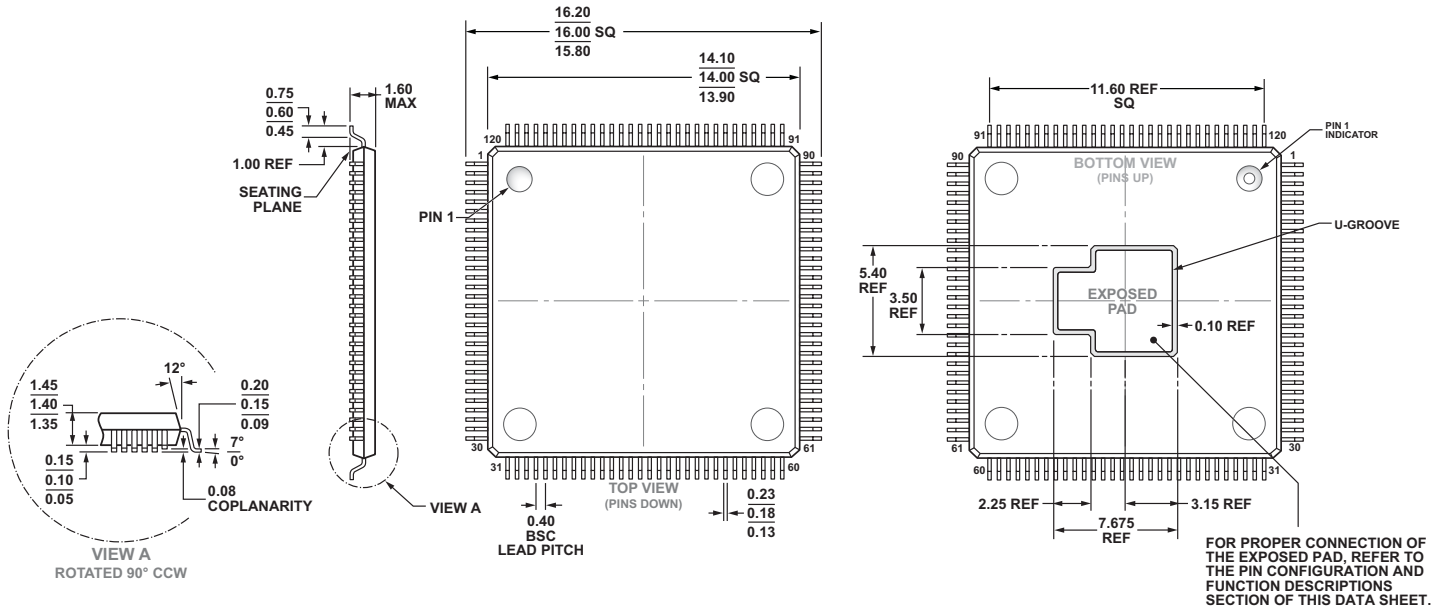

Figure 70. 120-Lead Low Profile Quad Flat Package, Exposed Pad [LQFP_EP]¹
(SW-120-3)

Dimensions shown in millimeters

¹ For information relating to the SW-120-3 package's exposed pad, see the table endnote in [ADSP-CM402F/ADSP-CM403F 120-Lead LQFP Lead Assignments on Page 110](#).

ADSP-CM402F/CM403F/CM407F/CM408F/CM409F

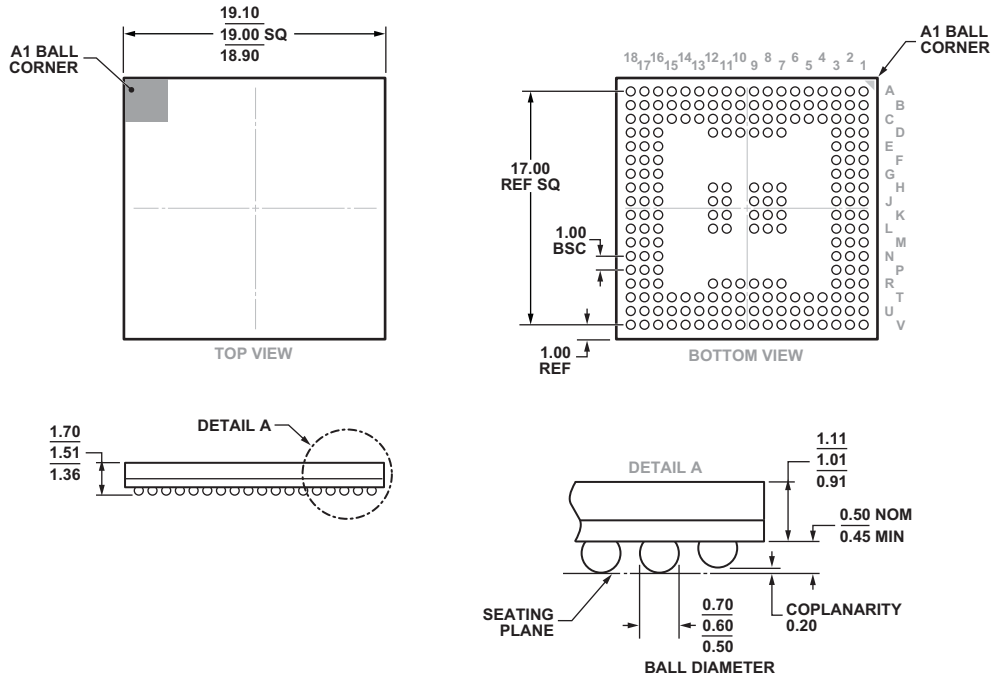

Figure 71. 176-Lead Low Profile Quad Flat Package, Exposed Pad [LQFP_EP]¹
 (SW-176-3)

Dimensions shown in millimeters

¹ For information relating to the SW-176-3 package's exposed pad, see the table endnote in [ADSP-CM407F/ADSP-CM408F 176-Lead LQFP Lead Assignments on Page 113](#).

ADSP-CM402F/CM403F/CM407F/CM408F/CM409F



COMPLIANT TO JEDEC STANDARDS MO-192-AAG-2
WITH EXCEPTION OF THE BALL COUNT.

Figure 72. 212-Ball Chip Scale Package Ball Grid Array [CSP_BGA]
(BC-212-1)

Dimensions shown in millimeters

ADSP-CM402F/CM403F/CM407F/CM408F/CM409F

ORDERING GUIDE

Model ¹	Max. Core Clock	ADC ENOB	Ethernet	Temperature Range ²	Package Description	Package Option
ADSP-CM402CSWZ-EF	150 MHz	11+	N/A	-40°C to +105°C	120-Lead Low Profile Quad Flat Package, Exposed Pad	SW-120-3
ADSP-CM402CSWZ-FF	100 MHz	11+	N/A	-40°C to +105°C	120-Lead Low Profile Quad Flat Package, Exposed Pad	SW-120-3
ADSP-CM403CSWZ-CF	240 MHz	13+	N/A	-40°C to +105°C	120-Lead Low Profile Quad Flat Package, Exposed Pad	SW-120-3
ADSP-CM403CSWZ-EF	150 MHz	13+	N/A	-40°C to +105°C	120-Lead Low Profile Quad Flat Package, Exposed Pad	SW-120-3
ADSP-CM403CSWZ-FF	100 MHz	13+	N/A	-40°C to +105°C	120-Lead Low Profile Quad Flat Package, Exposed Pad	SW-120-3
ADSP-CM407CSWZ-AF	240 MHz	11+	1	-40°C to +105°C	176-Lead Low Profile Quad Flat Package, Exposed Pad	SW-176-3
ADSP-CM407CSWZ-BF	240 MHz	11+	N/A	-40°C to +105°C	176-Lead Low Profile Quad Flat Package, Exposed Pad	SW-176-3
ADSP-CM407CSWZ-DF	150 MHz	11+	N/A	-40°C to +105°C	176-Lead Low Profile Quad Flat Package, Exposed Pad	SW-176-3
ADSP-CM408CSWZ-AF	240 MHz	13+	1	-40°C to +105°C	176-Lead Low Profile Quad Flat Package, Exposed Pad	SW-176-3
ADSP-CM408CSWZ-BF	240 MHz	13+	N/A	-40°C to +105°C	176-Lead Low Profile Quad Flat Package, Exposed Pad	SW-176-3
ADSP-CM409CBCZ-AF	240 MHz	13+	1	-40°C to +105°C	212-Ball Chip Scale Package Ball Grid Array	BC-212-1

¹Z = RoHS Compliant Part.

²Referenced temperature is ambient temperature. The ambient temperature is not a specification. See [Operating Conditions on Page 64](#) for the junction temperature (T_j) specification which is the only temperature specification.

Данный компонент на территории Российской Федерации

Вы можете приобрести в компании MosChip.

Для оперативного оформления запроса Вам необходимо перейти по данной ссылке:

<http://moschip.ru/get-element>

Вы можете разместить у нас заказ для любого Вашего проекта, будь то серийное производство или разработка единичного прибора.

В нашем ассортименте представлены ведущие мировые производители активных и пассивных электронных компонентов.

Нашей специализацией является поставка электронной компонентной базы двойного назначения, продукции таких производителей как XILINX, Intel (ex.ALTERA), Vicor, Microchip, Texas Instruments, Analog Devices, Mini-Circuits, Amphenol, Glenair.

Сотрудничество с глобальными дистрибьюторами электронных компонентов, предоставляет возможность заказывать и получать с международных складов практически любой перечень компонентов в оптимальные для Вас сроки.

На всех этапах разработки и производства наши партнеры могут получить квалифицированную поддержку опытных инженеров.

Система менеджмента качества компании отвечает требованиям в соответствии с ГОСТ Р ИСО 9001, ГОСТ РВ 0015-002 и ЭС РД 009

Офис по работе с юридическими лицами:

105318, г.Москва, ул.Щербаковская д.3, офис 1107, 1118, ДЦ «Щербаковский»

Телефон: +7 495 668-12-70 (многоканальный)

Факс: +7 495 668-12-70 (доб.304)

E-mail: info@moschip.ru

Skype отдела продаж:

moschip.ru

moschip.ru_4

moschip.ru_6

moschip.ru_9