



Is Now Part of



**ON Semiconductor®**

To learn more about ON Semiconductor, please visit our website at  
[www.onsemi.com](http://www.onsemi.com)

Please note: As part of the Fairchild Semiconductor integration, some of the Fairchild orderable part numbers will need to change in order to meet ON Semiconductor's system requirements. Since the ON Semiconductor product management systems do not have the ability to manage part nomenclature that utilizes an underscore (\_), the underscore (\_) in the Fairchild part numbers will be changed to a dash (-). This document may contain device numbers with an underscore (\_). Please check the ON Semiconductor website to verify the updated device numbers. The most current and up-to-date ordering information can be found at [www.onsemi.com](http://www.onsemi.com). Please email any questions regarding the system integration to [Fairchild\\_questions@onsemi.com](mailto:Fairchild_questions@onsemi.com).

ON Semiconductor and the ON Semiconductor logo are trademarks of Semiconductor Components Industries, LLC dba ON Semiconductor or its subsidiaries in the United States and/or other countries. ON Semiconductor owns the rights to a number of patents, trademarks, copyrights, trade secrets, and other intellectual property. A listing of ON Semiconductor's product/patent coverage may be accessed at [www.onsemi.com/site/pdf/Patent-Marking.pdf](http://www.onsemi.com/site/pdf/Patent-Marking.pdf). ON Semiconductor reserves the right to make changes without further notice to any products herein. ON Semiconductor makes no warranty, representation or guarantee regarding the suitability of its products for any particular purpose, nor does ON Semiconductor assume any liability arising out of the application or use of any product or circuit, and specifically disclaims any and all liability, including without limitation special, consequential or incidental damages. Buyer is responsible for its products and applications using ON Semiconductor products, including compliance with all laws, regulations and safety requirements or standards, regardless of any support or applications information provided by ON Semiconductor. "Typical" parameters which may be provided in ON Semiconductor data sheets and/or specifications can and do vary in different applications and actual performance may vary over time. All operating parameters, including "Typicals" must be validated for each customer application by customer's technical experts. ON Semiconductor does not convey any license under its patent rights nor the rights of others. ON Semiconductor products are not designed, intended, or authorized for use as a critical component in life support systems or any FDA Class 3 medical devices or medical devices with a same or similar classification in a foreign jurisdiction or any devices intended for implantation in the human body. Should Buyer purchase or use ON Semiconductor products for any such unintended or unauthorized application, Buyer shall indemnify and hold ON Semiconductor and its officers, employees, subsidiaries, affiliates, and distributors harmless against all claims, costs, damages, and expenses, and reasonable attorney fees arising out of, directly or indirectly, any claim of personal injury or death associated with such unintended or unauthorized use, even if such claim alleges that ON Semiconductor was negligent regarding the design or manufacture of the part. ON Semiconductor is an Equal Opportunity/Affirmative Action Employer. This literature is subject to all applicable copyright laws and is not for resale in any manner.



October 2014

# CNY171M, CNY172M, CNY173M, CNY174M, CNY17F1M, CNY17F2M, CNY17F3M, CNY17F4M, MOC8106M 6-Pin DIP High $BV_{CEO}$ Phototransistor Optocouplers

## Features

- High  $BV_{CEO}$ : 70 V Minimum (CNY17XM, CNY17FXM, MOC8106M)
- Closely Matched Current Transfer Ratio (CTR) Minimizes Unit-to-Unit Variation
- Current Transfer Ratio In Select Groups
- Very Low Coupled Capacitance Along With No Chip-to-Pin 6 Base Connection for Minimum Noise Susceptability (CNY17FXM, MOC8106M)
- Safety and Regulatory Approvals:
  - UL1577, 4,170  $VAC_{RMS}$  for 1 Minute
  - DIN-EN/IEC60747-5-5, 850 V Peak Working Insulation Voltage

## Applications

- Power Supply Regulators
- Digital Logic Inputs
- Microprocessor Inputs
- Appliance Sensor Systems
- Industrial Controls

## Description

The CNY17XM, CNY17FXM, and MOC8106M devices consist of a gallium arsenide infrared emitting diode coupled with an NPN phototransistor in a dual in-line package.

## Package Outlines

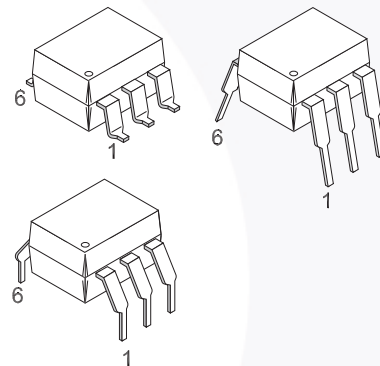

Figure 1. Package Outlines

## Schematics



Figure 2. Schematics

CNY17XM, CNY17FXM, MOC8106M — 6-Pin DIP High  $BV_{CEO}$  Phototransistor Optocouplers

## Safety and Insulation Ratings

As per DIN EN/IEC 60747-5-5, this optocoupler is suitable for “safe electrical insulation” only within the safety limit data. Compliance with the safety ratings shall be ensured by means of protective circuits.

| Parameter   |                        | Characteristics |
|---|------------------------|-----------------|
| Installation Classifications per DIN VDE 0110/1.89 Table 1, For Rated Mains Voltage | < 150 V <sub>RMS</sub> | I–IV            |
|   | < 300 V <sub>RMS</sub> | I–IV            |
| Climatic Classification   |                        | 55/100/21       |
| Pollution Degree (DIN VDE 0110/1.89)  |                        | 2               |
| Comparative Tracking Index  |                        | 175             |

| Symbol                | Parameter  | Value             | Unit              |
|-----------------------|--|-------------------|-------------------|
| V <sub>PR</sub>       | Input-to-Output Test Voltage, Method A, V <sub>IORM</sub> × 1.6 = V <sub>PR</sub> , Type and Sample Test with t <sub>m</sub> = 10 s, Partial Discharge < 5 pC  | 1360              | V <sub>peak</sub> |
|                       | Input-to-Output Test Voltage, Method B, V <sub>IORM</sub> × 1.875 = V <sub>PR</sub> , 100% Production Test with t <sub>m</sub> = 1 s, Partial Discharge < 5 pC | 1594              | V <sub>peak</sub> |
| V <sub>IORM</sub>     | Maximum Working Insulation Voltage   | 850               | V <sub>peak</sub> |
| V <sub>IOTM</sub>     | Highest Allowable Over-Voltage   | 6000              | V <sub>peak</sub> |
|                       | External Creepage  | ≥ 7               | mm                |
|                       | External Clearance   | ≥ 7               | mm                |
|                       | External Clearance (for Option TV, 0.4" Lead Spacing)  | ≥ 10              | mm                |
| DTI                   | Distance Through Insulation (Insulation Thickness)   | ≥ 0.5             | mm                |
| T <sub>S</sub>        | Case Temperature <sup>(1)</sup>  | 175               | °C                |
| I <sub>S,INPUT</sub>  | Input Current <sup>(1)</sup>   | 350               | mA                |
| P <sub>S,OUTPUT</sub> | Output Power <sup>(1)</sup>  | 800               | mW                |
| R <sub>IO</sub>       | Insulation Resistance at T <sub>S</sub> , V <sub>IO</sub> = 500 V <sup>(1)</sup>   | > 10 <sup>9</sup> | Ω                 |

### Note:

1. Safety limit values – maximum values allowed in the event of a failure.

## Absolute Maximum Ratings

Stresses exceeding the absolute maximum ratings may damage the device. The device may not function or be operable above the recommended operating conditions and stressing the parts to these levels is not recommended. In addition, extended exposure to stresses above the recommended operating conditions may affect device reliability. The absolute maximum ratings are stress ratings only.

| Symbol              | Parameters   | Value              | Units |
|---------------------|--|--------------------|-------|
| <b>TOTAL DEVICE</b> |  |                    |       |
| T <sub>STG</sub>    | Storage Temperature  | -40 to +125        | °C    |
| T <sub>A</sub>      | Ambient Operating Temperature  | -40 to +100        | °C    |
| T <sub>J</sub>      | Junction Temperature   | -40 to +125        | °C    |
| T <sub>SOL</sub>    | Lead Solder Temperature  | 260 for 10 seconds | °C    |
| P <sub>D</sub>      | Total Device Power Dissipation @ 25°C (LED plus detector)<br>Derate Linearly From 25°C | 270                | mW    |
|                     |  | 2.94               | mW/°C |
| <b>EMITTER</b>      |  |                    |       |
| I <sub>F</sub>      | Continuous Forward Current   | 60                 | mA    |
| V <sub>R</sub>      | Reverse Voltage  | 6                  | V     |
| I <sub>F</sub> (pk) | Forward Current – Peak (1 μs pulse, 300 pps)   | 1.5                | A     |
| P <sub>D</sub>      | LED Power Dissipation 25°C Ambient<br>Derate Linearly From 25°C                        | 120                | mW    |
|                     |  | 1.41               | mW/°C |
| <b>DETECTOR</b>     |  |                    |       |
| I <sub>C</sub>      | Continuous Collector Current   | 50                 | mA    |
| V <sub>CEO</sub>    | Collector-Emitter Voltage  | 70                 | V     |
| V <sub>ECO</sub>    | Emitter Collector Voltage  | 7                  | V     |
| P <sub>D</sub>      | Detector Power Dissipation @ 25°C<br>Derate Linearly from 25°C                         | 150                | mW    |
|                     |  | 1.76               | mW/°C |

## Electrical Characteristics

$T_A = 25^\circ\text{C}$  unless otherwise specified.

### Individual Component Characteristics

| Symbol          | Parameters                                | Test Conditions                         | Device            | Min. | Typ.  | Max. | Units         |
|-----------------|---|---|-------------------|------|-------|------|---------------|
| <b>EMITTER</b>  |   |   |                   |      |       |      |               |
| $V_F$           | Input Forward Voltage                     | $I_F = 10\text{ mA}$                    | All Devices       | 1.0  | 1.15  | 1.50 | V             |
|                 |   | $I_F = 60\text{ mA}$                    | CNY17XM, CNY17FXM | 1.0  | 1.35  | 1.65 | v             |
| $C_J$           | Capacitance                               | $V_F = 0\text{ V}, f = 1.0\text{ MHz}$  | All Devices       |      | 18    |      | pF            |
| $I_R$           | Reverse Leakage Current                   | $V_R = 6\text{ V}$                      | All Devices       |      | 0.001 | 10   | $\mu\text{A}$ |
| <b>DETECTOR</b> |   |   |                   |      |       |      |               |
| $BV_{CEO}$      | Breakdown Voltage<br>Collector-to-Emitter | $I_C = 1\text{ mA}, I_F = 0$            | All Devices       | 70   | 100   |      | V             |
|                 |   |   | CNY17XM           | 70   | 120   |      | V             |
| $BV_{CBO}$      | Collector-to-Base                         | $I_C = 10\text{ }\mu\text{A}, I_F = 0$  | CNY17XM           | 70   | 120   |      | V             |
| $BV_{ECO}$      | Emitter-to-Collector                      | $I_E = 100\text{ }\mu\text{A}, I_F = 0$ | All Devices       | 7    | 10    |      | V             |
| $I_{CEO}$       | Leakage Current<br>Collector-to-Emitter   | $V_{CE} = 10\text{ V}, I_F = 0$         | All Devices       |      | 1     | 50   | nA            |
|                 |   |   | CNY17XM           |      |       | 20   | nA            |
| $I_{CBO}$       | Collector-to-Base                         | $V_{CB} = 10\text{ V}, I_F = 0$         | CNY17XM           |      |       | 20   | nA            |
| $C_{CE}$        | Capacitance<br>Collector-to-Emitter       | $V_{CE} = 0, f = 1\text{ MHz}$          | All Devices       |      | 8     |      | pF            |
|                 |   |   | CNY17XM           |      | 20    |      | pF            |
|                 |   |   | CNY17XM           |      | 10    |      | pF            |
| $C_{CB}$        | Collector-to-Base                         | $V_{CB} = 0, f = 1\text{ MHz}$          | CNY17XM           |      | 20    |      | pF            |
| $C_{EB}$        | Emitter-to-Base                           | $V_{EB} = 0, f = 1\text{ MHz}$          | CNY17XM           |      | 10    |      | pF            |

### Transfer Characteristics

| Symbol         | Parameters                           | Test Conditions                            | Device            | Min. | Typ. | Max. | Units |
|----------------|--------------------------------------|--|-------------------|------|------|------|-------|
| <b>COUPLED</b> |                                      |  |                   |      |      |      |       |
| CTR            | Current Transfer Ratio               | $I_F = 10\text{ mA}, V_{CE} = 10\text{ V}$ | MOC8106M          | 50   |      | 150  | %     |
|                |                                      | $I_F = 10\text{ mA}, V_{CE} = 5\text{ V}$  | CNY171M, CNY17F1M | 40   |      | 80   | %     |
|                |                                      | $I_F = 10\text{ mA}, V_{CE} = 5\text{ V}$  | CNY172M, CNY17F2M | 63   |      | 125  | %     |
|                |                                      | $I_F = 10\text{ mA}, V_{CE} = 5\text{ V}$  | CNY173M, CNY17F3M | 100  |      | 200  | %     |
|                |                                      | $I_F = 10\text{ mA}, V_{CE} = 5\text{ V}$  | CNY174M, CNY17F4M | 160  |      | 320  | %     |
| $V_{CE(SAT)}$  | Collector-Emitter Saturation Voltage | $I_C = 0.5\text{ mA}, I_F = 5\text{ mA}$   | MOC8106M          |      |      | 0.4  | V     |
|                |                                      | $I_C = 2.5\text{ mA}, I_F = 10\text{ mA}$  | CNY17XM/CNY17FXM  |      |      | 0.4  | V     |

## Electrical Characteristics (Continued)

T<sub>A</sub> = 25°C unless otherwise specified.

### AC Characteristics

| Symbol                              | Parameters    | Test Conditions   | Device                            | Min. | Typ. | Max. | Units |
|-------------------------------------|---------------|---|-----------------------------------|------|------|------|-------|
| <b>NON-SATURATED SWITCHING TIME</b> |               |   |                                   |      |      |      |       |
| t <sub>on</sub>                     | Turn-On Time  | I <sub>C</sub> = 2.0 mA, V <sub>CC</sub> = 10 V, R <sub>L</sub> = 100 Ω | All Devices                       |      | 2.0  | 10.0 | μs    |
| t <sub>off</sub>                    | Turn-Off Time | I <sub>C</sub> = 2.0 mA, V <sub>CC</sub> = 10 V, R <sub>L</sub> = 100 Ω | All Devices                       |      | 3.0  | 10.0 | μs    |
| t <sub>d</sub>                      | Delay Time    | I <sub>F</sub> = 10 mA, V <sub>CC</sub> = 5 V, R <sub>L</sub> = 75 Ω    | CNY17XM/CNY17FXM                  |      |      | 5.6  | μs    |
| t <sub>r</sub>                      | Rise Time     | I <sub>F</sub> = 10 mA, V <sub>CC</sub> = 5 V, R <sub>L</sub> = 75 Ω    | CNY17XM/CNY17FXM                  |      |      | 4.0  | μs    |
| t <sub>s</sub>                      | Storage Time  | I <sub>F</sub> = 10 mA, V <sub>CC</sub> = 5 V, R <sub>L</sub> = 75 Ω    | CNY17XM/CNY17FXM                  |      |      | 4.1  | μs    |
| t <sub>f</sub>                      | Fall Time     | I <sub>F</sub> = 10 mA, V <sub>CC</sub> = 5 V, R <sub>L</sub> = 75 Ω    | CNY17XM/CNY17FXM                  |      |      | 3.5  | μs    |
| <b>SATURATED SWITCHING TIMES</b>    |               |   |                                   |      |      |      |       |
| t <sub>d</sub>                      | Delay Time    | I <sub>F</sub> = 20 mA, V <sub>CC</sub> = 5 V, R <sub>L</sub> = 1 kΩ    | CNY171M/F1M                       |      |      | 5.5  | μs    |
|                                     |               | I <sub>F</sub> = 10 mA, V <sub>CC</sub> = 5 V, R <sub>L</sub> = 1 kΩ    | CNY172M/3M/4M<br>CNY17F2M/F3M/F4M |      |      | 8.0  | μs    |
| t <sub>r</sub>                      | Rise Time     | I <sub>F</sub> = 20 mA, V <sub>CC</sub> = 5 V, R <sub>L</sub> = 1 kΩ    | CNY171M/F1M                       |      |      | 4.0  | μs    |
|                                     |               | I <sub>F</sub> = 10 mA, V <sub>CC</sub> = 5 V, R <sub>L</sub> = 1 kΩ    | CNY172M/3M/4M<br>CNY17F2M/F3M/F4M |      |      | 6.0  | μs    |
| t <sub>s</sub>                      | Storage Time  | I <sub>F</sub> = 20 mA, V <sub>CC</sub> = 5 V, R <sub>L</sub> = 1 kΩ    | CNY171M/F1M                       |      |      | 34.0 | μs    |
|                                     |               | I <sub>F</sub> = 10 mA, V <sub>CC</sub> = 5 V, R <sub>L</sub> = 1 kΩ    | CNY172M/3M/4M<br>CNY17F2M/F3M/F4M |      |      | 39.0 | μs    |
| t <sub>f</sub>                      | Fall Time     | I <sub>F</sub> = 20 mA, V <sub>CC</sub> = 5 V, R <sub>L</sub> = 1 kΩ    | CNY171M/F1M                       |      |      | 20.0 | μs    |
|                                     |               | I <sub>F</sub> = 10 mA, V <sub>CC</sub> = 5 V, R <sub>L</sub> = 1 kΩ    | CNY172M/3M/4M<br>CNY17F2M/F3M/F4M |      |      | 24.0 | μs    |

### Isolation Characteristics

| Symbol           | Characteristic                 | Test Conditions                                    | Min.             | Typ. | Max. | Units              |
|------------------|--------------------------------|--|------------------|------|------|--------------------|
| V <sub>ISO</sub> | Input-Output Isolation Voltage | t = 1 Minute                                       | 4170             |      |      | V <sub>ACRMS</sub> |
| C <sub>ISO</sub> | Isolation Capacitance          | V <sub>I-O</sub> = 0 V, f = 1 MHz                  |                  | 0.2  |      | pF                 |
| R <sub>ISO</sub> | Isolation Resistance           | V <sub>I-O</sub> = ±500 VDC, T <sub>A</sub> = 25°C | 10 <sup>11</sup> |      |      | Ω                  |

### Typical Performance Characteristics

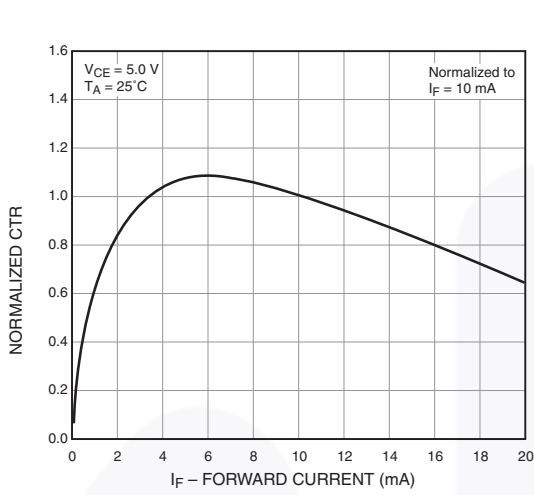

Figure 3. Normalized CTR vs. Forward Current

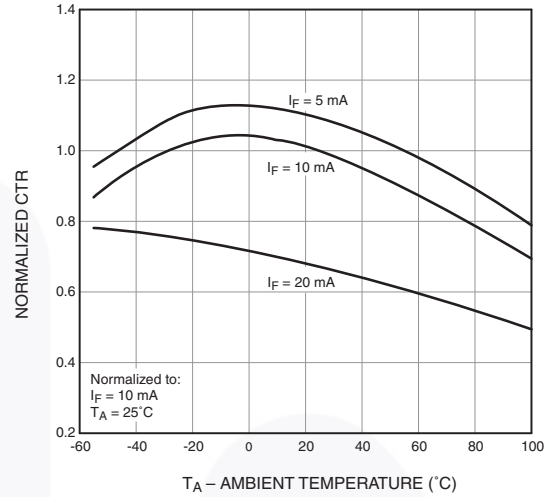

Figure 4. Normalized CTR vs. Ambient Temperature

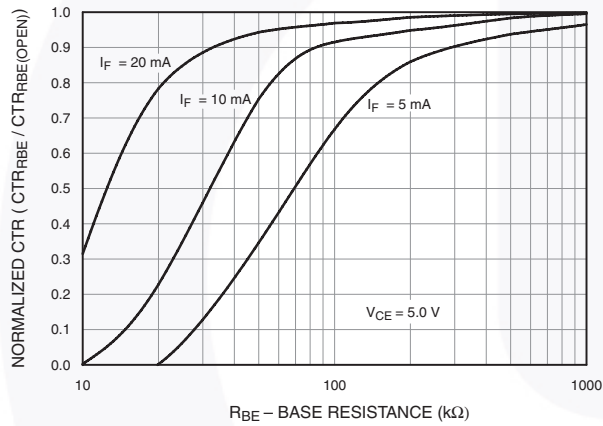

Figure 5. CTR vs. R<sub>BE</sub> (Unsaturated)

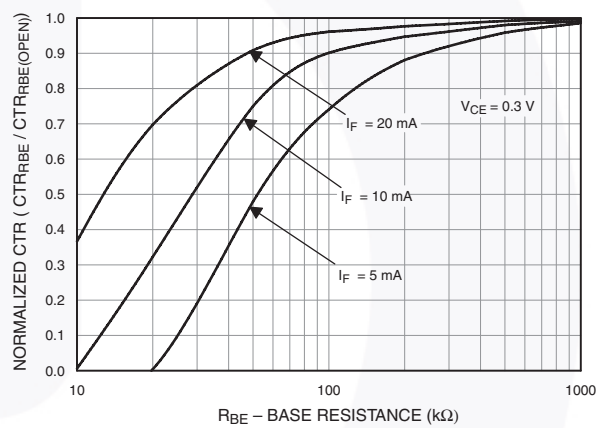

Figure 6. CTR vs. R<sub>BE</sub> (Saturated)

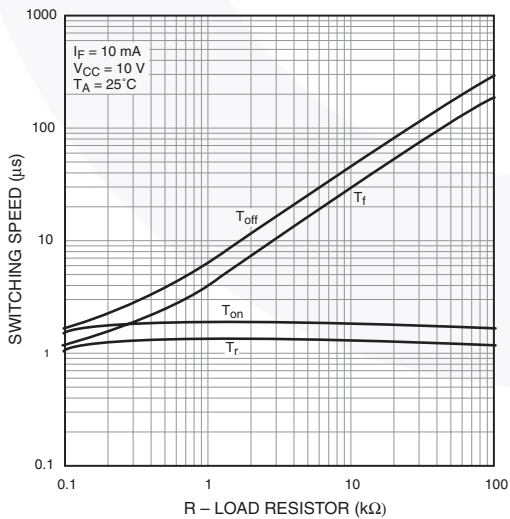

Figure 7. Switching Speed vs. Load Resistor

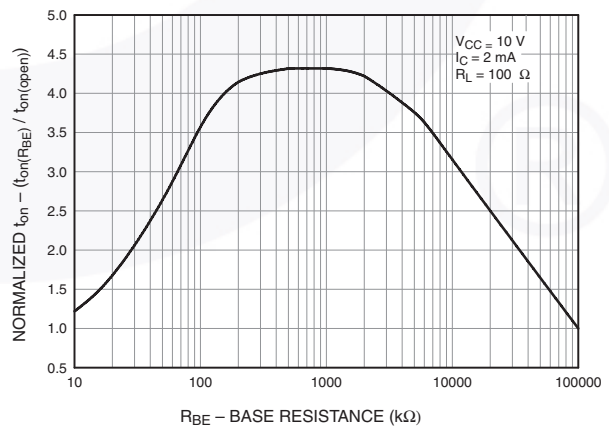

Figure 8. Normalized  $t_{on}$  vs. R<sub>BE</sub>

Typical Performance Characteristics (Continued)



Figure 9. Normalized  $t_{off}$  vs.  $R_{BE}$



Figure 10. LED Forward Voltage vs. Forward Current



Figure 11. Collector-Emitter Saturation Voltage vs. Collector Current



### Switching Test Circuit and Waveforms

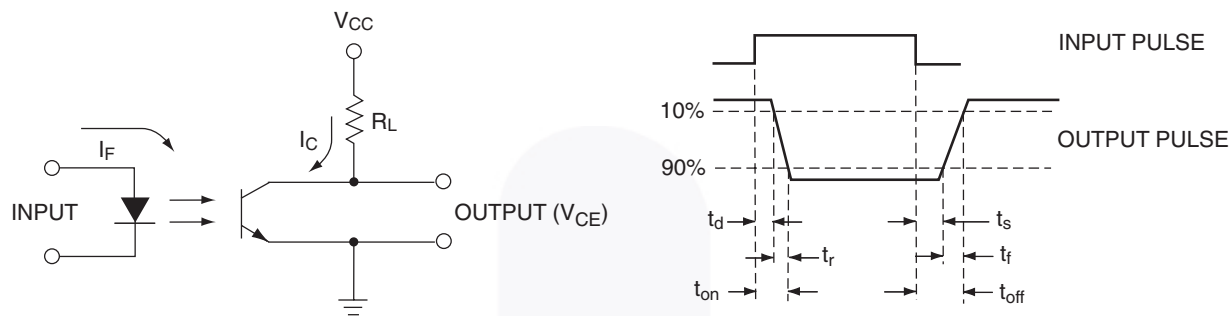

Figure 12. Switching Test Circuit and Waveforms

### Reflow Profile



Figure 13. Reflow Profile

## Ordering Information

| Part Number | Package  | Packing Method             |
|-------------|--|----------------------------|
| CNY171M     | DIP 6-Pin  | Tube (50 Units)            |
| CNY171SM    | SMT 6-Pin (Lead Bend)                                    | Tube (50 Units)            |
| CNY171SR2M  | SMT 6-Pin (Lead Bend)                                    | Tape and Reel (1000 Units) |
| CNY171TM    | DIP 6-Pin, 0.4" Lead Spacing                             | Tube (50 Units)            |
| CNY171VM    | DIP 6-Pin, DIN EN/IEC60747-5-5 Option                    | Tube (50 Units)            |
| CNY171SVM   | SMT 6-Pin (Lead Bend), DIN EN/IEC60747-5-5 Option        | Tube (50 Units)            |
| CNY171SR2VM | SMT 6-Pin (Lead Bend), DIN EN/IEC60747-5-5 Option        | Tape and Reel (1000 Units) |
| CNY171TVM   | DIP 6-Pin, 0.4" Lead Spacing, DIN EN/IEC60747-5-5 Option | Tube (50 Units)            |

**Note:**

2. The product orderable part number system listed in this table also applies to the CNY17FXM product family and the MOC8106M device.

## Marking Information



Figure 14. Top Mark

Table 1. Top Mark Definitions

|   |   |
|---|---|
| 1 | Fairchild Logo  |
| 2 | Device Number   |
| 3 | DIN EN/IEC60747-5-5 Option (only appears on component ordered with this option) |
| 4 | One-Digit Year Code, e.g., "4"  |
| 5 | Digit Work Week, Ranging from "01" to "53"                                      |
| 6 | Assembly Package Code   |



NOTES:

- A) NO STANDARD APPLIES TO THIS PACKAGE.
- B) ALL DIMENSIONS ARE IN MILLIMETERS.
- C) DIMENSIONS ARE EXCLUSIVE OF BURRS, MOLD FLASH, AND TIE BAR EXTRUSION
- D) DRAWING FILENAME AND REVISION: MKT-N06BREV4.





LAND PATTERN RECOMMENDATION



NOTES:

- A) NO STANDARD APPLIES TO THIS PACKAGE.
- B) ALL DIMENSIONS ARE IN MILLIMETERS.
- C) DIMENSIONS ARE EXCLUSIVE OF BURRS, MOLD FLASH, AND TIE BAR EXTRUSION
- D) DRAWING FILENAME AND REVISION : MKT-N06CREV4.





NOTES:

- A) NO STANDARD APPLIES TO THIS PACKAGE.
- B) ALL DIMENSIONS ARE IN MILLIMETERS.
- C) DIMENSIONS ARE EXCLUSIVE OF BURRS, MOLD FLASH, AND TIE BAR EXTRUSION
- D) DRAWING FILENAME AND REVISION: MKT-N06Drev4



ON Semiconductor and  are trademarks of Semiconductor Components Industries, LLC dba ON Semiconductor or its subsidiaries in the United States and/or other countries. ON Semiconductor owns the rights to a number of patents, trademarks, copyrights, trade secrets, and other intellectual property. A listing of ON Semiconductor's product/patent coverage may be accessed at [www.onsemi.com/site/pdf/Patent-Marking.pdf](http://www.onsemi.com/site/pdf/Patent-Marking.pdf). ON Semiconductor reserves the right to make changes without further notice to any products herein. ON Semiconductor makes no warranty, representation or guarantee regarding the suitability of its products for any particular purpose, nor does ON Semiconductor assume any liability arising out of the application or use of any product or circuit, and specifically disclaims any and all liability, including without limitation special, consequential or incidental damages. Buyer is responsible for its products and applications using ON Semiconductor products, including compliance with all laws, regulations and safety requirements or standards, regardless of any support or applications information provided by ON Semiconductor. "Typical" parameters which may be provided in ON Semiconductor data sheets and/or specifications can and do vary in different applications and actual performance may vary over time. All operating parameters, including "Typicals" must be validated for each customer application by customer's technical experts. ON Semiconductor does not convey any license under its patent rights nor the rights of others. ON Semiconductor products are not designed, intended, or authorized for use as a critical component in life support systems or any FDA Class 3 medical devices or medical devices with a same or similar classification in a foreign jurisdiction or any devices intended for implantation in the human body. Should Buyer purchase or use ON Semiconductor products for any such unintended or unauthorized application, Buyer shall indemnify and hold ON Semiconductor and its officers, employees, subsidiaries, affiliates, and distributors harmless against all claims, costs, damages, and expenses, and reasonable attorney fees arising out of, directly or indirectly, any claim of personal injury or death associated with such unintended or unauthorized use, even if such claim alleges that ON Semiconductor was negligent regarding the design or manufacture of the part. ON Semiconductor is an Equal Opportunity/Affirmative Action Employer. This literature is subject to all applicable copyright laws and is not for resale in any manner.

## PUBLICATION ORDERING INFORMATION

### LITERATURE FULFILLMENT:

Literature Distribution Center for ON Semiconductor  
19521 E. 32nd Pkwy, Aurora, Colorado 80011 USA  
**Phone:** 303-675-2175 or 800-344-3860 Toll Free USA/Canada  
**Fax:** 303-675-2176 or 800-344-3867 Toll Free USA/Canada  
**Email:** [orderlit@onsemi.com](mailto:orderlit@onsemi.com)

**N. American Technical Support:** 800-282-9855 Toll Free  
USA/Canada  
**Europe, Middle East and Africa Technical Support:**  
Phone: 421 33 790 2910  
**Japan Customer Focus Center**  
Phone: 81-3-5817-1050

**ON Semiconductor Website:** [www.onsemi.com](http://www.onsemi.com)  
**Order Literature:** <http://www.onsemi.com/orderlit>  
For additional information, please contact your local  
Sales Representative

# Mouser Electronics

Authorized Distributor

Click to View Pricing, Inventory, Delivery & Lifecycle Information:

[ON Semiconductor:](#)

[CNY173SR2VM](#) [CNY173SR2M](#) [CNY173VM](#) [CNY173TVM](#) [CNY173SM](#) [CNY173M](#) [CNY173SVM](#)

## Данный компонент на территории Российской Федерации

### Вы можете приобрести в компании MosChip.

Для оперативного оформления запроса Вам необходимо перейти по данной ссылке:

<http://moschip.ru/get-element>

Вы можете разместить у нас заказ для любого Вашего проекта, будь то серийное производство или разработка единичного прибора.

В нашем ассортименте представлены ведущие мировые производители активных и пассивных электронных компонентов.

Нашей специализацией является поставка электронной компонентной базы двойного назначения, продукции таких производителей как XILINX, Intel (ex.ALTERA), Vicor, Microchip, Texas Instruments, Analog Devices, Mini-Circuits, Amphenol, Glenair.

Сотрудничество с глобальными дистрибьюторами электронных компонентов, предоставляет возможность заказывать и получать с международных складов практически любой перечень компонентов в оптимальные для Вас сроки.

На всех этапах разработки и производства наши партнеры могут получить квалифицированную поддержку опытных инженеров.

Система менеджмента качества компании отвечает требованиям в соответствии с ГОСТ Р ИСО 9001, ГОСТ РВ 0015-002 и ЭС РД 009

### Офис по работе с юридическими лицами:

105318, г.Москва, ул.Щербаковская д.3, офис 1107, 1118, ДЦ «Щербаковский»

Телефон: +7 495 668-12-70 (многоканальный)

Факс: +7 495 668-12-70 (доб.304)

E-mail: [info@moschip.ru](mailto:info@moschip.ru)

Skype отдела продаж:

moschip.ru

moschip.ru\_4

moschip.ru\_6

moschip.ru\_9