

## Step-up DC/DC Converter with Shutdown Function

NO.EA-284-130409

### OUTLINE

The R1204x Series are low supply current CMOS-based PWM step-up DC/DC converters. Internally, a single IC consists of an NMOS FET, an oscillator, a PWM comparator, a voltage reference unit, an error amplifier, a current limit circuit, an under voltage lockout circuit (UVLO), an over-voltage protection circuit (OVP), a soft-start circuit, a maximum duty cycle limit circuit, and a thermal shutdown protection circuit. By simply using an inductor, a resistor, capacitors and a diode as external components, a high-efficiency step-up DC/DC converter can be easily configured.

As protection functions, the IC contains a thermal shutdown protection circuit, a current limit circuit, an OVP circuit, and an UVLO circuit. A thermal shutdown circuit detects overheating of the ICs and stops the operation to protect it from damage. A current limit circuit limits the peak current of Lx, and an OVP circuit detects the over voltage of output, and an UVLO circuit detects the low input voltage.

The R1204x Series provide the R1204xxxA/D/G/H versions, which are optimized for serial driving of white LEDs with constant current, and the R1204xxxB/C/E/F versions, which are optimized for constant voltage driving. Among the R1204xxxB/C/E/F versions, only the R1204xxxC/F versions are equipped with PWM/VFM auto switching controls. The LED current can be determined by the value of current setting resistor. The brightness of the LEDs can be quickly adjusted by applying a PWM signal (200Hz to 300kHz) to the CE pin. The R1204x Series are available in DFN(PLP)1820-6 and TSOT-23-6 packages.

### FEATURES

- Input Voltage Range ..... 2.3V to 5.5V
- Supply Current..... Typ. 800 $\mu$ A
- Standby Current..... Max. 5 $\mu$ A
- Feedback Voltage..... 0.2V $\pm$ 10mV (R1204xxxxA/D)  
0.4V $\pm$ 10mV(R1204xxxxG/H)  
1.0V $\pm$ 15mV (R1204xxxxB/C/E/F)
- Lx Current Limit Function ..... Min. 700mA
- Over Voltage Protection ..... 23V, 33V, 42V ( $\pm$ 1.5V)
- Oscillator Frequency ..... Typ. 1.0MHz (R1204xxxxA/B/C/G)  
Typ. 750kHz (R1204xxxxD/E/F/H)
- Maximum Duty Cycle ..... Min. 91% (R1204xxxxA/B/C/G)  
Min. 92% (R1204xxxxD/E/F/H)
- FET ON Resistance..... Typ. 0.8 $\Omega$
- UVLO Function
- Thermal Protection Function
- LED Dimming Control for R1204xxxxA/D ..... by external PWM signal (200Hz to 300kHz frequency)
- Packages..... DFN(PLP)1820-6, TSOT-23-6
- Recommended Bypass Capacitor..... 1.0 $\mu$ F

### APPLICATIONS

- Constant voltage power source for hand-held equipment
- OLED power supply for hand-held equipment
- White LED driver for hand-held equipment

BLOCK DIAGRAMS

R1204xxxxA/D/G/H



R1204xxxxB/E



R1204xxxxC/F



## SELECTION GUIDE

The package type, the OVP detector threshold, the feedback voltage and the PWM/VFM auto switching control are user-selectable options as described below.

Product Name	Package	Quantity per Reel	Pb Free	Halogen Free
R1204Kxy2z-TR	DFN(PLP)1820-6	5,000 pcs	Yes	Yes
R1204Nxy3z-TR-FE	TSOT-23-6	3,000 pcs	Yes	Yes

x: Designation of OVP detector threshold

- (1) 23V
- (2) 33V
- (3) 42V

y: Designation of current limit

- (1) Typ. 900mA

z: Designation of the feedback voltage, the oscillator frequency, the PWM/VFM auto switching control

z	Feedback Voltage	Oscillator Frequency	PWM/VFM Auto Switching Control
(A)	Typ. 0.2V	Typ. 1MHz	No
(B)	Typ. 1V		No
(C)	Typ. 1V		Yes
(D)	Typ. 0.2V	Typ. 750kHz	No
(E)	Typ. 1V		No
(F)	Typ. 1V		Yes
(G)	Typ. 0.4V	Typ. 1MHz	No
(H)		Typ. 750kHz	

## PIN CONFIGURATIONS



## PIN DESCRIPTIONS

### • DFN(PLP)1820-6

Pin No	Symbol	Description
1	$V_{OUT}$	Output Pin
2	$L_X$	Switching Pin (Open Drain Output)
3	GND	Ground Pin
4	$V_{IN}$	Input Pin
5	CE	Chip Enable Pin ("H" Active)
6	$V_{FB}$	Feedback Pin

The exposed tab is substrate level (GND). It is recommended that the exposed tab be connected to the ground plane on the board or otherwise be left open.

### • TSOT-23-6

Pin No	Symbol	Description
1	$L_X$	Switching Pin (Open Drain Output)
2	GND	Ground Pin
3	$V_{FB}$	Feedback Pin
4	CE	Chip Enable Pin ("H" Active)
5	$V_{OUT}$	Output Pin
6	$V_{IN}$	Input Pin

## ABSOLUTE MAXIMUM RATINGS

(GND=0V)

Symbol	Item	Rating		Unit
$V_{IN}$	$V_{IN}$ Pin Voltage	-0.3 to 6.5		V
$V_{CE}$	CE Pin Voltage	-0.3 to 6.5		V
$V_{FB}$	$V_{FB}$ Pin Voltage	-0.3 to 6.5		V
$V_{OUT}$	$V_{OUT}$ Pin Voltage	-0.3 to 48		V
$V_{LX}$	$L_X$ Pin Voltage	-0.3 to 48		V
$I_{LX}$	$L_X$ Pin Current	1200		mA
$P_D$	Power Dissipation (Standard Test Land Pattern) <sup>*1</sup>	DFN(PLP)1820-6	880	mW
		TSOT-23-6	460	
$T_a$	Operating Temperature Range	-40 to +85		°C
$T_{stg}$	Storage Temperature Range	-55 to +125		°C

<sup>\*1</sup> For more information about Power Dissipation and Standard Land Pattern, please refer to *PACKAGE INFORMATION*.

### ABSOLUTE MAXIMUM RATINGS

Electronic and mechanical stress momentarily exceeded absolute maximum ratings may cause the permanent damages and may degrade the lifetime and safety for both device and system using the device in the field. The functional operation at or over these absolute maximum ratings is not assured.

### RECOMMENDED OPERATING CONDITIONS (ELECTRICAL CHARACTERISTICS)

All of electronic equipment should be designed that the mounted semiconductor devices operate within the recommended operating conditions. The semiconductor devices cannot operate normally over the recommended operating conditions, even if when they are used over such conditions by momentary electronic noise or surge. And the semiconductor devices may receive serious damage when they continue to operate over the recommended operating conditions.

## ELECTRICAL CHARACTERISTICS

(Ta=25°C)

Symbol	Item	Conditions	Min.	Typ.	Max.	Unit	
$V_{IN}$	Operating Input Voltage		2.3		5.5	V	
$I_{DD}$	Supply Current	$V_{IN}=5.5V$ , $V_{FB}=0V$ , $L_X$ at no load		0.8		mA	
Istandby	Standby Current	$V_{IN}=5.5V$ , $V_{CE}=0V$		1.0	5.0	$\mu A$	
$V_{UVLO1}$	UVLO Detector Threshold	$V_{IN}$ falling	1.9	2.0	2.1	V	
$V_{UVLO2}$	UVLO Released Voltage	$V_{IN}$ rising		$V_{UVLO1}+0.1$		V	
$V_{CEH}$	CE Input Voltage "H"	$V_{IN}=5.5V$	1.5			V	
$V_{CEL}$	CE Input Voltage "L"	$V_{IN}=2.3V$			0.5	V	
$R_{CE}$	CE Pull Down Resistance	$V_{IN}=3.6V$	R1204xxxxA/B/D/E/G/H		1200	k $\Omega$	
			R1204xxxxC/F		600		
$V_{FB}$	$V_{FB}$ Voltage Accuracy	$V_{IN}=3.6V$	R1204xxxxA/D	0.19	0.2	0.21	V
			R1204xxxxG/H	0.39	0.4	0.41	
			R1204xxxxB/C/E/F	0.985	1.000	1.015	
$I_{FB}$	$V_{FB}$ Input Current	$V_{IN}=5.5V$ , $V_{FB}=0V$ or $5.5V$	-0.1		0.1	$\mu A$	
Tstart	Soft-start Time	$V_{IN}=3.6V$ , R1204xxxxB/C/E/F		10		ms	
$R_{ON}$	FET ON Resistance	$V_{IN}=3.6V$ , $I_{LX}=100mA$		0.8		$\Omega$	
$I_{LXLEAK}$	FET Leakage Current	$V_{LX}=40V$			3.0	$\mu A$	
$I_{LXLIM}$	FET Current Limit	$V_{IN}=3.6V$	700	900	1100	mA	
fosc	Oscillator Frequency	$V_{IN}=3.6V$ , $V_{FB}=0V$	R1204xxxxA/B/C/G	0.9	1.0	1.1	MHz
			R1204xxxxD/E/F/H	675	750	825	kHz
Maxduty	Oscillator Maximum Duty Cycle	$V_{IN}=3.6V$ , $V_{FB}=0V$	R1204xxxxA/B/C/G	91			%
			R1204xxxxD/E/F/H	92			%
$V_{OVP1}$	OVP Detector Threshold	$V_{IN}=3.6V$ , $V_{OUT}$ rising	R1204x1xxx	22	23	24.0	V
			R1204x2xxx	31.5	33	34.5	
			R1204x3xxx	40.2	42	43.8	
$V_{OVP2}$	OVP Released Voltage	$V_{IN}=3.6V$ , $V_{OUT}$ falling	R1204x1xxx		$V_{OVP1}-0.6$		V
			R1204x2xxx		$V_{OVP1}-1.2$		
			R1204x3xxx		$V_{OVP1}-2.4$		
$T_{TSD}$	Thermal Shutdown Temperature	$V_{IN}=3.6V$		150		$^{\circ}C$	
$T_{TSR}$	Thermal Shutdown Released Temperature	$V_{IN}=3.6V$		100		$^{\circ}C$	

All test items listed under Electrical Characteristics are done under the pulse load condition ( $T_j \approx T_a = 25^{\circ}C$ ).

TYPICAL APPLICATIONS AND NOTES CONCERNING EXTERNAL COMPONENTS

• Typical Applications

R1204xxxxA/D/G/H



Figure 1.



Figure 2.

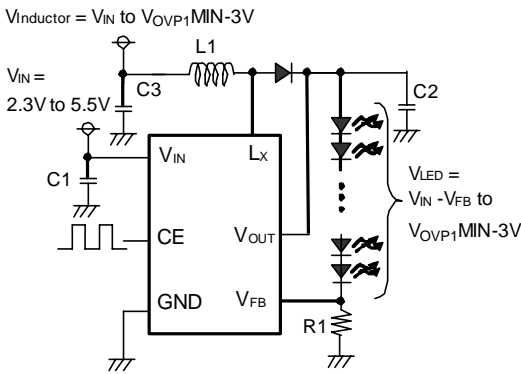

Figure 3.

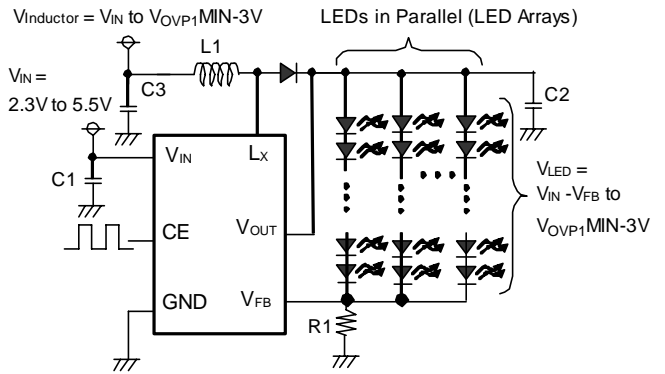

Figure 4.

R1204xxxxB/C/E/F



Figure 5.

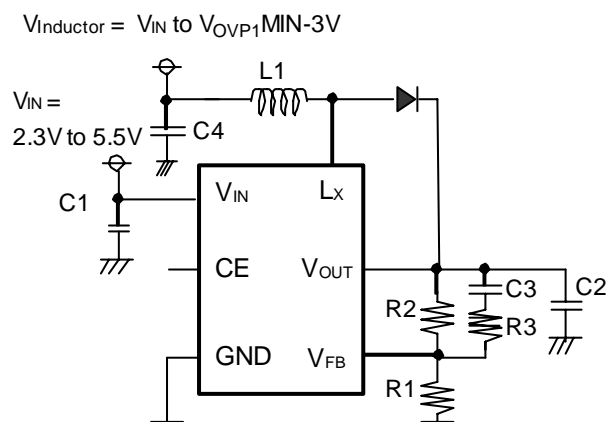

Figure 6.



Table 1. Recommended Inductors

L1 ( $\mu$ H)	Parts No.	Rated Current (mA)	Size (mm)	Versions
10	VLS252010ET-100M	550	2.5×2.0×1.0	R1204xxxxA/B/C/G
10	VLF302512MT-100M	620	3.0×2.5×1.2	
10	VLF403212MT-100M	900	4.0×3.2×1.2	
22	VLF302512MT-220M	430	3.0×2.5×1.2	R1204xxxxD/E/F/H
22	VLF403212MT-220M	540	4.0×3.2×1.2	
22	VLF504012MT-220M	800	5.0×4.0×1.2	

Table 2. Recommended Components for R1204xxxxA/D/G/H

Symbol	Rated Voltage (V)	Parts No.
D1	60	CRS12
C1	6.3	CM105B105K06
C2	50	C2012X5R1H105K
		R1204xxxxG/H ( $I_{LED}>22$ mA): C2012X5R1H225K
C3	16	C2012X5R1C105K

Symbol	R1204x	Values
R1	R1204xxxxA/D	(10/ LED Arrays <sup>*1</sup> ( $\Omega$ ))
	R1204xxxxG/H	(20/ LED Arrays <sup>*1</sup> ( $\Omega$ ))

\*1 LED Arrays indicate the number of parallel LEDs in series.

Table 3. Recommended Components for R1204xxxxB/C/E/F

Symbol	Rated Voltage (V)	Parts No.
D1	60	CRS12
C1	6.3	CM105B105K06
C2	16	C2012X5R1C475K
	25	C2012X5R1E105K
	50	C2012X5R1H105K
C4	16	C2012X5R1C105K

Table 4. Recommended Component Values for R1204xxxxB/C/E/F

$V_{SET}$ (V)	$7 < V_{SET} \leq 10$	$10 < V_{SET} \leq 25$	$25 < V_{SET}$
R1 (k $\Omega$ )	10	10	10
R2 (k $\Omega$ )	$(V_{SET} - 1) \times R1$	$(V_{SET} - 1) \times R1$	$(V_{SET} - 1) \times R1$
R3 ( $\Omega$ )	0	0	0
C1 ( $\mu$ F)	1.0	1.0	1.0
C2 ( $\mu$ F)	4.7	$1.0 \times 2$	1.0
C3 (pF)	10	10	10
C4 ( $\mu$ F)	1.0	1.0	1.0

## Notes Concerning External Components

- **LED Current Setting (R1204xxxxA/D/G/H)**

The LED current ( $I_{LED}$ ) when a "H" signal is applied to the CE pin (Duty=100%) can be determined by the value of feedback resistor (R1).

$$I_{LED} = 0.2 / R1 \quad (\text{R1204xxxxA/D})$$

$$I_{LED} = 0.4 / R1 \quad (\text{R1204xxxxG/H})$$

- **LED Dimming Control (R1204xxxxA/D/G/H)**

The brightness of the LEDs can be adjusted by applying a PWM signal to the CE pin. By inputting "L" voltage for a certain period of time (Typ. 9ms(R1204xxxxA/G) / 12ms(R1204xxxxD/H) or more), the IC goes into standby mode and turns off LEDs.  $I_{LED}$  can be controlled by the duty of a PWM signal for the CE pin.

The relation between the high-duty of the CE pin (Hduty) and  $I_{LED}$  is calculatable by the following formula.

$$I_{LED} = Hduty \times V_{FB} / R1$$

The frequency range of a PWM signal should be set within the range of 200Hz to 300kHz.

In the case of using a 20kHz or less PWM signal for dimming the LEDs, the increasing or decreasing of the inductor current ( $I_L$ ) may make noise in the audible band. In this case, a high frequency PWM signal should be used.

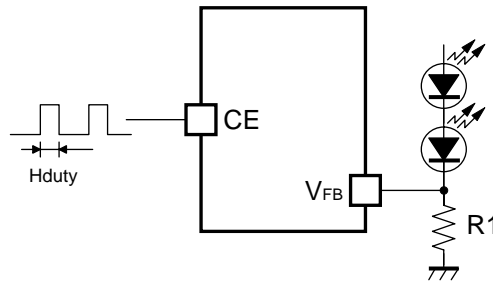

Figure 7. Dimming Control by CE Pin

- **Low luminance Dimming Accuracy (R1204xxxxG/H)**

Low luminance Dimming filtered  $V_{FB}$  voltage tolerance depends on the offset voltage of the internal DC/DC converter. By this offset voltage, some voltage difference may be generated between  $V_{REF}$  voltage and  $V_{FB}$  voltage. Low luminance Dimming Accuracy is shown in Table.5

Table 5. Low luminance Dimming Accuracy for R1204xxxxG/H (R1=20ohm)

The duty of a PWM signal for the CE pin	$I_{LED}$ Min.	$I_{LED}$ Max.
3.5% (Frequency = 20kHz ~ 300kHz)	0.01mA <sup>2</sup>	2.1mA <sup>2</sup>

<sup>2</sup> guaranteed by design engineering (Ta=25 °C)

### • Output Voltage Setting (R1204xxxxB/C/E/F)

The relation between the output voltage ( $V_{SET}$ ) and the resistors (R1, R2) is calculatable by the following formula.

$$V_{SET} = V_{FB} \times (R1 + R2) / R1$$

The sum of R1 and R2 should be 300kΩ or less.

Ensure the  $V_{IN}$  and GND lines are sufficiently robust. If their impedances are too high, noise pickup or unstable operation may result. Set a capacitor (C2) with a suitable voltage resistance (more than 1.5 times of  $V_{SET}$ ) between the  $V_{IN}$  and GND pins, and as close as possible to the pins.

### • PWM/VFM Auto Switching Control (R1204xxxxC/F)

In low output current, the IC automatically switches to high-efficiency VFM mode. The minimum Onduty ( $D_{ON\_MIN}$ ) of VFM mode is set to approximately 30% and is fixed inside the IC. If the difference between the voltages of the input and the output is small, or the Onduty in continuous mode ( $D_{ON\_CON}$ ) becomes lower than  $D_{ON\_MIN}$ , the IC will not shift to PWM mode but will stay with VFM mode instead even in high output current, as a result, the ripple current will be increased.  $D_{ON\_MIN}$  should be 70% or more ( $V_{SET} > V_{IN} \times 3.33$ ).

### • Current Limit Function

If the peak current of inductor ( $IL_{max}$ ) exceeds the current limit, current limit function turns the driver off and turns it on in every switching cycle to continually monitor the driver current.

### • Soft-Start Function

#### (R1204xxxxA/D/G/H)

Unless otherwise  $V_{OUT}$  is beyond the threshold ( $V_f \times$  number of LED lights), current will not flow through LEDs, as a result,  $V_{FB}$  voltage will not increase. The IC increases  $V_{OUT}$  by controlling the output of error amplifier to “H” and turning the  $L_x$  switch on and off for a certain period of time (until the current flow). At the mean time, the inrush current is controlled by gradually increasing the current limit. If  $V_{OUT}$  is over the threshold (the current flows), the IC controls the soft-start function by gradually increasing the reference voltage of error amplifier.

#### (R1204xxxxB/C/E/F)

The IC controls the soft-start function by gradually increasing the reference voltage of error amplifier. Soft-start begins when the output voltage of error amplifier is 0V and ends when it reaches the constant voltage.

### • Under Voltage Lock Out Function (UVLO)

UVLO function stops DC/DC operation and prevents malfunction when the supply voltage falls below the UVLO detector threshold.

### • Over Voltage Protection Circuit (OVP)

OVP circuit monitors the  $V_{OUT}$  pin voltage and if it reaches the OVP voltage it will stop oscillation. When the  $V_{OUT}$  pin voltage decreases it will restart oscillation, but if the cause of the excess  $V_{OUT}$  pin voltage is not removed the OVP circuit will operate repeatedly so as to restrict the  $V_{OUT}$  pin voltage.

### • Thermal Shutdown Function

If the junction temperature exceeds the thermal shutdown temperature, thermal shutdown function turns the driver off. If the junction temperature becomes lower than the thermal shutdown released temperature, the thermal shutdown function resets the IC to restart the operation.

- **Selection of Capacitor**

Set a 1 $\mu$ F or more input capacitor (C1) between the V<sub>IN</sub> and GND pins as close as possible to the pins.

Set a 1 $\mu$ F to 10 $\mu$ F output capacitor (C2) between the V<sub>OUT</sub> and GND pins.

R1204xxxxA/D: Set C2 with 1 $\mu$ F to 4.7 $\mu$ F between the V<sub>OUT</sub> and GND pins.

R1204xxxxB/C/E/F: Set C2 with 1 $\mu$ F to 10 $\mu$ F between the V<sub>OUT</sub> and GND pins.

- **Selection of Inductor**

IL<sub>max</sub> under steady operation can be calculated by the formula below.

$$IL_{max} = 1.25 \times I_{LED} \times V_{OUT} / V_{IN} + 0.5 \times V_{IN} \times (V_{OUT} - V_{IN}) / (L \times V_{OUT} \times f_{osc})$$

When starting up the IC or adjusting the brightness of LED lights, a large transient current may flow into an inductor (L1). IL<sub>max</sub> of L1 should be equal or smaller than the current limit of the IC. L with 10 $\mu$ H to 22 $\mu$ H is recommended.

- **Other External Components Settings**

Set a capacitor (C3) between the V<sub>OUT</sub> and V<sub>FB</sub> pins to improve the response of DC/DC converter by giving high-frequency voltage feedback. Please note that C3 operation could be different from the theory of operation depending on component layouts and parasitic capacitances.

## OPERATION OF STEP-UP DC/DC CONVERTER AND OUTPUT CURRENT

Figure 8. Basic Circuits



Figure 9. The inductor current (IL) flowing through the inductor (L)



Discontinuous Mode

Continuous Mode

There are two operation modes in the PWM step-up DC/DC converter: continuous mode and discontinuous mode.

When a transistor is in the On-state, the voltage to be applied to L is described as  $V_{IN}$ . An increase in the inductor current ( $i_1$ ) can be written as follows:

$$\Delta i_1 = V_{IN} \times t_{on} / L \dots\dots\dots \text{Formula 1}$$

In the step-up circuit, the energy accumulated during the On-state is transferred into the capacitor even in the Off-state. A decrease in the inductor current ( $i_2$ ) can be written as follows:

$$\Delta i_2 = (V_{OUT} - V_{IN}) \times t_{open} / L \dots\dots\dots \text{Formula 2}$$

In the PWM switching control,  $i_1$  and  $i_2$  become continuous when  $t_{open}=t_{off}$ , which is called continuous mode.

When the IC is in the continuous mode and operates in steady-state conditions, the variations of  $i_1$  and  $i_2$  are same:

$$V_{IN} \times t_{on} / L = (V_{OUT} - V_{IN}) \times t_{off} / L \dots\dots\dots \text{Formula 3}$$

Therefore, the duty cycle in the continuous mode is:

$$\text{Duty} = t_{on} / (t_{on} + t_{off}) = (V_{OUT} - V_{IN}) / V_{OUT} \dots\dots\dots \text{Formula 4}$$

When  $t_{open}=t_{off}$ , the average of  $I_L$  is:

$$I_L (\text{Ave.}) = V_{IN} \times t_{on} / (2 \times L) \dots\dots\dots \text{Formula 5}$$

If the input voltage ( $V_{IN}$ ) is equal to  $V_{OUT}$ , the output current ( $I_{OUT}$ ) is:

$$I_{OUT} = V_{IN}^2 \times t_{on} / (2 \times L \times V_{OUT}) \dots\dots\dots \text{Formula 6}$$

If  $I_{OUT}$  is larger than Formula 6, the IC switches to the continuous mode.

$I_{Lmax}$  flowing through  $L$  is:

$$I_{Lmax} = I_{OUT} \times V_{OUT} / V_{IN} + V_{IN} \times t_{on} / (2 \times L) \dots\dots\dots \text{Formula 7}$$

$$I_{Lmax} = I_{OUT} \times V_{OUT} / V_{IN} + V_{IN} \times T \times (V_{OUT} - V_{IN}) / (2 \times L \times V_{OUT}) \dots\dots\dots \text{Formula 8}$$

As a result,  $I_{Lmax}$  becomes larger compared to  $I_{OUT}$ .

When considering the input and output conditions or selecting the external components, please pay attention to  $I_{Lmax}$ .

- ★ The above calculations are based on the ideal operation of the ICs in the continuous mode. They do not include the losses caused by the external components or  $L_x$  switch. The actual maximum output current will be 50% to 80% of the above calculation results. Especially, if  $I_L$  is large or  $V_{IN}$  is low, it may cause the switching losses. As for  $V_{OUT}$ , please consider  $V_F$  of the diode (approximately 0.8V).

## TYPICAL CHARACTERISTICS

### 1) Efficiency vs. Output Current of R1204xxxxA/D/G/H

(LED used: NSSW208A (NICHIA)  $V_f=3.0V$  ( $I_{LED}=20mA$ ))

#### 1-1) Efficiency vs. Output Current with Different Output Voltages

10 LEDs in Series ( $V_{OUT}=30V$  ( $I_{OUT}=20mA$ ))

R1204xxxxA/G,  $L=10\mu H$  (VLF302512MT-100M)



R1204xxxxD/H,  $L=22\mu H$  (VLF302512MT-220M)



8 LEDs in Series ( $V_{OUT}=24V$  ( $I_{OUT}=20mA$ ))

R1204xxxxA/G,  $L=10\mu H$  (VLF302512MT-100M)

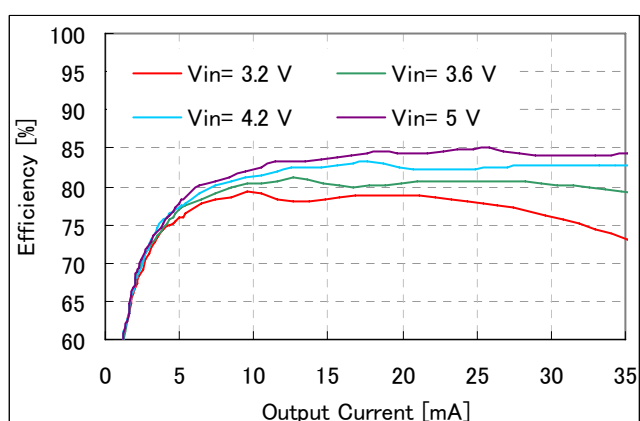

R1204xxxxD/H,  $L=22\mu H$  (VLF302512MT-220M)

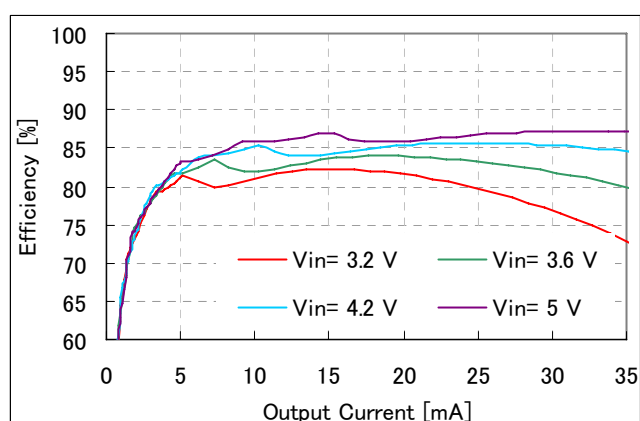

6 LEDs in Series ( $V_{OUT}=18V$  ( $I_{OUT}=20mA$ ))

R1204xxxxA/G,  $L=10\mu H$  (VLF302512MT-100M)

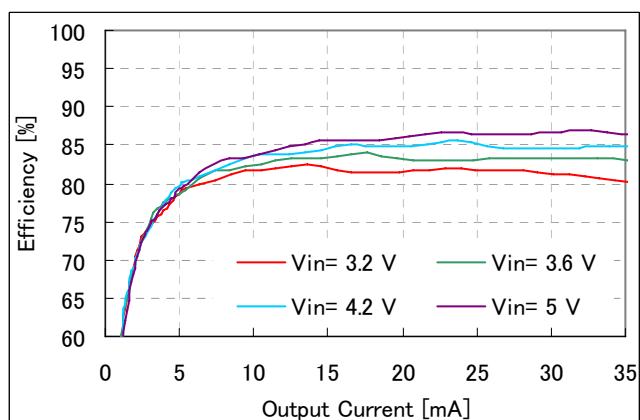

R1204xxxxD/H,  $L=22\mu H$  (VLF302512MT-220M)

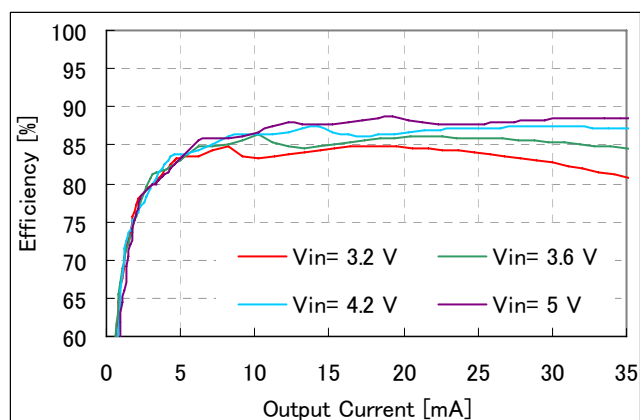

1-2) Efficiency vs. Output Current with Different Inductors ( $V_{IN}=3.6V$ )

10 LEDs in Series ( $V_{OUT}=30V$  ( $I_{OUT}=20mA$ ))

R1204xxxxA/G



R1204xxxxD/H

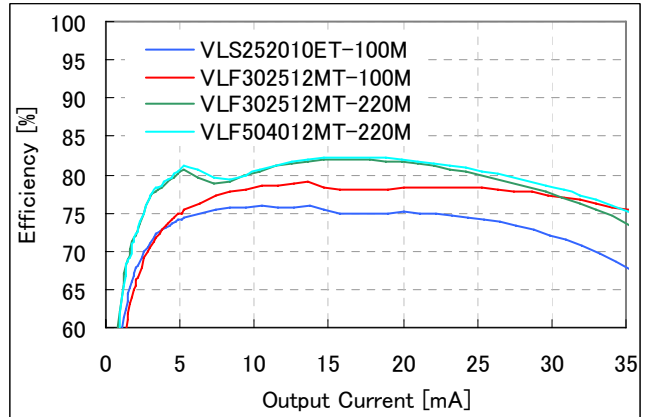

8 LEDs in Series ( $V_{OUT}=24V$  ( $I_{OUT}=20mA$ ))

R1204xxxxA/G



R1204xxxxD/H

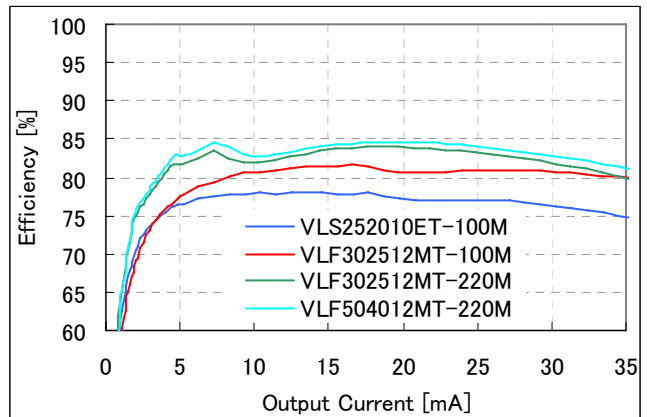

1-3) Efficiency vs. Output Current with Different Numbers of LEDs

LEDs in 3 Parallels ( $V_{IN}=3.6V$ )

R1204xxxxA/G,  $L=10\mu H$  (VLF302512MT-100M)



R1204xxxxD/H,  $L=22\mu H$  (VLF302512MT-220M)

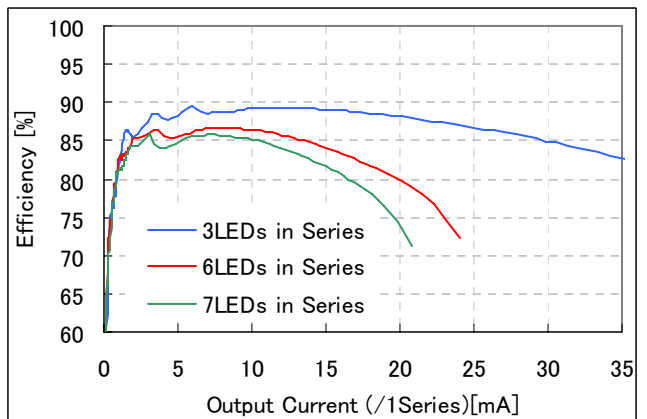

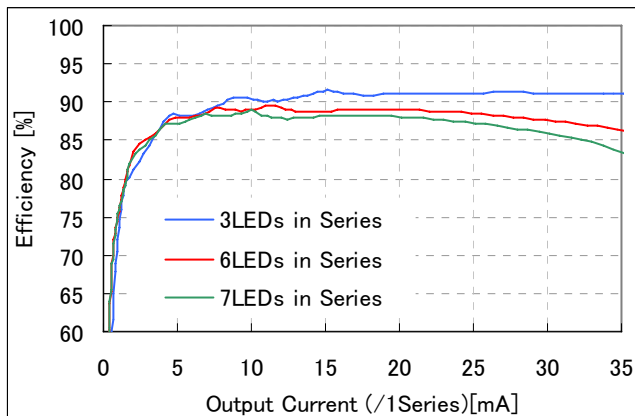
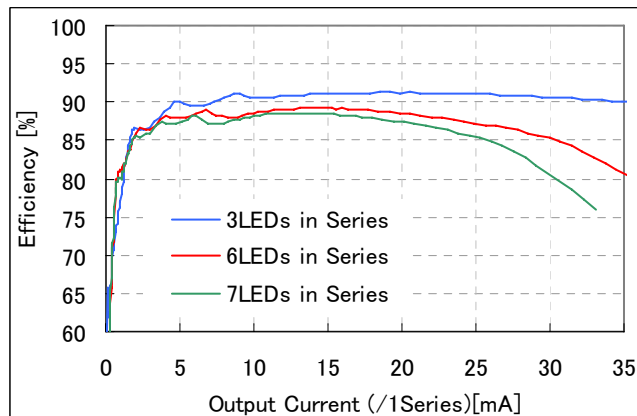

LEDs in 3 Parallels ( $V_{IN}=5.0V$ )R1204xxxxA/G,  $L=10\mu H$  (VLF302512MT-100M)R1204xxxxD/H,  $L=22\mu H$  (VLF302512MT-220M)

## 1-4) Efficiency vs. Output Current with Different Numbers of LEDs

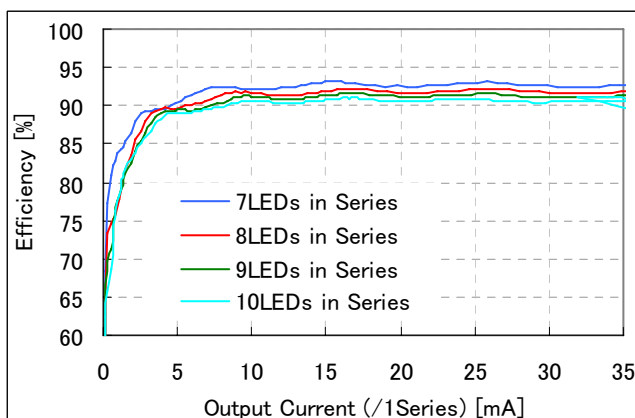
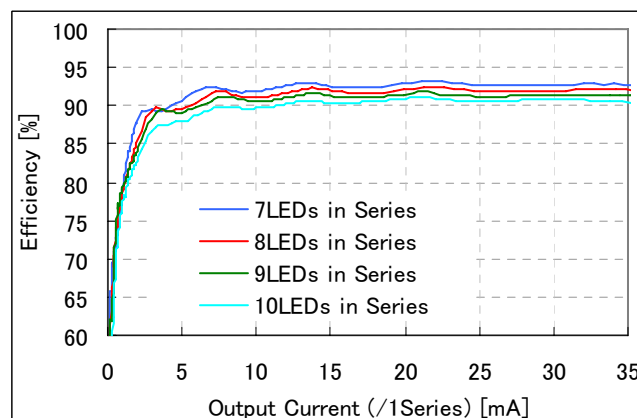
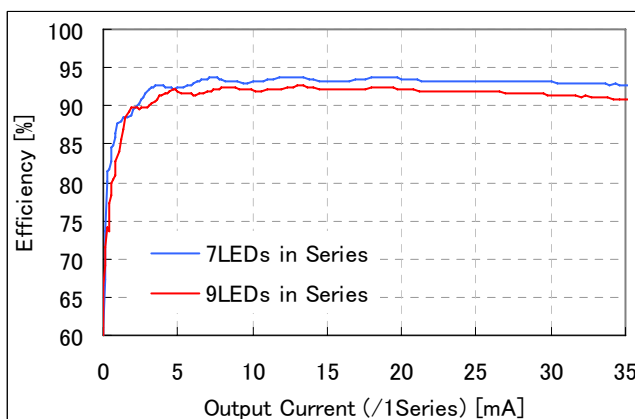
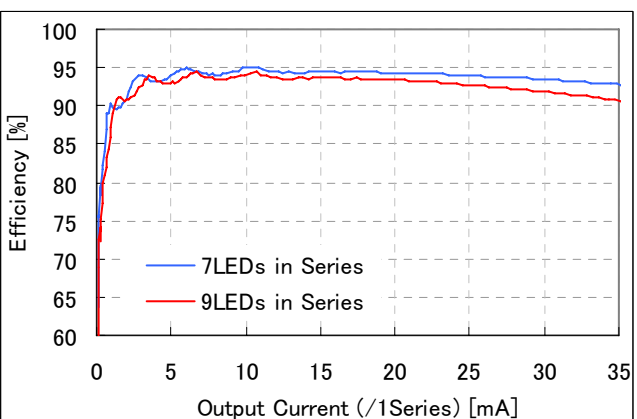
LEDs in 3 Parallels ( $V_{IN}=3.6V$ , Inductor Voltage=12.0V)R1204xxxxA/G,  $L=10\mu H$  (VLF302512MT-100M)R1204xxxxD/H,  $L=22\mu H$  (VLF302512MT-220M)LEDs in 6 Parallels ( $V_{IN}=3.6V$ , Inductor Voltage=12.0V)R1204xxxxA/G,  $L=10\mu H$  (VLF302512MT-100M)R1204xxxxD/H,  $L=22\mu H$  (VLF302512MT-220M)

2) Efficiency vs. Output Current of R1204xxxxB/C/E/F

2-1) Efficiency vs. Output Current with Different Output Voltages

$V_{SET}=31V$

$V_{IN}$  = Inductor Voltages

R1204xxxxC, L=10 $\mu$ H (VLF302512MT-100M)



R1204xxxxF, L=22 $\mu$ H (VLF302512MT-220M)

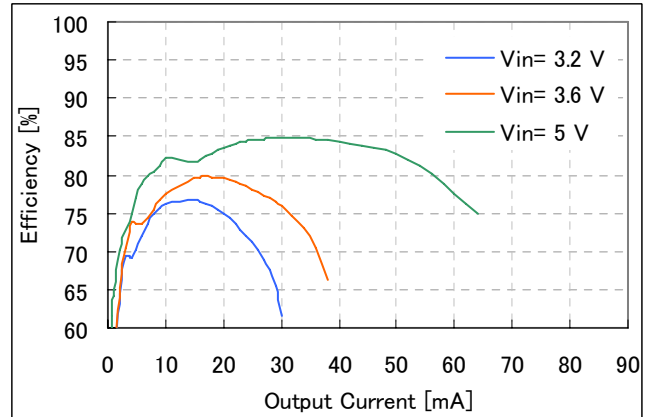

Different  $V_{IN}$ / Inductor Voltages ( $V_{IN}=3.6V$ )

R1204xxxxC, L=10 $\mu$ H (VLF302512MT-100M)

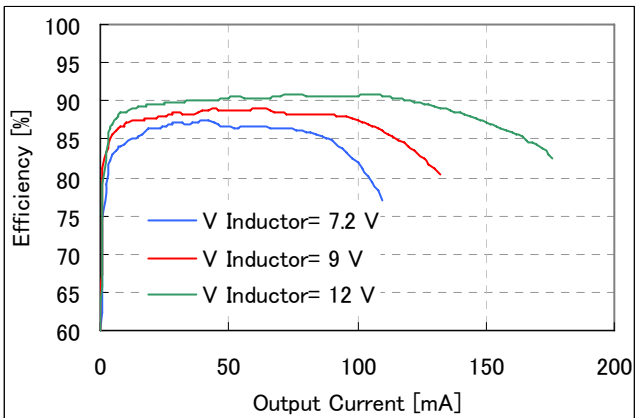

R1204xxxxF, L=22 $\mu$ H (VLF302512MT-220M)

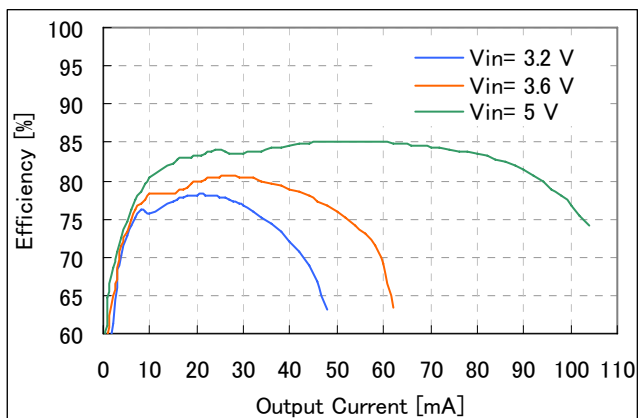
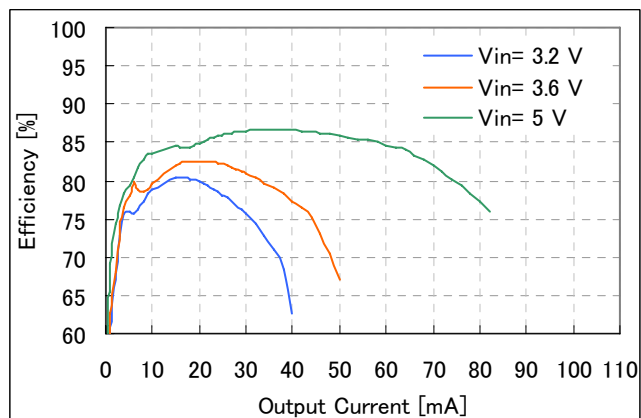
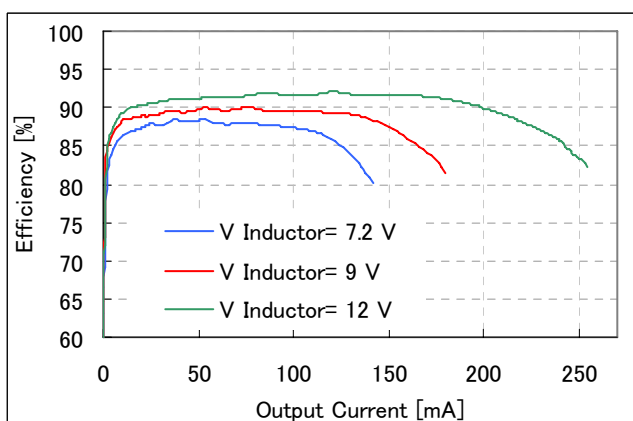
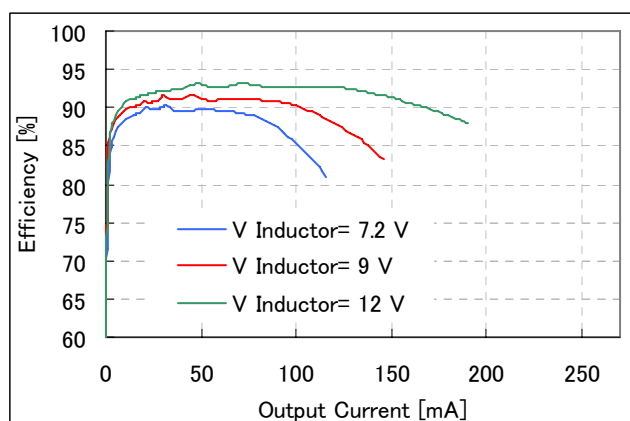

$V_{SET}=25V$  $V_{IN}$  = Inductor VoltagesR1204xxxxC, L=10 $\mu$ H (VLF302512MT-100M)R1204xxxxF, L=22 $\mu$ H (VLF302512MT-220M)Different  $V_{IN}$ / Inductor Voltages ( $V_{IN}=3.6V$ )R1204xxxxC, L=10 $\mu$ H (VLF302512MT-100M)R1204xxxxF, L=22 $\mu$ H (VLF302512MT-220M)

$V_{SET}=21V$

$V_{IN}$ =Inductor Voltages

R1204xxxxC, L=10 $\mu$ H (VLF302512MT-100M)



R1204xxxxF, L=22 $\mu$ H (VLF302512MT-220M)

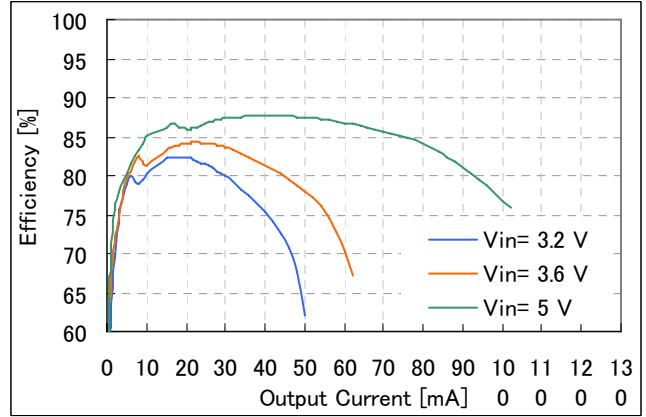

Different  $V_{IN}$ / Inductor Voltages ( $V_{IN}=3.6V$ )

R1204xxxxC, L=10 $\mu$ H (VLF302512MT-100M)



R1204xxxxF, L=22 $\mu$ H (VLF302512MT-220M)

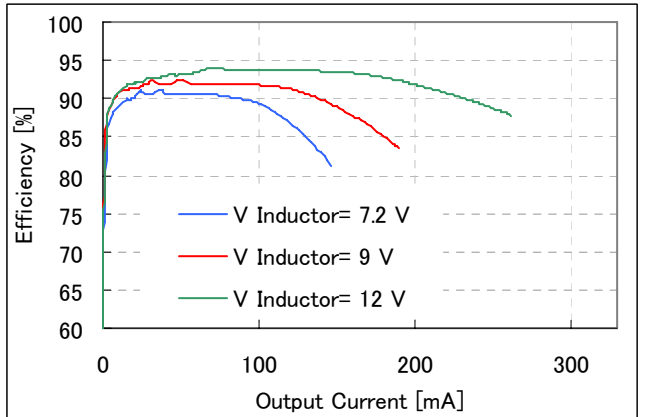

**2-2) Efficiency vs. Output Current with PWM Control and PWM/VFM Auto Switching Control**  
 ( $V_{IN}=3.6V$ ,  $V_{SET}=12V$ )

R1204xxxxB/C, L=10 $\mu$ H (VLF302512MT-100M)

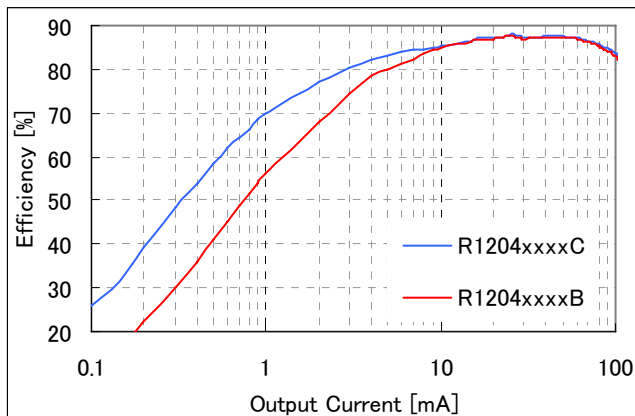

R1204xxxxE/F, L=22 $\mu$ H (VLF302512MT-220M)

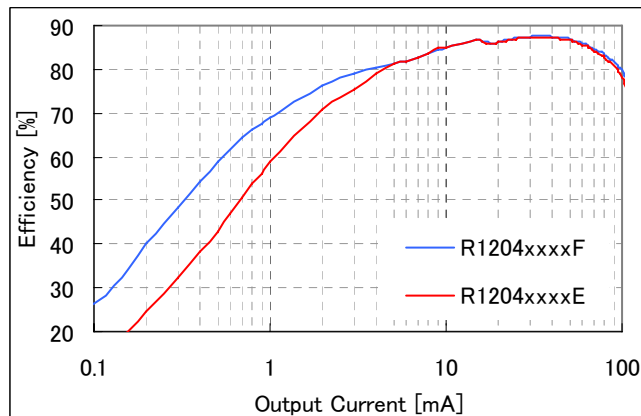

**Inductor Voltage=7.2V,  $V_{SET}=25V$**

R1204xxxxB/C, L=10 $\mu$ H (VLF302512MT-100M)

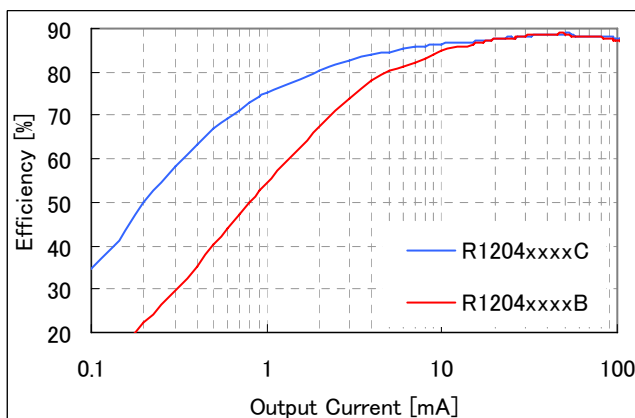

**3) Maxduty vs. ILED**

(R1204xxxxA/D/G/H, 10 LEDs in Series,  $V_{IN}=3.6V$ )

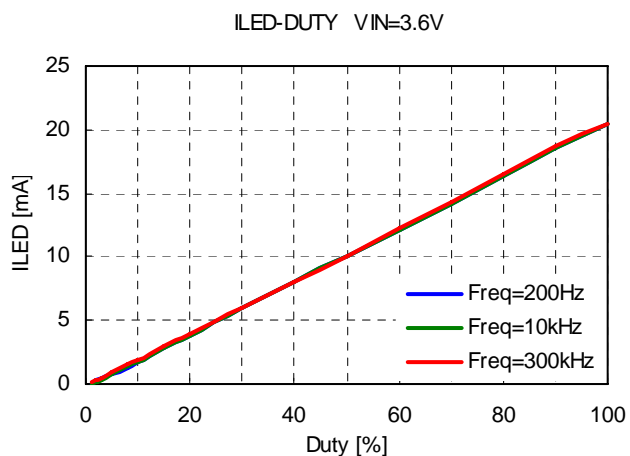

4)  $V_{OUT} / I_{LED}$  Ripple of R1204xxxxA/D/G/H When Dimming  
 (10 LEDs in Series,  $L=10\mu H$  (VLF302512MT-100M))

CE Freq=200Hz



CE Freq=10kHz

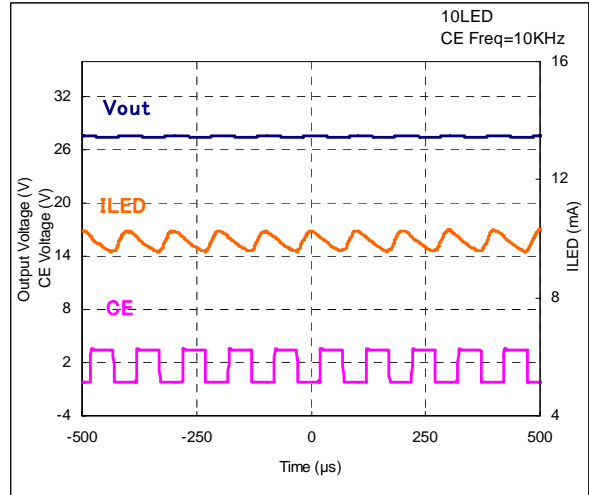

CE Freq=300kHz



5)  $V_{OUT}$  Ripple ( $V_{IN}=3.6V$ ,  $V_{SET}=21V$ ,  $I_{OUT}=0mA$ ,  $L=10\mu H$  (VLF302512MT-100M))

PWM Control (R1204xxxxB)

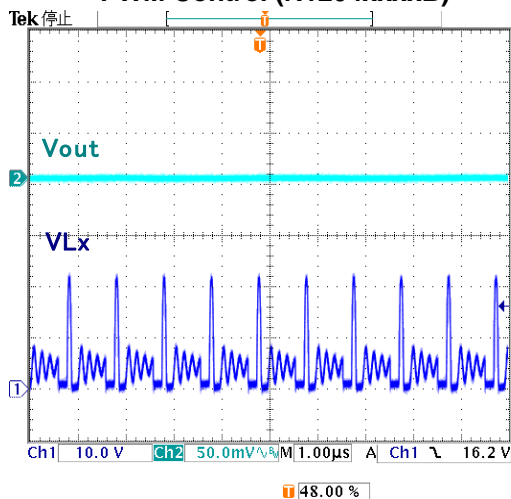

VFM Control (R1204xxxxC)

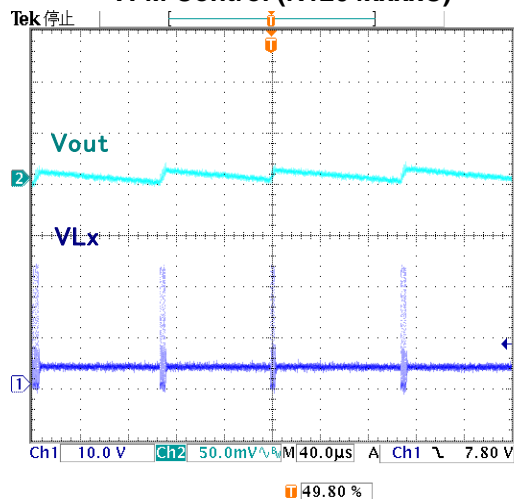

## 6) Load Transient Response

( $V_{IN}=3.6V$ ,  $V_{SET}=25V$ ,  $L=10\mu H$  (VLF302512MT-100M),  $I_{OUT}=10mA \leftrightarrow 30mA$ ,  $T_r=T_f=0.5\mu s$ )

R1204xxxxC

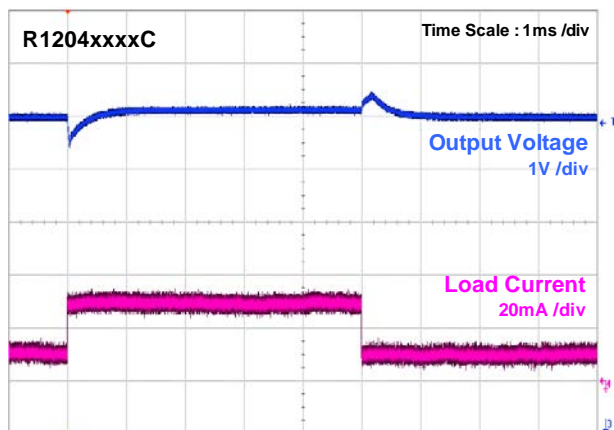

R1204xxxxF

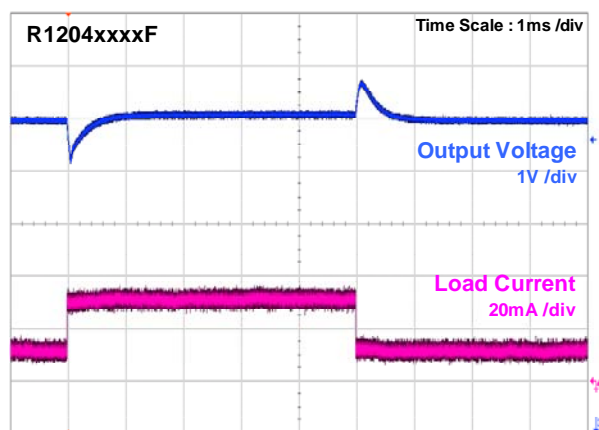

## 7) Supply Current vs. Ambient Temperature

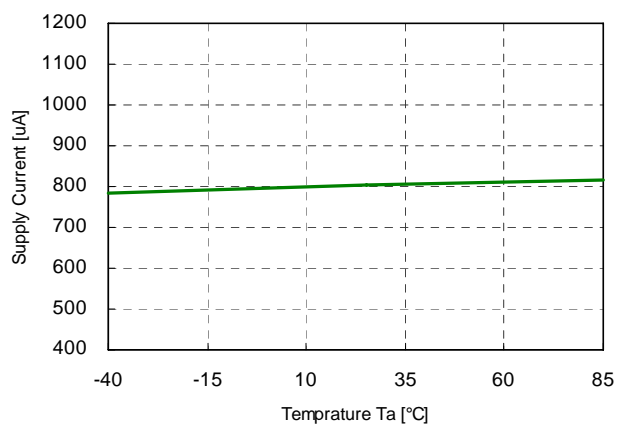

## 8) UVLO vs. Ambient Temperature

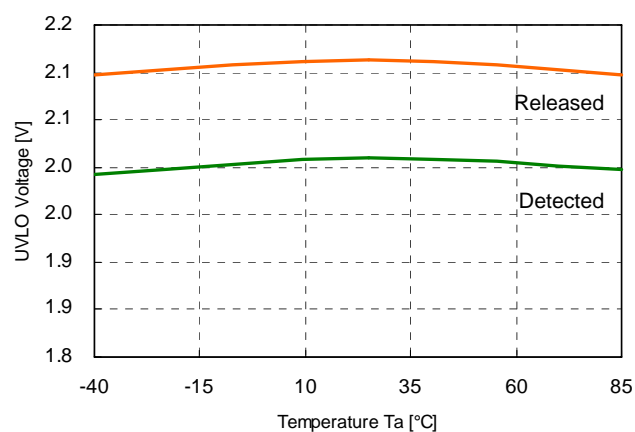

9)  $V_{FB}$  Voltage vs. Ambient Temperature

R1204xxxxA/D

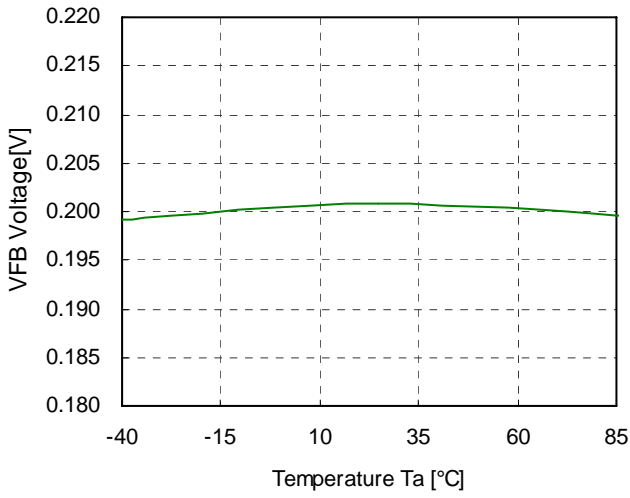

R1204xxxxG/H

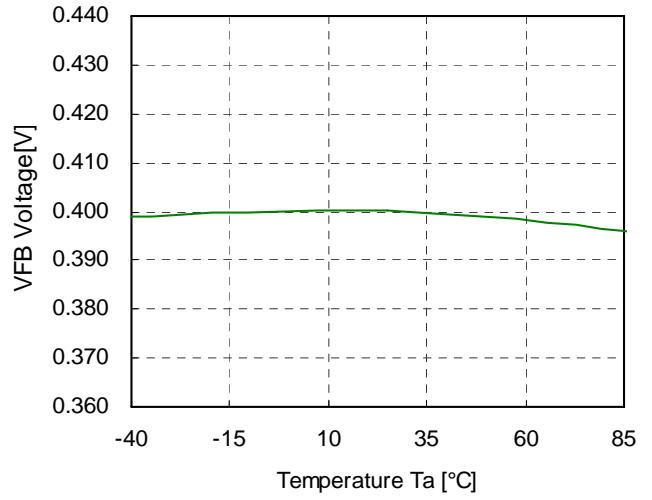

R1204xxxxB/C/E/F





**10) Switch ON Resistance vs. Ambient Temperature**



**11) OVP Voltage vs. Ambient Temperature R1204x3xxx**

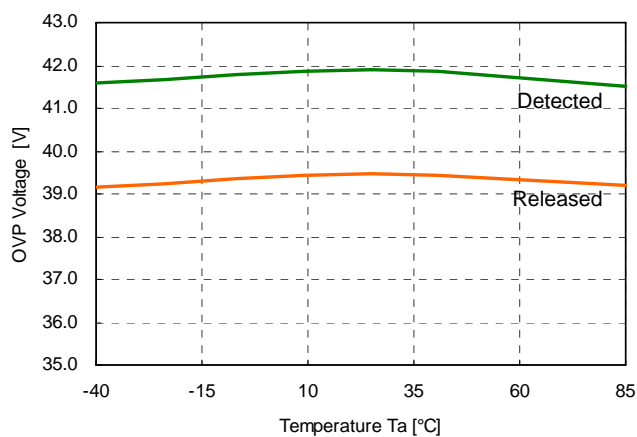

**12) L<sub>x</sub>Current Limit vs. Ambient Temperature**



**13) Oscillator Frequency vs. Ambient Temperature R1204xxxxA/B/C/G**



**R1204xxxxD/E/F/H**

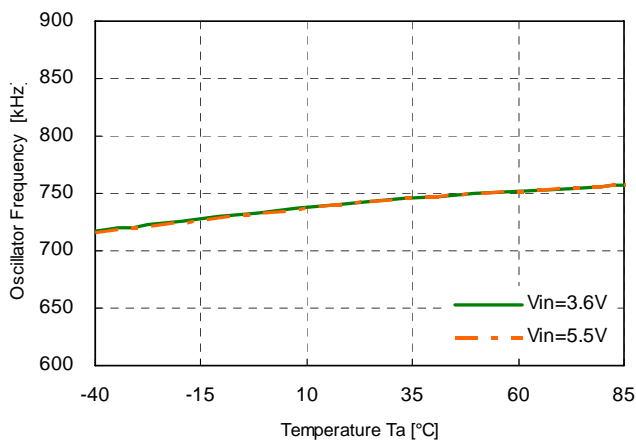



1. The products and the product specifications described in this document are subject to change or discontinuation of production without notice for reasons such as improvement. Therefore, before deciding to use the products, please refer to Ricoh sales representatives for the latest information thereon.
2. The materials in this document may not be copied or otherwise reproduced in whole or in part without prior written consent of Ricoh.
3. Please be sure to take any necessary formalities under relevant laws or regulations before exporting or otherwise taking out of your country the products or the technical information described herein.
4. The technical information described in this document shows typical characteristics of and example application circuits for the products. The release of such information is not to be construed as a warranty of or a grant of license under Ricoh's or any third party's intellectual property rights or any other rights.
5. The products listed in this document are intended and designed for use as general electronic components in standard applications (office equipment, telecommunication equipment, measuring instruments, consumer electronic products, amusement equipment etc.). Those customers intending to use a product in an application requiring extreme quality and reliability, for example, in a highly specific application where the failure or misoperation of the product could result in human injury or death (aircraft, spacevehicle, nuclear reactor control system, traffic control system, automotive and transportation equipment, combustion equipment, safety devices, life support system etc.) should first contact us.
6. We are making our continuous effort to improve the quality and reliability of our products, but semiconductor products are likely to fail with certain probability. In order to prevent any injury to persons or damages to property resulting from such failure, customers should be careful enough to incorporate safety measures in their design, such as redundancy feature, fire containment feature and fail-safe feature. We do not assume any liability or responsibility for any loss or damage arising from misuse or inappropriate use of the products.
7. Anti-radiation design is not implemented in the products described in this document.
8. Please contact Ricoh sales representatives should you have any questions or comments concerning the products or the technical information.



**Ricoh is committed to reducing the environmental loading materials in electrical devices with a view to contributing to the protection of human health and the environment.**

Ricoh has been providing RoHS compliant products since April 1, 2006 and Halogen-free products since April 1, 2012.

**RICOH** RICOH ELECTRONIC DEVICES CO., LTD.

<http://www.e-devices.ricoh.co.jp/en/>

#### Sales & Support Offices

##### **RICOH ELECTRONIC DEVICES CO., LTD.**

**Higashi-Shinagawa Office (International Sales)**  
3-32-3, Higashi-Shinagawa, Shinagawa-ku, Tokyo 140-8655, Japan  
Phone: +81-3-5479-2857 Fax: +81-3-5479-0502

##### **RICOH EUROPE (NETHERLANDS) B.V.**

**Semiconductor Support Centre**  
Prof. W.H. Keesomlaan 1, 1183 DJ Amstelveen, The Netherlands  
Phone: +31-20-5474-309

##### **RICOH ELECTRONIC DEVICES KOREA CO., LTD.**

3F, Haesung Bldg. 504, Teheran-ro, Gangnam-gu, Seoul, 135-725, Korea  
Phone: +82-2-2135-5700 Fax: +82-2-2051-5713

##### **RICOH ELECTRONIC DEVICES SHANGHAI CO., LTD.**

Room 403, No.2 Building, No.690 Bilbo Road, Pu Dong New District, Shanghai 201203,  
People's Republic of China  
Phone: +86-21-5027-3200 Fax: +86-21-5027-3299

##### **RICOH ELECTRONIC DEVICES CO., LTD.**

**Taipei office**  
Room 109, 10F-1, No.51, Hengyang Rd., Taipei City, Taiwan (R.O.C.)  
Phone: +886-2-2313-1621/1622 Fax: +886-2-2313-1623

# Mouser Electronics

Authorized Distributor

Click to View Pricing, Inventory, Delivery & Lifecycle Information:

[Ricoch Electronics:](#)

[R1204N213G-TR-FE](#) [R1204N213H-TR-FE](#) [R1204K212D-TR](#) [R1204K212F-TR](#)

## Данный компонент на территории Российской Федерации

### Вы можете приобрести в компании MosChip.

Для оперативного оформления запроса Вам необходимо перейти по данной ссылке:

<http://moschip.ru/get-element>

Вы можете разместить у нас заказ для любого Вашего проекта, будь то серийное производство или разработка единичного прибора.

В нашем ассортименте представлены ведущие мировые производители активных и пассивных электронных компонентов.

Нашей специализацией является поставка электронной компонентной базы двойного назначения, продукции таких производителей как XILINX, Intel (ex.ALTERA), Vicor, Microchip, Texas Instruments, Analog Devices, Mini-Circuits, Amphenol, Glenair.

Сотрудничество с глобальными дистрибьюторами электронных компонентов, предоставляет возможность заказывать и получать с международных складов практически любой перечень компонентов в оптимальные для Вас сроки.

На всех этапах разработки и производства наши партнеры могут получить квалифицированную поддержку опытных инженеров.

Система менеджмента качества компании отвечает требованиям в соответствии с ГОСТ Р ИСО 9001, ГОСТ РВ 0015-002 и ЭС РД 009

### Офис по работе с юридическими лицами:

105318, г.Москва, ул.Щербаковская д.3, офис 1107, 1118, ДЦ «Щербаковский»

Телефон: +7 495 668-12-70 (многоканальный)

Факс: +7 495 668-12-70 (доб.304)

E-mail: [info@moschip.ru](mailto:info@moschip.ru)

Skype отдела продаж:

moschip.ru

moschip.ru\_4

moschip.ru\_6

moschip.ru\_9