

Powered by



EVX 1272 ▶ 12V 7.2Ah

EVX 1272 is designed specially for electric vehicles, such as electric golf cart, electric wheelchair, mower, dust collector...etc. It has high cycling life, high efficiency and long service life.



► Specification

Cells Per Unit	6
Voltage Per Unit	12
Capacity	7.2Ah @ 20hr-rate to 1.75V per cell @25°C (77°F)
Weight	Approx. 2.55 kg (5.62 lbs)
Maximum Discharge Current	100A/130A(5sec)
Internal Resistance	Approx. 26 mΩ
Operating Temperature Range	Discharge: -15°C~50°C (5°F~122°F) Charge: -15°C~40°C (5°F~104°F) Storage: -15°C~40°C (5°F~104°F)
Nominal Operating Temperature Range	25°C±3°C (77°F±5°F)
Float Charging Voltage	13.5 to 13.8 VDC/unit Average at 25°C (77°F)
Recommended Maximum Charging Current Limit	2.16A
Equalization and Cycle Service	14.4 to 15.0 VDC/unit Average at 25°C (77°F)
Self Discharge	CSB Batteries can be stored for more than 6 months at 25°C (77°F). Please charge batteries before using. For higher temperatures the time interval will be shorter.
Terminal	F1/F2-Faston Tab187/250
Container Material	ABS(UL 94-HB/File E50263)*Flammability resistance of (UL 94-V0/File E88637) can be available upon request.



MH14533(N)



ISO9001
No.:041005117



ISO 14001
NO.UM 1-12-0045

CSB-manufactured VRLA batteries are UL-recognized components under UL924 and UL1989.

CSB is also certified by ISO 9001 and ISO 14001.

► Dimensions :

Overall Height (H)	Container height (h)	Length (L)	Width (W)
Unit: mm (inch)	100±1 (3.94±0.04)	151±2 (5.94±0.08)	65±1 (2.56±0.04)

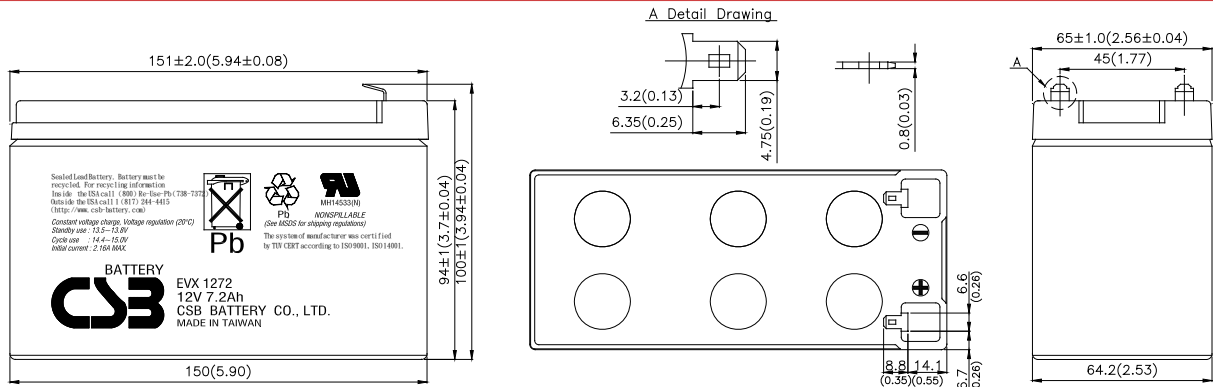

Constant Current Discharge Characteristics Unit:A (25°C, 77°F)

F.V/Time	30MIN	60MIN	90MIN	2HR	3HR	4HR	5HR	8HR	10HR	20HR
1.60V	7.01	4.19	3.08	2.49	1.79	1.44	1.20	0.820	0.680	0.395
1.67V	6.79	4.04	2.98	2.40	1.73	1.39	1.16	0.785	0.652	0.381
1.70V	6.57	3.91	2.89	2.34	1.68	1.36	1.13	0.770	0.640	0.375
1.75V	6.38	3.80	2.81	2.27	1.63	1.32	1.10	0.745	0.620	0.360
1.80V	6.20	3.70	2.73	2.19	1.58	1.28	1.07	0.720	0.600	0.345
1.85V	6.00	3.58	2.65	2.13	1.53	1.24	1.04	0.695	0.580	0.330

Constant Power Discharge Characteristics Unit:W (25°C, 77°F)

F.V/Time	30MIN	60MIN	90MIN	2HR	3HR	4HR	5HR	8HR	10HR	20HR
1.60V	84.1	50.3	37.0	29.6	21.5	17.3	14.4	9.81	8.20	4.53
1.67V	81.4	48.8	35.8	28.8	20.9	16.8	14.0	9.50	7.86	4.35
1.70V	79.2	47.3	34.8	27.9	20.2	16.3	13.6	9.24	7.72	4.27
1.75V	76.8	45.9	33.8	27.1	19.6	15.8	13.2	8.96	7.49	4.14
1.80V	74.4	44.4	32.7	26.2	19.0	15.3	12.8	8.67	7.25	4.00
1.85V	72.0	43.0	31.7	25.4	18.4	14.8	12.4	8.39	7.02	3.87

Trickle (or Float) Service Life

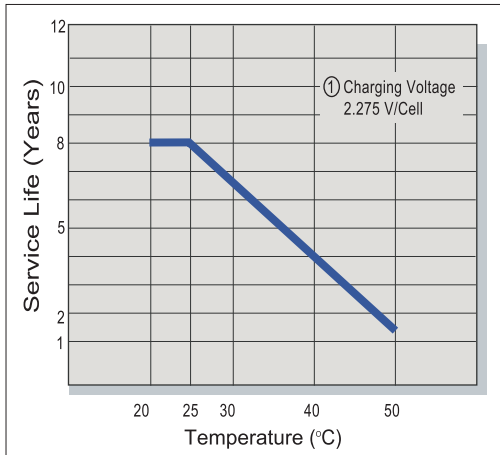

Capacity Retention Characteristic

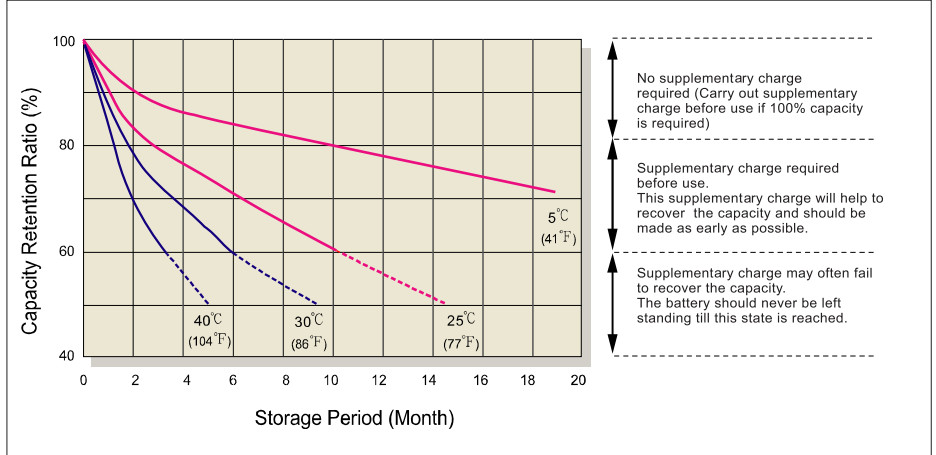

Battery Voltage and Charge Time for Standby Use

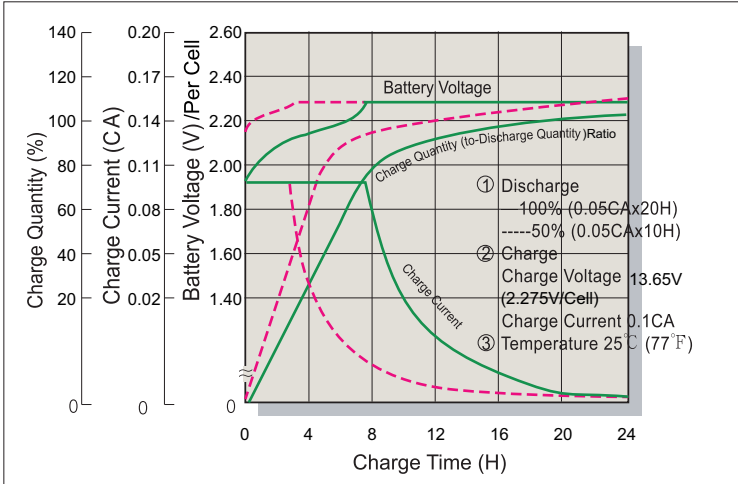

Series Cycle Service Life

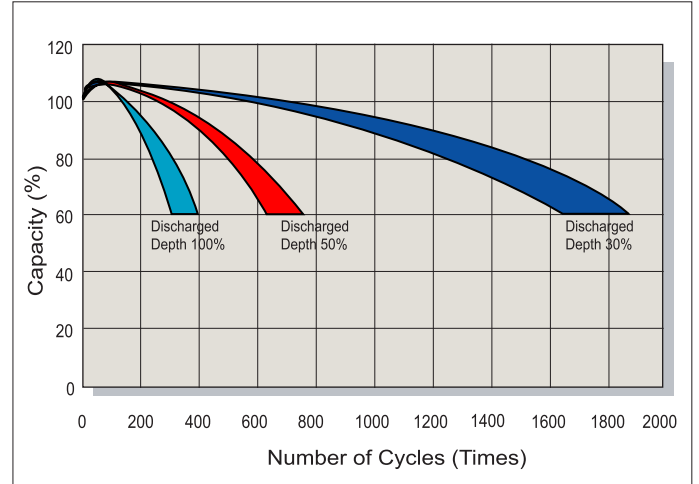

Battery Voltage and Charge Time for Cycle Use

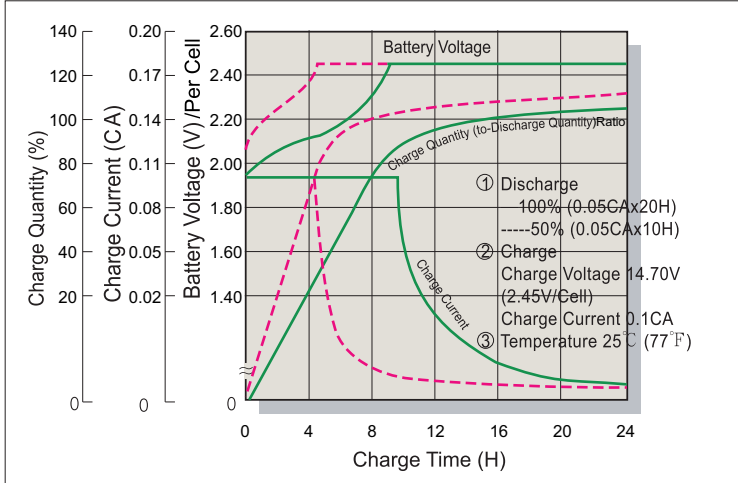

Terminal Voltage (V) and Discharge Time

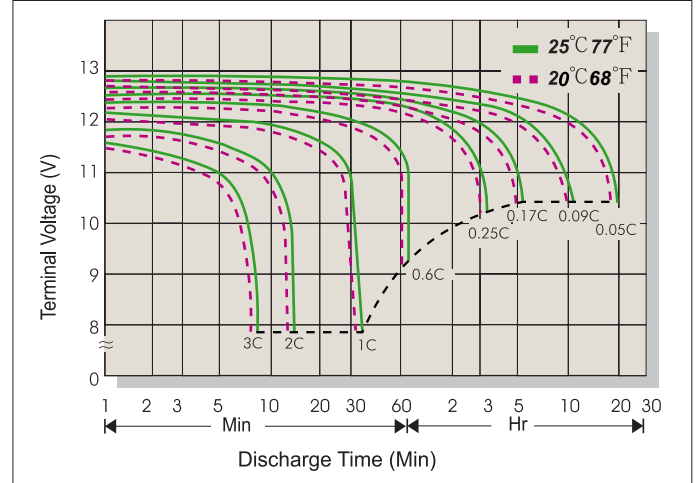

Charging Procedures

Application	Charge Voltage(V/Cell)			Max.Charge Current
	Temperature	Set Point	Allowable Range	
Cycle Use	25°C(77°F)	2.45	2.40~2.50	0.3C
Standby	25°C(77°F)	2.275	2.25~2.30	

Discharge Current VS. Discharge Voltage

Final Discharge Voltage V/Cell	1.75	1.70	1.60	1.30
Discharge Current(A)	0.2C>(A)	0.2C<(A)<0.5C	0.5C<(A)<1.0C	(A)>1.0C

Sales Office URL: WWW.CSB-BATTERY.COM

GLOBAL HQ
CSB BATTERY CO., LTD. (TAIWAN)
 Tel : +886-2-2555-5600
 Fax : +886-2-2555-3300
 mail : service@csb-battery.com.tw

BEIJING OFFICE. (CHINA)
CSB BATTERY TECHNOLOGIES (BEIJING) CO., LTD.
 Tel : +86-10-59621300/1301/1302/1303
 Fax : +86-10-59621304
 mail : chinasl@csb-battery.com

AMERICA HQ
CSB BATTERY TECHNOLOGIES INC. (U.S.A)
 Tel : +1-817-244-7777/1-(800)3-CSB-USA(272872)
 Fax : +1-817-244-4445
 mail : csb@csb-battery.com

SHANGHAI OFFICE. (CHINA)
CSB BATTERY LOGISTIC (SHANGHAI) CO., LTD.
 Tel : +86-21-5046-1622/5046-0833
 Fax : +86-21-5064-3314
 mail : chinasl@csb-battery.com

EUROPE HQ
CSB Battery Europe BV.
 Tel : +31(0)-180-418-140
 Fax : +886-2-2555-3300
 mail : eurosales@csb-battery.eu

SHENZHEN OFFICE. (CHINA)
CSB BATTERY LOGISTIC (SHANGHAI) CO., LTD.
 Tel : +86-755-8831-6488/6396/6356
 Fax : +86-755-8831-6548
 mail : she@csb-battery.com.cn

Данный компонент на территории Российской Федерации

Вы можете приобрести в компании MosChip.

Для оперативного оформления запроса Вам необходимо перейти по данной ссылке:

<http://moschip.ru/get-element>

Вы можете разместить у нас заказ для любого Вашего проекта, будь то серийное производство или разработка единичного прибора.

В нашем ассортименте представлены ведущие мировые производители активных и пассивных электронных компонентов.

Нашей специализацией является поставка электронной компонентной базы двойного назначения, продукции таких производителей как XILINX, Intel (ex.ALTERA), Vicor, Microchip, Texas Instruments, Analog Devices, Mini-Circuits, Amphenol, Glenair.

Сотрудничество с глобальными дистрибьюторами электронных компонентов, предоставляет возможность заказывать и получать с международных складов практически любой перечень компонентов в оптимальные для Вас сроки.

На всех этапах разработки и производства наши партнеры могут получить квалифицированную поддержку опытных инженеров.

Система менеджмента качества компании отвечает требованиям в соответствии с ГОСТ Р ИСО 9001, ГОСТ РВ 0015-002 и ЭС РД 009

Офис по работе с юридическими лицами:

105318, г.Москва, ул.Щербаковская д.3, офис 1107, 1118, ДЦ «Щербаковский»

Телефон: +7 495 668-12-70 (многоканальный)

Факс: +7 495 668-12-70 (доб.304)

E-mail: info@moschip.ru

Skype отдела продаж:

moschip.ru

moschip.ru_4

moschip.ru_6

moschip.ru_9