

### General Description

Qorvo's RFUV1703 is a 21 GHz to 26.5 GHz GaAs pHEMT upconverter, incorporating an integrated doubler, LO buffer amplifier, a balanced single sideband (image rejection) mixer followed by Variable Gain Amplifier, DC decoupling capacitors. The combination of high performance part and low-cost packaging makes the RFUV1703 a cost effective solution, ideally suited to both current and next generation point-to-point and  $V_{SAT}$  applications. RFUV1703 is packaged in a 5 mm x 5 mm QFN to simplify both system level board design and volume assembly.

Lead-free and RoHS compliant

### Functional Block Diagram

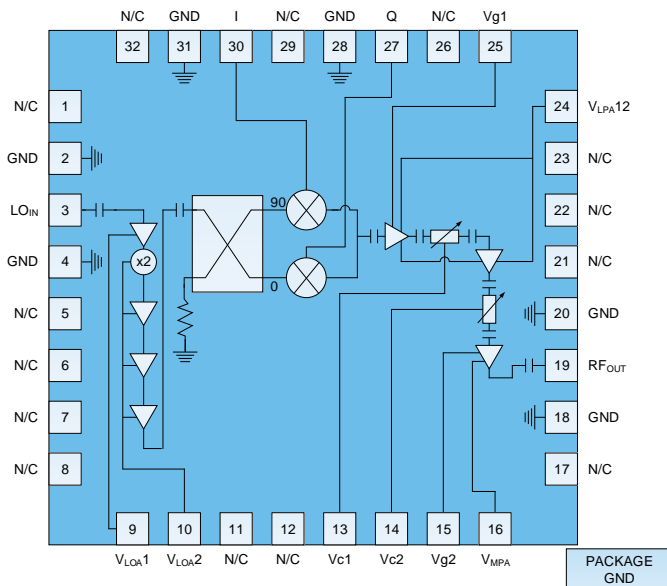

Package: QFN, 32 Pin, 5 mm x 5 mm x 0.95 mm

### Product Features

- RF Frequency: 21 GHz to 26.5 GHz
- LO Frequency (LSB): 10.5 GHz to 15.2 GHz
- LO Frequency (USB): 8.5 GHz to 13.25 GHz
- IF Frequency: DC to 4 GHz
- Conversion Gain (Max): 21 dB
- Conversion Gain (Min): -10 dB
- NF (Max. Gain): 12 dB
- OIP3 (Max. Gain): +27 dBm
- Image Rejection: 15 dBc

*Performance is typical across frequency. Please reference electrical specification table and data plots for more details.*

### Applications

- Point-to-Point
- $V_{SAT}$

### Ordering Information

Part	Description
RFUV1703S2	2-Piece Sample Bag
RFUV1703SB	5-Piece Bag
RFUV1703SQ	25-Piece Bag
RFUV1703SR	100 Pieces on 7" reel
RFUV1703TR7	750 Pieces on 7" reel
RFUV1703PCBA-410	Evaluation Board

## Absolute Maximum Ratings

Parameter	Rating	Unit
LPA Drain Voltage $V_D$	6	V
LOA Drain Voltage	6	V
IF Input Power	15	dBm
LO Input Power	15	dBm
Storage Temperature	-65 to +150	°C

Exceeding any one or a combination of the Absolute Maximum Rating conditions may cause permanent damage to the device. Extended application of Absolute Maximum Rating conditions to the device may reduce device reliability.

## Nominal Operating Parameters

Parameter	Specification			Units	Condition
	Min	Typical	Max		
RF Frequency	21		26.5	GHz	
LO Frequency: LSB	10.5		15.25	GHz	
LO Frequency: USB	8.5		13.25	GHz	
IF Frequency	DC	2.5	4.0	GHz	
LO input Drive		0		dBm	
Conversion Gain (Max.) (USB)	19	21		dB	LO = 9.95 GHz & 11.5 GHz
Conversion Gain (Min.) (USB)	-5.5	-5		dB	LO = 9.95 GHz & 11.5 GHz
OIP3 (Max. Gain) (USB)	23.5	29		dBm	LO = 9.95 GHz
OIP3 (-5 dB Gain) (USB)	0.5	6.5		dBm	LO = 9.95 GHz
OIP3 (Max. Gain) (USB)	20.5	27		dBm	LO = 11.5 GHz
OIP3 (-5 dB Gain) (USB)	4	9		dBm	LO = 11.5 GHz
Image Rejection (Max. Gain) (USB)	15	20		dBc	LO = 9.95 GHz
Image Rejection (Max. Gain) (USB)	14	20		dBc	LO = 11.5 GHz
LO Leakage @ RF-Port (Max. Gain) (USB)		-10	5	dBm	LO = 9.95 GHz
LO Leakage @ RF-Port (Max. Gain) (USB)		1	7.5	dBm	LO = 11.5 GHz
NF (Max. Gain)		12		dB	
LO Return Loss		10		dB	
RF Return Loss		10		dB	
$V_{LOA}$		4		V	
$V_{LPA}$		3.5		V	
$V_{MOA}$		4.5		V	
$I_{LOA}$		205		mA	
$I_{LOA1,2}$		120		mA	
$I_{MPA}$		120		mA	
$I_{TOTAL}$		445		mA	
$V_{C1}, V_{C2}$	-4		0	V	
Operating Temperature	-55	25	85	°C	

## Performance Plots – USB Conversion

Measurements performed with I and Q (IF) ports connected to an external 90° Hybrid

Test conditions unless otherwise noted: LO Power = 0 dBm and IF = 2.5 GHz, -10 dBm

$V_{LOA1} = V_{LOA2} = 4\text{ V}$ ,  $I_{LOA1,2} = 205\text{ mA}$ ;  $V_{LPA12} = 3.5\text{ V}$ , Adjust  $V_{G1}$  around  $-0.4\text{ V}$  to get  $I_{LPA12} = 120\text{ mA}$

$V_{MPA} = 4.5\text{ V}$ , Adjust  $V_{G2}$  to get  $I_{MPA} = 120\text{ mA}$ ,  $I_{TOTAL} = 445\text{ mA}$ ,  $V_{C1} = V_{C2} = -4\text{ V}$

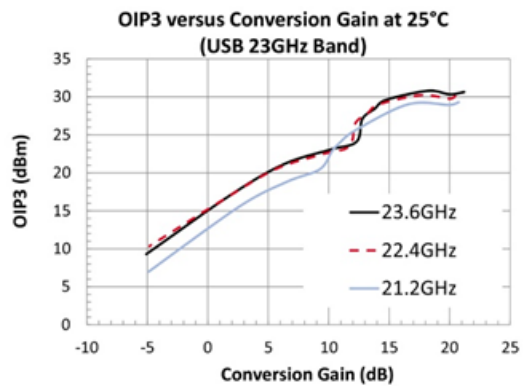
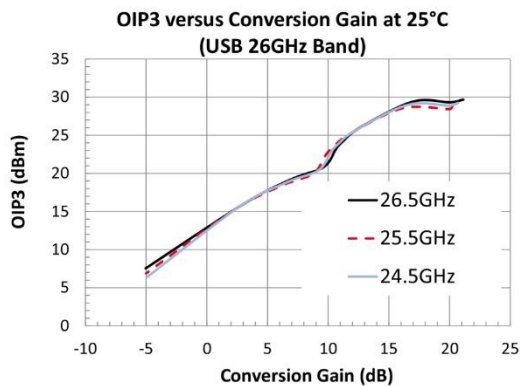
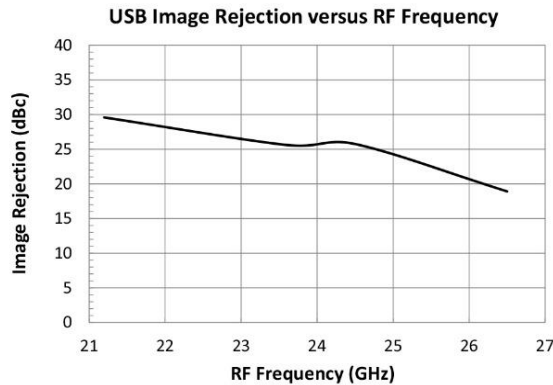
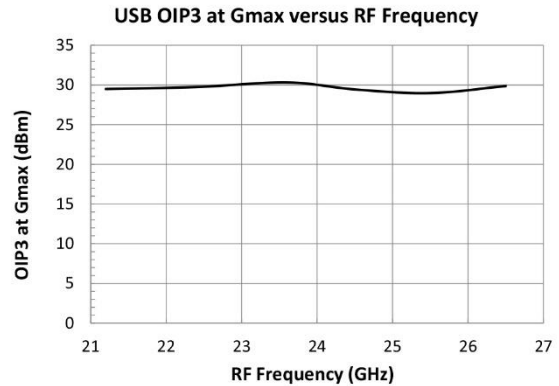
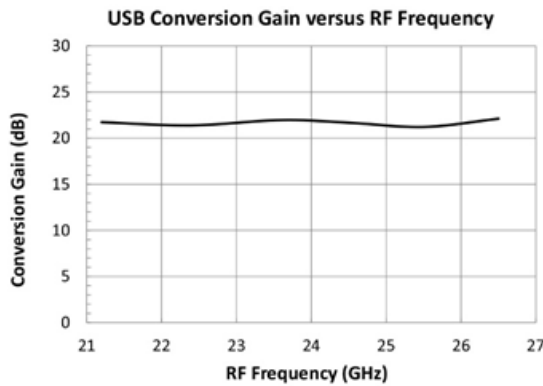

## Performance Plots – USB LO Leakage & Over Temperature

Measurements performed with I and Q (IF) ports connected to an external 90° Hybrid

Test conditions unless otherwise noted: LO Power = 0 dBm and IF = 2.5 GHz, -10 dBm

$V_{LOA1} = V_{LOA2} = 4\text{ V}$ ,  $I_{LOA1,2} = 205\text{ mA}$ ;  $V_{LPA12} = 3.5\text{ V}$ , Adjust  $V_{G1}$  around  $-0.4\text{ V}$  to get  $I_{LPA12} = 120\text{ mA}$

$V_{MPA} = 4.5\text{ V}$ , Adjust  $V_{G2}$  to get  $I_{MPA} = 120\text{ mA}$ ,  $I_{TOTAL} = 445\text{ mA}$ ,  $V_{C1} = V_{C2} = -4\text{ V}$

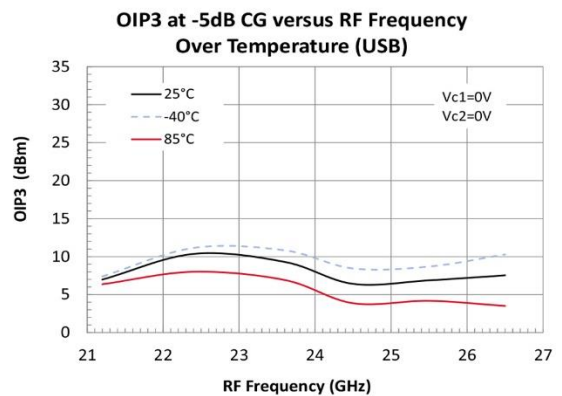
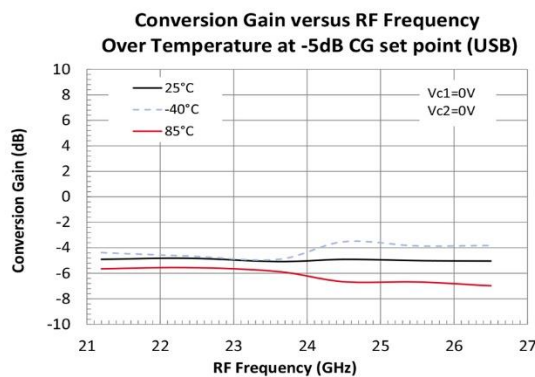
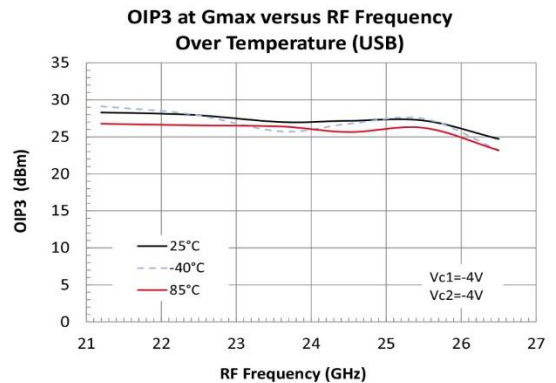
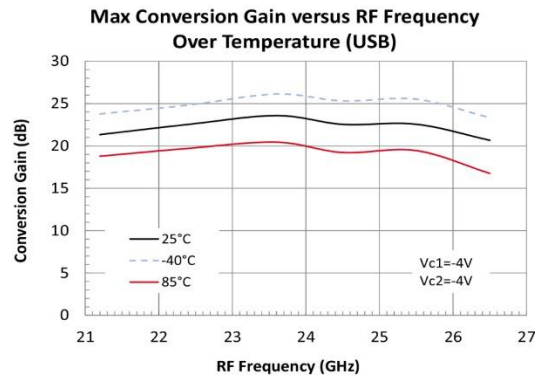
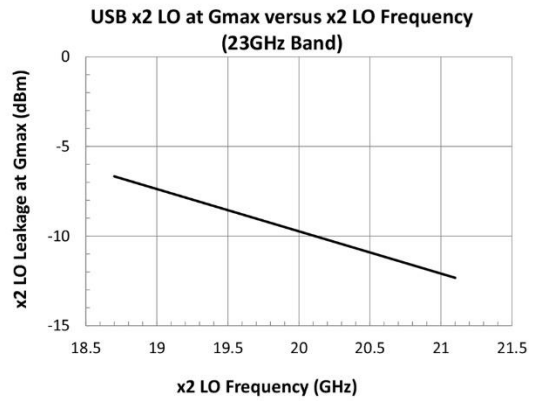
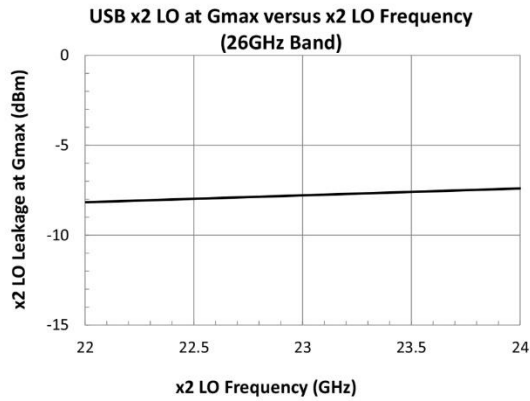

## Performance Plots – LSB Conversion & LO Leakage

Measurements performed with I and Q (IF) ports connected to an external 90° Hybrid

Test conditions unless otherwise noted: LO Power = 0 dBm and IF = 2.5 GHz, -10 dBm

$V_{LOA1} = V_{LOA2} = 4\text{ V}$ ,  $I_{LOA1,2} = 205\text{ mA}$ ;  $V_{LPA12} = 3.5\text{ V}$ , Adjust  $V_{G1}$  around  $-0.4\text{ V}$  to get  $I_{LPA12} = 120\text{ mA}$

$V_{MPA} = 4.5\text{ V}$ , Adjust  $V_{G2}$  to get  $I_{MPA} = 120\text{ mA}$ ,  $I_{TOTAL} = 445\text{ mA}$ ,  $V_{C1} = V_{C2} = -4\text{ V}$

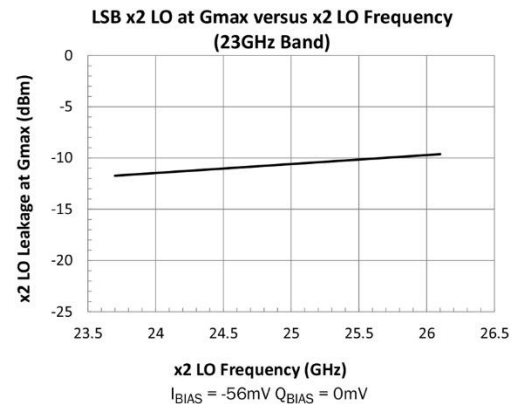
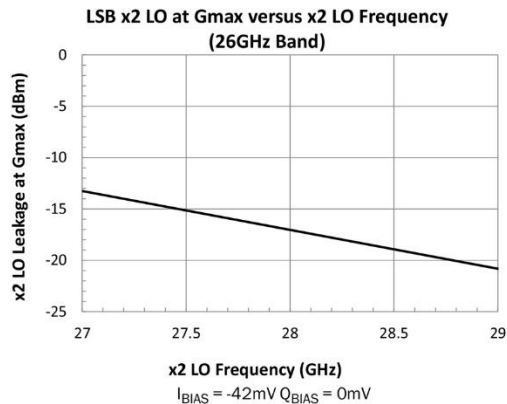
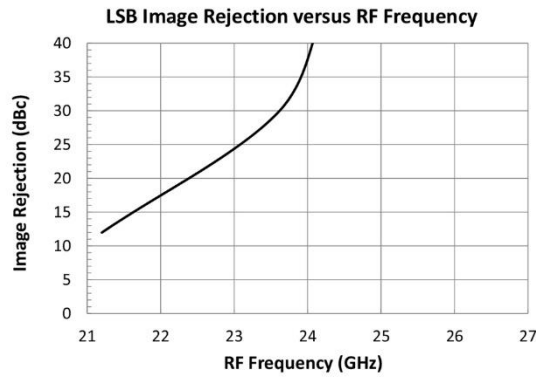
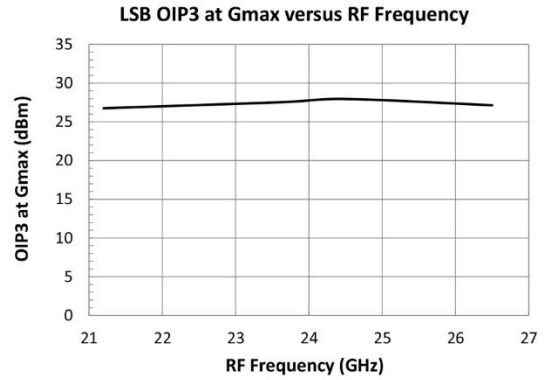
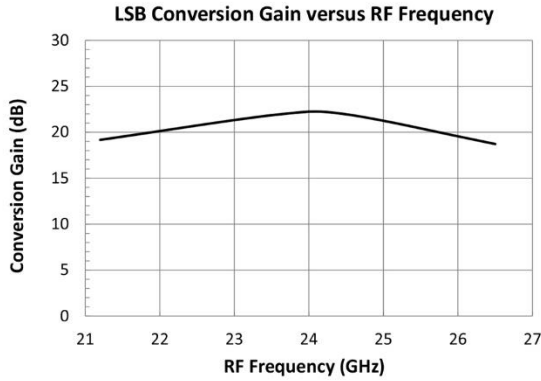

## Performance Plots – USB: Without IQ Bias

Measurements performed with I and Q (IF) ports connected to an external 90° Hybrid

Test conditions unless otherwise noted: LO Power = 0 dBm and IF = 2.5 GHz, -10 dBm

$V_{MPA} = 4.5\text{ V}$ ,  $V_{LPA12} = 3.5\text{ V}$ ,  $V_{LOA1} = V_{LOA2} = 4\text{ V}$ ,  $I_{TOTAL} = 445\text{ mA}$ ,  $V_{G1} = V_{G2} = -0.4\text{ V}$

$V_{C1}$  and  $V_{C2}$  are connected together off chip and changes over (-4 V to 0 V): **Single Control Bias**

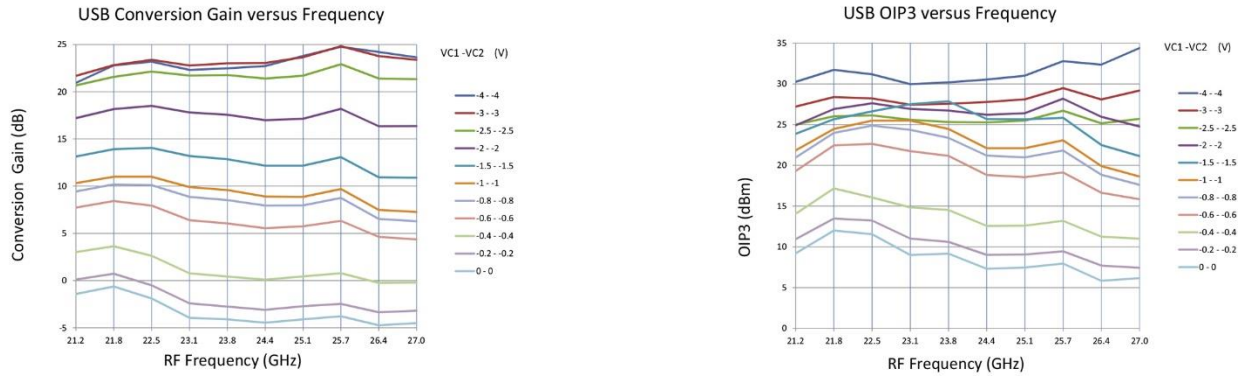

$V_{MPA} = 4.5\text{ V}$ ,  $V_{LPA12} = 3.5\text{ V}$ ,  $V_{LOA1} = V_{LOA2} = 4\text{ V}$ ,  $I_{TOTAL} = 445\text{ mA}$ ,  $V_{G1} = V_{G2} = -0.4\text{ V}$

$V_{C1}$  and  $V_{C2}$  are separated controlled and changes over (-4 V to 0 V): **Double Control Bias**

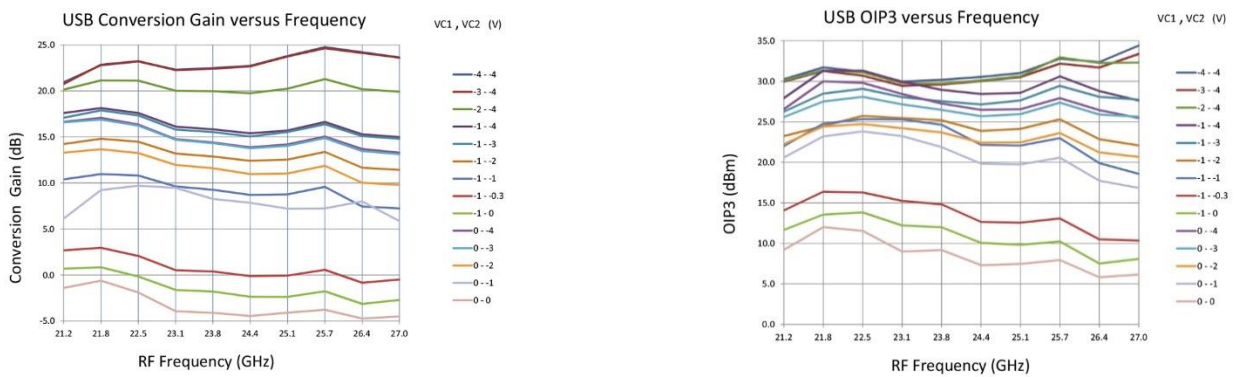

### Performance Plots – USB: Without IQ Bias (continued)

Measurements performed with I and Q (IF) ports connected to an external 90° Hybrid

Test conditions unless otherwise noted: LO Power = 0 dBm and IF = 2.5 GHz, -10 dBm

$V_{MPA} = 4.5\text{ V}$ ,  $V_{LPA12} = 3.5\text{ V}$ ,  $V_{LOA1} = V_{LOA2} = 4\text{ V}$ ,  $V_{C1} = V_{C2} = -4\text{ V}$

$V_{G1}$  and  $V_{G2}$  are connected together off chip and changes over (-0.3 V to -1 V): **Single Control on  $V_{G1} = V_{G2}$**

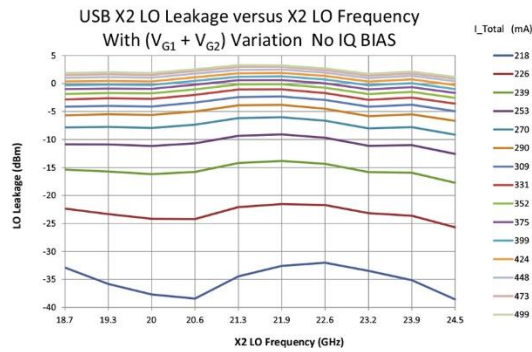
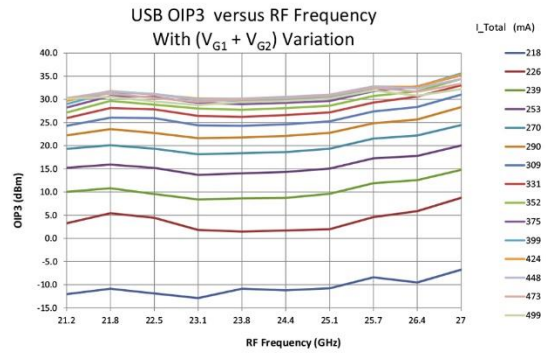
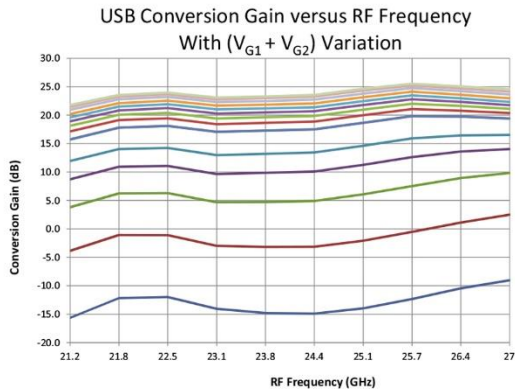

Application Circuit Block Diagram

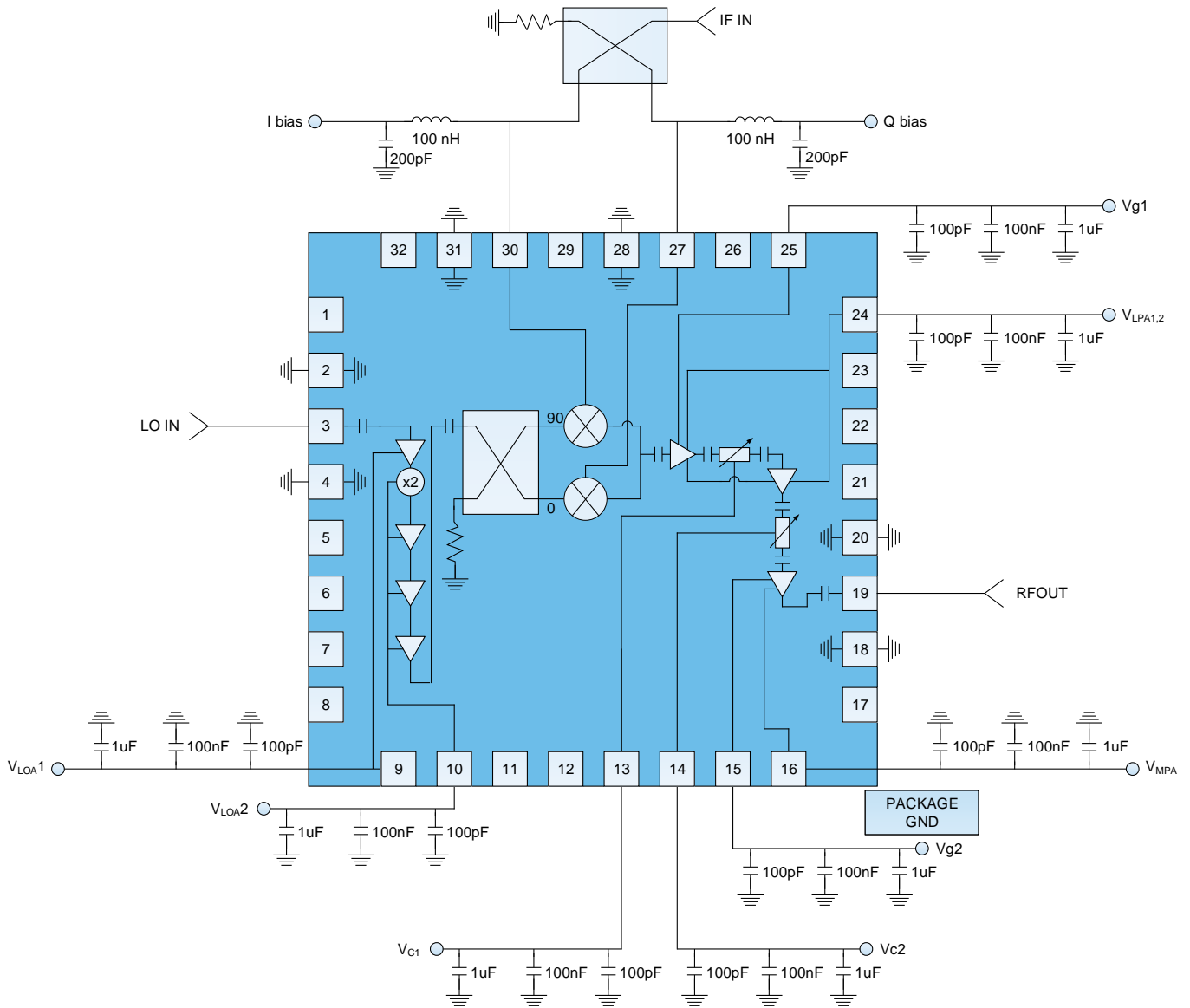

$2 * LO - IF = RF$  (LSB), LO = 10.5 to 15.25 GHz

$2 * LO + IF = RF$  (USB), LO = 8.5 GHz to 13.25 GHz

Notes:

1. External components for IQ biases are required.
2. External hybrid coupler is required.



## Evaluation Board Layout

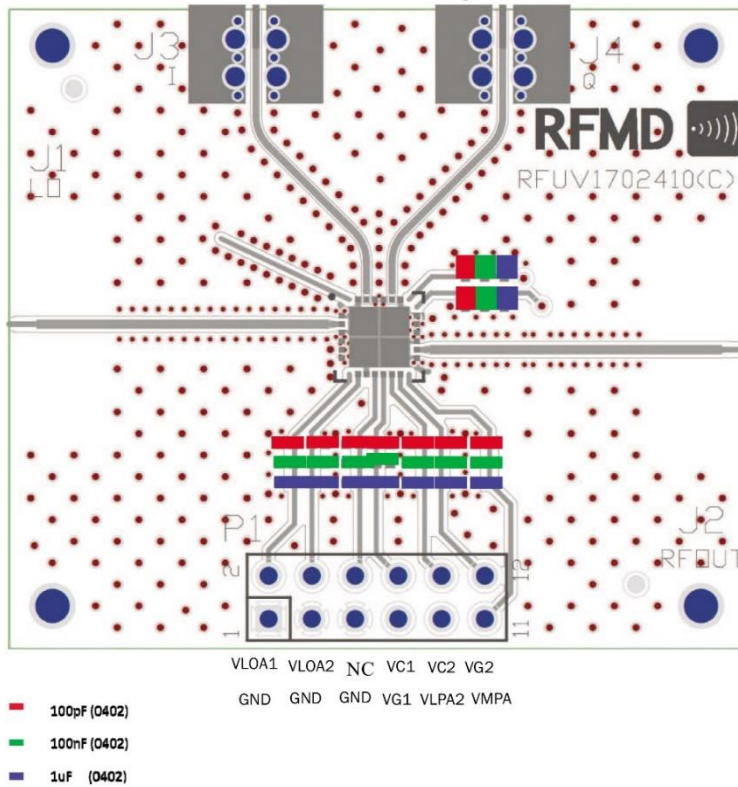

## Sub-Band Frequency Ranges

Band	Frequency Range
23 GHz	21.2 GHz to 23.6 GHz
26 GHz	24.5 GHz to 26.5 GHz

## Test Conditions and Bias Sequence

Measurements performed with I and Q (IF) ports connected to an external 90° Hybrid, LO Power = 0 dBm and IF = 2.5 GHz, -10 dBm, unless otherwise stated.

$V_{LOA1} = V_{LOA2} = 4\text{ V}$ ,  $I_{LOA1,2} = 205\text{ mA}$ ;  $V_{LPA12} = 3.5\text{ V}$ , Adjust  $V_{G1}$  around  $-0.4\text{ V}$  to get  $I_{LPA12} = 120\text{ mA}$

$V_{MPA} = 4.5\text{ V}$ , Adjust  $V_{G2}$  to get  $I_{MPA} = 120\text{ mA}$ ,  $I_{TOTAL} = 445\text{ mA}$ ,  $V_{C1} = V_{C2} = -4\text{ V}$ .

Typical Bias Sequence							
	$G_{MAX}$						$G_{MIN}$
$V_{C1}$ (V)	-4	-2	-1	0	0	0	0
$V_{C2}$ (V)	-4	-4	-4	-4	-2	-1	0

More dynamic range can be achieved using  $V_{G2}$  over  $(-0.4\text{ to }-1\text{ V})$  and  $V_{G1}$  over  $(-0.4\text{ to }-1\text{ V})$

## Pin Names and Description

Pin Number	Label	Description
1	N/C	Not Connected
2	GND	Ground
3	LO	Local Oscillator Input. AC Coupled and Matched to 50 $\Omega$
4	GND	Ground
5	N/C	Not Connected
6	N/C	Not Connected
7	N/C	Not Connected
8	N/C	Not Connected
9	VLOA1	LOA Stage1 Drain Bias
10	VLOA2	LOA Stage2 Drain Bias
11	N/C	Not Connected
12	N/C	Not Connected
13	VC1	Control Line Number 1 (See Bias Sequence Description)
14	VC2	Control Line Number 2 (See Bias Sequence Description)
15	VG2	MPA Gate Bias
16	VMPA	MPA Drain Bias
17	N/C	Not Connected
18	GND	Ground
19	RFOUT	RF Output. AC Coupled and Matched to 50 $\Omega$
20	GND	Ground
21	N/C	Not Connected
22	N/C	Not Connected
23	N/C	Not Connected
24	VLPA1, VLPA2	LPA Stage 1, 2 Drain Bias
25	VG1	LPA Stage 1, 2 Gate Bias
26	N/C	Not Connected
27	Q	IF Q Input
28	GND	Ground
29	N/C	Not Connected
30	I	IF I Input
31	GND	Ground
32	N/C	Not Connected

## Package Marking and Dimensions

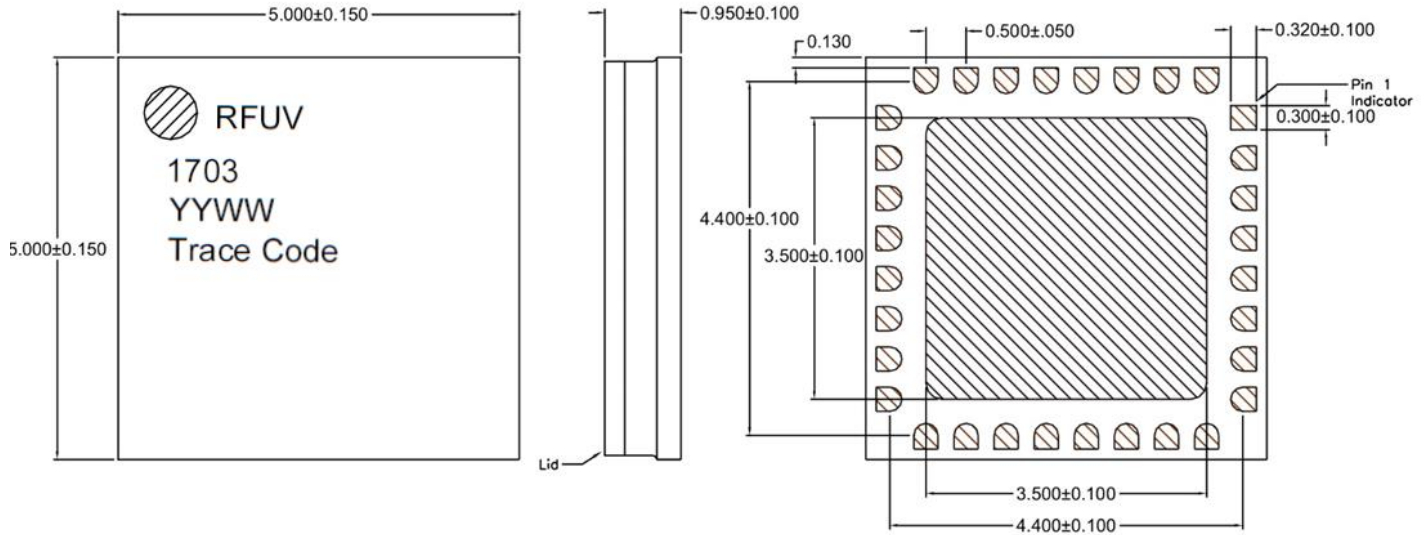

All dimensions are in millimeters

### Marking:

RFUV1703: Part number

YY: Part Assembly year

WW: Part Assembly week

Assembly Notes

Compatible with lead-free soldering processes with 260°C peak reflow temperature.

This package is air-cavity and non-hermetic, and therefore cannot be subjected to aqueous washing. The use of no-clean solder to avoid washing after soldering is highly recommended.

Contact plating: Ni-Au.

Solder rework not recommended.

Recommended Soldering Profile

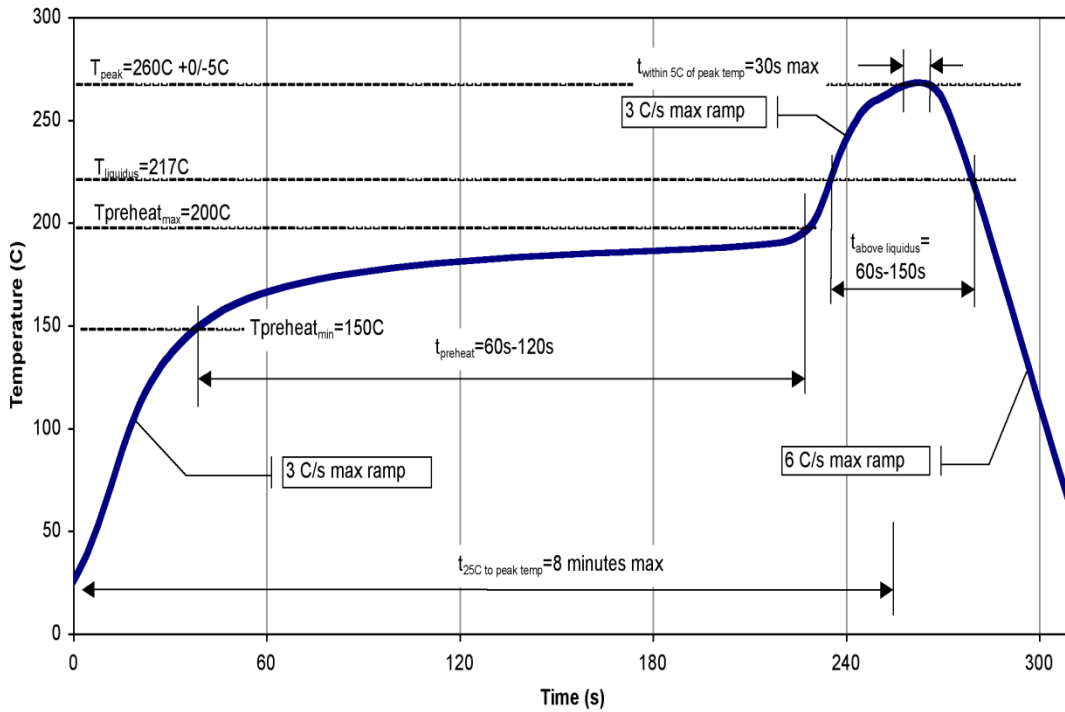

## Handling Precautions

Parameter	Rating	Standard
ESD – Human Body Model (HBM)	Class 1A	JESD22-A114
ESD – Charged Device Model (CDM)	Class C2	JESDE22-C101C
MSL – Convection Reflow 260 °C	Level 2	JEDEC standard IPC/JEDEC J-STD-020



Caution!  
ESD-Sensitive Device

## RoHS Compliance

This part is compliant with 2011/65/EU RoHS directive (Restrictions on the Use of Certain Hazardous Substances in Electrical and Electronic Equipment) as amended by Directive 2015/863/EU.

This product also has the following attributes:

- Lead Free
- Antimony Free
- TBBP-A (C<sub>15</sub>H<sub>12</sub>Br<sub>4</sub>O<sub>2</sub>) Free
- PFOS Free
- SVHC Free

## Contact Information

For the latest specifications, additional product information, worldwide sales and distribution locations:

**Web:** [www.qorvo.com](http://www.qorvo.com)

**Tel:** 1-844-890-8163

**Email:** [customer.support@qorvo.com](mailto:customer.support@qorvo.com)

## Important Notice

The information contained herein is believed to be reliable; however, Qorvo makes no warranties regarding the information contained herein and assumes no responsibility or liability whatsoever for the use of the information contained herein. All information contained herein is subject to change without notice. Customers should obtain and verify the latest relevant information before placing orders for Qorvo products. The information contained herein or any use of such information does not grant, explicitly or implicitly, to any party any patent rights, licenses, or any other intellectual property rights, whether with regard to such information itself or anything described by such information. **THIS INFORMATION DOES NOT CONSTITUTE A WARRANTY WITH RESPECT TO THE PRODUCTS DESCRIBED HEREIN, AND QORVO HEREBY DISCLAIMS ANY AND ALL WARRANTIES WITH RESPECT TO SUCH PRODUCTS WHETHER EXPRESS OR IMPLIED BY LAW, COURSE OF DEALING, COURSE OF PERFORMANCE, USAGE OF TRADE OR OTHERWISE, INCLUDING THE IMPLIED WARRANTIES OF MERCHANTABILITY AND FITNESS FOR A PARTICULAR PURPOSE.**

Without limiting the generality of the foregoing, Qorvo products are not warranted or authorized for use as critical components in medical, life-saving, or life-sustaining applications, or other applications where a failure would reasonably be expected to cause severe personal injury or death.

Copyright 2020 © Qorvo, Inc. | Qorvo is a registered trademark of Qorvo, Inc.

## Данный компонент на территории Российской Федерации

### Вы можете приобрести в компании MosChip.

Для оперативного оформления запроса Вам необходимо перейти по данной ссылке:

<http://moschip.ru/get-element>

Вы можете разместить у нас заказ для любого Вашего проекта, будь то серийное производство или разработка единичного прибора.

В нашем ассортименте представлены ведущие мировые производители активных и пассивных электронных компонентов.

Нашей специализацией является поставка электронной компонентной базы двойного назначения, продукции таких производителей как XILINX, Intel (ex.ALTERA), Vicor, Microchip, Texas Instruments, Analog Devices, Mini-Circuits, Amphenol, Glenair.

Сотрудничество с глобальными дистрибьюторами электронных компонентов, предоставляет возможность заказывать и получать с международных складов практически любой перечень компонентов в оптимальные для Вас сроки.

На всех этапах разработки и производства наши партнеры могут получить квалифицированную поддержку опытных инженеров.

Система менеджмента качества компании отвечает требованиям в соответствии с ГОСТ Р ИСО 9001, ГОСТ РВ 0015-002 и ЭС РД 009

### Офис по работе с юридическими лицами:

105318, г.Москва, ул.Щербаковская д.3, офис 1107, 1118, ДЦ «Щербаковский»

Телефон: +7 495 668-12-70 (многоканальный)

Факс: +7 495 668-12-70 (доб.304)

E-mail: [info@moschip.ru](mailto:info@moschip.ru)

Skype отдела продаж:

moschip.ru

moschip.ru\_4

moschip.ru\_6

moschip.ru\_9