



## Main

Range of product	OsiSense XT
Sensor type	Capacitive proximity sensor
Product specific application	Detection of insulated or conductive materials
Sensor name	XT2
Sensor design	Cylindrical M18
Size	78 mm
Body type	Fixed
Detector flush mounting acceptance	Non flush mountable
Material	Plastic
Enclosure material	Plastic
Type of output signal	Discrete
Wiring technique	3-wire
[Sn] nominal sensing distance	0.31 in (8 mm)
Discrete output function	1 NO
Output circuit type	DC
Discrete output type	NPN
Electrical connection	Cable
Cable length	6.56 ft (2 m)
[Us] rated supply voltage	12...24 V DC with reverse polarity protection
Delay response	< 15 ms
IP degree of protection	IP67 double insulation conforming to IEC 60529

## Complementary

ISO thread	M18 x 1
Detection face	Frontal
[Sa] assured operating distance	0...0.23 in (0...5.8 mm)
Adjustment zone	0...0.47 in (0...12 mm)
Differential travel	< 1...20 % Sr
Repeat accuracy	< 5 % Sr
Wire insulation material	PVC
Status LED	1 LED (yellow) output state indication
Supply voltage limits	10...30 V DC
Residual current	<= 100 mA (open state)
Protection type	Short-circuit protection
Switching frequency	<= 200 Hz
Voltage drop	< 2.5 V (closed)
Current consumption	< 15 mA
Delay first up	< 100 ms
Delay recovery	< 15 ms
Maximum switching current	200 mA
Marking	CE
Setting-up	Sensitivity by potentiometer
Threaded length	1.85 in (47 mm)
Length	3.07 in (78 mm)
Product weight	0.33 lb(US) (0.15 kg)

## Environment

standards	EN/IEC 60947-5-2
product certifications	CULus
ambient air temperature for operation	14...140 °F (-10...60 °C)
vibration resistance	10 gn amplitude = 1 mm (10...55 Hz) conforming to IEC 60068-2-6
shock resistance	30 gn (duration = 11 ms) conforming to IEC 60068-2-27
resistance to electrostatic discharge	4 kV (contact) conforming to IEC 61000-4-2 8 kV (air) conforming to IEC 61000-4-2
resistance to electromagnetic fields	2.74 V/yd (3 V/m) conforming to IEC 61000-4-3
resistance to fast transients	2 kV conforming to IEC 61000-4-4

## Offer Sustainability

Not Green Premium product	Not Green Premium product
Compliant - since 0918 - Schneider Electric declaration of conformity	Compliant - since 0918 - Schneider Electric declaration of conformity
WARNING: This product can expose you to chemicals including:	WARNING: This product can expose you to chemicals including:
Diisononyl phthalate (DINP), which is known to the State of California to cause cancer, and	Diisononyl phthalate (DINP), which is known to the State of California to cause cancer, and
Di-isodecyl phthalate (DIDP), which is known to the State of California to cause birth defects or other reproductive harm.	Di-isodecyl phthalate (DIDP), which is known to the State of California to cause birth defects or other reproductive harm.
For more information go to <a href="http://www.p65warnings.ca.gov">www.p65warnings.ca.gov</a>	For more information go to <a href="http://www.p65warnings.ca.gov">www.p65warnings.ca.gov</a>

## Contractual warranty

Warranty period	18 months
-----------------	-----------

## Dimensions

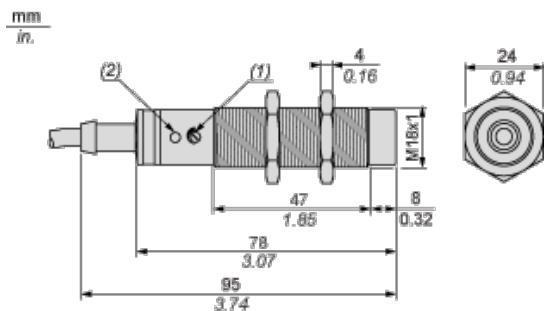

- (1) Adjustment potentiometer
- (2) LED

## Setting-up

### Minimum Mounting Distances (mm)

#### Side by side

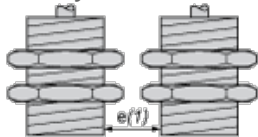

e(1) 40  
≥

#### Face to face

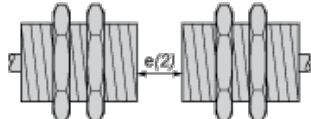

e(2) 48  
≥

#### Facing a metal object

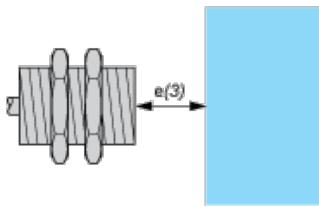

e(3) 24

≥

Mounted in support

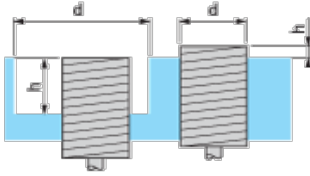

d ≥ 60

h ≥ 20

Fixing nut tightening torque: 3 N.m

## Adjustment

### Sensitivity Adjustment

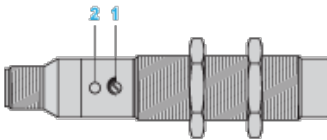

(1) Adjustment potentiometer

(2) LED

## Wiring Diagram

### Pre-cabled

3-wire DC, NPN NO Output

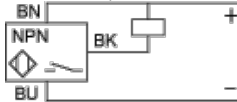

(BU) Blue

(BN) Brown

(BK) Black

## Данный компонент на территории Российской Федерации

### Вы можете приобрести в компании MosChip.

Для оперативного оформления запроса Вам необходимо перейти по данной ссылке:

<http://moschip.ru/get-element>

Вы можете разместить у нас заказ для любого Вашего проекта, будь то серийное производство или разработка единичного прибора.

В нашем ассортименте представлены ведущие мировые производители активных и пассивных электронных компонентов.

Нашей специализацией является поставка электронной компонентной базы двойного назначения, продукции таких производителей как XILINX, Intel (ex.ALTERA), Vicor, Microchip, Texas Instruments, Analog Devices, Mini-Circuits, Amphenol, Glenair.

Сотрудничество с глобальными дистрибьюторами электронных компонентов, предоставляет возможность заказывать и получать с международных складов практически любой перечень компонентов в оптимальные для Вас сроки.

На всех этапах разработки и производства наши партнеры могут получить квалифицированную поддержку опытных инженеров.

Система менеджмента качества компании отвечает требованиям в соответствии с ГОСТ Р ИСО 9001, ГОСТ РВ 0015-002 и ЭС РД 009

### Офис по работе с юридическими лицами:

105318, г.Москва, ул.Щербаковская д.3, офис 1107, 1118, ДЦ «Щербаковский»

Телефон: +7 495 668-12-70 (многоканальный)

Факс: +7 495 668-12-70 (доб.304)

E-mail: [info@moschip.ru](mailto:info@moschip.ru)

Skype отдела продаж:

moschip.ru

moschip.ru\_4

moschip.ru\_6

moschip.ru\_9