

UMSTBVK 2,5/10-G-5,08

Order No.: 1788198

The figure shows a 10-position version of the product

<http://eshop.phoenixcontact.de/phoenix/treeViewClick.do?UID=1788198>

Plug component, Nominal current: 12 A, Rated voltage (III/2): 320 V,
Number of positions: 10, Pitch: 5.08 mm, Connection method: Screw
connection, Color: green, Metal surface: Sn, Assembly: DIN rail

Commercial data	
GTIN (EAN)	 4 017918 043254
sales group	E121
Pack	50 pcs.
Customs tariff	85366990
Catalog page information	Page 293 (CC-2009)

Product notesWEEE/RoHS-compliant since:
01/01/2003

<http://www.download.phoenixcontact.com>
Please note that the data given here has been taken from the online catalog. For comprehensive information and data, please refer to the user documentation. The General Terms and Conditions of Use apply to Internet downloads.

Technical data	
Dimensions / positions	
Width	42.5 mm
Pitch	5.08 mm
Dimension a	45.72 mm
Number of positions	10

Screw thread	M3
Tightening torque, min	0.5 Nm
Tightening torque max	0.6 Nm

Technical data

Range of articles	UMSTBVK 2,5/...-G
Insulating material group	I
Rated surge voltage (III/3)	4 kV
Rated surge voltage (III/2)	4 kV
Rated surge voltage (II/2)	4 kV
Rated voltage (III/2)	320 V
Rated voltage (II/2)	630 V
Connection in acc. with standard	EN-VDE
Nominal current I_N	12 A
Nominal voltage U_N	320 V
Nominal cross section	2.5 mm ²
Insulating material	PA
Inflammability class acc. to UL 94	V2
Internal cylindrical gage	A3
Stripping length	7 mm

Connection data

Conductor cross section solid min.	0.2 mm ²
Conductor cross section solid max.	2.5 mm ²
Conductor cross section stranded min.	0.2 mm ²
Conductor cross section stranded max.	2.5 mm ²
Conductor cross section stranded, with ferrule without plastic sleeve min.	0.25 mm ²
Conductor cross section stranded, with ferrule without plastic sleeve max.	2.5 mm ²
Conductor cross section stranded, with ferrule with plastic sleeve min.	0.25 mm ²
Conductor cross section stranded, with ferrule with plastic sleeve max.	2.5 mm ²
2 conductors with same cross section, solid min.	0.2 mm ²
2 conductors with same cross section, solid max.	1 mm ²
2 conductors with same cross section, stranded min.	0.2 mm ²

2 conductors with same cross section, stranded max.	1.5 mm ²
2 conductors with same cross section, stranded, ferrules without plastic sleeve, min.	0.25 mm ²
2 conductors with same cross section, stranded, ferrules without plastic sleeve, max.	1 mm ²
2 conductors with same cross section, stranded, TWIN ferrules with plastic sleeve, min.	0.5 mm ²
2 conductors with same cross section, stranded, TWIN ferrules with plastic sleeve, max.	1.5 mm ²
Conductor cross section AWG/kcmil min.	24
Conductor cross section AWG/kcmil max	12

Certificates / Approvals

Certification CB, CSA, CUL, GOST, UL, VDE-PZI

Accessories

Item	Designation	Description
Assembly		
1755477	MSTB-BL	Keying cap, for forming sections, plugs onto header pin, green insulating material
General		
1733169	EBP 2- 5	Insertion bridge, fully insulated, for plug connectors with 5.0 or 5.08 mm pitch, no. of positions: 2
Marking		
0804293	SK 5,08/3,8:FORTL.ZAHLEN	Marker card, printed horizontally, self-adhesive, 12 identical decades marked 1-10, 11-20 etc. up to 91-(99)100, sufficient for 120 terminal blocks
Plug/Adapter		
1734401	CR-MSTB	Coding section, inserted into the recess in the header or the inverted plug, red insulating material
Tools		
1205053	SZS 0,6X3,5	Actuation tool, for ST terminal blocks, insulated, also suitable for use as a bladed screwdriver, size: 0.6 x 3.5 x 100 mm, 2-component grip, with non-slip grip

Additional products

Item	Designation	Description
General		
1873139	FKC 2,5/10-ST-5,08	Plug component, Nominal current: 12 A, Rated voltage (III/2): 320 V, Number of positions: 10, Pitch: 5.08 mm, Connection method: Spring-cage conn., Color: green, Metal surface: Sn
1874031	FKCVR 2,5/10-ST-5,08	Plug component, Nominal current: 12 A, Rated voltage (III/2): 320 V, Number of positions: 10, Pitch: 5.08 mm, Connection method: Spring-cage conn., Color: green, Metal surface: Sn
1777361	FRONT-MSTB 2,5/10-ST-5,08	Plug component, Nominal current: 12 A, Rated voltage (III/2): 320 V, Number of positions: 10, Pitch: 5.08 mm, Connection method: Screw connection, Color: green, Metal surface: Sn
1757093	MSTB 2,5/10-ST-5,08	Plug component, Nominal current: 12 A, Rated voltage (III/2): 320 V, Number of positions: 10, Pitch: 5.08 mm, Connection method: Screw connection, Color: green, Metal surface: Sn
1764303	MSTB 2,5/10-STZ-5,08	Plug component, Nominal current: 12 A, Rated voltage (III/2): 320 V, Number of positions: 10, Pitch: 5.08 mm, Connection method: Screw connection, Color: green, Metal surface: Sn
1808890	MSTBC 2,5/10-ST-5,08	Plug component, Nominal current: 12 A, Rated voltage (III/2): 320 V, Number of positions: 10, Pitch: 5.08 mm, Connection method: Crimp connection, Color: green, Metal surface: Sn, Corresponding female crimp contacts with current [A] and conductor cross section range [mm ²] data: 10A/MSTBC-MT 0,5-1,0 (3190564); 10A/MSTBC-MT 0,5-1,0 BA (3190645); 12A/MSTBC-MT 1,5-2,5 (3190551); 12A/MSTBC-MT 1,5-2,5 BA (3190658). BA = Bandkontakte
1809585	MSTBC 2,5/10-STZ-5,08	Plug component, Nominal current: 12 A, Rated voltage (III/2): 320 V, Number of positions: 10, Pitch: 5.08 mm, Connection method: Crimp connection, Color: green, Metal surface: Sn, Corresponding female crimp contacts with current [A] and conductor cross section range [mm ²] data: 10A/MSTBC-MT 0,5-1,0 (3190564); 10A/MSTBC-MT 0,5-1,0 BA (3190645); 12A/MSTBC-MT 1,5-2,5 (3190551); 12A/MSTBC-MT 1,5-2,5 BA (3190658). BA = Bandkontakte
1769094	MSTBP 2,5/10-ST-5,08	Plug component, Nominal current: 12 A, Rated voltage (III/2): 320 V, Number of positions: 10, Pitch: 5.08 mm, Connection method: Screw connection, Color: green, Metal surface: Sn
1792320	MVSTBR 2,5/10-ST-5,08	Plug component, Nominal current: 12 A, Rated voltage (III/2): 320 V, Number of positions: 10, Pitch: 5.08 mm, Connection method: Screw connection, Color: green, Metal surface: Sn
1792838	MVSTBW 2,5/10-ST-5,08	Plug component, Nominal current: 12 A, Rated voltage (III/2): 320 V, Number of positions: 10, Pitch: 5.08 mm, Connection method: Screw connection, Color: green, Metal surface: Sn
1883336	QC 1/10-ST-5,08	Plug component, Nominal current: 10 A, Rated voltage (III/2): 630 V, Number of positions: 10, Pitch: 5.08 mm, Connection method: Insulation displacement connection QUICKON, Color: green, Metal surface: Sn

1826364	SMSTB 2,5/10-ST-5,08	Plug component, Nominal current: 12 A, Rated voltage (III/2): 320 V, Number of positions: 10, Pitch: 5.08 mm, Connection method: Screw connection, Color: green, Metal surface: Sn
---------	----------------------	--

Diagrams/Drawings

Dimensioned drawing

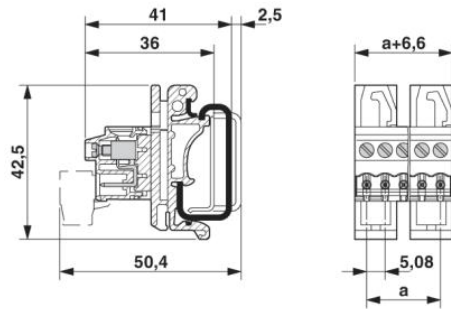

Address

PHOENIX CONTACT Deutschland GmbH
Flachmarktstr. 8
32825 Blomberg, Germany
Phone +49 5235 3 12000
Fax +49 5235 3 41200
<http://www.phoenixcontact.de>



© 2011 Phoenix Contact
Technical modifications reserved;

Данный компонент на территории Российской Федерации

Вы можете приобрести в компании MosChip.

Для оперативного оформления запроса Вам необходимо перейти по данной ссылке:

<http://moschip.ru/get-element>

Вы можете разместить у нас заказ для любого Вашего проекта, будь то серийное производство или разработка единичного прибора.

В нашем ассортименте представлены ведущие мировые производители активных и пассивных электронных компонентов.

Нашей специализацией является поставка электронной компонентной базы двойного назначения, продукции таких производителей как XILINX, Intel (ex.ALTERA), Vicor, Microchip, Texas Instruments, Analog Devices, Mini-Circuits, Amphenol, Glenair.

Сотрудничество с глобальными дистрибьюторами электронных компонентов, предоставляет возможность заказывать и получать с международных складов практически любой перечень компонентов в оптимальные для Вас сроки.

На всех этапах разработки и производства наши партнеры могут получить квалифицированную поддержку опытных инженеров.

Система менеджмента качества компании отвечает требованиям в соответствии с ГОСТ Р ИСО 9001, ГОСТ РВ 0015-002 и ЭС РД 009

Офис по работе с юридическими лицами:

105318, г.Москва, ул.Щербаковская д.3, офис 1107, 1118, ДЦ «Щербаковский»

Телефон: +7 495 668-12-70 (многоканальный)

Факс: +7 495 668-12-70 (доб.304)

E-mail: info@moschip.ru

Skype отдела продаж:

moschip.ru

moschip.ru_4

moschip.ru_6

moschip.ru_9