

-16V Input Three Terminal Negative Voltage Regulator

■ GENERAL DESCRIPTION

The XC6902 Series is a negative voltage CMOS regulator which includes a reference voltage source, error amplifiers, driver transistors, current limiters and phase compensators.

XC6902 is a 3 terminal negative voltage regulator (without CE pin) which is capable of accepting -16V input.

The over current protection circuit will operate when the output current reaches limit current. The thermal shutdown circuit will operate when the junction temperature reaches limit temperature.

■ APPLICATIONS

- Negative power supplies
- Modules (Wireless LAN, Digital still cameras, etc)
- Digital still cameras
- Mobile devices / terminals

■ FEATURES

Maximum Output Current	: 200mA
Input Voltage Range	: -2.4 ~ -16V
Output Voltage Range	: -0.9 ~ -12V
Accuracy	: $\pm 1.5\%$ for -2.0V ~ -12V $\pm 30\text{mV}$ (-0.9V ~ -1.95V)
Temperature Stability	: TYP. $\pm 50\text{ppm}/^\circ\text{C}$
Dropout Voltage	: $400\text{mV}@I_{\text{OUT}}=100\text{mA}$
Low Power Consumption	: $100\ \mu\text{A}$
Protection Circuits	: Current Limit 350mA TYP. Foldback Thermal Shutdown (150°C)
Output Capacitor	: Ceramic Capacitor Compatible
Operating Ambient Temperature	: $-40^\circ\text{C} \sim +85^\circ\text{C}$
Packages	: SOT-23, SOT-89, USP-6C
Environmentally Friendly	: EU RoHS Compliant, Pb Free

■ TYPICAL APPLICATION CIRCUIT

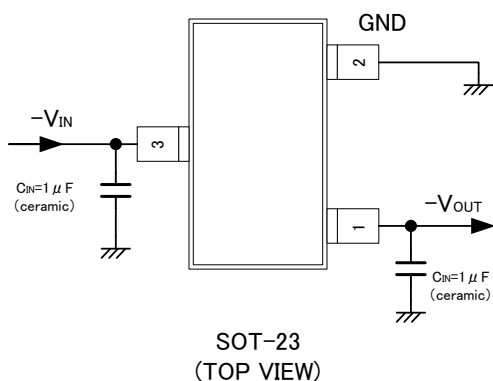

■ TYPICAL PERFORMANCE CHARACTERISTICS

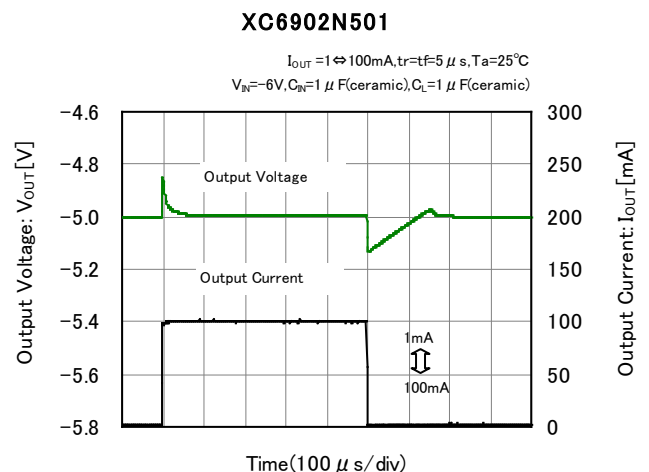

■ BLOCK DIAGRAM

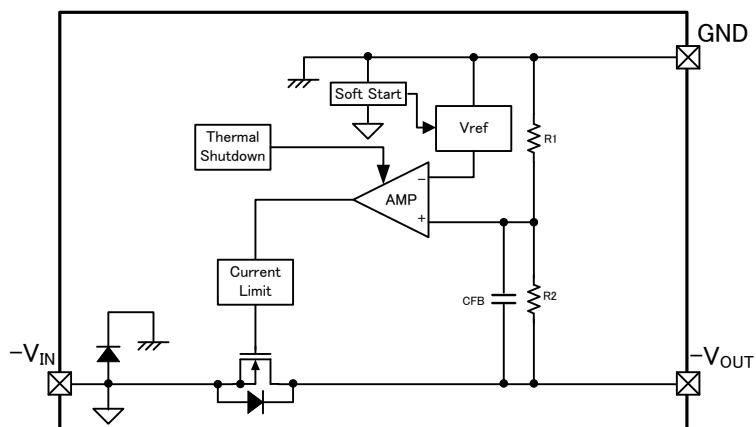

*Diodes inside the circuit are an ESD protection diode and a parasitic diode.

■ PRODUCT CLASSIFICATION

● Ordering Information

XC6902①②③④⑤⑥-⑦^(*) Three Terminal Voltage Regulator

DESIGNATOR	ITEM	SYMBOL	DESCRIPTION
①	Type	N	Soft-start, Thermal Shutdown
②③	Output Voltage	09 ~ C0	e.g.) -2.8V → ②=2, ③=8, -12V → ②=C, ③=0 0.05V increments (-0.9V ~ -4.95V) 0.1V increments (-5.0 ~ -12V)
④	Output Voltage Type	1	0.1V increments e.g.) -1.2V ⇒ ②=1, ③=2, ④=1
		B	0.05V increments e.g.) -1.25V ⇒ ②=1, ③=2, ④=B
⑤⑥-⑦	Packages (Order Unit)	ER-G	USP-6C(3,000pcs/Reel)
		MR-G	SOT-23 (3,000pcs/Reel)
		PR-G	SOT-89(1,000pcs/Reel)

^(*) The "-G" suffix denotes Halogen and Antimony free as well as being fully EU RoHS compliant.

■ PIN CONFIGURATION

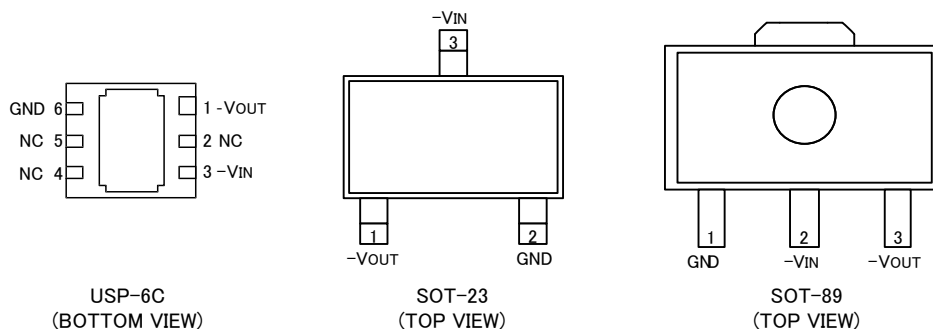

* The dissipation pad for the USP-6C package should be solder-plated in recommended mount pattern and metal masking to enhance mounting strength and heat release. If the pad needs to be connected to other pins, it should be connected to the -V_{IN} (No. 3) pin.

■ PIN ASSIGNMENT

PIN NUMBER			PIN NAME	FUNCTIONS
USP-6C	SOT-23	SOT-89		
3	3	2	-V _{IN}	Negative Supply Input
1	1	3	-V _{OUT}	Negative Output
6	2	1	GND	Ground
2,4,5	-	-	NC	No Connection

■ ABSOLUTE MAXIMUM RATINGS

GND=0V, Ta=25°C

PARAMETER		SYMBOL	RATINGS	UNITS
Input Voltage		V _{IN}	GND-18 ~ GND+0.3	V
Output Current ⁽¹⁾		I _{OUT}	500	mA
Output Voltage		V _{OUT}	V _{IN} -0.3 ~ V _{IN} +18	V
Power Dissipation	USP-6C	Pd	120	mW
			1000(40mm x 40mm Standard board) ⁽²⁾	
			1250(JESD51-7 board) ⁽²⁾	
	SOT-23		250	
			500(40mm x 40mm Standard board) ⁽²⁾	
			SOT-89	
1000(40mm x 40mm Standard board) ⁽²⁾				
Operating Ambient Temperature		Topr	-40 ~ +85	°C
Storage Temperature		Tstg	-55 ~ +125	°C

⁽¹⁾ Please use within the range of $I_{OUT} \leq Pd / (V_{OUT} - V_{IN})$

⁽²⁾ The power dissipation figure shown is PCB mounted and is for reference only.
Please refer to PACKAGING INFORMATION for the mounting condition.

ELECTRICAL CHARACTERISTICS

●XC6902 Series

GND=0V, Ta=2

PARAMETER	SYMBOL	CONDITIONS		MIN.	TYP.	MAX.	UNITS	CIRCUIT
Output Voltage	V _{OUT(E)} ^{(*)2}	I _{OUT} =20mA	V _{OUT(T)} <-2.0V	×1.015	V _{OUT(T)} ^{(*)1}	×0.985	V	①
			V _{OUT(T)} ≥-2.0V	-0.030		+0.030		
Maximum Output Current ^{(*)4}	I _{OUTMAX}	V _{IN} =V _{OUT(T)} -2.0V	V _{OUT(T)} ≤-2.4V	200	-	-	mA	①
		V _{IN} =-4.4V	V _{OUT(T)} >-2.4V					
Load Regulation	ΔV _{OUT}	V _{IN} =V _{OUT(T)} -1.0V	V _{OUT(T)} ≤-3.0V	-	20	60	mV	①
		V _{IN} =-4.0V	V _{OUT(T)} >-3.0V					
		1mA≤I _{OUT} ≤100mA						
Dropout Voltage	V _{dif} ^{(*)3}	I _{OUT} =20mA		-	E-1 ^{(*)5}		mV	①
Supply Current	I _{BIAS}	V _{IN} =-16V, I _{OUT} =0mA		-	100	200	μA	①
Input Line Regulation	ΔV _{OUT} / (ΔV _{IN} · V _{OUT})	V _{IN} : -16V~-2.4V	V _{OUT(T)} >-1.4V	-	0.05	0.20	%V	①
		V _{IN} : -16V~V _{OUT(T)} -1V	-9≤V _{OUT(T)} ≤-1.4V					
		V _{IN} : -16V~V _{OUT(T)} -1V	V _{OUT(T)} <-9.0V	-	0.1	0.30		
		I _{OUT} =20mA						
Input Voltage	V _{IN}			-16	-	-2.4	V	①
Output Voltage Temperature Characteristics	ΔV _{OUT} / (ΔT _{opr} · V _{OUT})	I _{OUT} =20mA -40°C≤T _{opr} ≤85°C		-	±50	-	ppm/°C	①
Ripple Rejection Ratio	PSRR	V _{IN} ={V _{OUT(T)} -1.0}+0.5Vp-pAC, I _{OUT} =20mA, f=1kHz		-	45	-	dB	②
Limit Current	I _{LIM}	V _{IN} =V _{OUT(T)} -2.0V	V _{OUT(T)} ≤-2.4V	210	300	-	mA	①
		V _{IN} =-4.4V	V _{OUT(T)} >-2.4V					
Short-Circuit Current	I _{SHORT}	V _{IN} =V _{OUT(T)} -2.0V Short -V _{OUT} to GND level		-	80	-	mA	①
Detect Thermal Shutdown Temperature	T _{TSD}	IC Junction temperature		-	150	-	°C	①
Release Thermal Shutdown Temperature	T _{TSR}	IC Junction temperature		-	125	-	°C	①
Hysteresis Width	T _{HYS}	T _{TSD} -T _{TSR}		-	25	-	°C	①
Soft Start Time	t _{SS}	R _L =3kΩ ^{(*)6}	V _{OUT(T)} >-4.0V	0.12	0.4	1.2	ms	③
			V _{OUT(T)} ≤-4.0V	0.2	0.7	2	ms	③

NOTE:

The test condition for input voltage, Unless otherwise stated, GND=0V, V_{IN}=V_{OUT(T)}-1.0V or -2.4V.

(*)1 V_{OUT(T)}: Nominal output voltage

(*)2 V_{OUT(E)}: Effective output voltage (see the voltage chart)

(ie. The output voltage when "V_{OUT(T)}-1.0V" or "-2.4V" is provided at the V_{IN} pin while maintaining a certain I_{OUT} value.

(*)3 V_{dif} = -{V_{IN1} - V_{OUT1}}

V_{IN1} is the input voltage when V_{OUT1} appears at the V_{OUT} pin while input voltage is gradually increased

V_{OUT1} is the voltage equal to 98% of the normal output voltage when amply stabilized V_{OUT(T)} -1.0V or -2.4V (the bigger absolute value one) are input at the V_{IN} pin.

(*)4 The maximum current may not be able to flow when thermal shutdown operates, it depends on power dissipation.

(*)5 E-1: Refer to Dropout Voltage Chart.

(*)6 Input voltage condition is V_{IN}=0V → V_{OUT}-1V with 5μs rising time.

Soft-start time t_{SS} is defined as the time taken from the 90% rising of V_{IN} to the 95% rising of V_{OUT(E)}.

■ ELECTRICAL CHARACTERISTICS(Continued)

● Dropout Voltage Chart 1

NOMINAL OUTPUT VOLTAGE	E-1		NOMINAL OUTPUT VOLTAGE	E-1		NOMINAL OUTPUT VOLTAGE	E-1	
	DROPOUT VOLTAGE Vdif (mV)			DROPOUT VOLTAGE Vdif (mV)			DROPOUT VOLTAGE Vdif (mV)	
V _{OUT(T)}	TYP.	MAX.	V _{OUT(T)}	TYP.	MAX.	V _{OUT(T)}	TYP.	MAX.
-0.90	800	1500	-2.85	116	157	-4.8	80	115
-0.95	750	1450	-2.9	114	155	-4.85	80	115
-1.00	700	1400	-2.95	112	153	-4.9	79	115
-1.05	650	1350	-3.00	110	151	-4.95	79	115
-1.10	600	1300	-3.05	109	150	-5.00	78	114
-1.15	550	1250	-3.1	108	148			
-1.20	500	1200	-3.15	107	147			
-1.25	450	1150	-3.2	105	145			
-1.30	400	1100	-3.25	104	144			
-1.35	350	1050	-3.3	102	142			
-1.40	300	1000	-3.35	102	141			
-1.45	270	950	-3.4	101	140			
-1.50	230	900	-3.45	101	139			
-1.55	220	850	-3.5	100	137			
-1.60	210	800	-3.55	99	136			
-1.65	205	750	-3.6	98	135			
-1.70	200	700	-3.65	97	134			
-1.75	195	650	-3.70	95	133			
-1.80	190	600	-3.75	95	132			
-1.85	183	550	-3.8	94	131			
-1.90	176	500	-3.85	94	130			
-1.95	171	450	-3.9	93	129			
-2.00	165	400	-3.95	92	128			
-2.05	161	350	-4.00	91	127			
-2.10	156	300	-4.05	90	126			
-2.15	152	250	-4.10	89	125			
-2.20	148	200	-4.15	89	125			
-2.25	144	187	-4.20	88	124			
-2.30	140	185	-4.25	87	123			
-2.35	138	183	-4.30	86	122			
-2.40	135	181	-4.35	86	122			
-2.45	132	178	-4.40	85	121			
-2.50	129	174	-4.45	85	120			
-2.55	127	172	-4.50	84	119			
-2.60	125	169	-4.55	83	119			
-2.65	123	166	-4.60	82	119			
-2.70	121	163	-4.65	82	118			
-2.75	119	161	-4.70	82	117			
-2.80	117	159	-4.75	81	116			

ELECTRICAL CHARACTERISTICS(Continued)

● Dropout Voltage Chart 2

NOMINAL OUTPUT VOLTAGE	E-1		NOMINAL OUTPUT VOLTAGE	E-1	
	DROPOUT VOLTAGE Vdif (mV)			DROPOUT VOLTAGE Vdif (mV)	
V _{OUT(T)}	TYP.	MAX.	V _{OUT(T)}	TYP.	MAX.
-5.1	77	113	-9	58	93
-5.2	77	112	-9.1	58	92
-5.3	76	111	-9.2	58	92
-5.4	75	110	-9.3	57	92
-5.5	74	110	-9.4	57	91
-5.6	73	109	-9.5	56	91
-5.7	73	108	-9.6	56	91
-5.8	72	107	-9.7	56	91
-5.9	71	106	-9.8	55	90
-6	70	105	-9.9	55	90
-6.1	70	105	-10	54	90
-6.2	69	104	-10.1	54	90
-6.3	69	104	-10.2	54	89
-6.4	68	103	-10.3	54	89
-6.5	67	102	-10.4	54	89
-6.6	66	102	-10.5	53	88
-6.7	66	101	-10.6	53	88
-6.8	65	101	-10.7	53	88
-6.9	65	100	-10.8	53	88
-7	65	100	-10.9	53	88
-7.1	64	99	-11	52	88
-7.2	64	99	-11.1	53	88
-7.3	63	98	-11.2	52	87
-7.4	63	98	-11.3	51	87
-7.5	62	98	-11.4	51	87
-7.6	62	98	-11.5	50	87
-7.7	62	97	-11.6	50	87
-7.8	61	96	-11.7	50	87
-7.9	61	96	-11.8	50	87
-8	60	96	-11.9	50	87
-8.1	60	96	-12	50	87
-8.2	60	95			
-8.3	60	95			
-8.4	60	94			
-8.5	59	94			
-8.6	59	94			
-8.7	59	94			
-8.8	59	93			
-8.9	59	93			

■ TEST CIRCUIT

1) CIRCUIT①

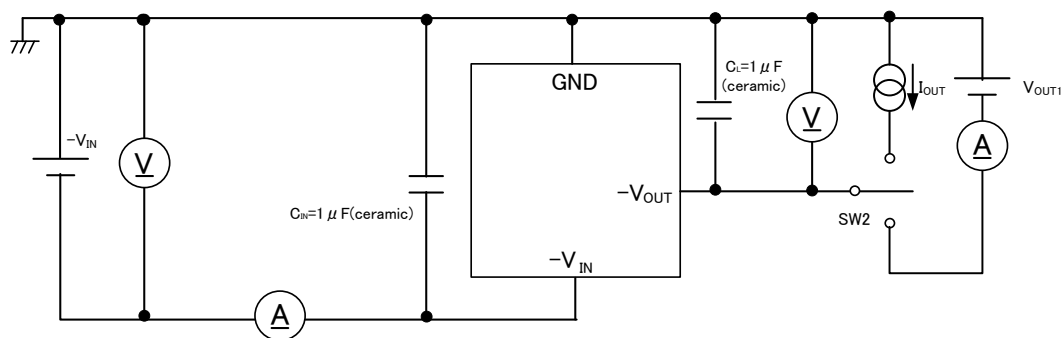

2) CIRCUIT②

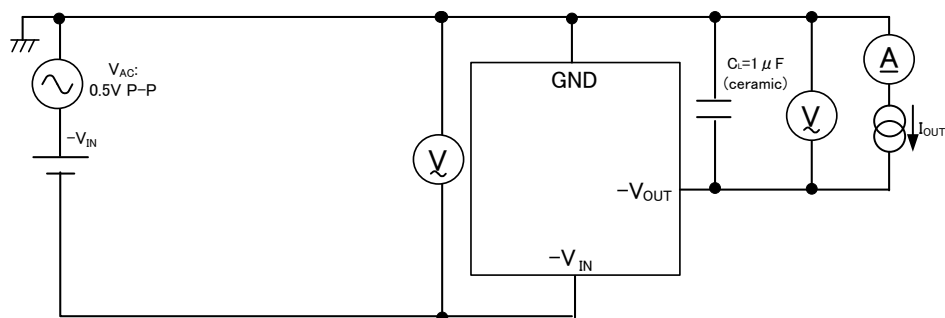

3) CIRCUIT③

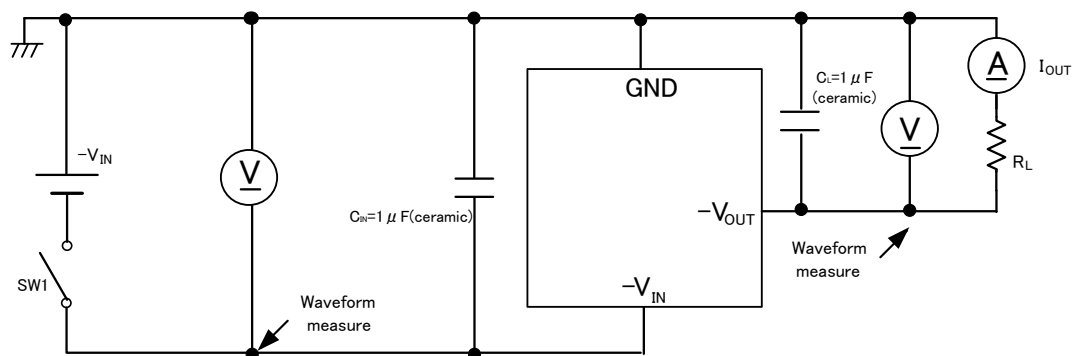

OPERATIONAL EXPLANATION

The voltage divided by resistors R1 and R2 is compared with the internal reference voltage based on ground by the error amplifier. The driver transistor tied to the $-V_{IN}$ pin is then driven by the subsequent output signal. The output voltage at the $-V_{OUT}$ pin is controlled and stabilized by a system of negative feedback.

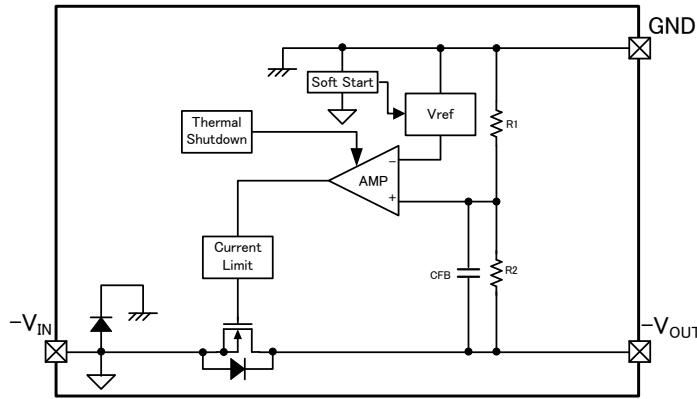

XC6902 Series

< Soft-Start Function >

The XC6902 series includes soft-start circuit. During power start-up, the inrush current from $-V_{IN}$ pin to V_{OUT} pin to charge C_L capacitor can be reduced and it makes the V_{IN} stable. Soft-start time (t_{SS}) is optimized internally.

Figure1 : Soft-Start Time and Inrush Current

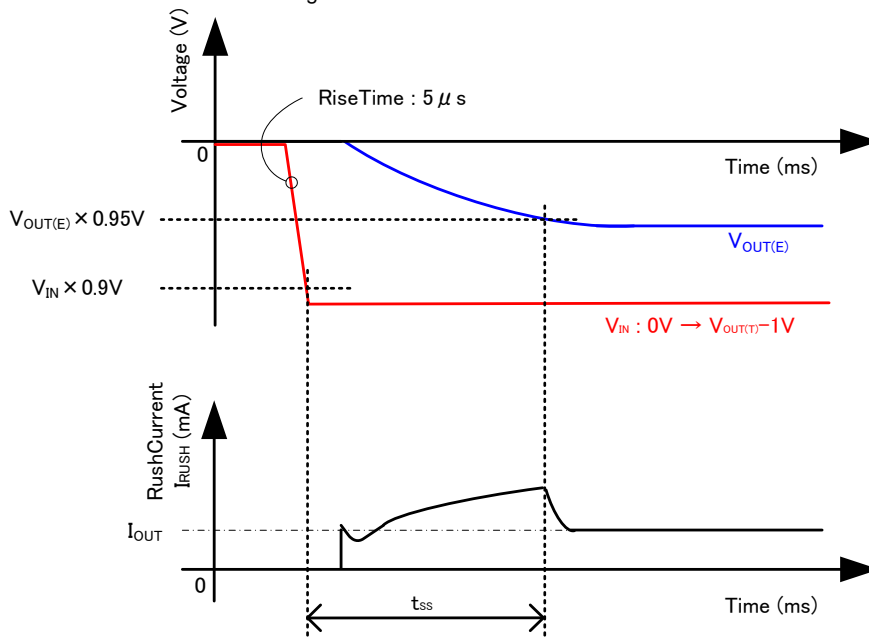

< Current Limiter, Short-Circuit Protection >

The XC6902 series fold-back circuit operates as an output current limiter and a short protection circuit for the output pin. When the output current reaches the current limit level, output voltage drops with the decrease of the output current. There are no parasitic diode between the $-V_{OUT}$ pin and GND pin. The minimized short-circuit current is maintained even if the $-V_{OUT}$ pin voltage is pulled up toward positive.

< Thermal Shutdown >

The XC6902 Series has an internal thermal shutdown (TSD) circuit for protection against overheating. When the junction temperature reaches the detection temperature, the driver transistor is forcibly turned off. When the junction temperature falls to the release temperature with the driver transistor still in the off state, the driver transistor turns on (automatic recovery) and restarts regulator operation.

■ OPERATIONAL EXPLANATION (Continued)

<Low ESR Capacitor>

With the XC6902 series, a stable output voltage is achievable even if used with low ESR capacitors, as a phase compensation circuit is built-in. The output capacitor (C_L) should be connected as close to V_{OUT} pin and GND pin to obtain stable phase compensation. Values required for the phase compensation are as the table below.

For a stable power input, please connect an input capacitor (C_{IN}) near power supply. In order to ensure the stable phase compensation while avoiding run-out of values, please use the capacitor (C_{IN} , C_L) which does not depend on bias or temperature too much. The table below shows recommended values of C_{IN} , C_L .

CHART 1 : Recommended Values of C_{IN} , C_L

OUTPUT VOLTAGE RANGE	INPUT CAPACITOR	OUTPUT CAPACITOR
$V_{OUT(T)}$	C_{IN}	C_L
-0.9V~-12V	1.0 μ F~	1.0 μ F~100 μ F

■ NOTES ON USE

1. Please use this IC within the stated maximum ratings. For temporary, transitional voltage drop or voltage rising phenomenon, the IC is liable to malfunction should the ratings be exceeded.
2. Where wiring impedance is high, operations may become unstable due to noise and/or phase lag depending on output current. Please keep the resistance low for the $-V_{IN}$ and GND wiring in particular.
3. Please wire the C_{IN} and C_L as close to the IC as possible.
4. Capacitances of these capacitors (C_{IN} , C_L) are decreased by the influences of bias voltage and ambient temperature. Care shall be taken for capacitor selection to ensure stability of phase compensation from the point of ESR influence.
5. Torex places an importance on improving our products and its reliability.
However, by any possibility, we would request user fail-safe design and post-aging treatment on system or equipment.

TYPICAL PERFORMANCE CHARACTERISTICS

(1) Output Voltage vs. Output Current

XC6902N331

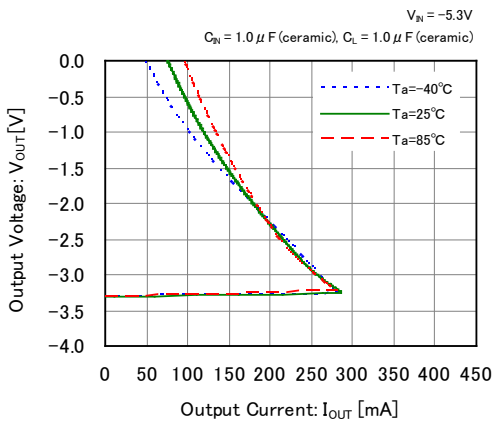

XC6902N331

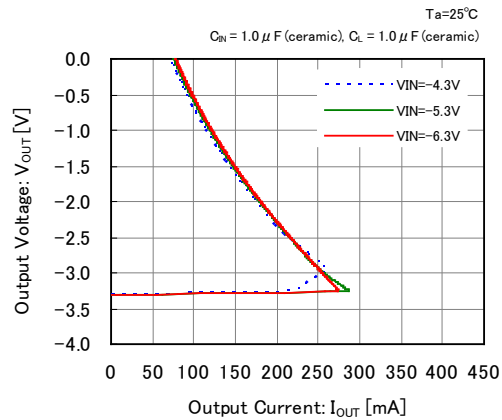

XC6902N501

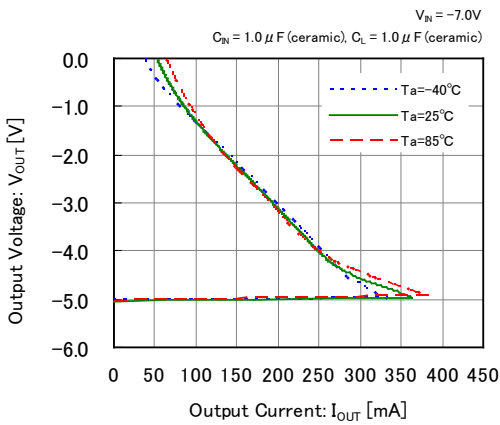

XC6902N501

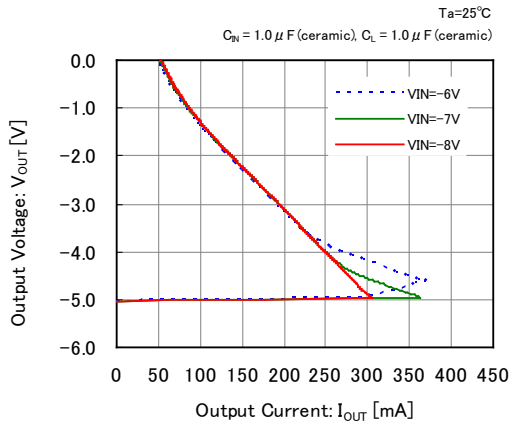

XC6902NC01

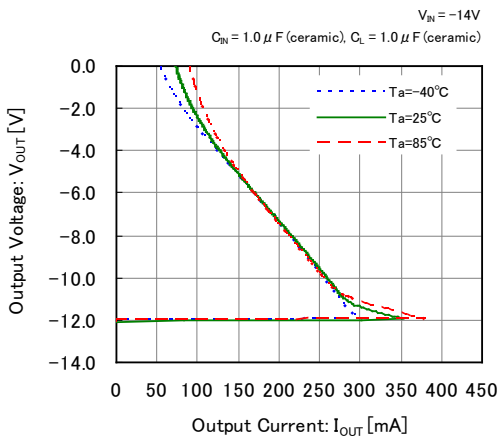

XC6902NC01

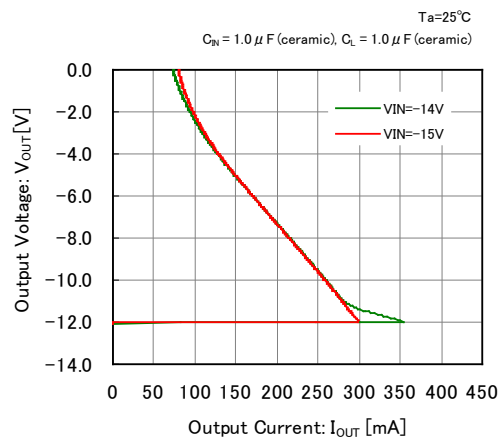

■ TYPICAL PERFORMANCE CHARACTERISTICS (Continued)

(2) Output Voltage vs. Input Voltage

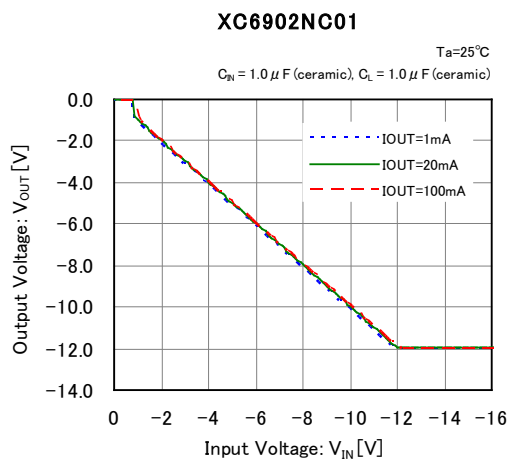
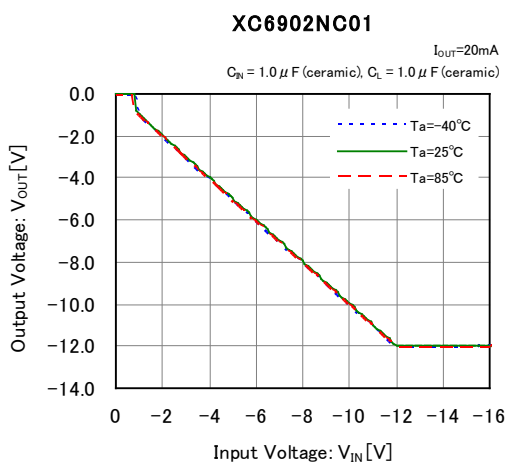
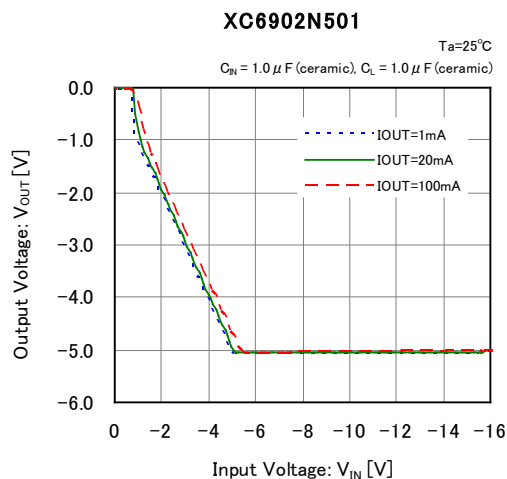
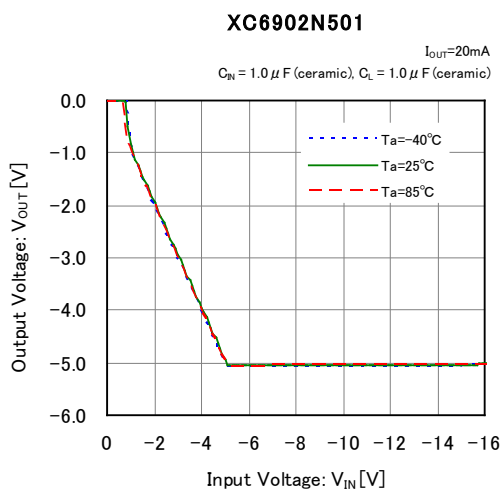
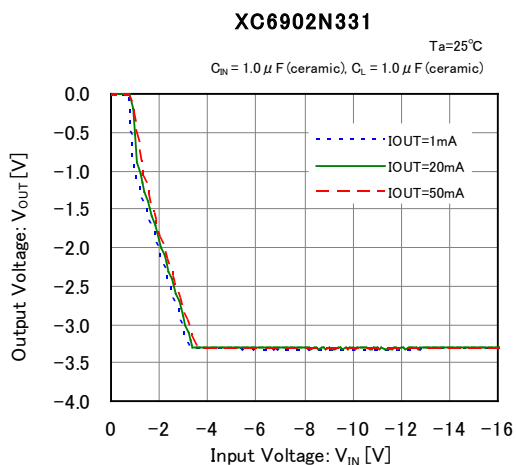
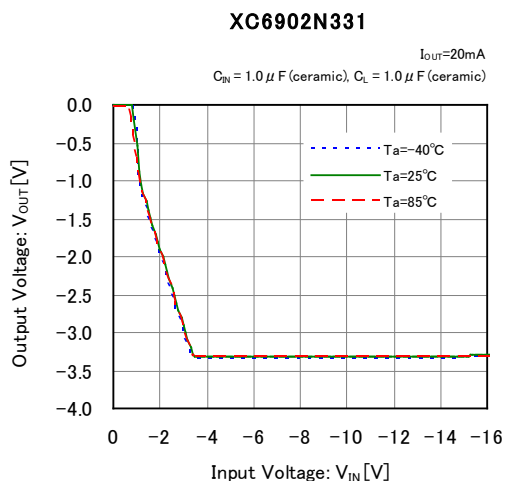

TYPICAL PERFORMANCE CHARACTERISTICS (Continued)

(3) Dropout Voltage vs. Output Current

XC6902N331

$C_{IN} = 1.0 \mu F$ (ceramic), $C_L = 1.0 \mu F$ (ceramic)

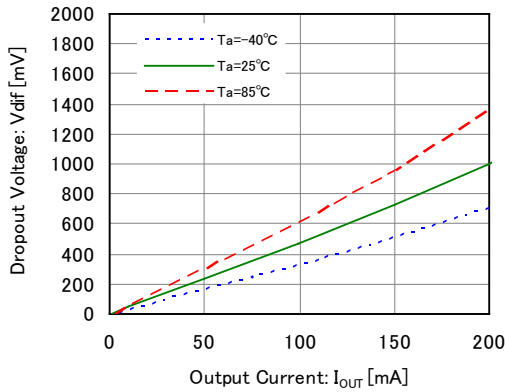

XC6902N501

$C_{IN} = 1.0 \mu F$ (ceramic), $C_L = 1.0 \mu F$ (ceramic)

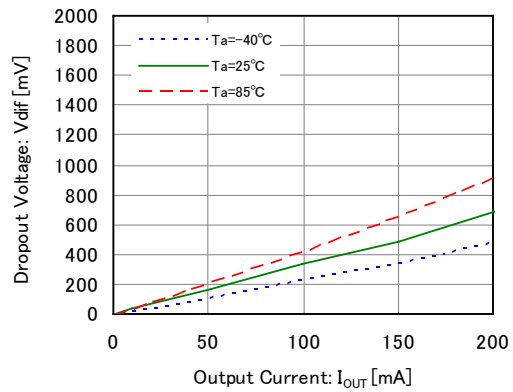

XC6902NC01

$C_{IN} = 1.0 \mu F$ (ceramic), $C_L = 1.0 \mu F$ (ceramic)

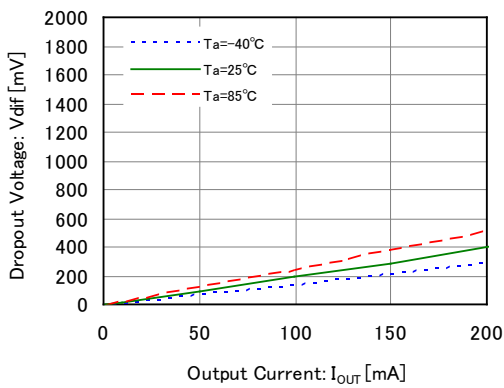

XC6902N331

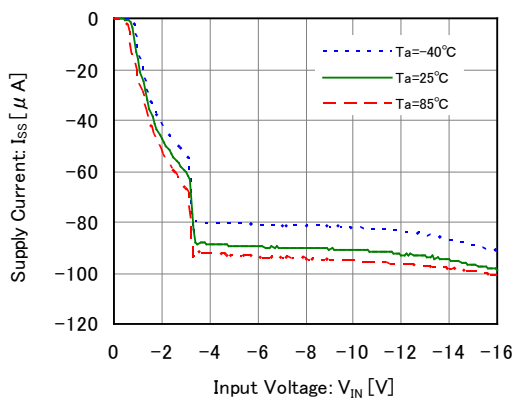

XC6902N501

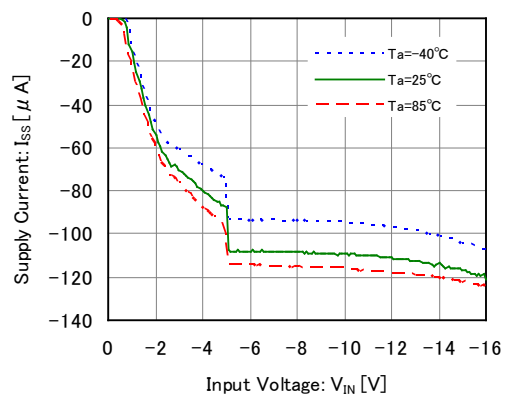

■ TYPICAL PERFORMANCE CHARACTERISTICS (Continued)

(4) Supply Current vs. Input Voltage

XC6902NC01

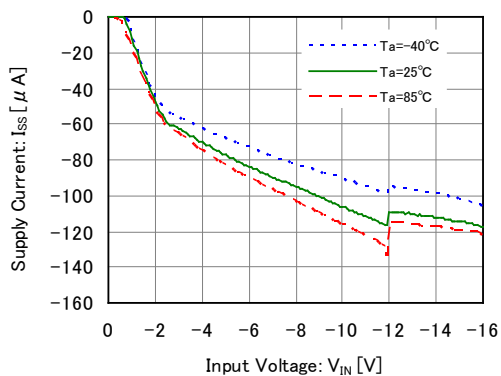

(5) Output Voltage vs. Ambient Temperature

XC6902N331

$V_{IN} = -4.3\text{V}, I_{OUT} = 20\text{mA}$
 $C_B = 1 \mu\text{F}(\text{ceramic}), C_L = 1 \mu\text{F}(\text{ceramic})$

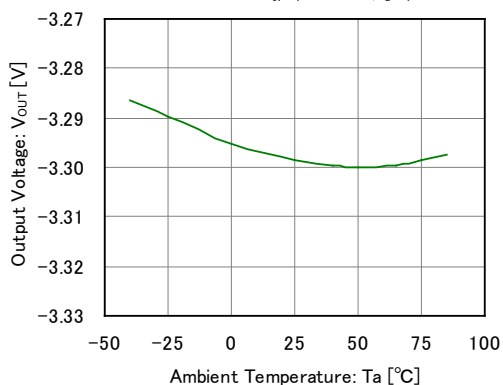

XC6902N501

$V_{IN} = -6.0\text{V}, I_{OUT} = 20\text{mA}$
 $C_B = 1 \mu\text{F}(\text{ceramic}), C_L = 1 \mu\text{F}(\text{ceramic})$

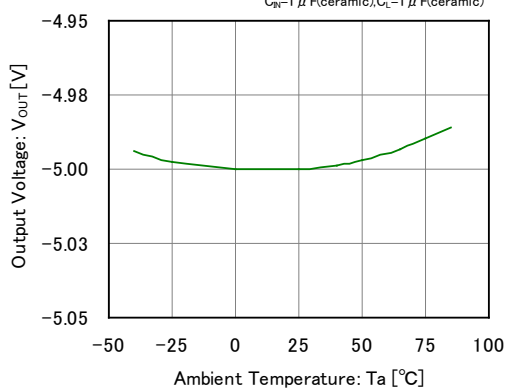

XC6902NC01

$V_{IN} = -13\text{V}, I_{OUT} = 20\text{mA}$
 $C_B = 1 \mu\text{F}(\text{ceramic}), C_L = 1 \mu\text{F}(\text{ceramic})$

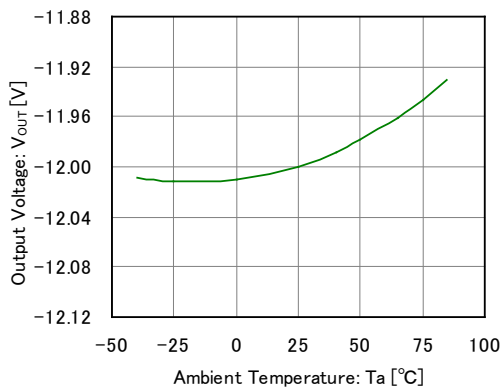

TYPICAL PERFORMANCE CHARACTERISTICS (Continued)

(6) Input Rising Response Time

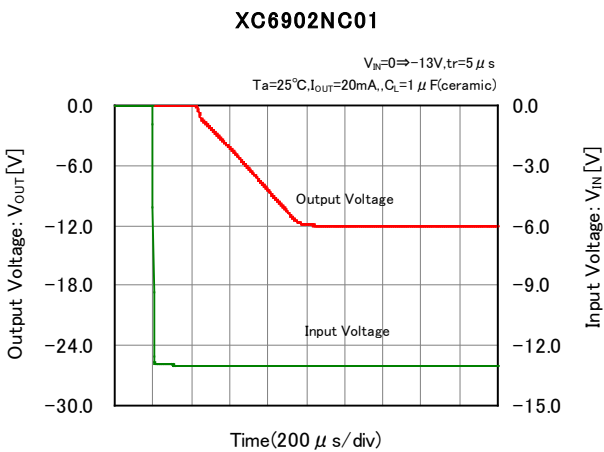
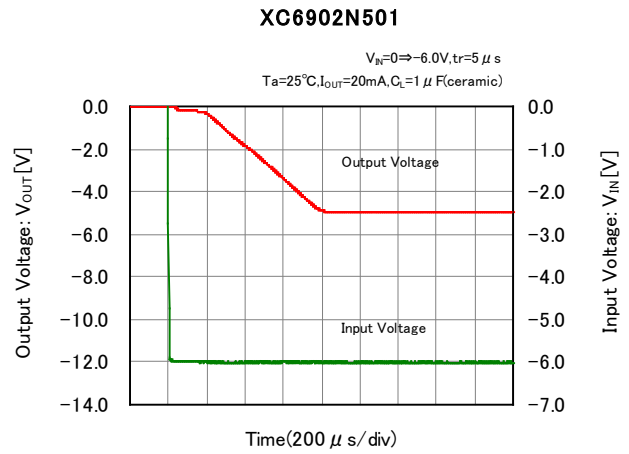
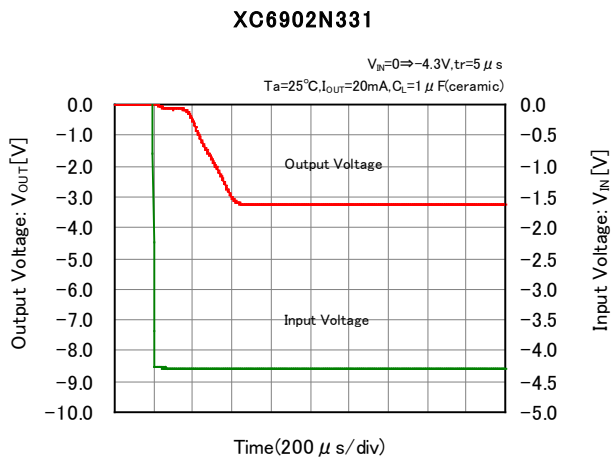

(7) Input Transient Response

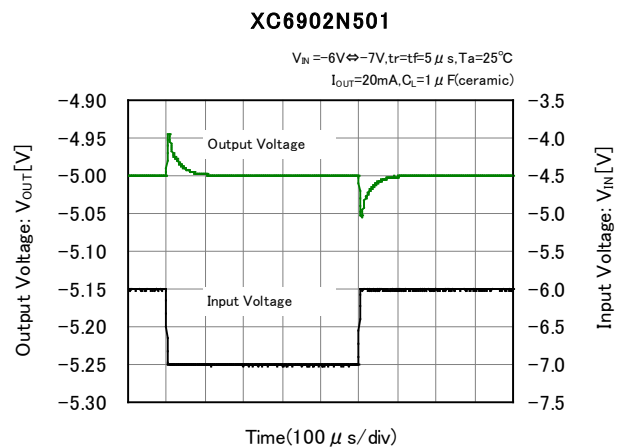
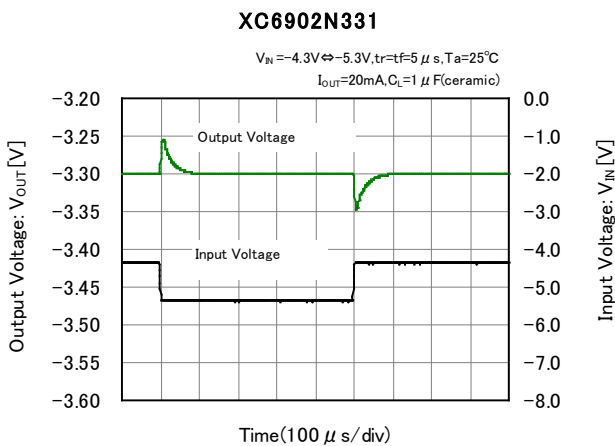

■ TYPICAL PERFORMANCE CHARACTERISTICS (Continued)

(7) Input Transient Response (Continued)

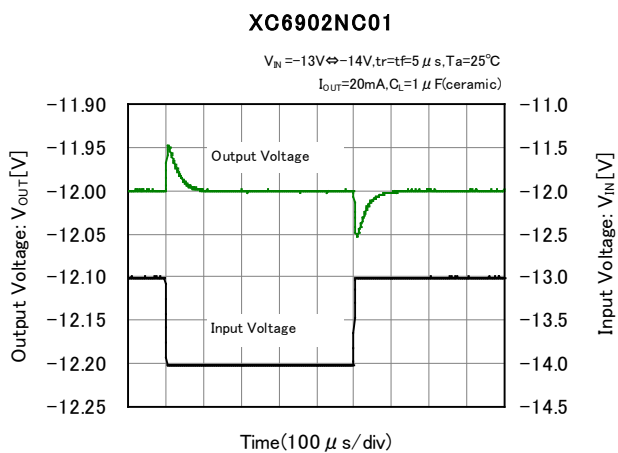

(8) Load Transient Response

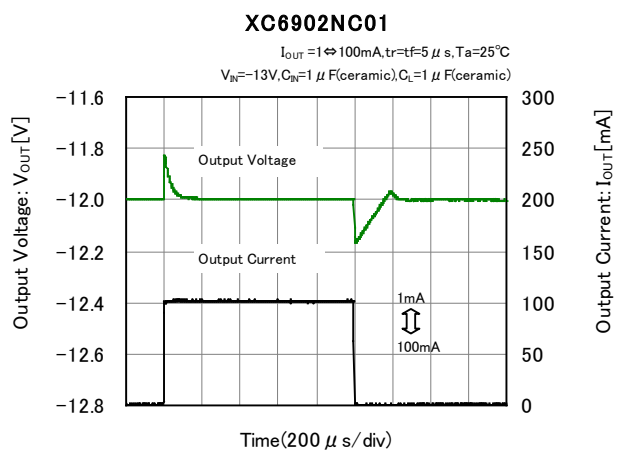
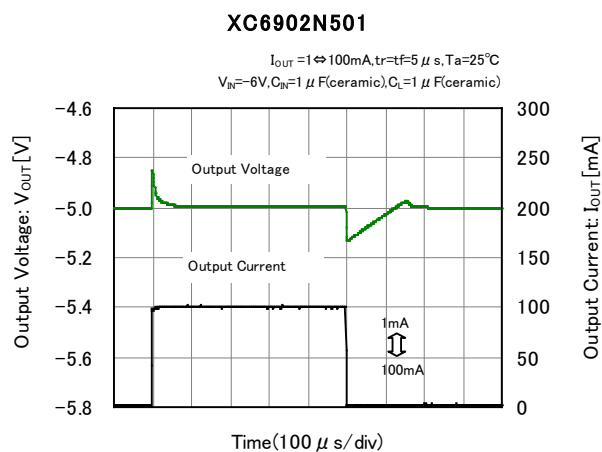
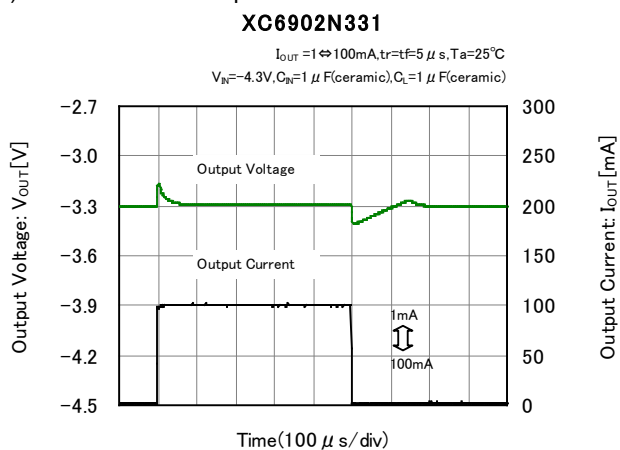

TYPICAL PERFORMANCE CHARACTERISTICS (Continued)

(9) Ripple Rejection Rate

XC6902N331

$T_a=25^\circ\text{C}$, $V_{IN}=-4.3\text{V}+0.5V_{P-PAC}$
 $C_L=1\ \mu\text{F}(\text{ceramic})$

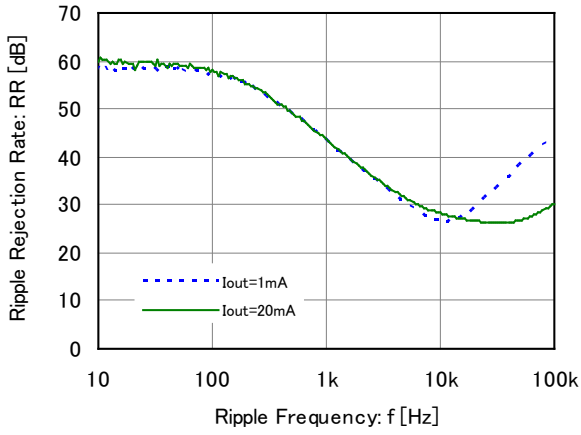

XC6902N501

$T_a=25^\circ\text{C}$, $V_{IN}=-6\text{V}+0.5V_{P-PAC}$
 $C_L=1\ \mu\text{F}(\text{ceramic})$

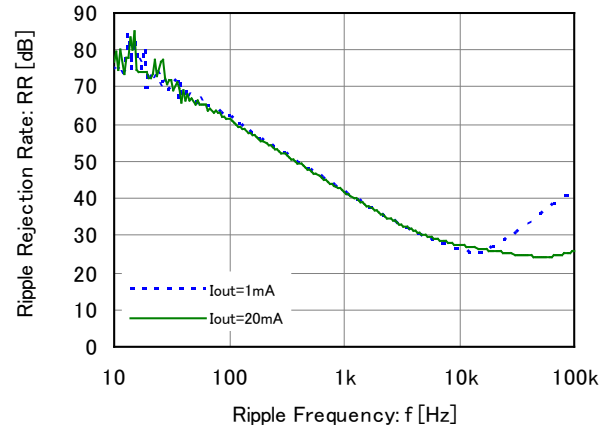

XC6902NC01

$T_a=25^\circ\text{C}$, $V_{IN}=-13\text{V}+0.5V_{P-PAC}$
 $C_L=1\ \mu\text{F}(\text{ceramic})$

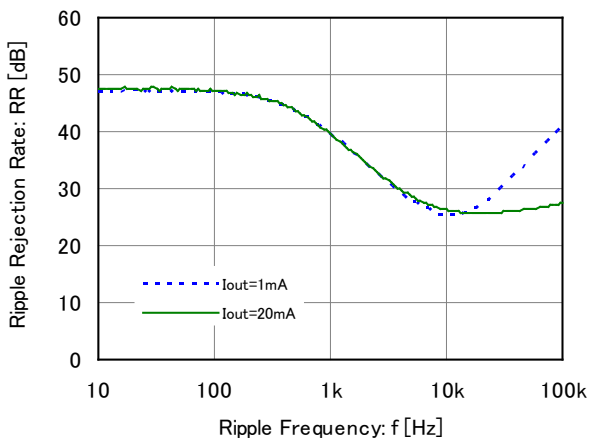

■ PACKAGING INFORMATION

For the latest package information go to, www.torexsemi.com/technical-support/packages

PACKAGE	OUTLINE / LAND PATTERN	THERMAL CHARACTERISTICS	
SOT-23	SOT-23 PKG	Standard Board	SOT-23 Power Dissipation
SOT-89	SOT-89 PKG	Standard Board	SOT-89 Power Dissipation
USP-6C	USP-6C PKG	Standard Board	USP-6C Power Dissipation
		JESD51-7 Board	

MARKING RULE

● SOT-23, SOT-89

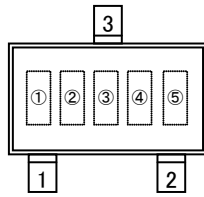

SOT-23

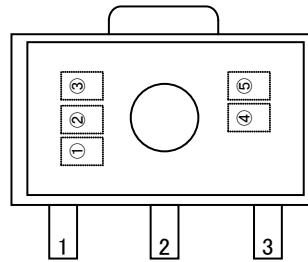

SOT-89

① represents product series

MARK	PRODUCT SERIES
E	XC6902xxxxxx-G

② represents output voltage range

MARK	VOLTAGE (V)	PRODUCT SERIES
A	-0.9 ~ -3.8	XC6902*091**-G ~ XC6902*381**-G
B	-3.9 ~ -6.8	XC6902*391**-G ~ XC6902*681**-G
C	-6.9 ~ -9.8	XC6902*691**-G ~ XC6902*981**-G
D	-9.9 ~ -12.0	XC6902*991**-G ~ XC6902*C01**-G
E	-0.95 ~ -3.85	XC6902*09B**-G ~ XC6902*38B**-G
F	-3.95 ~ -4.95	XC6902*39B**-G ~ XC6902*49B**-G

③ represents output voltage

MARK	OUTPUT VOLTAGE(V)						MARK	OUTPUT VOLTAGE(V)					
0	-0.9	-3.9	-6.9	-9.9	-0.95	-3.95	N	-2.9	-5.9	-8.9	-11.9	-2.95	
1	-1.0	-4.0	-7.0	-10.0	-1.05	-4.05	P	-3.0	-6.0	-9.0	-12.0	-3.05	
2	-1.1	-4.1	-7.1	-10.1	-1.15	-4.15	R	-3.1	-6.1	-9.1	-	-3.15	
3	-1.2	-4.2	-7.2	-10.2	-1.25	-4.25	S	-3.2	-6.2	-9.2	-	-3.25	
4	-1.3	-4.3	-7.3	-10.3	-1.35	-4.35	T	-3.3	-6.3	-9.3	-	-3.35	
5	-1.4	-4.4	-7.4	-10.4	-1.45	-4.45	U	-3.4	-6.4	-9.4	-	-3.45	
6	-1.5	-4.5	-7.5	-10.5	-1.55	-4.55	V	-3.5	-6.5	-9.5	-	-3.55	
7	-1.6	-4.6	-7.6	-10.6	-1.65	-4.65	X	-3.6	-6.6	-9.6	-	-3.65	
8	-1.7	-4.7	-7.7	-10.7	-1.75	-4.75	Y	-3.7	-6.7	-9.7	-	-3.75	
9	-1.8	-4.8	-7.8	-10.8	-1.85	-4.85	Z	-3.8	-6.8	-9.8	-	-3.85	
A	-1.9	-4.9	-7.9	-10.9	-1.95	-4.95							
B	-2.0	-5.0	-8.0	-11.0	-2.05	-							
C	-2.1	-5.1	-8.1	-11.1	-2.15	-							
D	-2.2	-5.2	-8.2	-11.2	-2.25	-							
E	-2.3	-5.3	-8.3	-11.3	-2.35	-							
F	-2.4	-5.4	-8.4	-11.4	-2.45	-							
H	-2.5	-5.5	-8.5	-11.5	-2.55	-							
K	-2.6	-5.6	-8.6	-11.6	-2.65	-							
L	-2.7	-5.7	-8.7	-11.7	-2.75	-							
M	-2.8	-5.8	-8.8	-11.8	-2.85	-							

④⑤ represents production lot number

01~09, 0A~0Z, 11~9Z, A1~A9, AA~AZ, B1~ZZ repeated.

(G, I, J, O, Q, W excluded.)

* No character inversion used.

MARKING RULE

● USP-6C

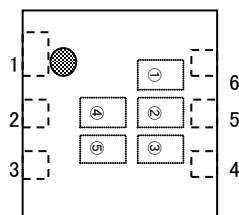

USP-6C

① represents product series

MARK	PRODUCT SERIES
T	XC6902xxxxxx-G

② represents output voltage range

MARK	VOLTAGE (V)	PRODUCT SERIES
A	-0.9 ~ -3.8	XC6902*091**-G ~ XC6902*381**-G
B	-3.9 ~ -6.8	XC6902*391**-G ~ XC6902*681**-G
C	-6.9 ~ -9.8	XC6902*691**-G ~ XC6902*981**-G
D	-9.9 ~ -12.0	XC6902*991**-G ~ XC6902*C01**-G
E	-0.95 ~ -3.85	XC6902*09B**-G ~ XC6902*38B**-G
F	-3.95 ~ -4.95	XC6902*39B**-G ~ XC6902*49B**-G

③ represents output voltage

MARK	OUTPUT VOLTAGE(V)						MARK	OUTPUT VOLTAGE(V)					
0	-0.9	-3.9	-6.9	-9.9	-0.95	-3.95	N	-2.9	-5.9	-8.9	-11.9	-2.95	
1	-1.0	-4.0	-7.0	-10.0	-1.05	-4.05	P	-3.0	-6.0	-9.0	-12.0	-3.05	
2	-1.1	-4.1	-7.1	-10.1	-1.15	-4.15	R	-3.1	-6.1	-9.1	-	-3.15	
3	-1.2	-4.2	-7.2	-10.2	-1.25	-4.25	S	-3.2	-6.2	-9.2	-	-3.25	
4	-1.3	-4.3	-7.3	-10.3	-1.35	-4.35	T	-3.3	-6.3	-9.3	-	-3.35	
5	-1.4	-4.4	-7.4	-10.4	-1.45	-4.45	U	-3.4	-6.4	-9.4	-	-3.45	
6	-1.5	-4.5	-7.5	-10.5	-1.55	-4.55	V	-3.5	-6.5	-9.5	-	-3.55	
7	-1.6	-4.6	-7.6	-10.6	-1.65	-4.65	X	-3.6	-6.6	-9.6	-	-3.65	
8	-1.7	-4.7	-7.7	-10.7	-1.75	-4.75	Y	-3.7	-6.7	-9.7	-	-3.75	
9	-1.8	-4.8	-7.8	-10.8	-1.85	-4.85	Z	-3.8	-6.8	-9.8	-	-3.85	
A	-1.9	-4.9	-7.9	-10.9	-1.95	-4.95							
B	-2.0	-5.0	-8.0	-11.0	-2.05	-							
C	-2.1	-5.1	-8.1	-11.1	-2.15	-							
D	-2.2	-5.2	-8.2	-11.2	-2.25	-							
E	-2.3	-5.3	-8.3	-11.3	-2.35	-							
F	-2.4	-5.4	-8.4	-11.4	-2.45	-							
H	-2.5	-5.5	-8.5	-11.5	-2.55	-							
K	-2.6	-5.6	-8.6	-11.6	-2.65	-							
L	-2.7	-5.7	-8.7	-11.7	-2.75	-							
M	-2.8	-5.8	-8.8	-11.8	-2.85	-							

④⑤ represents production lot number

01~09, 0A~0Z, 11~9Z, A1~A9, AA~AZ, B1~ZZ repeated.

(G, I, J, O, Q, W excluded.)

* No character inversion used.

1. The product and product specifications contained herein are subject to change without notice to improve performance characteristics. Consult us, or our representatives before use, to confirm that the information in this datasheet is up to date.
2. The information in this datasheet is intended to illustrate the operation and characteristics of our products. We neither make warranties or representations with respect to the accuracy or completeness of the information contained in this datasheet nor grant any license to any intellectual property rights of ours or any third party concerning with the information in this datasheet.
3. Applicable export control laws and regulations should be complied and the procedures required by such laws and regulations should also be followed, when the product or any information contained in this datasheet is exported.
4. The product is neither intended nor warranted for use in equipment of systems which require extremely high levels of quality and/or reliability and/or a malfunction or failure which may cause loss of human life, bodily injury, serious property damage including but not limited to devices or equipment used in 1) nuclear facilities, 2) aerospace industry, 3) medical facilities, 4) automobile industry and other transportation industry and 5) safety devices and safety equipment to control combustions and explosions. Do not use the product for the above use unless agreed by us in writing in advance.
5. Although we make continuous efforts to improve the quality and reliability of our products; nevertheless Semiconductors are likely to fail with a certain probability. So in order to prevent personal injury and/or property damage resulting from such failure, customers are required to incorporate adequate safety measures in their designs, such as system fail safes, redundancy and fire prevention features.
6. Our products are not designed to be Radiation-resistant.
7. Please use the product listed in this datasheet within the specified ranges.
8. We assume no responsibility for damage or loss due to abnormal use.
9. All rights reserved. No part of this datasheet may be copied or reproduced unless agreed by Torex Semiconductor Ltd in writing in advance.

TOREX SEMICONDUCTOR LTD.

Данный компонент на территории Российской Федерации

Вы можете приобрести в компании MosChip.

Для оперативного оформления запроса Вам необходимо перейти по данной ссылке:

<http://moschip.ru/get-element>

Вы можете разместить у нас заказ для любого Вашего проекта, будь то серийное производство или разработка единичного прибора.

В нашем ассортименте представлены ведущие мировые производители активных и пассивных электронных компонентов.

Нашей специализацией является поставка электронной компонентной базы двойного назначения, продукции таких производителей как XILINX, Intel (ex.ALTERA), Vicor, Microchip, Texas Instruments, Analog Devices, Mini-Circuits, Amphenol, Glenair.

Сотрудничество с глобальными дистрибьюторами электронных компонентов, предоставляет возможность заказывать и получать с международных складов практически любой перечень компонентов в оптимальные для Вас сроки.

На всех этапах разработки и производства наши партнеры могут получить квалифицированную поддержку опытных инженеров.

Система менеджмента качества компании отвечает требованиям в соответствии с ГОСТ Р ИСО 9001, ГОСТ РВ 0015-002 и ЭС РД 009

Офис по работе с юридическими лицами:

105318, г.Москва, ул.Щербаковская д.3, офис 1107, 1118, ДЦ «Щербаковский»

Телефон: +7 495 668-12-70 (многоканальный)

Факс: +7 495 668-12-70 (доб.304)

E-mail: info@moschip.ru

Skype отдела продаж:

moschip.ru

moschip.ru_4

moschip.ru_6

moschip.ru_9