

Model 317

HFF HCMOS VCXO

Features

- Ceramic Surface Mount Package
- Ultra-Low Phase Jitter Performance
- High Frequency Fundamental Crystal Design
- Frequency Range 100 – 170MHz *
- +3.3V Operation
- Output Enable Standard
- Tape and Reel Packaging, EIA-418

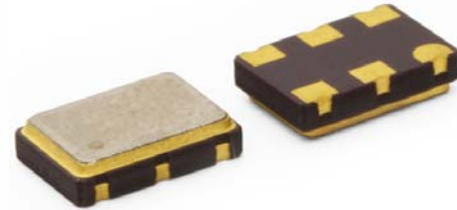

Part Dimensions:
7.0 × 5.0 × 2.0mm • 178.462mg

Applications

- Small Cells
- Wireless Communication
- Broadband Access
- SONET/SDH/DWDM
- Base Stations
- Ethernet/GbE/SyncE
- Digital Video
- Test and Measurement

Standard Frequencies

- 100.00MHz
- 122.88MHz
- 125.00MHz
- 153.60MHz
- 155.52MHz
- 156.25MHz
- 166.00MHz

* Check with factory for availability.

Description

CTS Model 317 is a low cost, small size, high performance VCXO. Employing the latest IC technology, coupled with a high frequency fundamental crystal, M317 has excellent stability and low jitter/phase noise performance.

Ordering Information

| Model | Supply Voltage | Absolute Pull Range | Frequency Stability | Temperature Range | Frequency Code [MHz] | Packaging |
|-------|----------------|---------------------|---|--------------------------------------|-------------------------------------|----------------|
| 317 | L | B | 3 | I | XXX or XXXX | T |
| | Code Voltage | | Code Stability | | Code Frequency | |
| | L +3.3V ±5% | | 3 ±50ppm 5 ±25ppm 6 ±20ppm ¹ | | Product Frequency Code ² | |
| | | Code APR | | Code Temp. Range | | Code Packing |
| | | B ±50ppm | | C -20°C to +70°C I -40°C to +85°C | | T 1k pcs./reel |

Notes:

- 1] Only available with "C" temperature range.
- 2] Refer to document 016-1454-0, Frequency Code Tables.
3-digits for frequencies <100MHz, 4-digits for frequencies 100MHz or greater.

**Not all performance combinations and frequencies may be available.
Contact your local CTS Representative or CTS Customer Service for availability.**

Electrical Specifications

Operating Conditions

| PARAMETER | SYMBOL | CONDITIONS | MIN | TYP | MAX | UNIT |
|-------------------------|-----------|--|------------|-----|------------|------------------|
| Maximum Supply Voltage | V_{CC} | - | -0.5 | - | 5.0 | V |
| Maximum Control Voltage | V_C | - | -0.5 | - | V_{CC} | V |
| Supply Voltage | V_{CC} | $\pm 5\%$ | 3.14 | 3.3 | 3.47 | V |
| Supply Current | I_{CC} | Typical @ $C_L = 15$ pF, $T_A = +25^\circ\text{C}$ | - | 20 | 30 | mA |
| Output Load | C_L | - | - | - | 15 | pF |
| Operating Temperature | T_A | - | -20 -40 | +25 | +70 +85 | $^\circ\text{C}$ |
| Storage Temperature | T_{STG} | - | -40 | - | +100 | $^\circ\text{C}$ |

Frequency Stability

| PARAMETER | SYMBOL | CONDITIONS | MIN | TYP | MAX | UNIT |
|---------------------------------|-------------------|---|-----|--------------|-----|-----------|
| Frequency Range | f_0 | - | | 100 - 170 | | MHz |
| Frequency Stability [Note 1] | $\Delta f/f_0$ | ± 20 ppm stability, -20°C to $+70^\circ\text{C}$ only | | 20, 25 or 50 | | \pm ppm |
| Absolute Pull Range [Note 2] | APR | - | 50 | - | - | \pm ppm |
| Aging | $\Delta f/f_{25}$ | First Year @ $+25^\circ\text{C}$, nominal V_{CC} and V_C | -3 | - | 3 | ppm |

1.] Inclusive of initial tolerance at time of shipment, changes in supply voltage, load, temperature and 1st year aging.

2.] Minimum guaranteed frequency shift from f_0 over variations in temperature, aging, power supply and load.

Output Parameters

| PARAMETER | SYMBOL | CONDITIONS | MIN | TYP | MAX | UNIT |
|------------------------|----------------------|--|------------------|--------|------------------|---------------|
| Output Type | - | - | | HCMOS | | - |
| Output Voltage Levels | V_{OH} V_{OL} | Logic '1' Level, CMOS Load Logic '0' Level, CMOS Load | $0.9V_{CC}$ - | - - | - $0.1V_{CC}$ | V |
| Output Duty Cycle | SYM | @ 50% Level | 45 | - | 55 | % |
| Rise and Fall Time | T_R, T_F | @ 20%/80% Levels | - | 1.5 | 3.0 | ns |
| Start Up Time | T_S | Application of V_{CC} | - | - | 5 | ms |
| Enable Function | | | | | | |
| Enable Input Voltage | V_{IH} | Pin 2 Logic '1', Output Enabled | $0.7V_{CC}$ | - | - | V |
| Disable Input Voltage | V_{IL} | Pin 2 Logic '0', Output Standby | - | - | $0.3V_{CC}$ | V |
| Standby Current | I_{STB} | Pin 2 Logic '0', Output Standby | - | - | 10 | μA |
| Enable Time | T_{PLZ} | Pin 2 Logic '1' | - | - | 2 | ms |
| Phase Jitter, RMS | t_{jrms} | Bandwidth 12 kHz - 20 MHz | - | 50 | 500 | fs |
| Phase Noise | - | See Typical Plots | - | - | - | - |

Enable Truth Table

| Pin 2 | Pin 4 |
|-----------|-----------|
| Logic '1' | Output |
| Open | Output |
| Logic '0' | High Imp. |

Electrical Specifications

Control Voltage

| PARAMETER | SYMBOL | CONDITIONS | MIN | TYP | MAX | UNIT |
|---------------------|----------------|-----------------------------------|------|-------------|------|-------|
| Control Voltage | V_C | - | 0.30 | 1.65 | 3.00 | V |
| Frequency Deviation | $\Delta f/f_0$ | $V_C = 0.0V$ | | -155 to -75 | | ppm |
| | | $V_C = 3.3V$ | | 75 to 155 | | |
| Linearity | L | Best Straight Line Fit | - | 5 | 10 | % |
| Gain Transfer | K_V | Pull Sensitivity; @ +1.65V, +25°C | - | 65 | - | ppm/V |
| Input Impedance | Z_{V_C} | - | 100 | - | - | kOhms |
| Modulation Roll-off | - | @ -3dB | 20 | - | - | kHz |
| Transfer Function | - | - | | Positive | | - |

Test Circuit

HCMOS



Output Waveform

HCMOS



Electrical Specifications

Performance Data

Frequency Deviation – Over Temperature [typical]

122.88MHz, $V_{CC} = 3.3V$, $V_C = 1.65V$

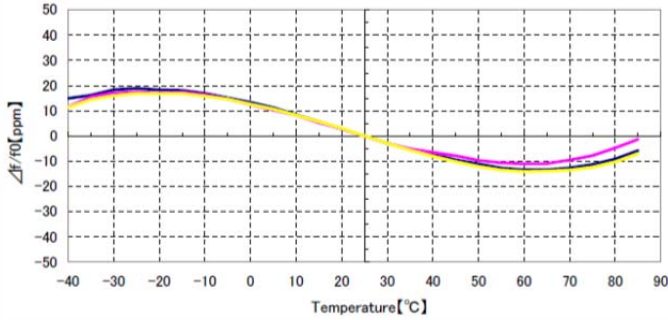

156.25MHz, $V_{CC} = 3.3V$, $V_C = 1.65V$

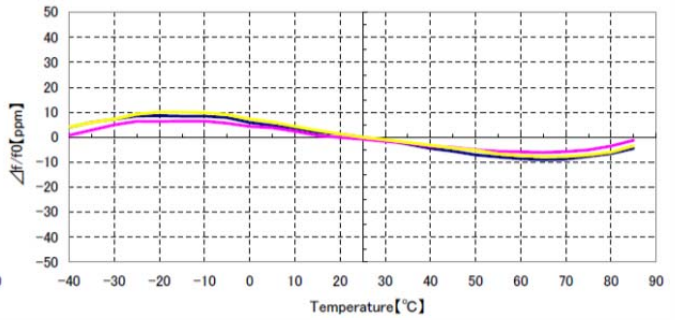

Frequency Deviation – Pulling Range [typical]

122.88MHz, $V_{CC} = 3.3V$, $T_A = +25^\circ V$

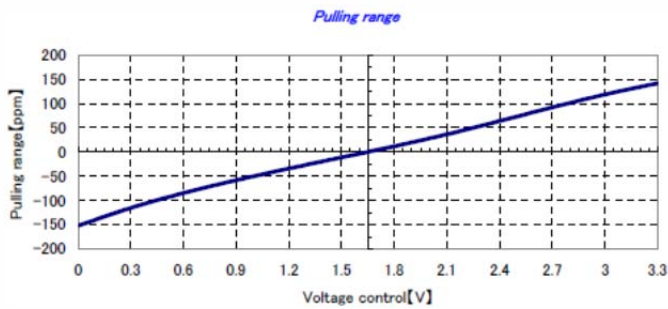

156.25MHz, $V_{CC} = 3.3V$, $T_A = +25^\circ V$

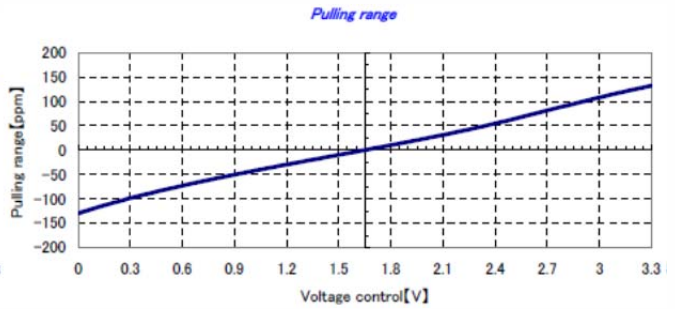

Frequency Deviation – Gain Transfer [typical]

122.88MHz, $V_{CC} = 3.3V$, $T_A = +25^\circ V$

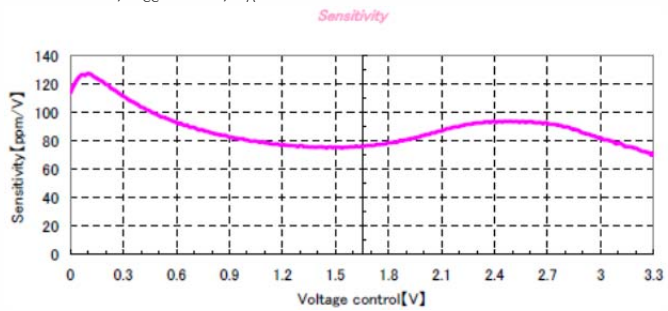

156.25MHz, $V_{CC} = 3.3V$, $T_A = +25^\circ V$

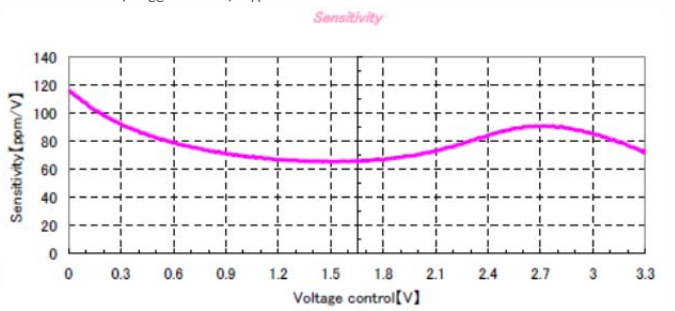



Electrical Specifications

Performance Data

Phase Noise [typical]

122.88MHz, $V_{CC} = 3.3V$, $V_C = 1.65V$, $T_A = +25^\circ C$



156.25MHz, $V_{CC} = 3.3V$, $V_C = 1.65V$, $T_A = +25^\circ C$



Mechanical Specifications

Package Drawing



Marking Information

- ** - Manufacturing Site Code.
- D – Date Code. See Table I for codes.
- ST – Frequency Stability/Temperature Code. [Refer to Ordering Information]
- V – Voltage Code. L = 3.3V
- xxxx – Frequency Code. 4-digits required for frequencies 100MHz and above. [See document 016-1454-0, Frequency Code Tables.]

Recommended Pad Layout



Notes

- Termination pads (e4). Barrier-plating is nickel [Ni] with gold [Au] flash plate.
- Reflow conditions per JEDEC J-STD-020; +260°C maximum, 20 seconds.
- MSL = 1.

Pin Assignments

| Pin | Symbol | Function |
|-----|-----------------|-------------------|
| 1 | V _C | Control Voltage |
| 2 | EOH | Enable |
| 3 | GND | Circuit & Package |
| 4 | Output | RF Output |
| 5 | N.C. | No Connect |
| 6 | V _{CC} | Supply Voltage |

Table I - Date Code

| YEAR | | MONTH | | | | | | | | | | | | | | |
|------|------|-------|------|------|-----|-----|-----|-----|-----|-----|-----|-----|-----|---|---|---|
| | | JAN | FEB | MAR | APR | MAY | JUN | JUL | AUG | SEP | OCT | NOV | DEC | | | |
| 2001 | 2005 | 2009 | 2013 | 2017 | A | B | C | D | E | F | G | H | J | K | L | M |
| 2002 | 2006 | 2010 | 2014 | 2018 | N | P | Q | R | S | T | U | V | W | X | Y | Z |
| 2003 | 2007 | 2011 | 2015 | 2019 | a | b | c | d | e | f | g | h | j | k | l | m |
| 2004 | 2008 | 2012 | 2016 | 2020 | n | p | q | r | s | t | u | v | w | x | y | z |

Packaging - Tape and Reel

Tape Drawing

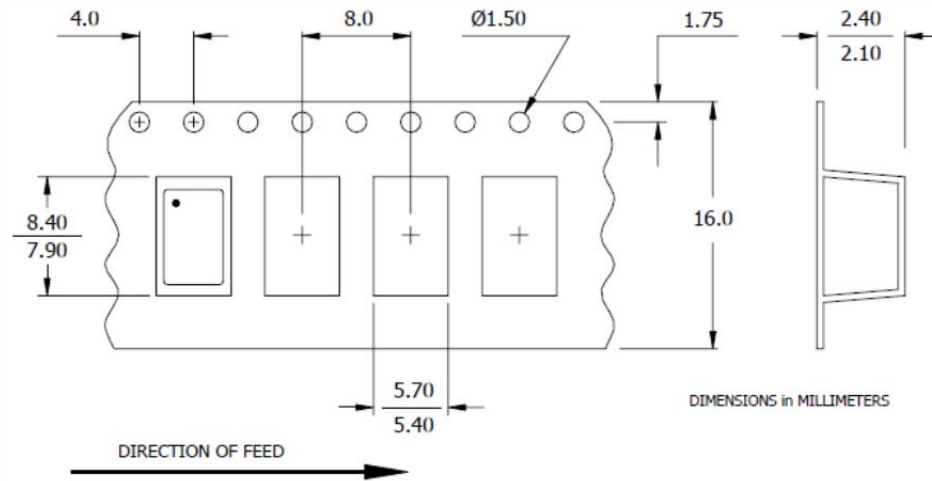

Reel Drawing

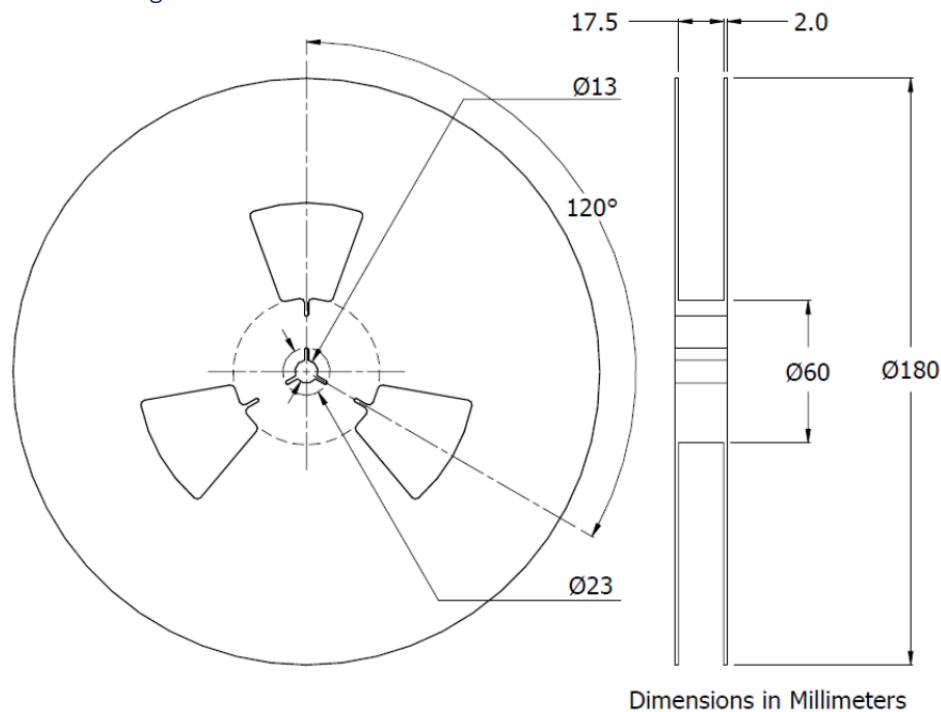

Notes

1. Device quantity is 1k pieces maximum per 180mm reel.
2. Complete CTS part number, frequency value and date code information must appear on reel and carton labels.

Данный компонент на территории Российской Федерации

Вы можете приобрести в компании MosChip.

Для оперативного оформления запроса Вам необходимо перейти по данной ссылке:

<http://moschip.ru/get-element>

Вы можете разместить у нас заказ для любого Вашего проекта, будь то серийное производство или разработка единичного прибора.

В нашем ассортименте представлены ведущие мировые производители активных и пассивных электронных компонентов.

Нашей специализацией является поставка электронной компонентной базы двойного назначения, продукции таких производителей как XILINX, Intel (ex.ALTERA), Vicor, Microchip, Texas Instruments, Analog Devices, Mini-Circuits, Amphenol, Glenair.

Сотрудничество с глобальными дистрибьюторами электронных компонентов, предоставляет возможность заказывать и получать с международных складов практически любой перечень компонентов в оптимальные для Вас сроки.

На всех этапах разработки и производства наши партнеры могут получить квалифицированную поддержку опытных инженеров.

Система менеджмента качества компании отвечает требованиям в соответствии с ГОСТ Р ИСО 9001, ГОСТ РВ 0015-002 и ЭС РД 009

Офис по работе с юридическими лицами:

105318, г.Москва, ул.Щербаковская д.3, офис 1107, 1118, ДЦ «Щербаковский»

Телефон: +7 495 668-12-70 (многоканальный)

Факс: +7 495 668-12-70 (доб.304)

E-mail: info@moschip.ru

Skype отдела продаж:

moschip.ru

moschip.ru_4

moschip.ru_6

moschip.ru_9