



28 Gbps, 4:1 MUX WITH PROGRAMMABLE OUTPUT VOLTAGE

Typical Applications

The HMC854LC5 is ideal for:

- SONET OC 192
- Broadband Test & Measurement
- Serial Data Transmission up to 28 Gbps
- Mux modes:
 - 4:1 @ 28 Gbps NRZ,
 - 2:1 @ 14 Gbps RZ and NRZ
- FPGA Interfacing

Features

- Differential & Single-Ended Operation
- Half Rate Clock Input
- Quarter Rate Reference Clock Output
- Fast Rise and Fall Times: 16 ps
- Low Power Consumption: 510 mW typ.
- Programmable Differential
 - Output Voltage Swing: 700 - 1250 mV
- Single Supply: -3.3 V
- 32 Lead Ceramic 5x5 mm SMT Package: 25 mm²

Functional Diagram

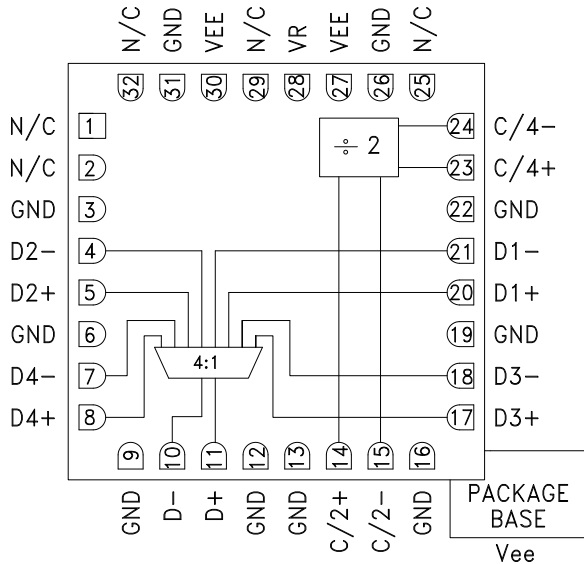

General Description

The HMC854LC5 is a 4:1 multiplexer designed for 28Gbps data serialization. The mux latches the four differential inputs on a rising edge of the input clock. The device uses both rising and falling edges of the half-rate clock to serialize the data. A quarter-rate clock output generated on chip can be used to synchronize data into the mux. The mux is DC coupled supporting broadband operation.

All clock and data inputs to the HMC854LC5 are CML and terminated on-chip with 50 ohms to the positive supply, GND, and may be DC or AC coupled. The differential outputs are source terminated to 50 ohms and may also be AC or DC coupled. Outputs can be connected directly to a 50 ohm ground terminated system, or drive devices with CML logic input. The HMC854LC5 also features an output level control pin, VR, which allows for loss compensation or signal level optimization. The HMC854LC5 operates from a single -3.3 V supply and is available in ROHS compliant 5x5 mm SMT package.

Electrical Specifications, $T_A = +25\text{ }^\circ\text{C}$, $V_{ee} = -3.3\text{ V}$, $VR = 0\text{ V}$

Parameter	Conditions	Min.	Typ.	Max	Units
Power Supply Voltage	$T > 75\text{ }^\circ\text{C}$	-3.6 -3.45	-3.3	-3.0	V V
Power Supply Current			155		mA
Maximum Data Rate			28		Gbps
Maximum Clock Rate, Half Rate			14		GHz
Input Voltage Range, CML		-1.5		0.5	V
Input Differential Voltage		100		2000	mV
Output Rise / Fall Time	Differential, 20% - 80%		16		ps
Random Jitter Jr	rms		0.5		ps rms
Deterministic Jitter, Jd	peak-to-peak, 2 ¹⁵ -1 PRBS input [1]		4		ps, p-p

Information furnished by Analog Devices is believed to be accurate and reliable. However, no responsibility is assumed by Analog Devices for its use, nor for any infringements of patents or other rights of third parties that may result from its use. Specifications subject to change without notice. No license is granted by implication or otherwise under any patent or patent rights of Analog Devices. Trademarks and registered trademarks are the property of their respective owners.

For price, delivery, and to place orders: Analog Devices, Inc., One Technology Way, P.O. Box 9106, Norwood, MA 02062-9106
Phone: 781-329-4700 • Order online at www.analog.com
Application Support: Phone: 1-800-ANALOG-D



28 Gbps, 4:1 MUX WITH PROGRAMMABLE OUTPUT VOLTAGE

Electrical Specifications (continued)

Parameter	Conditions	Min.	Typ.	Max	Units
Input Return Loss	Frequency <12 GHz		10		dB
Output Amplitude	Single-Ended, peak-to-peak		500		mVp-p
	Differential, peak-to-peak		1000		mVp-p
Output High Voltage			0		mV
Output Low Voltage			-500		mV
Output Return Loss	Frequency <12 GHz		10		dB
Propagation Delay Clock to Data, Td _{pd}			126		ps
Propagation Delay Clock to Output Clock, Tc _{pd}			135		ps
Set Up Time, t _s			-41		ps
Hold Time, t _h			50		ps

DC Current vs. Supply Voltage [1] [2]

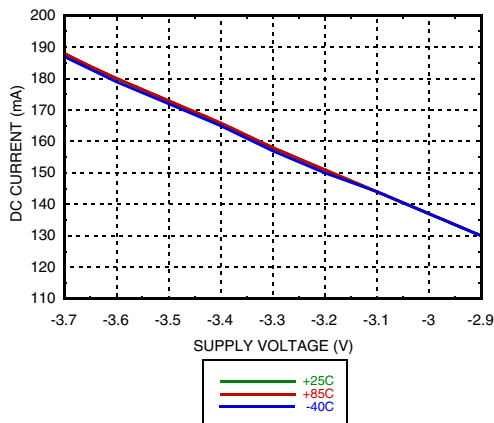

Output Differential vs. Supply Voltage [1] [2]

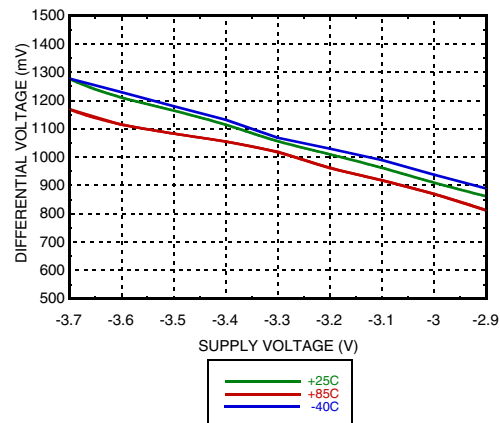

Output Differential vs. VR [2] [3]

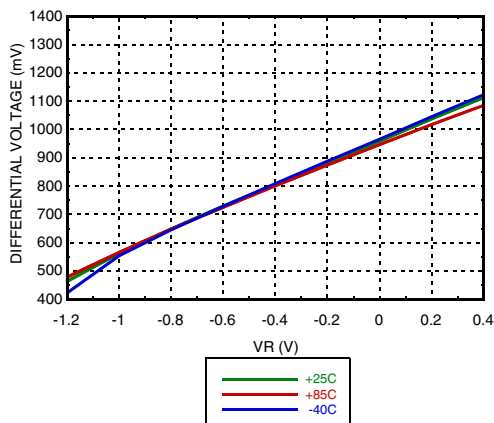

Delay vs. Temperature [1] [3]

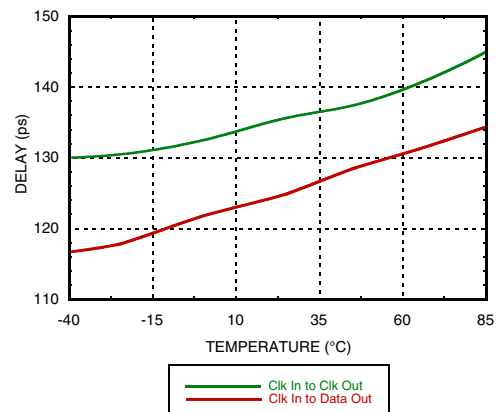

[1] VR = 0.0 V

[2] Frequency = 28 Gbps

 [3] V_{ee} = -3.3 V



**28 Gbps, 4:1 MUX
WITH PROGRAMMABLE OUTPUT VOLTAGE**

Rise / Fall Time vs. Supply Voltage [1] [2]

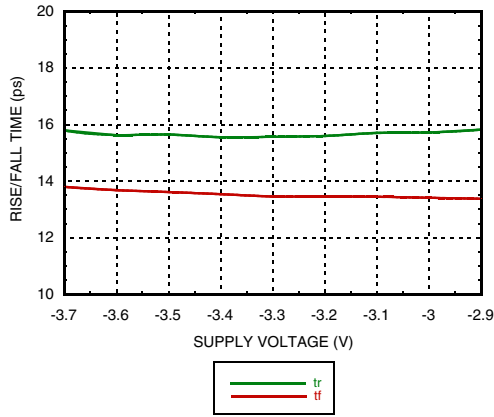

Rise / Fall Time vs. VR [2] [4]

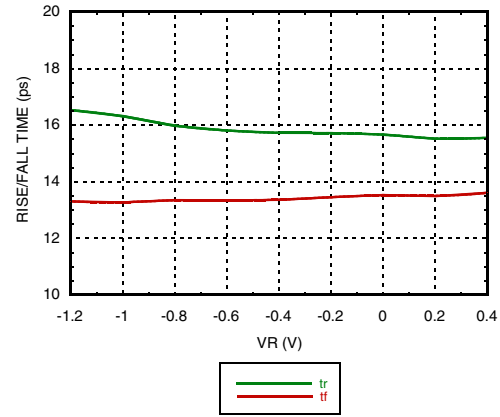

Input Return Loss vs. Frequency [1] [3] [4]

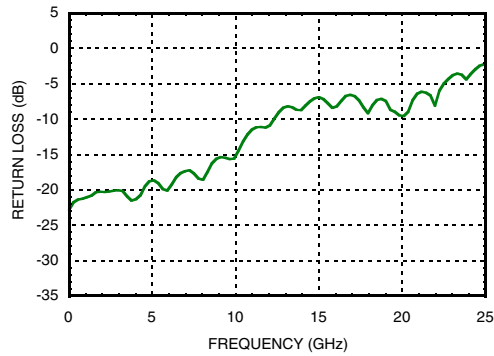

Output Return Loss vs. Frequency [3]

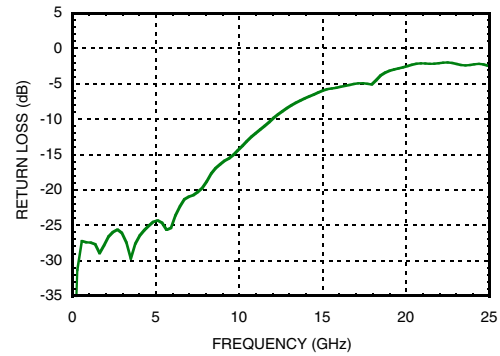

[1] VR = 0.0 V

[2] Frequency = 28 Gbps

[3] Device measured on evaluation board with port extensions

[4] Vee = -3.3 V

Information furnished by Analog Devices is believed to be accurate and reliable. However, no responsibility is assumed by Analog Devices for its use, nor for any infringements of patents or other rights of third parties that may result from its use. Specifications subject to change without notice. No license is granted by implication or otherwise under any patent or patent rights of Analog Devices. Trademarks and registered trademarks are the property of their respective owners.

For price, delivery, and to place orders: Analog Devices, Inc., One Technology Way, P.O. Box 9106, Norwood, MA 02062-9106 Phone: 781-329-4700 • Order online at www.analog.com Application Support: Phone: 1-800-ANALOG-D

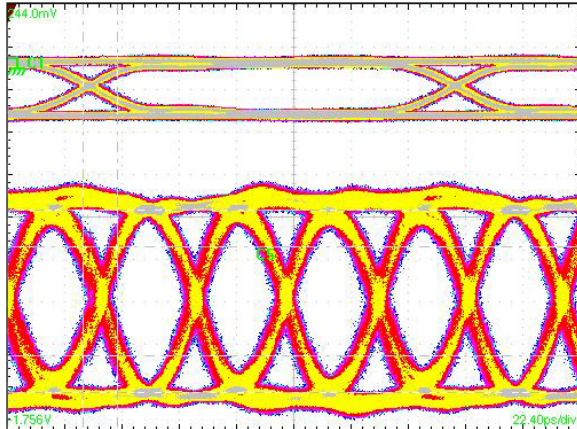
**28 Gbps, 4:1 MUX
WITH PROGRAMMABLE OUTPUT VOLTAGE****Eye Diagram @ 28 Gbps****Test Conditions:**

Single ended 550 mV data and 400 mV clock inputs. Pattern generated with four $2^{15} - 1$ PN patterns applied to the inputs resulting in a Quasi-Periodic PRBS pattern at 28 Gbps. Measured using Tektronix CSA 8000

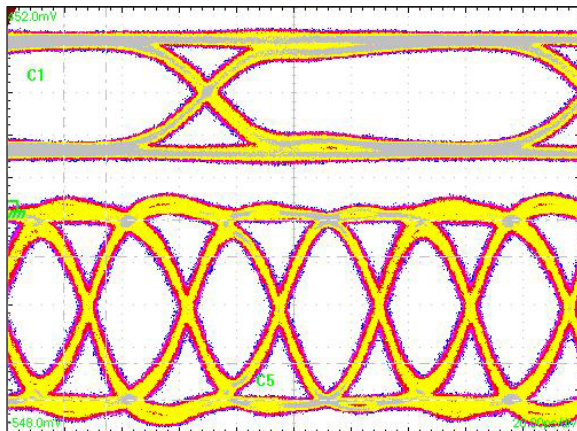
Eye Diagram @ 30 Gbps**Test Conditions:**

Single ended 550 mV data and 400 mV clock inputs. Pattern generated with four $2^{15} - 1$ PN patterns applied to the inputs resulting in a Quasi-Periodic PRBS pattern at 30 Gbps. Measured using Tektronix CSA 8000



**28 Gbps, 4:1 MUX
WITH PROGRAMMABLE OUTPUT VOLTAGE**

Timing Diagram

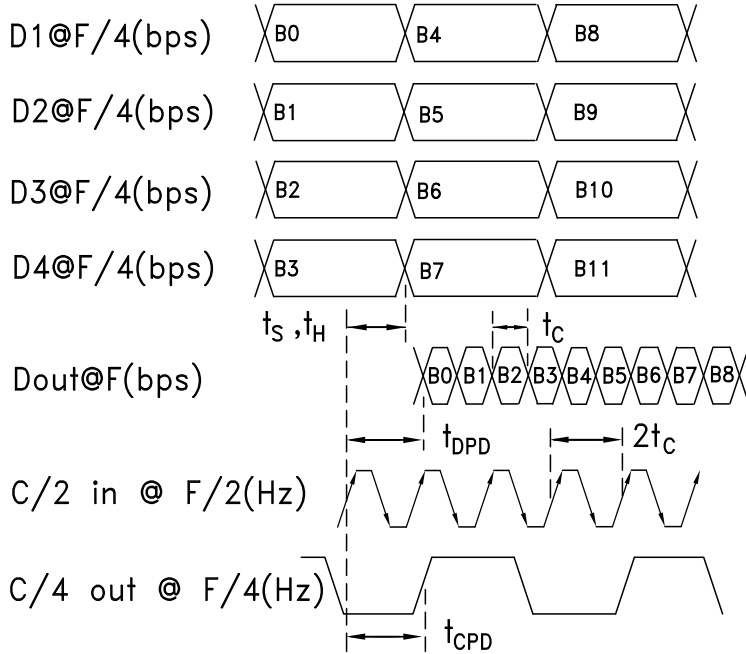



28 Gbps, 4:1 MUX WITH PROGRAMMABLE OUTPUT VOLTAGE

Absolute Maximum Ratings

Power Supply Voltage (Vee)	-3.75 V to +0.5 V
Input Signals	-2 V to +0.5 V
Output Signals	-1.5 V to +0.5 V
Junction Temperature	125 °C
Continuous Pdiss (T = 85 °C) (derate 33 mW/°C above 85 °C)	1.33 W
Thermal Resistance (R _{th j-p}) Worse case device to package paddle	30 °C/W
Storage Temperature	-65 °C to +150 °C
Operating Temperature	-40 °C to +85 °C
ESD Sensitivity (HBM)	Class 1C



ELECTROSTATIC SENSITIVE DEVICE
OBSERVE HANDLING PRECAUTIONS

Outline Drawing

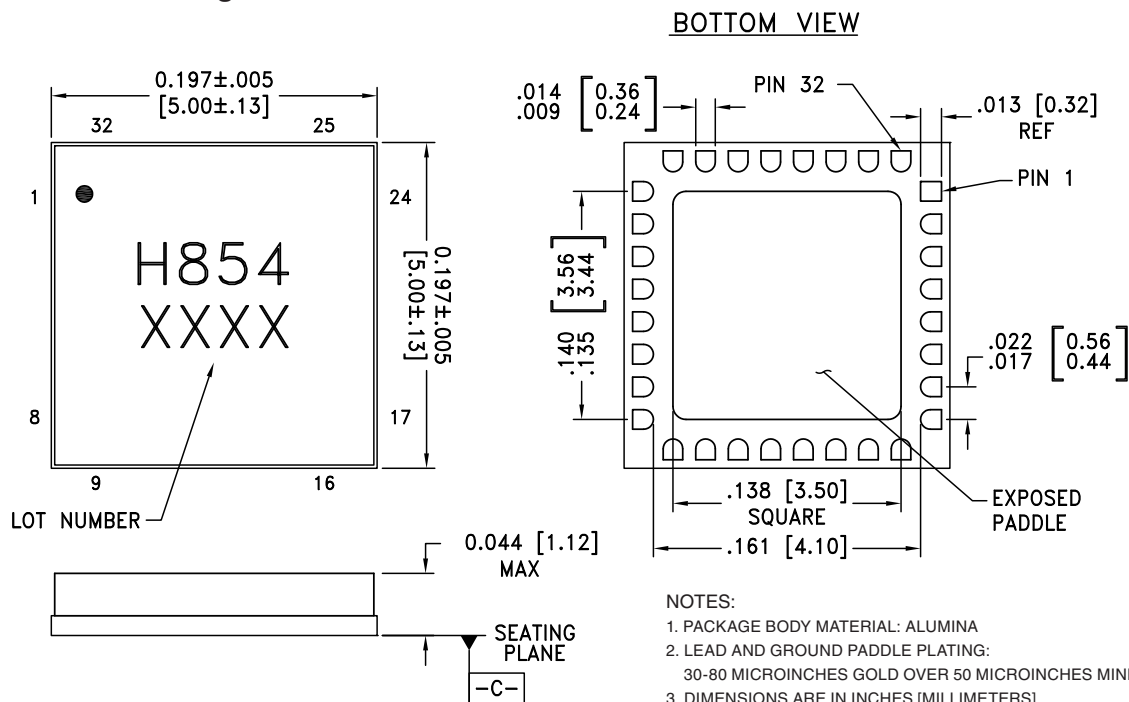

Package Information

Part Number	Package Body Material	Lead Finish	MSL Rating	Package Marking [2]
HMC854LC5	Alumina, White	Gold over Nickel	MSL3 [1]	H854 XXXX

[1] Max peak reflow temperature of 260 °C

[2] 4-Digit lot number XXXX



28 Gbps, 4:1 MUX WITH PROGRAMMABLE OUTPUT VOLTAGE

Pin Descriptions

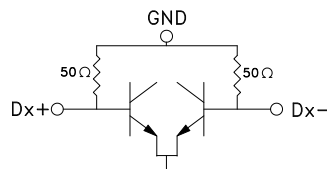
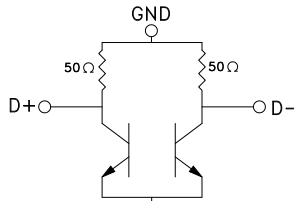
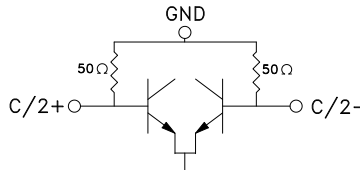
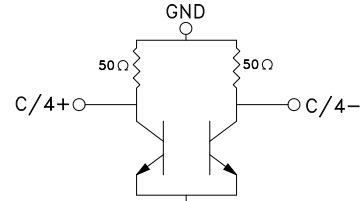
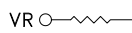
Pin Number	Function	Description	Interface Schematic
1, 2, 25, 29, 32	N/C	No connection necessary. These pins may be connected to RF/DC ground without affecting performance.	
3, 6, 9, 12, 13, 16, 19, 22, 26, 31	GND	These pins must be connected to a high quality RF/DC ground.	
4, 5, 7, 8, 17, 18, 20, 21	D2-, D2+ D4-, D4+ D3+, D3- D1+, D1-	Differential Data Inputs: Current Mode Logic(CML) referenced to positive supply	
10, 11	D-, D+	Differential Data Outputs: Current Mode Logic (CML) referenced to positive supply	
14, 15	C/2+, C/2-	Differential Half-Rate Clock Inputs: Current Mode Logic (CML) referenced to positive supply	
23, 24	C/4+, C/4-	Differential Quarter-Rate Clock Outputs: Current Mode Logic(CML) referenced to positive supply	
27, 30, Package Base	Vee	These pins and the exposed paddle must be connected to the negative voltage supply.	
28	VR	Output level control. Output level may be increased or decreased by applying a voltage to VR per "Output Differential vs. VR" plot.	



**28 Gbps, 4:1 MUX
WITH PROGRAMMABLE OUTPUT VOLTAGE**

Evaluation PCB

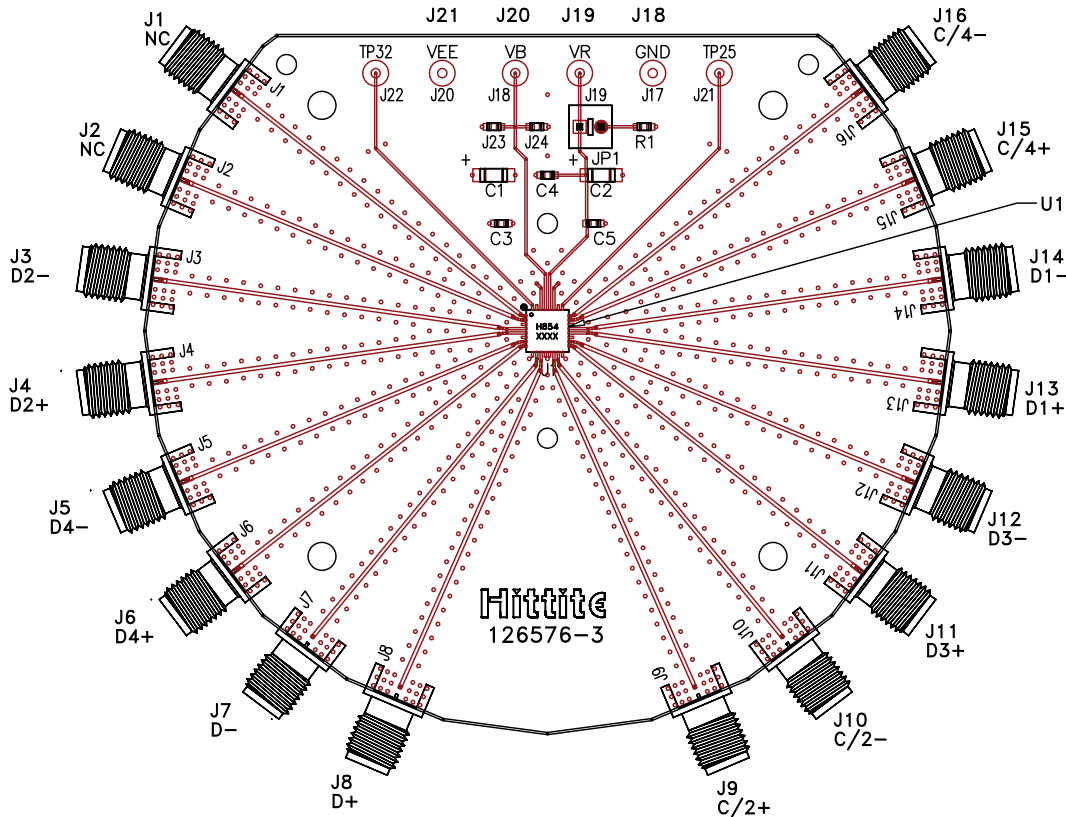

List of Materials for Evaluation PCB 126578 [1]

Item	Description
J7 - J10	PCB Mount K RF Connectors
J3 - J6, J11 - J16	PCB Mount SMA RF Connectors
J18 - J21	DC Pin
JP1	2 Position Header with Shunt
C1, C2	4.7 µF Capacitor, Tantalum
C3 - C5	100 pF Capacitor, 0402 Pkg.
R1	10 Ohm Resistor, 0603 Pkg.
U1	HMC854LC5 28 Gbps 4:1 Mux
PCB [2]	126576 Evaluation Board

[1] Reference this number when ordering complete evaluation PCB

[2] Circuit Board Material: Arlon 25FR or Rogers 4350

The circuit board used in the application should use RF circuit design techniques. Signal lines should have 50 ohm impedance while the package ground leads should be connected directly to the ground plane similar to that shown. The exposed metal package base must be connected to Vee. A sufficient number of via holes should be used to connect the top and bottom ground planes. The evaluation circuit board shown is available from Hittite upon request. Install jumper on JP1 to short VR to GND for normal operation.



**28 Gbps, 4:1 MUX
WITH PROGRAMMABLE OUTPUT VOLTAGE**

Application Circuit

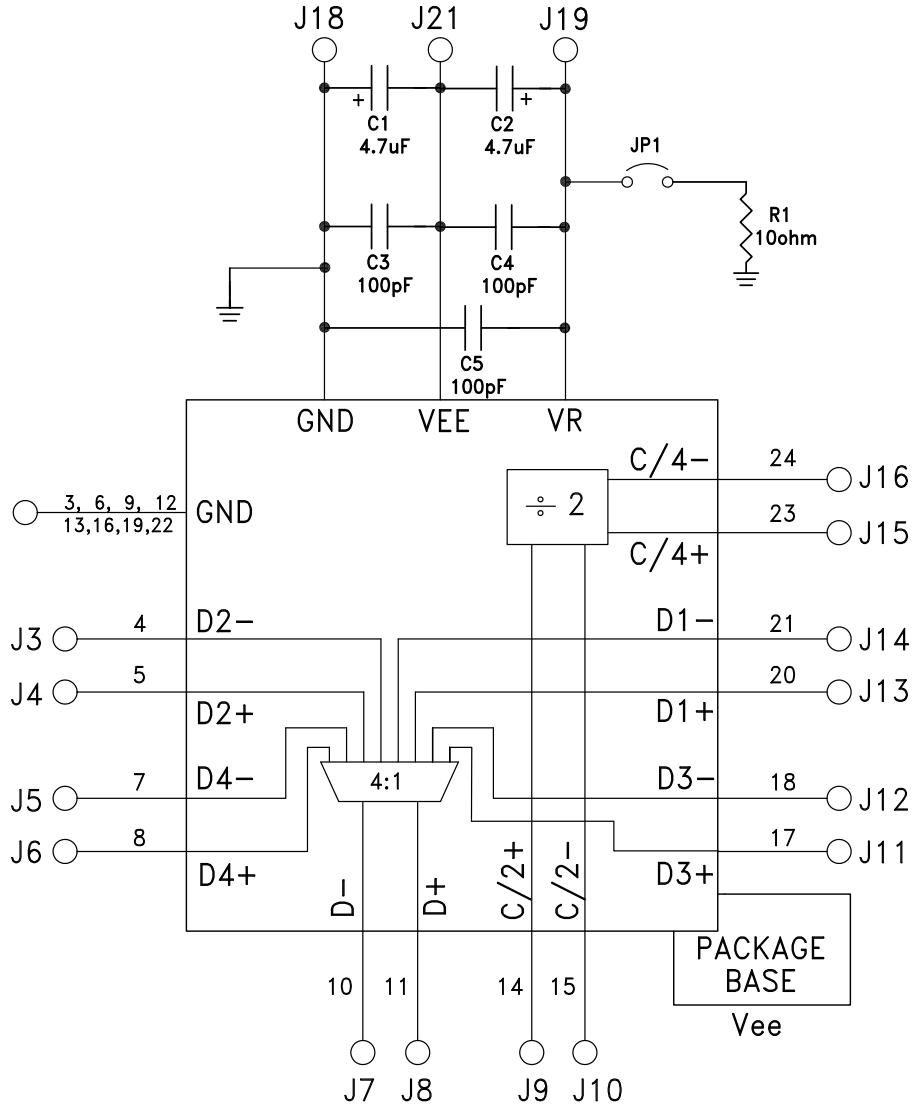

**28 Gbps, 4:1 MUX
WITH PROGRAMMABLE OUTPUT VOLTAGE****Notes:**

Данный компонент на территории Российской Федерации

Вы можете приобрести в компании MosChip.

Для оперативного оформления запроса Вам необходимо перейти по данной ссылке:

<http://moschip.ru/get-element>

Вы можете разместить у нас заказ для любого Вашего проекта, будь то серийное производство или разработка единичного прибора.

В нашем ассортименте представлены ведущие мировые производители активных и пассивных электронных компонентов.

Нашей специализацией является поставка электронной компонентной базы двойного назначения, продукции таких производителей как XILINX, Intel (ex.ALTERA), Vicor, Microchip, Texas Instruments, Analog Devices, Mini-Circuits, Amphenol, Glenair.

Сотрудничество с глобальными дистрибьюторами электронных компонентов, предоставляет возможность заказывать и получать с международных складов практически любой перечень компонентов в оптимальные для Вас сроки.

На всех этапах разработки и производства наши партнеры могут получить квалифицированную поддержку опытных инженеров.

Система менеджмента качества компании отвечает требованиям в соответствии с ГОСТ Р ИСО 9001, ГОСТ РВ 0015-002 и ЭС РД 009

Офис по работе с юридическими лицами:

105318, г.Москва, ул.Щербаковская д.3, офис 1107, 1118, ДЦ «Щербаковский»

Телефон: +7 495 668-12-70 (многоканальный)

Факс: +7 495 668-12-70 (доб.304)

E-mail: info@moschip.ru

Skype отдела продаж:

moschip.ru

moschip.ru_4

moschip.ru_6

moschip.ru_9