

Features

- Formerly **FulTec** brand
- Extremely high speed performance
- Low impedance
- Two TBU® protectors in one small package
- Very high bandwidth, GHz compatible
- Simple, superior circuit protection
- RoHS compliant*, UL Recognized

Applications

- xDSL (ADSL, VDSL, VDSL2)
- High Data Rate Interface IC protection (LVDS, HDMI, etc.)
- Industrial sensors and controls
- General electronics

P40-G Series TBU® High-Speed Protectors

Transient Blocking Units - TBU® Devices

Bourns® Model P40-G products are high-speed bidirectional protection components, constructed using MOSFET semiconductor technology, designed to protect against faults caused by short circuits, AC power cross, induction and lightning surges.

The TBU® high-speed protector, triggering as a function of the MOSFET, blocks surges and provides an effective barrier behind which sensitive electronics are not exposed to large voltages or currents during surge events. The TBU® device is provided in a surface mount DFN package and meets industry standard requirements such as RoHS and Pb Free solder reflow profiles.

Agency Approval

UL recognized component File # E315805.

Industry Standards

Description		Model
Telcordia	GR-1089	P40-G
ITU-T	K.20, K.20E, K.21, K.21E, K.45	

Absolute Maximum Ratings ($T_{amb} = 25\text{ }^{\circ}\text{C}$)

Symbol	Parameter	Value	Unit
V_{imp}	Maximum protection voltage for impulse faults with rise time $\geq 1\text{ }\mu\text{sec}$	40	V
V_{rms}	Maximum protection voltage for continuous V_{rms} faults	28	V
T_{op}	Operating temperature range	-40 to +85	$^{\circ}\text{C}$
T_{stg}	Storage temperature range	-65 to +150	$^{\circ}\text{C}$

Electrical Characteristics ($T_{amb} = 25\text{ }^{\circ}\text{C}$)

Symbol	Parameter	Min.	Typ.	Max.	Unit
I_{op}	Maximum current through the device that will not cause current blocking			240	mA
$I_{trigger}$	Typical current for the device to go from normal operating state to protected state		350		mA
I_{out}	Maximum current through the device			480	mA
R_{device}	Series resistance of the TBU® device		3.6	4.2	Ω
R_{bal}	Line-to-line series resistance difference between two TBU® devices			5	%
t_{block}	Maximum time for the device to go from normal operating state to protected state			0.2	μs
$I_{quiescent}$	Current through the triggered TBU® device with 40 Vdc circuit voltage		0.7		mA
V_{reset}	Voltage below which the triggered TBU® device will transition to normal operating state		7		V

The P40-G Series TBU® high-speed protector is bidirectional; specifications are valid in both directions.

*RoHS Directive 2002/95/EC Jan. 27, 2003 including annex and RoHS Recast 2011/65/EU June 8, 2011. Specifications are subject to change without notice. Customers should verify actual device performance in their specific applications.

P40-G Series TBU® High-Speed Protectors

BOURNS®

Typical Performance Characteristics

V-I Characteristics

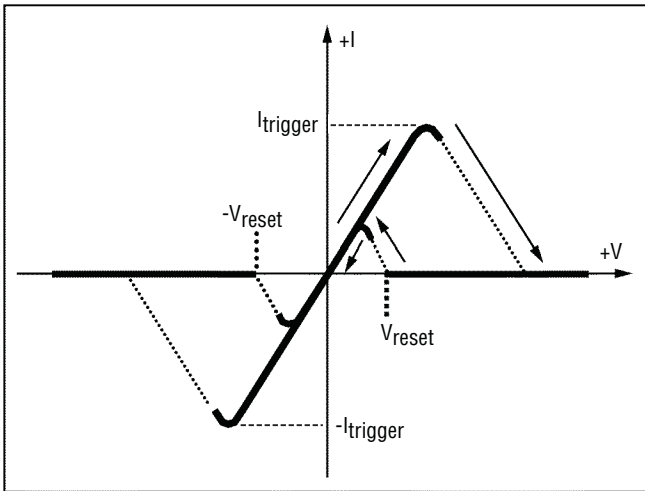

Time to Block vs. Fault Current

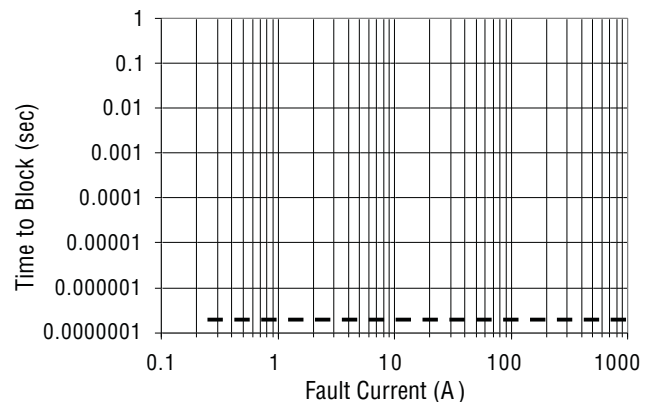

Trigger Current vs. Temperature

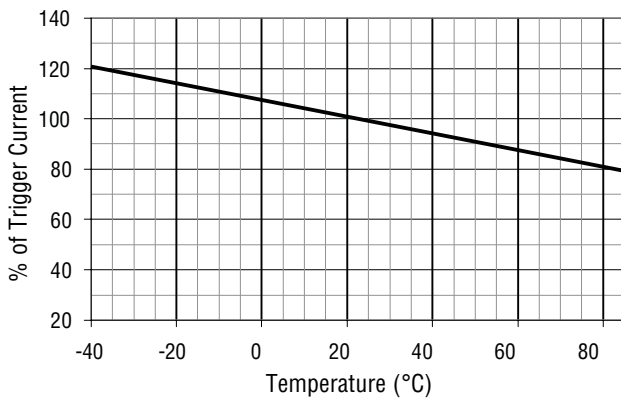

P40-G Series TBU® High-Speed Protectors

BOURNS®

Operational Characteristics

The graph below demonstrates the operational characteristics of the TBU® device. In the graph below the fault voltage, protected side voltage, and current is presented.

TEST CONFIGURATION DIAGRAM

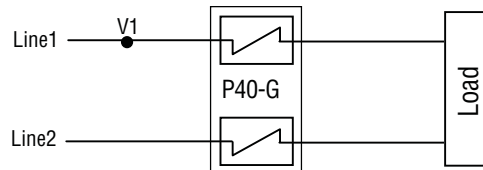

P40-G Lightning Protection 40 V

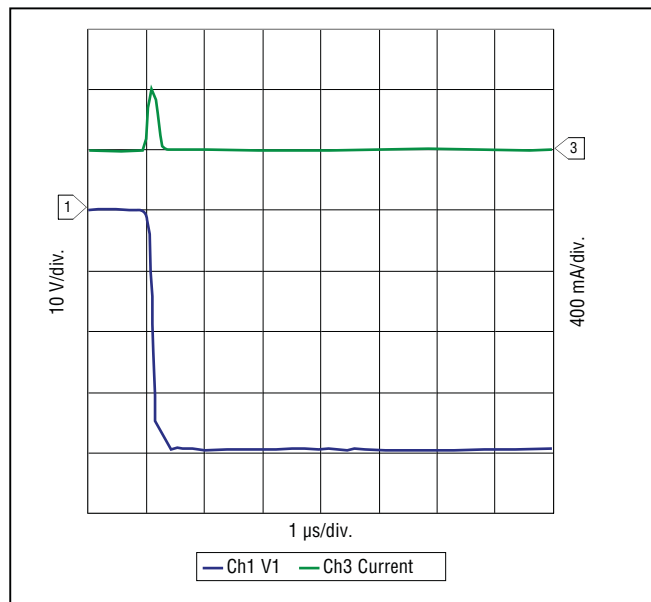

P40-G Series TBU® High-Speed Protectors

BOURNS®

Product Dimensions

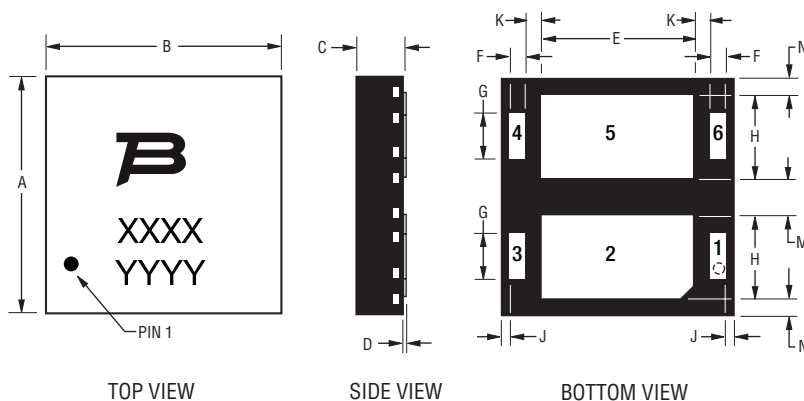

Dim.	Min.	Typ.	Max.
A	$\frac{3.90}{(.154)}$	$\frac{4.00}{(.157)}$	$\frac{4.10}{(.161)}$
B	$\frac{3.90}{(.154)}$	$\frac{4.00}{(.157)}$	$\frac{4.10}{(.161)}$
C	$\frac{0.80}{(.031)}$	$\frac{0.85}{(.033)}$	$\frac{0.90}{(.035)}$
D	$\frac{0.000}{(.000)}$	$\frac{0.025}{(.001)}$	$\frac{0.050}{(.002)}$
E	$\frac{2.55}{(.100)}$	$\frac{2.60}{(.102)}$	$\frac{2.65}{(.104)}$
F	$\frac{0.20}{(.008)}$	$\frac{0.25}{(.010)}$	$\frac{0.30}{(.012)}$
G	$\frac{0.75}{(.030)}$	$\frac{0.80}{(.031)}$	$\frac{0.85}{(.033)}$
H	$\frac{1.40}{(.055)}$	$\frac{1.45}{(.057)}$	$\frac{1.50}{(.059)}$
J	$\frac{0.10}{(.004)}$	$\frac{0.15}{(.006)}$	$\frac{0.20}{(.008)}$
K	$\frac{0.25}{(.010)}$	$\frac{0.30}{(.012)}$	$\frac{0.35}{(.014)}$
M	$\frac{0.55}{(.022)}$	$\frac{0.60}{(.024)}$	$\frac{0.65}{(.026)}$
N	$\frac{0.20}{(.008)}$	$\frac{0.25}{(.010)}$	$\frac{0.30}{(.012)}$

Recommended Pad Layout

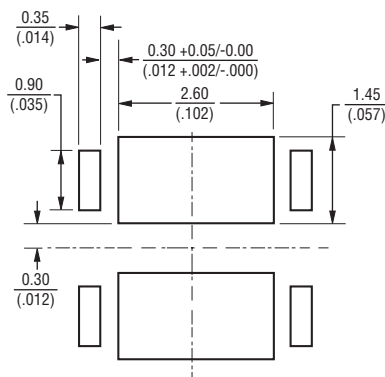

Pad Designation

Pad #	Apply
1	In1
2	NC
3	Out1
4	Out2
5	NC
6	In2

NC = Solder to PCB; do not make electrical connection, do not connect to ground.

TBU® devices have matte-tin termination finish. Suggested layout should use non-solder mask define (NSMD). Recommended stencil thickness is 0.10-0.12 mm (.004-.005 in.) with stencil opening size 0.025 mm (.0010 in.) less than the device pad size. As when heat sinking any power device, it is recommended that, wherever possible, extra PCB copper area is allowed. For minimum parasitic capacitance, do not allow any signal, ground or power signals beneath any of the pads of the device.

DIMENSIONS: $\frac{\text{MM}}{(\text{INCHES})}$

Block Diagram

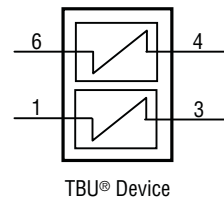

TBU® Device

Thermal Resistances

Thermal resistance using minimal pad size, where the power is the total power dissipated in the package. Additional copper pad area to be used for additional heatsinking is also recommended.

Symbol	Parameter	Value	Unit
Rth(j-a)	Junction to Package Pads (1 TBU of Pair)	250	°C/W
Rth(j-a)	Junction to Package Pads (2 TBUs of Equal Power)	180	°C/W

P40-G Series TBU® High-Speed Protectors

BOURNS®

Reflow Profile

Profile Feature	Pb-Free Assembly
Average Ramp-Up Rate (T _{smax} to T _p)	3 °C/sec. max.
Preheat	
- Temperature Min. (T _{smin})	150 °C
- Temperature Max. (T _{smax})	200 °C
- Time (t _{smin} to t _{smax})	60-180 sec.
Time maintained above:	
- Temperature (T _L)	217 °C
- Time (t _L)	60-150 sec.
Peak/Classification Temperature (T _p)	260 °C
Time within 5 °C of Actual Peak Temp. (t _p)	20-40 sec.
Ramp-Down Rate	6 °C/sec. max.
Time 25 °C to Peak Temperature	8 min. max.

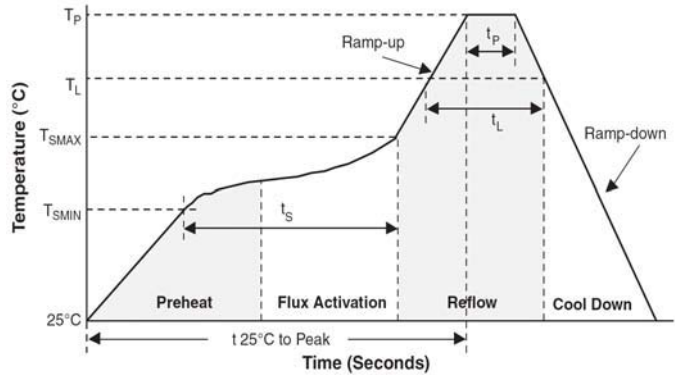

How to Order

P 40 - G 240 - WH

Form Factor _____
 P = Two TBU® protectors in one device
 Impulse Voltage Rating _____
 40 = 40 V
 Directional Indication _____
 G = Bidirectional
 Iop Indicator _____
 240 = 240 mA

Typical Part Marking

MANUFACTURER'S TRADEMARK*

MARKING NUMBER
04GC = P40-G240-WH

PIN 1

MANUFACTURING DATE CODE*

- 1ST DIGIT INDICATES THE YEAR'S 6-MONTH PERIOD.
- 2ND DIGIT INDICATES THE WEEK NUMBER IN THE 6-MONTH PERIOD.
- 3RD & 4TH DIGITS INDICATE SPECIFIC LOT FOR THE WEEK.

6-MONTH PERIOD CODES:

A = JAN-JUN 2009	C = JAN-JUN 2010	E = JAN-JUN 2011
B = JUL-DEC 2009	D = JUL-DEC 2010	F = JUL-DEC 2011

EXAMPLE: ARBC

- 1ST DIGIT 'A' = JAN-JUN 2009
- 2ND DIGIT 'R' = WEEK 18; WEEK OF APRIL 27
- 3RD & 4TH DIGITS 'BC' = LOT SPECIFIC INFORMATION

*TRANSITION FROM FULTEC TRADEMARK AND LOT CODE TO BOURNS TRADEMARK AND DATE CODE IN 2009.

P40-G Series TBU® High-Speed Protectors

BOURNS®

Packaging Specifications (per EIA468-B)

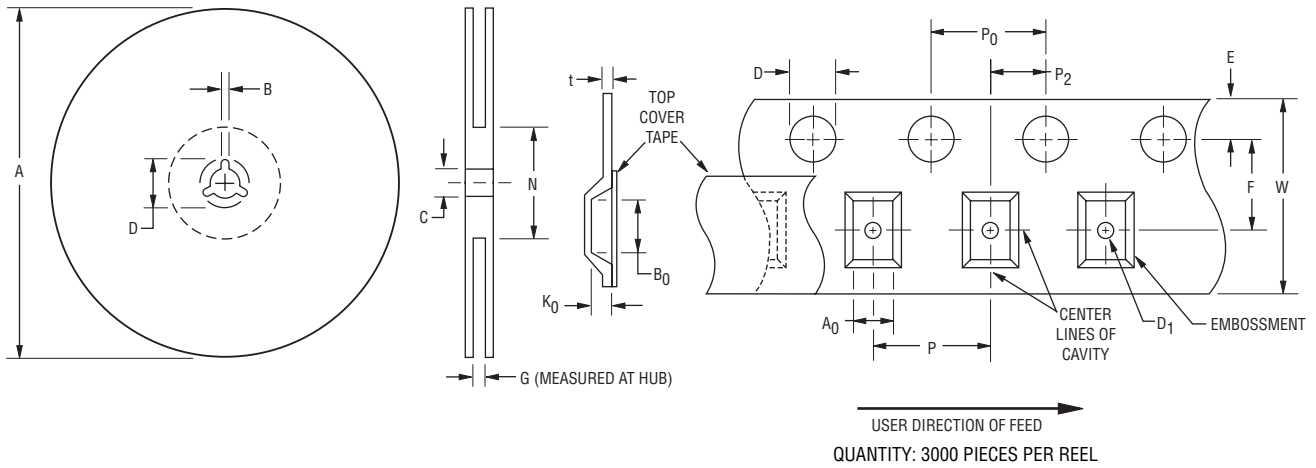

Device	A		B		C		D		G	N
	Min.	Max.	Min.	Max.	Min.	Max.	Min.	Max.	Ref.	Ref.
P40-G240	$\frac{326}{(.12835)}$	$\frac{330.25}{(13.002)}$	1.5 (.059)	2.5 (.098)	12.8 (.504)	13.5 (.531)	20.2 (.795)	-	12.4 (.488)	102 (4.016)

Device	A ₀		B ₀		D		D ₁		E		F	
	Min.	Max.	Min.	Max.	Min.	Max.	Min.	Max.	Min.	Max.	Min.	max.
P40-G240	$\frac{4.2}{(.165)}$	$\frac{4.4}{(.173)}$	$\frac{4.2}{(.165)}$	$\frac{4.4}{(.173)}$	1.5 (.059)	1.6 (.063)	1.5 (.059)	-	1.65 (.065)	1.85 (.073)	5.45 (.216)	5.55 (.219)

Device	K ₀		P		P ₀		P ₂		t		W	
	Min.	Max.	Min.	Max.	Min.	Max.	Min.	Max.	Min.	Max.	Min.	Max.
P40-G240	$\frac{1.05}{(.041)}$	$\frac{1.25}{(.049)}$	$\frac{7.9}{(.311)}$	$\frac{8.1}{(.319)}$	3.9 (.159)	4.1 (.161)	1.9 (.075)	2.1 (.083)	0.25 (.010)	0.35 (.014)	11.7 (.461)	12.3 (.484)

DIMENSIONS: $\frac{\text{MM}}{\text{(INCHES)}}$

Данный компонент на территории Российской Федерации

Вы можете приобрести в компании MosChip.

Для оперативного оформления запроса Вам необходимо перейти по данной ссылке:

<http://moschip.ru/get-element>

Вы можете разместить у нас заказ для любого Вашего проекта, будь то серийное производство или разработка единичного прибора.

В нашем ассортименте представлены ведущие мировые производители активных и пассивных электронных компонентов.

Нашей специализацией является поставка электронной компонентной базы двойного назначения, продукции таких производителей как XILINX, Intel (ex.ALTERA), Vicor, Microchip, Texas Instruments, Analog Devices, Mini-Circuits, Amphenol, Glenair.

Сотрудничество с глобальными дистрибьюторами электронных компонентов, предоставляет возможность заказывать и получать с международных складов практически любой перечень компонентов в оптимальные для Вас сроки.

На всех этапах разработки и производства наши партнеры могут получить квалифицированную поддержку опытных инженеров.

Система менеджмента качества компании отвечает требованиям в соответствии с ГОСТ Р ИСО 9001, ГОСТ РВ 0015-002 и ЭС РД 009

Офис по работе с юридическими лицами:

105318, г.Москва, ул.Щербаковская д.3, офис 1107, 1118, ДЦ «Щербаковский»

Телефон: +7 495 668-12-70 (многоканальный)

Факс: +7 495 668-12-70 (доб.304)

E-mail: info@moschip.ru

Skype отдела продаж:

moschip.ru

moschip.ru_4

moschip.ru_6

moschip.ru_9