

EAO – Your Expert Partner for
Human Machine Interfaces

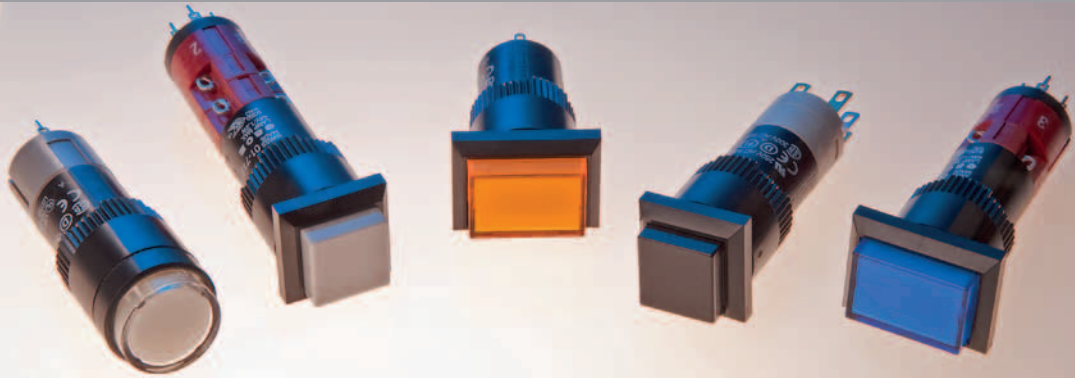

EAO Product Information

Series 01



Description	3
Product Assembly	4
Devices raised mounting	5
Accessories.....	7
Technical Data.....	12
Typical Applications	14
Application guidelines.....	15
Marking	16
Drawings.....	17
Index.....	25

Product Information

General notes

The Series 01 illuminated pushbuttons are equipped with snap-action-, low level switching elements.

The front dimensions of these units are 18 x 18 mm, 18 x 24 mm or 18 mm dia..

In addition to a number of illuminated pushbuttons, the customer can choose from a wide range of other units and accessories having the same front and mounting dimensions.

Mounting

Mount from the front through the mounting hole.

The Universal terminals of the low level switching elements permit them to be mount on printed circuit boards (PCB). These terminals are also suitable for dip soldering. For these terminals we can also supply a plug-in base which, when soldered on to the board, enables the switch to be plugged in.

All rectangular switches are secured against rotation.

Lenses

The flat lenses, made of polymethyl methacrylate (PMMA), are obtainable in various colours, as well as transparent and translucent.

Marking

For further information about engraving, hot stamping and film inserts see part Marking.

Illumination

The T5.5 incandescent (filament) lamp (6...48 V, 1.2 W) ensures perfect illumination of the lenses, which are supplied in various colours.

T5.5 Single-LED (6, 12, 24, 28, 48 V) are also available in blue, green, red, white or yellow.

Luminosity and wave length scattering caused by the technology used in the LED manufacturing processes may lead to visual differences in our products.

For supply voltages above 48 V, it is necessary to use a voltage reduction element (external series resistor or transformer).

Do not solder the indicators and pushbuttons terminals directly, because of the high surface temperature.

Position indication

The status of a maintained action switch can be determined by the position of the lens.

Specimen order

Illuminated pushbutton :

- Illuminated pushbutton actuator, 18 x 24 mm, snap-action switching element, 1NC + 1NO contacts, momentary action, soldering terminal 01-121.0252

Essential accessories :

- Lens plastic blue, transparent, 18 x 24 mm 01-982.6
- Single-LED, T5.5, 24 VAC/DC, white diffuse 10-2112.1069

*We reserve the right to modify technical data
All dimensions in mm*

Pushbutton illuminative, raised mounting





- 1 Lens
- 2 Switch housing
- 3 Fixing nut

Indicator actuator



Essential Accessories:

-  Lens plastic page 7
-  Single-LED page 10

	Front protection	Diode (1N 4007)	Terminals	□ 18 x 18 mm Typ-Nr.	□ 18 x 24 mm Typ-Nr.	∅ 18 mm Typ-Nr.	Component layout	Mounting dimensions	Technical drawing	Circuit drawing	
Indicator actuator	IP 40	1 D	UT	01-703.006	01-701.006	01-741.006	1	1	1	30	0.008
		2 D	UT	01-704.006	01-702.006	01-742.006	1	1	1	31	0.008
		-	S	01-050.005	01-040.005	01-030.005		1	9	1	0.006
			S1	01-050.002	01-040.002	01-030.002		1	9	1	0.006
			UT	01-051.006	01-041.006	01-031.006	1	1	2	1	0.006

Diode (1N 4007): D = Diode, - = without



Terminals: UT = Universal terminal, S = Soldering terminal, S1 = Soldering terminal (also pluggable 2.8 x 0.5 mm)

Component layout from page 17, Mounting dimensions from page 18, Technical drawing from page 18, Circuit drawing from page 20

Illuminated pushbutton actuator



Essential Accessories:

-  Lens plastic page 7
-  Single-LED page 10

	Front protection	Switching system	Contacts	Diode (1N 4007)	Switching action	Terminals	Ø 18 x 18 mm			Ø 18 x 24 mm			Ø 18 mm			Component layout	Mounting dimensions	Technical drawing	Circuit drawing	Eco	
							Typ-Nr.	Typ-Nr.	Typ-Nr.	Typ-Nr.	Typ-Nr.	Typ-Nr.	Typ-Nr.	Typ-Nr.	Typ-Nr.						
Illuminated pushbutton actuator	IP 40	LL	1 NC	-	MA	UT	01-486.036	01-466.036	01-476.036	1	1	2	11	0.009	1	1	2	11	0.009		
					M	UT	01-456.036	01-426.036	01-436.036	1	1	2	25	0.009							
			1 NC + 1 NO	-	MA	UT	01-483.036	01-463.036	01-473.036	1	1	2	14	0.009	1	1	2	14	0.009		
					M	UT	01-453.036	01-423.036	01-433.036	1	1	2	28	0.009							
			1 NO	-	MA	UT	01-485.036	01-465.036	01-475.036	1	1	2	13	0.009	1	1	2	13	0.009		
					M	UT	01-455.036	01-425.036	01-435.036	1	1	2	27	0.009							
			2 NC	-	MA	UT	01-482.036	01-462.036	01-472.036	1	1	2	12	0.009	1	1	2	12	0.009		
					M	UT	01-452.036	01-422.036	01-432.036	1	1	2	26	0.009							
			2 NO	-	MA	UT	01-481.036	01-461.036	01-471.036	1	1	2	15	0.009	1	1	2	15	0.009		
					M	UT	01-451.036	01-421.036	01-431.036	1	1	2	29	0.009							
			SA	1 NC + 1 NO	1 D	MA	H	01-717.0292	01-713.0292	01-747.0292	1	1	10	8	0.010	1	1	10	8	0.010	
						M	H	01-709.0292	01-705.0292	01-743.0292	1	1	10	22	0.010						
		2 D			MA	H	01-718.0292	01-714.0292	01-748.0292	1	1	10	9	0.010	1	1	10	9	0.010		
					M	H	01-710.0292	01-706.0292	01-744.0292	1	1	10	23	0.010							
		-			MA	S	01-281.0252	01-261.0252	01-271.0252		1	8	10	0.008	1	8	10	0.008			
					S1	01-281.022	01-261.022	01-271.022		1	8	7	0.008								
					M	S	01-151.0252	01-121.0252	01-131.0252		1	8	24	0.008							
					S1	01-151.022	01-121.022	01-131.022		1	8	21	0.008								
		2 NC + 2 NO			1 D	MA	H	01-719.0292	01-715.0292	01-749.0292	1	1	10	4	0.012	1	1	10	4	0.012	
						M	H	01-711.0292	01-707.0292	01-745.0292	1	1	10	18	0.012						
		-			2 D	MA	H	01-720.0292	01-716.0292	01-750.0292	1	1	10	5	0.012	1	1	10	5	0.012	
						M	H	01-712.0292	01-708.0292	01-746.0292	1	1	10	19	0.012						
			MA	S	01-282.0252	01-262.0252	01-272.0252		1	8	6	0.010	1	8	20	0.010					
			M	S	01-152.0252	01-122.0252	01-132.0252		1	8	20	0.010									
3 NC + 3 NO	-	MA	S	01-283.0252	01-263.0252	01-273.0252		1	8	3	0.012	1	8	3	0.012						
		M	S	01-153.0252	01-123.0252	01-133.0252		1	8	17	0.012										
4 NC + 4 NO	-	MA	S	01-284.0252	01-264.0252	01-274.0252		1	8	2	0.014	1	8	2	0.014						
		M	S	01-154.0252	01-124.0252	01-134.0252		1	8	16	0.014										

Switch rating: Low level switching element 42 V, 100 mA, snap-action switching element 250 V, 5 A

Switching system: LL = Low level switching element, SA = Snap-action switching element

Contacts: NC = Normally closed, NO = Normally open

Diode (1N 4007): - = without, D = Diode

Switching action: MA = Maintained action, M = Momentary action

Terminals: UT = Universal terminal, H = Combined terminal: Solder-/ Universal (at contact/ at diode), S = Soldering terminal, S1 = Soldering terminal (also pluggable 2.8 x 0.5 mm)

Component layout from page 17, Mounting dimensions from page 18, Technical drawing from page 18, Circuit drawing from page 20

Front

Lens plastic

	Lens	∅ 18 x 18 mm Typ-Nr.	∅ 18 x 24 mm Typ-Nr.	∅ 18 mm Typ-Nr.		
Lens plastic flush, illuminative	blue transparent	01-985.6	01-982.6	01-983.6	0.001	
	colourless transparent	01-985.7	01-982.7	01-983.7	0.001	
	green transparent	01-985.5	01-982.5	01-983.5	0.001	
	orange transparent	01-985.3	01-982.3	01-983.3	0.001	
	red transparent	01-985.2	01-982.2	01-983.2	0.001	
	yellow transparent	01-985.4	01-982.4	01-983.4	0.001	
flush, illuminative (not recommended for film insert)	blue translucent	01-951.6	01-901.6	01-931.6	0.001	
	colourless transparent	01-975.7	01-972.7	01-973.7	0.001	
	green translucent	01-951.5	01-901.5	01-931.5	0.001	
	green transparent	01-975.5	01-972.5	01-973.5	0.001	
	orange translucent	01-951.3	01-901.3	01-931.3	0.001	
	red translucent	01-951.2	01-901.2	01-931.2	0.001	
	red transparent	01-975.2	01-972.2	01-973.2	0.001	
	white translucent	01-951.9	01-901.9	01-931.9	0.001	
	yellow translucent	01-951.4	01-901.4	01-931.4	0.001	
	yellow transparent	01-975.4	01-972.4	01-973.4	0.001	
	flush, non-illuminative	black opaque	01-951.0	01-901.0	01-931.0	0.001
		grey opaque	01-951.8	01-901.8	01-931.8	0.001



Protective cover

	∅ 18 x 18 mm Typ-Nr.	∅ 18 x 24 mm Typ-Nr.	Technical drawing	
Protective cover hinged, transparent, with means for sealing	31-920		7	0.002
		01-925	3	0.002



Technical drawing from page 18

Front protective cap

front protection IP 67

	Front protective cap	∅ 18 x 18 mm Typ-Nr.	∅ 18 x 24 mm Typ-Nr.	Mounting dimensions Technical drawing	
Front protective cap two-part	PVC	31-923		2 6	0.003
	Silikon		31-924.2	2 6	0.003



Mounting dimensions from page 18, Technical drawing from page 18

Protective guard

matt chromium-plated

	Typ-Nr.	Technical drawing	kg
Protective guard broad sides bent upwards narrow ends bent upwards	01-927	5	0.011
	01-926	4	0.011



Technical drawing from page 18

Blind plug

	Blind plug	18 x 18 mm Typ-Nr.	18 x 24 mm Typ-Nr.	Ø 18 mm Typ-Nr.	Mounting dimensions	kg
Blind plug	Plastic black	01-948.0	01-947.0	01-949.0	1	0.001



Mounting dimensions from page 18

Backside

PCB plug-in base

	Terminals	Typ-Nr.	Component layout	kg
PCB plug-in base 16.4 mm dia. x 9.8 mm for Low level switching element, Pins axial	P	31-940	3	0.002
17.8 x 12.9 mm x 9.8 mm for Snap-action switching element 2.8 mm, Pins axial	P	31-942	4	0.002
17.9 x 17.9 x 8.4 mm for Low level switching element, Pins bent at right-angle	P	31-941	2	0.004



PCB plug-in base Pins right-angle : With the extendable mounting the distance between plug-in base and PCB can be varied up to 3 mm.

Terminals: P = PCB terminal

Component layout from page 17

Flat receptacle

	Typ-Nr.	kg
Flat receptacle 2.0 x 0.5 mm for Universal terminal	31-945	0.001
2.8 x 0.5 mm for Plug-in terminal	31-946	0.001



Insulation sleeve

	Typ-Nr.	
Insulation sleeve Cover Plug-in terminals for snap-action switching element 2.8 mm	01-928	0.001
for Flat receptacle 31-945	31-928	0.001
for Flat receptacle 31-946	31-929	0.001



Terminal cover

for snap-action switching element

	Typ-Nr.	
Terminal cover	01-929	0.010



Illumination

Filament lamp

	Socket	Operating voltage/-current	Typ-Nr.	
Filament lamp	T5.5	12 VAC/DC, 100 mA	10-1109.1329	0.001
		12 VAC/DC, 50 mA	10-1109.1279	0.001
		24 VAC/DC, 25 mA	10-1112.1199	0.001
		24 VAC/DC, 50 mA	10-1112.1279	0.001
		28 VAC/DC, 40 mA	10-1113.1249	0.001
		30 VAC/DC, 40 mA	10-1114.1249	0.001
		36 VAC/DC, 35 mA	10-1116.1229	0.001
		48 VAC/DC, 25 mA	10-1119.1199	0.001
		6 VAC/DC, 200 mA	10-1106.1369	0.001



Single-LED

Socket	Light colour	Operating voltage/-current	Typ-Nr.	
T5.5	blue	12 VAC/DC, 7/14 mA	10-2109.1066	0.001
		24 VAC/DC, 7/14 mA	10-2112.1066	0.001
		28 VAC/DC, 7/14 mA	10-2113.1066	0.001
		48 VAC/DC, 4/8 mA	10-2119.1046	0.001
		6 VDC, 15 mA	10-2106.3146	0.001
	green	12 VAC/DC, 4/7 mA	10-2109.1065	0.001
		24 VAC/DC, 4/7 mA	10-2112.1065	0.001
		28 VAC/DC, 4/7 mA	10-2113.1065	0.001
		48 VAC/DC, 2/4 mA	10-2119.1045	0.001
		6 VDC, 7 mA	10-2106.3145	0.001
	red	12 VAC/DC, 7/14 mA	10-2109.1062	0.001
		24 VAC/DC, 7/14 mA	10-2112.1062	0.001
		28 VAC/DC, 7/14 mA	10-2113.1062	0.001
		48 VAC/DC, 4/8 mA	10-2119.1042	0.001
		6 VDC, 15 mA	10-2106.3142	0.001
	white diffuse	12 VAC/DC, 7/14 mA	10-2109.1069	0.001
		24 VAC/DC, 7/14 mA	10-2112.1069	0.001
		28 VAC/DC, 7/14 mA	10-2113.1069	0.001
		48 VAC/DC, 4/8 mA	10-2119.1049	0.001
		6 VDC, 15 mA	10-2106.3149	0.001
	yellow	12 VAC/DC, 7/14 mA	10-2109.1064	0.001
		24 VAC/DC, 7/14 mA	10-2112.1064	0.001
		28 VAC/DC, 7/14 mA	10-2113.1064	0.001
		48 VAC/DC, 4/8 mA	10-2119.1044	0.001
6 VDC, 15 mA		10-2106.3144	0.001	



Note:
AC operation through half-wave rectifier possible, slight flickering can occur.

Series resistor

for lamp voltage reduction

	Operating voltage	Typ-Nr.	
Series resistor 10 kΩ, for filament lamp 48 VAC, 25 mA	230/240 V	02-904.7	0.003
2.7 kΩ, for filament lamp 48 VAC, 25 mA	110 V	02-904.0	0.003
3.3 kΩ, for filament lamp 48 VAC, 25 mA	125 V	02-904.1	0.003
4.7 kΩ, for filament lamp 48 VAC, 25 mA	145 V	02-904.3	0.003



Please keep to the country specific security rules.

Terminal plate empty

for fitting with series resistors

	Typ-Nr.	
Terminal plate empty 10 spaces 125 x 60 x 15 mm	02-912.2	0.045
15 spaces 187.5 x 60 x 15 mm	02-912.3	0.090
5 spaces 62.5 x 60 x 15 mm	02-912.1	0.025



Assembling

Lens remover

	Typ-Nr.	
Lens remover	02-905	0.011



Lamp remover

	Typ-Nr.	
Lamp remover	02-906	0.002



CAUTION

A switching process might be released when replacing the Lamp/LED !

Mounting tool

for tightening or loosening of the fixing nut

	Typ-Nr.	
Mounting tool	01-907	0.020



Dressing tool

for aligning buttons

	Typ-Nr.	
Dressing tool	01-906	0.030



Actuator with snap-action switching element

Switching system

Self-cleaning, double-break, snap action switching system (with contact gap 2 x 0.5 mm).
 1 Normally closed or 1 Normally open contact per element.
 Snap-action switching elements with soldering terminals at the sides: Up to 4 switching element can be on a pushbutton (max. 4 Normally closed and 4 Normally open contacts).
 Snap-action switching element with axial plug-in terminals 2.8 mm stachable, only 1 switching element can be on a pushbutton.

Material

Material of contact

Gold plated silver

Switch housing

Axial plug-in/soldering terminal 2.8 mm:
 Diallylphthalate (DAP), Polyamide (PA66), Polysulfone (PSU), heat-resistant and self-extinguishing
 Soldering terminal: Ultramide (PA 6.6)

Actuator housing

Polyphenylene (PPO), self-extinguishing

Mechanical characteristics

Terminals

Snap-action switching element with tinned soldering terminals at the sides:
 Max. wire diameter 2 wires à 1.2 mm
 Max. wire cross-section of stranded cable 1 x 1 mm²
 Snap-action switching element with axial plug-in terminals, which can also be used as soldering terminals: Plug-in terminal 2.8 x 0.5 mm

Soldering terminal:

Max. wire diameter 2 wire of 1 mm²
 Max. wire cross-section of stranded cable 2 x 0.75 mm² or 1 x 1 mm²

Actuating force

2 N ... 5.5 N, depending on the number of switching elements

Actuating travel

3 mm

Rebound time

≤5ms

Mechanical lifetime

Momentary action 2 million cycles of operation
 Maintained action 1 million cycles of operation

Electrical characteristics

Standards

IEC 61058, EN 61058

Rated voltage

250 VAC/VDC

Rated current

5 A

Contact resistance

Starting value (initial) ≤50 mΩ

Conventional free air thermal current

5 A

The maximum current in continuous operation and at ambient temperature not exceeding the quoted maximum values.

Switch rating

250 VAC, 5 A (cosφ 1)
 250 VAC, 3 A (cosφ 0,3)

Switch rating AC (cosφ 0,7)

Voltage	125 VAC	250 VAC
Current	3 A	2 A

Switch rating DC (inductive) L:R = 30 ms

Voltage	24 VDC	60 VDC	110 VDC	220 VDC
Current	2 A	0.7 A	0.2 A	0.1 A

Electric strength

2500 VAC, 50 Hz, 1 min. between all terminals and earth, as per IEC 60512-2-11

Protection class

II

Environmental conditions

Storage temperature

-40 °C ... +85 °C

Service temperature

-25 °C ... +55 °C

For indicators and illuminated pushbuttons mounted as a block, make sure the heat can escape freely.

Protection degree

Front P 40
 IP 67 with front protective cap

Shock resistance

(Single impacts, semi-sinusoidal)
 15 g for 11 ms, as per IEC 60512-4-3, IEC 60068-2-27

Vibration resistance

(sinusoidal)
 10 g at 0-2000 Hz, amplitude 1.5 mm, as per IEC 60512-4-4, IEC 60068-2-6

Climate resistance

Standard condition, as per IEC 60068-2-3 and 2-30
 Changing condition, as per IEC 60068-2-14 and 2-33

Approvals

Approbations

CB (IEC 61058)
 CSA
 ENEC (EN 61058)
 Germanischer Lloyd
 UL

Declaration of conformity

CE

Actuator with low level switching element

Switching system

This low level switching element was designed for switching low powers in electronic circuits. The mechanism assures reliable switching of loads ranging from a few μA / μV up to 100 mA / 42 VAC/DC.

Single-break momentary contact, as normally open or normally closed with 4 independent points of contact. 2 momentary contacts per switching element; combination of normally open and normally closed is possible.

Special features are the long life, extremely short rebound time and stable contact resistance.

Material

Material of contact

Gold plated

Switch housing

Polysulfone (PSU), heat-resistant and self-extinguishing

Actuator housing

Polyphenylene (PPO), self-extinguishing

Mechanical characteristics

Terminals

The universal terminals permit these units to be mounted on printed circuit boards (PCB). These terminals can also be used as soldering or plug-in terminals.

For these terminals we can also supply a plug-in base which, when soldered on to the board, enables the switch to be plugged in.

Soldering terminal:

Max. wire diameter 2 wires à 0.8 mm

Max. wire cross-section of stranded cable 1x 0.75 mm²

Plug-in terminal: 2.0 x 0.5 mm

Actuating force

3 N ... 3,5 N

Actuating travel

3 mm

Rebound time

Typ. <100 μs

Mechanical lifetime

Momentary action 5 million cycles of operation

Maintained action 1 million cycles of operation

Electrical characteristics

Standards

EN 61058

Contact resistance

Starting value (initial) $\leq 50 \text{ m}\Omega$

Switch rating

10 μA , 100 μV to 100 mA at 42 VAC/VDC

Electric strength

2500 VAC, 50 Hz, 1 min. between all terminals and earth, as per IEC 60512-2-11

Protection class

II

Environmental conditions

Storage temperature

-40 °C ... +85 °C

Service temperature

-25 °C ... +55 °C

For indicators and illuminated pushbuttons mounted as a block, make sure the heat can escape freely.

Protection degree

Front P 40

IP 67 with front protective cap

Shock resistance

(Single impacts, semi-sinusoidal)

15 g for 11 ms, as per IEC 60512-4-3, IEC 60068-2-27

Climate resistance

Standard condition, as per IEC 60068-2-3 and 2-30

Changing condition, as per IEC 60068-2-14 and 2-33

Diode element

When indicators and illuminated pushbuttons equipped with diodes, the user is able to perform a lamp check or wire an alarm circuit simply with a considerable saving of space.

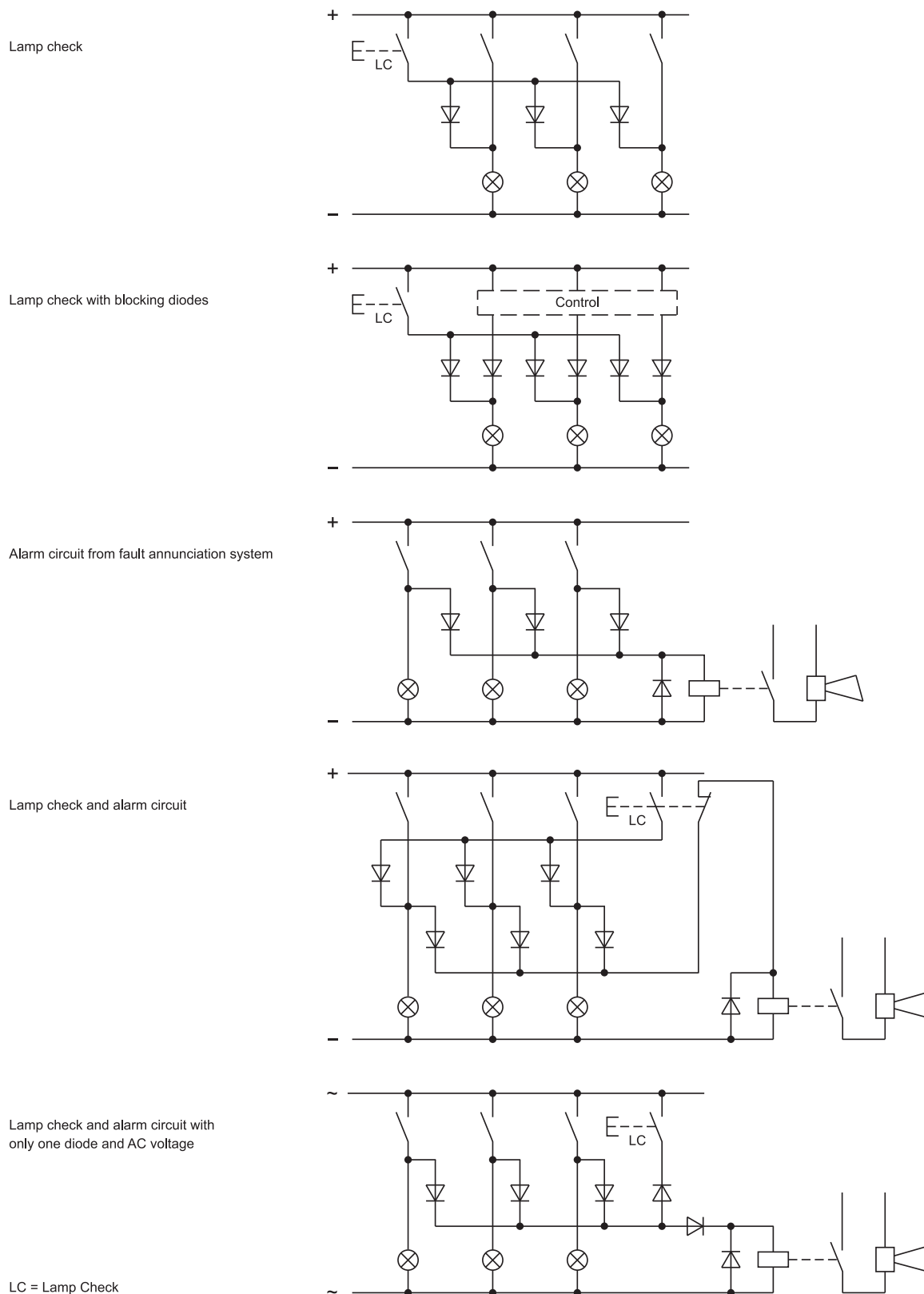

LC = Lamp Check

Suppressor circuits

When switching inductive loads such as relays, DC motors, and DC solenoids, it is always important to absorb surges (e.g. with a diode) to protect the contacts. When these inductive loads are switched off, a counter emf can severely damage switch contacts and greatly shorten lifetime.

Fig. 1 shows an inductive load with a free-wheeling diode connected in parallel. This free-wheeling diode provides a path for the inductor current to flow when the current is interrupted by the switch. Without this free-wheeling diode, the voltage across the coil will be limited only by dielectric breakdown voltages of the circuit or parasitic elements of the coil. This voltage can be kilovolts in amplitude even when nominal circuit voltages are low (e.g. 12 VDC) see Fig. 2.

The free-wheeling diode should be chosen so that the reverse breakdown voltage is greater than the voltage driving the inductive load. The DC blocking voltage (V_R) of the free-wheeling diode can be found in the datasheet of a diode. The forward current should be equal or greater than the maximum current flowing through the load.

To get an efficient protection, the free-wheeling diode must be connected as close as possible to the inductive load!

Switching with inductive load
Fig. 1

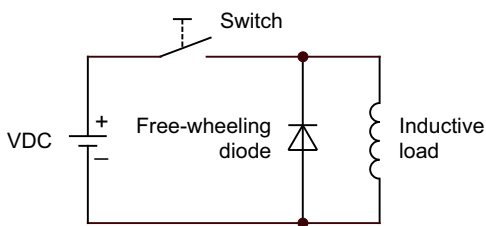

Counter emf
over load without free-wheeling diode
Fig. 2

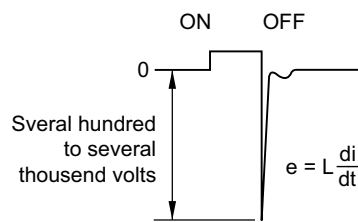

General notes

1. Engraving

In addition to the most commonly used world languages, in DIN 1451-3 close spacing, other typefaces are available as Scandinavian, Slavic, Greek, Russian and Polish.

Red, blue and black lenses are filled with white colour. Other colour lenses are filled in black. Standard height of letters is 2 mm. If the height is not specified, we will supply 2 mm engraved letters.

2. Hot stamping

For larger series it is worth considering markings by means of hot stamping. We will be pleased to advise you.

For letters and figures, typefaces with 2.5 mm, 3 mm and 4 mm are available.

3. Film inserts

Instead of using engraving the lenses can be fitted with transparent film inserts, as an alternative. For this purpose, though, it is advisable to use transparent lenses.

In the case of use of a smoke-black lens the fitted film becomes readable only if the lamp is on.

To insert the film, the feet of the lens holder have to be pushed together far enough to enable the lens to be lifted off easily.

The film thickness is 0.2 mm.

Important : Consider pushbutton mounting orientation before specifying engraving characters !

All dimensions in mm

Front size (Lens)	Film insert max. size	Height of letters h	Number of lines	Number of (target value) capital letters per line	Number of (target value) small letters per line	Image
18 dia. (15.8 dia.)	12.8 dia.	2.5	3	6	6	B4
		3.0	2	5	6	B4
		4.0	2	3	4	B4
		5.0	1	2	3	B4
		6.0	1	2	2	B4
		8.0	1	2	2	B4
18 x 18 (12.8 x 12.8)	10.2 x 10.2	2.5	3	6 - 7	7	B3
		3.0	2	5 - 6	6	B3
		4.0	2	4	4	B3
		5.0	1	3	3 - 4	B3
		6.0	1	2 - 3	3	B3
		8.0	1	2	2	B3
18 x 24 (12.8 x 18.8)	10.2 x 16.2	2.5	3	10	10 - 11	B1
			4	6 - 7	7	B2
		3.0	2	8 - 9	9	B1
			4	5 - 6	6	B2
		4.0	2	6	6 - 7	B1
			3	4	4	B2
		5.0	1	5	5 - 6	B1
			2	3	3 - 4	B2
		6.0	1	4	4 - 5	B1
				2 - 3	3	B2
		8.0	1	3	3 - 4	B1
				2	2	B2

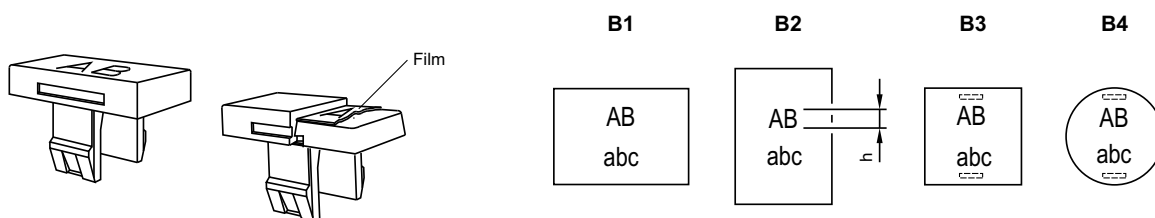

Component layout

1 Indicator actuator page 5 | Illuminated pushbutton actuator page 6

Terminals (rearside)

PCB layout (conductor side)

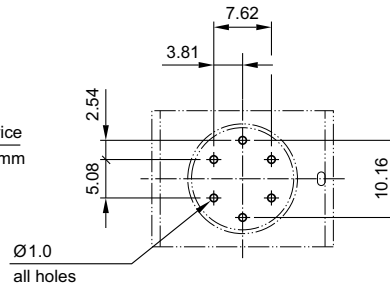
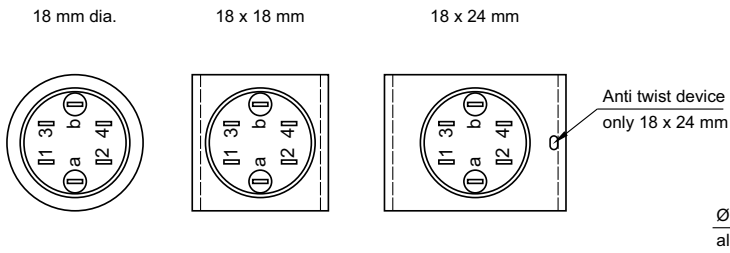

2 PCB plug-in base page 8

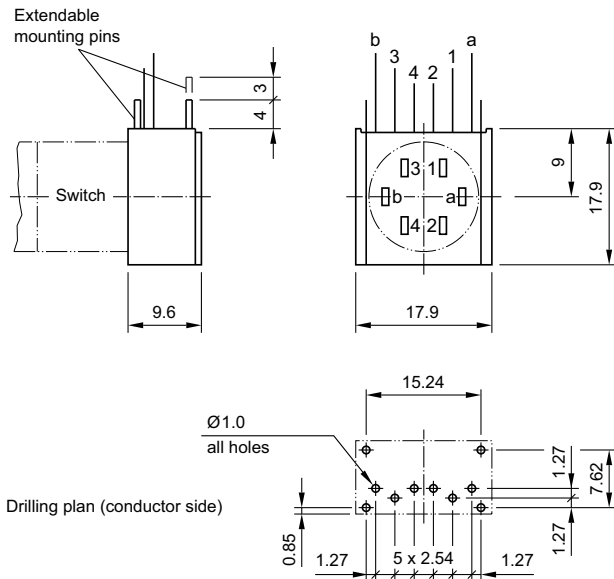

3 PCB plug-in base page 8

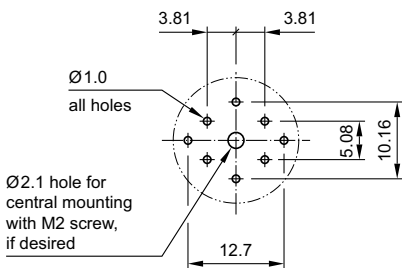

4 PCB plug-in base page 8

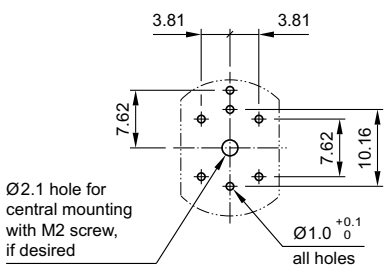

Mounting dimensions

1 Indicator actuator page 5 | Illuminated pushbutton actuator page 6 | Blind plug page 8

18 x 18 mm

18 x 24 mm

Ø18 mm

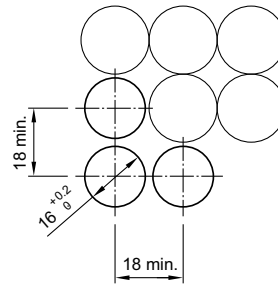
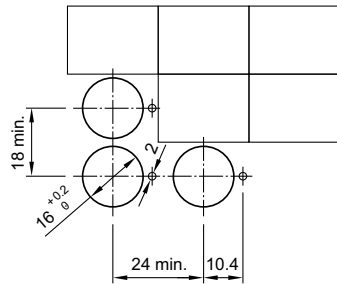
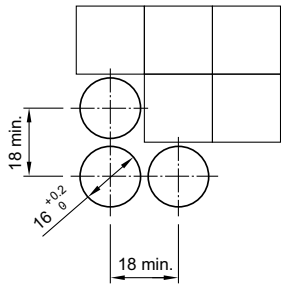

2 Front protective cap page 7

18 x 18 mm

18 x 24 mm

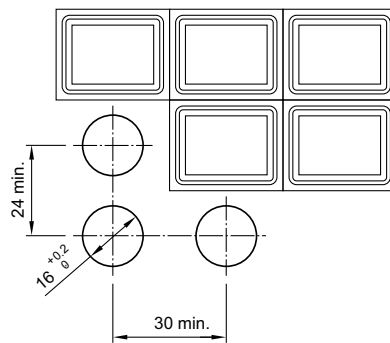
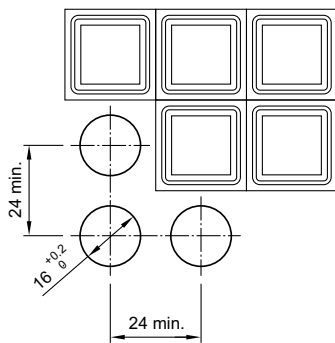

Technical drawing

1 Indicator actuator page 5

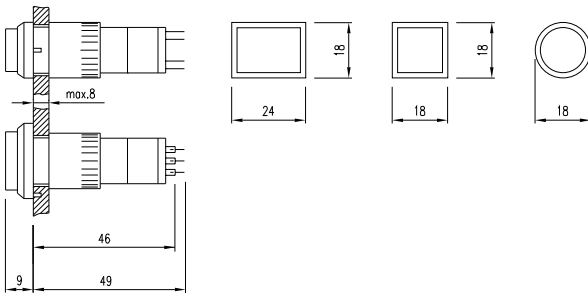

2 Indicator actuator page 5 | Illuminated pushbutton actuator page 6

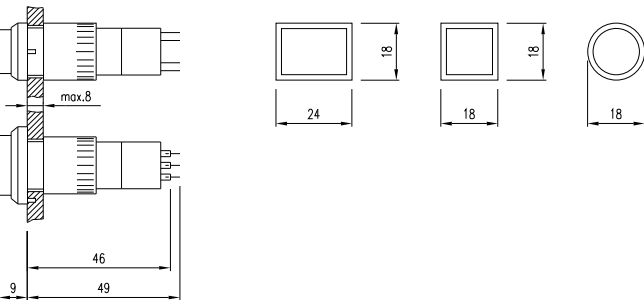

3 Protective cover page 7

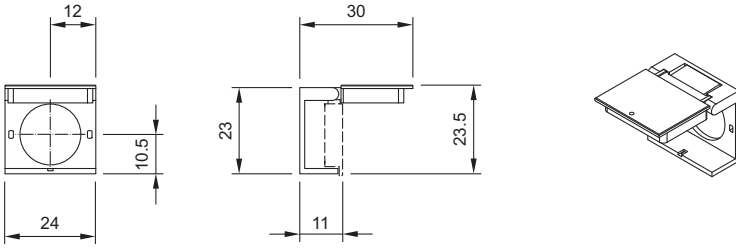

4 Protective guard page 8

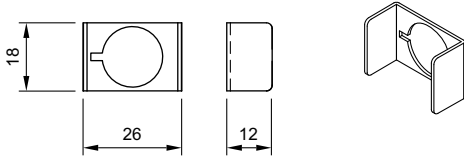

5 Protective guard page 8

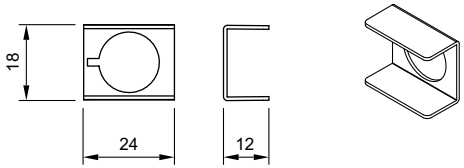

6 Front protective cap page 7

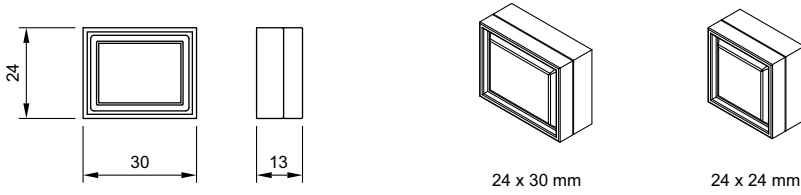

7 Protective cover page 7

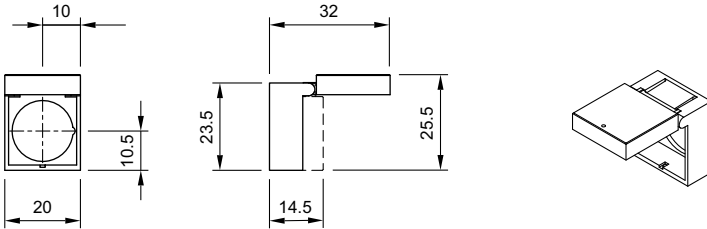

8 Illuminated pushbutton actuator page 6

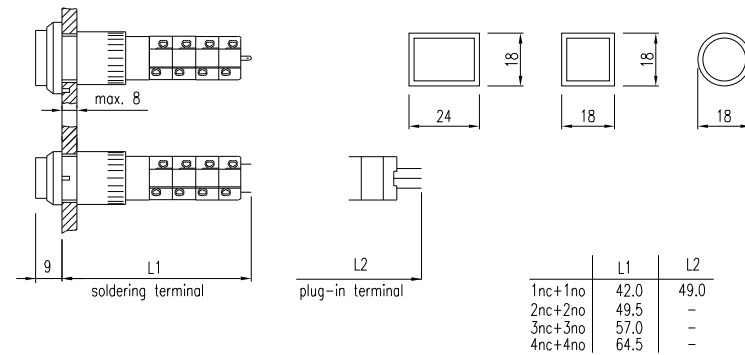

9 Indicator actuator page 5

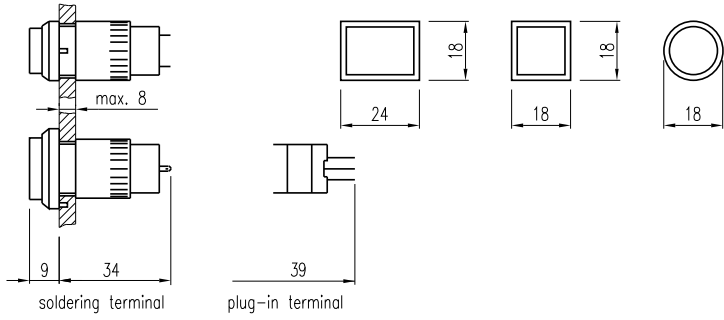

10 Illuminated pushbutton actuator page 6

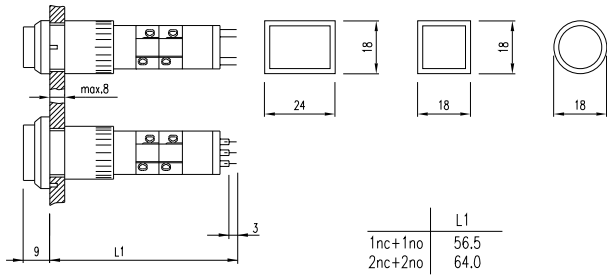

Circuit drawing

1 Indicator actuator page 5

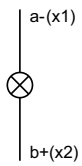

2 Illuminated pushbutton actuator page 6

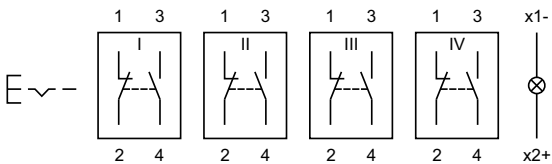

3 Illuminated pushbutton actuator page 6

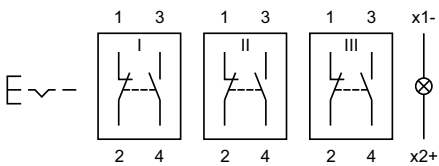

4 Illuminated pushbutton actuator page 6

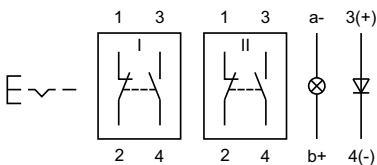

5 Illuminated pushbutton actuator page 6

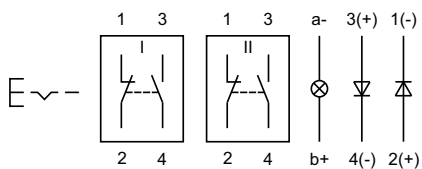

6 Illuminated pushbutton actuator page 6

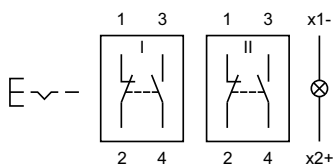

7 Illuminated pushbutton actuator page 6

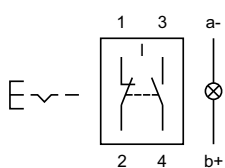

8 Illuminated pushbutton actuator page 6

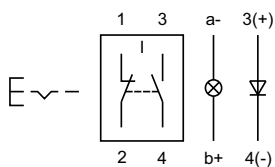

9 Illuminated pushbutton actuator page 6

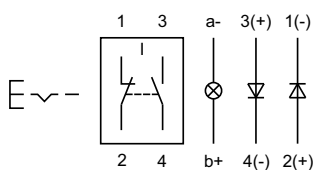

10 Illuminated pushbutton actuator page 6

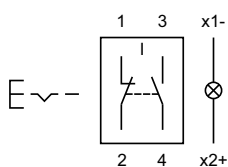

11 Illuminated pushbutton actuator page 6

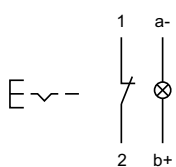

12 Illuminated pushbutton actuator page 6

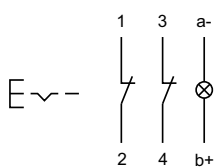

13 Illuminated pushbutton actuator page 6

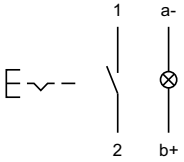

14 Illuminated pushbutton actuator page 6

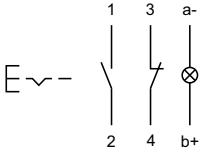

15 Illuminated pushbutton actuator page 6

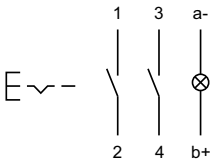

16 Illuminated pushbutton actuator page 6

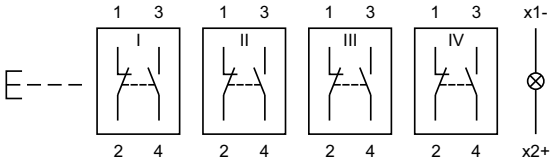

17 Illuminated pushbutton actuator page 6

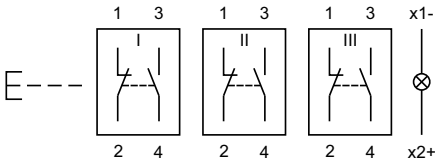

18 Illuminated pushbutton actuator page 6

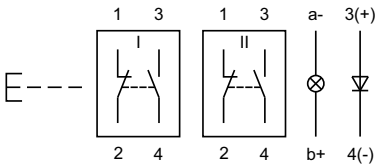

19 Illuminated pushbutton actuator page 6

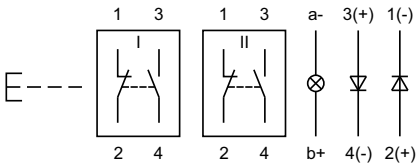

20 Illuminated pushbutton actuator page 6

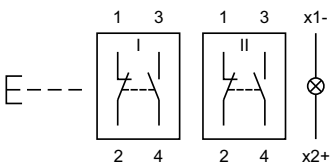

21 Illuminated pushbutton actuator page 6

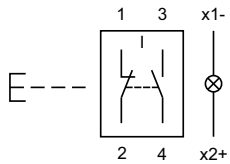

22 Illuminated pushbutton actuator page 6

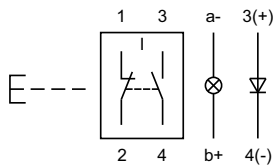

23 Illuminated pushbutton actuator page 6

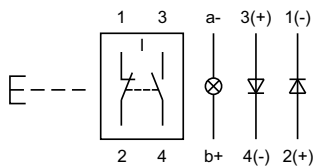

24 Illuminated pushbutton actuator page 6

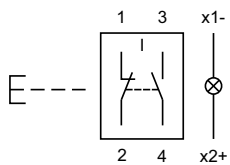

25 Illuminated pushbutton actuator page 6

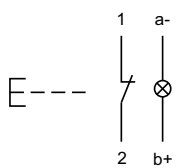

26 Illuminated pushbutton actuator page 6

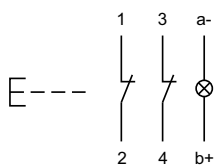

27 Illuminated pushbutton actuator page 6

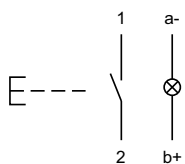

28 Illuminated pushbutton actuator page 6

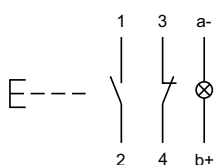

29 Illuminated pushbutton actuator page 6

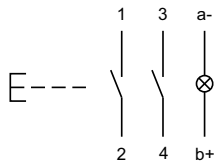

30 Indicator actuator page 5

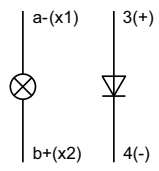

31 Indicator actuator page 5

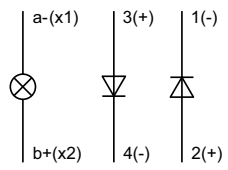

Index from Typ-Nr.

Typ-Nr.	Page	Typ-Nr.	Page	Typ-Nr.	Page
01-030.002	5	01-476.036	6	01-951.2	7
01-030.005	5	01-481.036	6	01-951.3	7
01-031.006	5	01-482.036	6	01-951.4	7
01-040.002	5	01-483.036	6	01-951.5	7
01-040.005	5	01-485.036	6	01-951.6	7
01-041.006	5	01-486.036	6	01-951.8	7
01-050.002	5	01-701.006	5	01-951.9	7
01-050.005	5	01-702.006	5	01-972.2	7
01-051.006	5	01-703.006	5	01-972.4	7
01-121.022	6	01-704.006	5	01-972.5	7
01-121.0252	6	01-705.0292	6	01-972.7	7
01-122.0252	6	01-706.0292	6	01-973.2	7
01-123.0252	6	01-707.0292	6	01-973.4	7
01-124.0252	6	01-708.0292	6	01-973.5	7
01-131.022	6	01-709.0292	6	01-973.7	7
01-131.0252	6	01-710.0292	6	01-975.2	7
01-132.0252	6	01-711.0292	6	01-975.4	7
01-133.0252	6	01-712.0292	6	01-975.5	7
01-134.0252	6	01-713.0292	6	01-975.7	7
01-151.022	6	01-714.0292	6	01-982.2	7
01-151.0252	6	01-715.0292	6	01-982.3	7
01-152.0252	6	01-716.0292	6	01-982.4	7
01-153.0252	6	01-717.0292	6	01-982.5	7
01-154.0252	6	01-718.0292	6	01-982.6	7
01-261.022	6	01-719.0292	6	01-982.7	7
01-261.0252	6	01-720.0292	6	01-983.2	7
01-262.0252	6	01-741.006	5	01-983.3	7
01-263.0252	6	01-742.006	5	01-983.4	7
01-264.0252	6	01-743.0292	6	01-983.5	7
01-271.022	6	01-744.0292	6	01-983.6	7
01-271.0252	6	01-745.0292	6	01-983.7	7
01-272.0252	6	01-746.0292	6	01-985.2	7
01-273.0252	6	01-747.0292	6	01-985.3	7
01-274.0252	6	01-748.0292	6	01-985.4	7
01-281.022	6	01-749.0292	6	01-985.5	7
01-281.0252	6	01-750.0292	6	01-985.6	7
01-282.0252	6	01-901.0	7	01-985.7	7
01-283.0252	6	01-901.2	7	02-904.0	10
01-284.0252	6	01-901.3	7	02-904.1	10
01-421.036	6	01-901.4	7	02-904.3	10
01-422.036	6	01-901.5	7	02-904.7	10
01-423.036	6	01-901.6	7	02-905	11
01-425.036	6	01-901.8	7	02-906	11
01-426.036	6	01-901.9	7	02-912.1	10
01-431.036	6	01-906	11	02-912.2	10
01-432.036	6	01-907	11	02-912.3	10
01-433.036	6	01-925	7	10-1106.1369	9
01-435.036	6	01-926	8	10-1109.1279	9
01-436.036	6	01-927	8	10-1109.1329	9
01-451.036	6	01-928	9	10-1112.1199	9
01-452.036	6	01-929	9	10-1112.1279	9
01-453.036	6	01-931.0	7	10-1113.1249	9
01-455.036	6	01-931.2	7	10-1114.1249	9
01-456.036	6	01-931.3	7	10-1116.1229	9
01-461.036	6	01-931.4	7	10-1119.1199	9
01-462.036	6	01-931.5	7	10-2106.3142	10
01-463.036	6	01-931.6	7	10-2106.3144	10
01-465.036	6	01-931.8	7	10-2106.3145	10
01-466.036	6	01-931.9	7	10-2106.3146	10
01-471.036	6	01-947.0	8	10-2106.3149	10
01-472.036	6	01-948.0	8	10-2109.1062	10
01-473.036	6	01-949.0	8	10-2109.1064	10
01-475.036	6	01-951.0	7	10-2109.1065	10

Index from Typ-Nr.

Typ-Nr.	Page	Typ-Nr.	Page	Typ-Nr.	Page
10-2109.1066	10				
10-2109.1069	10				
10-2112.1062	10				
10-2112.1064	10				
10-2112.1065	10				
10-2112.1066	10				
10-2112.1069	10				
10-2113.1062	10				
10-2113.1064	10				
10-2113.1065	10				
10-2113.1066	10				
10-2113.1069	10				
10-2119.1042	10				
10-2119.1044	10				
10-2119.1045	10				
10-2119.1046	10				
10-2119.1049	10				
31-920	7				
31-923	7				
31-924.2	7				
31-928	9				
31-929	9				
31-940	8				
31-941	8				
31-942	8				
31-945	8				
31-946	8				

	EAO AG
	Tannwaldstrasse 88 4601 Olten, Switzerland
E-mail	info@eao.com
Website	www.eao.com
	Austria
Phone	+49 201 85 87 0
Fax	+49 201 85 87 210
E-mail	sales.ede@eao.com
	Belgium
Phone	+32 3 777 82 36
Fax	+32 3 777 84 19
E-mail	sales.ebl@eao.com
	China
Phone	+852 27 86 91 41
Fax	+852 27 86 95 61
E-mail	sales.ehk@eao.com
	France
Phone	+33 1 64 43 37 37
Fax	+33 1 64 43 37 49
E-mail	sales.esa@eao.com
	Germany
Phone	+49 201 85 87 0
Fax	+49 201 85 87 210
E-mail	sales.ede@eao.com
	Italy
Phone	+39 035 481 0189
Fax	+39 035 481 3786
E-mail	sales.eit@eao.com
	Japan
Phone	+81 3 5444 5411
Fax	+81 3 5444 0345
E-mail	sales.esj@eao.com
	Netherlands
Phone	+31 78 653 17 00
Fax	+31 78 653 17 99
E-mail	sales.enl@eao.com
	Sweden
Phone	+46 8 683 86 60
Fax	+46 8 724 29 12
E-mail	sales.esw@eao.com
	Switzerland
Phone	+41 62 388 95 00
Fax	+41 62 388 95 55
E-mail	sales.ech@eao.com
	United Kingdom
Phone	+44 1444 236 000
Fax	+44 1444 236 641
E-mail	sales.euk@eao.com
	USA
Phone	+1 203 877 4577
Fax	+1 203 877 3694
E-mail	sales.eus@eao.com
	Other Countries
Phone	+41 62 286 92 10
Fax	+41 62 296 21 62
E-mail	info@eao.com

Данный компонент на территории Российской Федерации

Вы можете приобрести в компании MosChip.

Для оперативного оформления запроса Вам необходимо перейти по данной ссылке:

<http://moschip.ru/get-element>

Вы можете разместить у нас заказ для любого Вашего проекта, будь то серийное производство или разработка единичного прибора.

В нашем ассортименте представлены ведущие мировые производители активных и пассивных электронных компонентов.

Нашей специализацией является поставка электронной компонентной базы двойного назначения, продукции таких производителей как XILINX, Intel (ex.ALTERA), Vicor, Microchip, Texas Instruments, Analog Devices, Mini-Circuits, Amphenol, Glenair.

Сотрудничество с глобальными дистрибьюторами электронных компонентов, предоставляет возможность заказывать и получать с международных складов практически любой перечень компонентов в оптимальные для Вас сроки.

На всех этапах разработки и производства наши партнеры могут получить квалифицированную поддержку опытных инженеров.

Система менеджмента качества компании отвечает требованиям в соответствии с ГОСТ Р ИСО 9001, ГОСТ РВ 0015-002 и ЭС РД 009

Офис по работе с юридическими лицами:

105318, г.Москва, ул.Щербаковская д.3, офис 1107, 1118, ДЦ «Щербаковский»

Телефон: +7 495 668-12-70 (многоканальный)

Факс: +7 495 668-12-70 (доб.304)

E-mail: info@moschip.ru

Skype отдела продаж:

moschip.ru

moschip.ru_4

moschip.ru_6

moschip.ru_9