

DATA SHEET
SE5512L: Dual-Band 802.11a/b/g/n Wireless LAN Front-End
Preliminary Information

Applications

- IEEE802.11b DSSS WLAN
- IEEE802.11g OFDM WLAN
- IEEE802.11a OFDM WLAN
- IEEE802.11n WLAN
- Access Points, PCMCIA, PC cards

Features

- All RF ports matched to 50 Ω
- Integrated 2.4 GHz PA, 5 GHz PA, T/R switch, 2.5GHz LNA, 5GHz LNA
- Integrated Power Detector for each TX Chain
- 19 dBm O/P Power, 802.11b, 11 Mbits, ACPR = 35 dBc
- 18 dBm @ 3.0 % EVM, 802.11g, 54 Mbits
- 16 dBm @ 3.0 % EVM, 802.11a, 54 Mbits
- Single supply voltage: 3.3 V \pm 10 %
- Lead free, Halogen free, RoHS compliant, MSL 1
- 4mm x 4mm x 0.9mm, QFN Package

Ordering Information

Part No.	Package	Remark
SE5512L	24 pin QFN	Samples
SE5512L-R	24 pin QFN	Tape and Reel
SE5512L-EK1	N/A	Evaluation kit

Product Description

The SE5512L is a complete 802.11a/b/g/n WLAN RF front-end module providing all the functionality of the power amplifiers, filtering, power detector, T/R switch, diplexers, LNA and associated matching. The SE5512L provides a complete 2.4 GHz and 5 GHz WLAN RF solution from the output of the transceiver to the antenna in an ultra compact form factor.

Designed for ease of use, all RF ports are matched to 50 Ω to simplify PCB layout and the interface to the transceiver RFIC. The SE5512L also includes a transmit power detector with 20 dB of dynamic range for each transmit chain. Each transmit chain has a separate digital enable control for transmitter power ramp on/off control. The power ramp rise/fall time is less than 0.7 μ sec.

The device also provides a notch filter from 3.260-3.267 GHz and 3.28-3.89 GHz prior to the input of each 2.4 GHz and 5 GHz power amplifiers, respectively.

The SE5512L packaged in 4mm x 4mm x 0.9mm, Halogen free, Lead free, ROHS compliant, MSL 3 QFN package.

DATA SHEET
SE5512L: Dual-Band 802.11a/b/g/n Wireless LAN Front-End
Preliminary Information

Functional Block Diagram

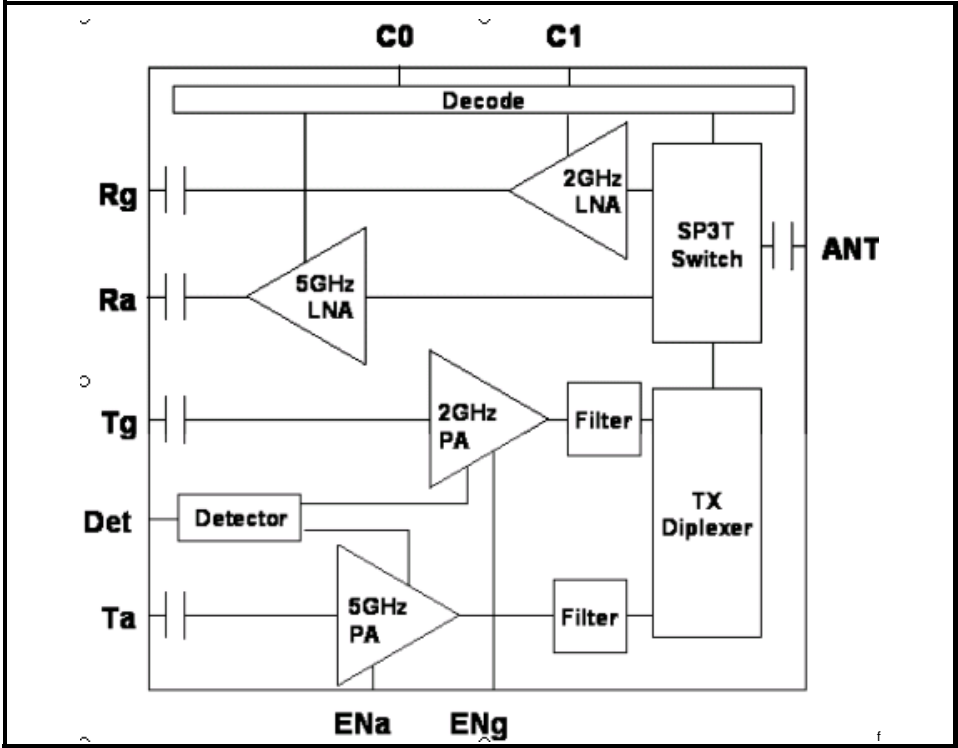

Figure 1: SE5512L Functional Block Diagram

DATA SHEET
SE5512L: Dual-Band 802.11a/b/g/n Wireless LAN Front-End
Preliminary Information

Pin Out Diagram

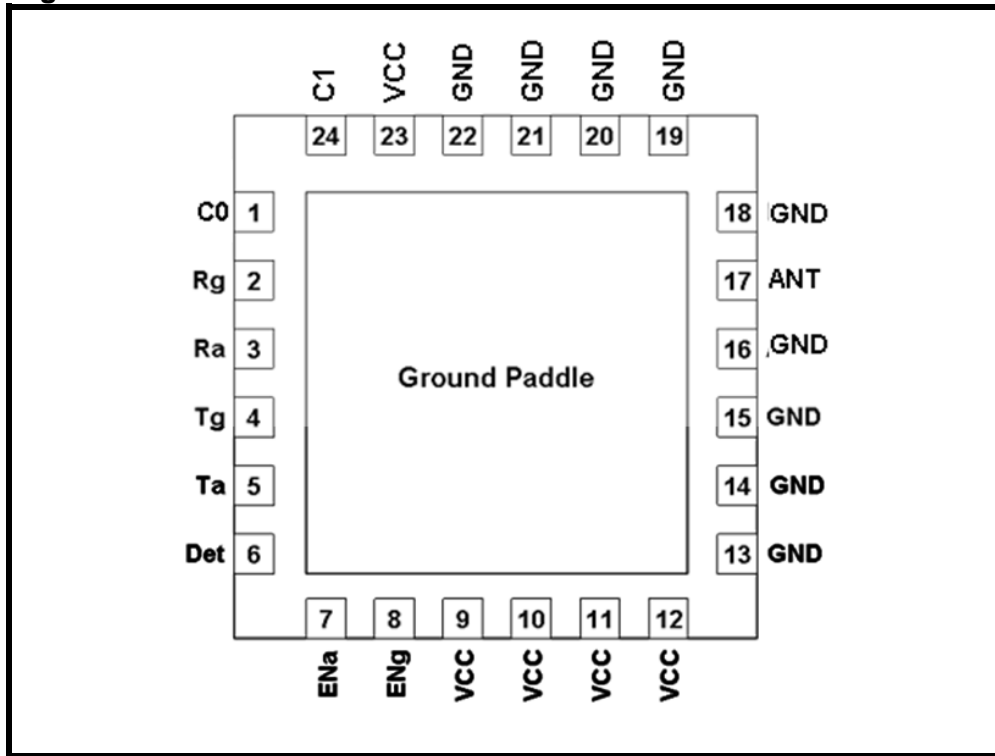

Figure 2: SE5512L Pin Out (Top View Through Package)

Pin Out Description

Pin No.	Name	Description
1	C0	Switch Control
2	Rg	2.4 GHz RF Receive Output
3	Ra	5 GHz RF Receive Output
4	Tg	2.4 GHz RF Transmit Input
5	Ta	5 GHz RF Transmit Input
6	Det	2.4/5 GHz Power Detector Output
7	ENa	5 GHz Power Amplifier Enable
8	ENg	2.4 GHz Power Amplifier Enable
9	VCC	Supply Voltage
10	VCC	Supply Voltage
11	VCC	Supply Voltage
12	VCC	Supply Voltage

Pin No.	Name	Description
13	GND	Ground
14	GND	Ground
15	GND	Ground
16	GND	Ground
17	ANT	Antenna
18	GND	Ground
19	GND	Ground
20	GND	Ground
21	GND	Ground
22	GND	Ground
23	VCC	Supply Voltage
24	C1	Switch Control

DATA SHEET
SE5512L: Dual-Band 802.11a/b/g/n Wireless LAN Front-End
Preliminary Information

Absolute Maximum Ratings

These are stress ratings only. Exposure to stresses beyond these maximum ratings may cause permanent damage to, or affect the reliability of the device. Avoid operating the device outside the recommended operating conditions defined below. This device is ESD sensitive. Handling and assembly of this device should be at ESD protected workstations.

Symbol	Definition	Min.	Max.	Unit
V _{CC}	Supply Voltage	-0.3	3.6	V
PU	ENa, ENg, C0, C1	-0.3	3.6	V
TX _{RF}	Ta, Tg, ANT terminated in 6:1 load or better	-	12.0	dBm
T _A	Operating Temperature Range	-40	85	°C
T _{STG}	Storage Temperature Range	-40	150	°C
ESD _{HBM}	JEDEC JESD22-A114 all pins	-	1,000	V

Recommended Operating Conditions

Symbol	Parameter	Min.	Typ.	Max.	Unit
V _{CC}	Supply Voltage	3.0	3.3	3.6	V
T _A	Ambient Temperature	-40	25	85	°C

DC Electrical Characteristics

Conditions: V_{CC} = 3.3 V, T_A = 25 °C, as measured on Skyworks Solutions' SE5512L-EV1 evaluation board (de-embedded to device), all unused ports terminated with 50 ohms, unless otherwise noted

Symbol	Parameter	Conditions	Min.	Typ.	Max.	Unit
I _{CC-G}	Total 802.11g Transmit Supply Current	P _{OUT} = 18 dBm, 54 Mbps OFDM signal, 64 QAM ENg = 3.3 V, ENa = 0 V, 100% duty cycle	-	150	-	mA
I _{CC-B}	Total 802.11b Transmit Supply Current	P _{OUT} = 19 dBm, 11 Mbps CCK signal, BT = 0.45, ENg = 3.3 V, ENa = 0 V, 100% duty cycle	-	175	-	mA
I _{CC-A}	Total 802.11a Transmit Supply Current	P _{OUT} = 16 dBm, 54 Mbps OFDM signal, 64 QAM, ENa = 3.3 V, ENg = 0 V, 100% duty cycle	-	210	-	mA
I _{CC-Rxa}	Total Icc in Rx 5G band	5G LNA enabled	-	19	-	mA
I _{CC-Rxg}	Total Icc in Rx 2G band	2G LNA enabled	-	18	-	mA
I _{CC-OFF}	Total Supply Current	No RF, ENg = ENa = 0 V	-	50	180	µA

DATA SHEET
SE5512L: Dual-Band 802.11a/b/g/n Wireless LAN Front-End
Preliminary Information

PA Logic Characteristics

Conditions: $V_{CC} = 3.3\text{ V}$, $T_A = 25\text{ }^\circ\text{C}$, as measured on Skyworks Solutions' SE5512L-EV1 evaluation board (de-embedded to device), all unused ports terminated with 50 ohms, unless otherwise noted.

Symbol	Parameter	Conditions	Min.	Typ.	Max.	Unit
V_{ENH}	Logic High Voltage for ENg, ENa (Module On)	-	1.8	-	V_{CC}	V
V_{ENL}	Logic Low Voltage ENg, ENa (Module Off)	-	0	-	0.4	V
I_{ENH}	Input Current Logic High Voltage (ENg, ENa)	-	-	50	100	μA
I_{ENL}	Input Current Logic Low Voltage (ENg, ENa)	$V_{CC} = 0.4\text{V}$	-	0	40	μA

Switch/LNA Logic Characteristics

Conditions: $V_{CC} = 3.3\text{ V}$, $V_{EN} = 0\text{ V}$, $T_A = 25\text{ }^\circ\text{C}$, as measured on Skyworks Solutions' SE5512L-EV1 evaluation board (de-embedded to device), all unused ports terminated with 50 ohms, unless otherwise noted.

Symbol	Parameter	Conditions	Min.	Typ.	Max.	Unit
V_{CTL_ON}	Control Voltage C0, C1 (On State)	-	3.0	-	3.6	V
V_{CTL_OFF}	Control Voltage C0, C1 (OFF State)	-	0.0	-	0.4	V
I_{CTL_ON}	Switch Control Bias Current (RF Applied)	On pin (TX, RX) being driven high. RF Applied	-	-	400	μA
I_{CTL_ON}	Switch Control Bias Current (No RF)	On pin (TX, RX) being driven high. No RF	-	-	30	μA

Switch & LNA Control Logic Table

C0	C1	EnG	EnA	Tg ↔ ANT	Ta ↔ ANT	Rg ↔ ANT	Ra ↔ ANT
V_{CTL_OFF}	V_{CTL_ON}	V_{ENH}	V_{ENL}	ON	OFF	OFF	OFF
V_{CTL_OFF}	V_{CTL_OFF}	V_{ENL}	V_{ENH}	OFF	ON	OFF	OFF
V_{CTL_ON}	V_{CTL_OFF}	V_{ENL}	V_{ENL}	OFF	OFF	OFF	LNA ON
V_{CTL_ON}	V_{CTL_ON}	V_{ENL}	V_{ENL}	OFF	OFF	LNA ON	OFF
V_{CTL_OFF}	V_{CTL_OFF}	V_{ENL}	V_{ENL}	Stand By Mode, PAs and LNAs OFF – Low Current Consumption			
All Other States				Not Supported			

DATA SHEET
SE5512L: Dual-Band 802.11a/b/g/n Wireless LAN Front-End
Preliminary Information

2.4 GHz AC Electrical Characteristics

2.4 GHz Transmit Characteristics

Conditions: $V_{CC} = 3.3\text{ V}$, $ENg = 3.3\text{ V}$, $ENa = C0 = C1 = 0\text{ V}$, $T_A = 25\text{ }^\circ\text{C}$, as measured on Skyworks Solutions' SE5512L-EV1 evaluation board, all unused ports terminated with 50 ohms, unless otherwise noted.

Symbol	Parameter	Condition	Min.	Typ.	Max.	Unit
F_{IN}	Frequency Range	-	2400	-	2500	MHz
$P_{802.11g}$	Output power	54 Mbps OFDM signal, 64QAM, EVM = 3.0 %	-	18	-	dBm
$P_{802.11b}$	Output power	11 Mbps CCK signal, BT = 0.45 ACPR($\pm 11\text{MHz}$ offset) < -35 ACPR($\pm 22\text{MHz}$ offset) < -56	-	19	-	dBm
P_{1dB}	P1dB	-	23	25.5	-	dBm
S_{21}	Small Signal Gain	-	25	28	30	dB
ΔS_{21}	Small Signal Gain Variation Over Band	-	-	1.0	2.0	dB
$S_{213.2}$	Gain at Ref-VCO	3200.00 to 3300.00 MHz	-	-	0	dB
2f,3f	Harmonics	$P_{out} \leq 19\text{ dBm}$, 1Mbps, CCK	-	-	-45.2	dBm/MHz
t_r	Rise Time	10 % to 90% of final output power level	-	-	0.5	μs
t_{dr}, t_{df}	Delay and rise/fall Time	50 % of V_{EN} edge and 90/10 % of final output power level	-	-	0.5	μs
S_{11}	Input Return Loss	-	8	10	-	dB
STAB	Stability	CW, $P_{OUT} = 19\text{ dBm}$ 0.1 GHz – 21 GHz Load VSWR = 6:1	All non-harmonically related outputs less than -42 dBm/MHz			
R_u	Ruggedness	$T_g = 12\text{ dBm}$, ANT load varies over 6:1 VSWR	No Irreversible damage			

DATA SHEET
SE5512L: Dual-Band 802.11a/b/g/n Wireless LAN Front-End
Preliminary Information

2.4 GHz Receive Characteristics

Conditions: $V_{CC} = C0 = C1 = 3.3\text{ V}$, $ENg = ENa = 0\text{ V}$, $T_A = 25\text{ }^\circ\text{C}$, as measured on Skyworks Solutions' SE5512L-EV1 evaluation board, all unused ports terminated with 50 ohms, unless otherwise noted.

Symbol	Parameter	Condition	Min.	Typ.	Max.	Unit
F_{OUT}	Frequency Range	-	2400	-	2500	MHz
S_{21}	Receive Gain, LNA Enabled.	2400 – 2485 MHz	10	15	-	dB
ΔS_{21}	Gain Variation	2400 – 2485 MHz, Over any 40MHz band	-	0.2	0.5	dB
NF	Noise Figure	De-embedded to device	-	2.5	2.8	dB
INT	Interferer @1710-1990MHz	With this input , IIP3 can only degrade by 1dB	-10	-	-	dBm
S_{11}	Input Return Loss	-	-	8	-	dB
IP1dB	Input P1dB	$C0 = 3.3\text{ V}$	-	-7	-	dBm
T_{EN}	Enable Time	10% to 90% of RX RF power, from time that C0 is at 50%	-	500	-	nsec

DATA SHEET
SE5512L: Dual-Band 802.11a/b/g/n Wireless LAN Front-End
Preliminary Information

5 GHz AC Electrical Characteristics

5 GHz Transmit Characteristics

Conditions: $V_{CC} = 3.3\text{ V}$, $E_{NA} = 3.3\text{ V}$, $E_{NG} = C_0 = C_1 = 0\text{ V}$, $T_A = 25\text{ }^\circ\text{C}$, as measured on Skyworks Solutions' SE5512L-EV1 evaluation board, all unused ports terminated with 50 ohms, unless otherwise noted.

Symbol	Parameter	Condition	Min.	Typ.	Max.	Unit
F_{IN}	Frequency Range	-	4900	-	5875	MHz
$P_{802.11a}$	Nominal Output Power	54 Mbps OFDM signal, 64 QAM, EVM = 3.0 %	-	16	-	dBm
P_{1dB}	P1dB	-	21	22.5	-	dBm
S_{21}	Small Signal Gain	-	24	-	32	dB
ΔS_{21}	Small Signal Gain Variation Over 40 MHz Channel	-	-	-	0.5	dB
	Small Signal Gain Variation Over sub-bands	-	-	-	3	dB
$S_{213.2}$	Gain	3280 to 3900 MHz	-	3	9	dB
2f,3f	Harmonics	$P_{out} \leq 16\text{ dBm typ}$, 54Mbps, 802.11a OFDM	-	-	-45.2	dBm/MHz
t_r	Rise Time	10 % to 90% of final output power level	-	-	0.5	μs
t_{dr}, t_{df}	Delay and rise/fall Time	50 % of V_{EN} edge and 90/10 % of final output power level	-	-	0.5	μs
S_{11}	Input Return Loss	-	5	7	-	dB
STAB	Stability	64 QAM, $P_{OUT} = 16\text{ dBm}$ 0.1 GHz – 21 GHz Load VSWR = 6:1	All non-harmonically related outputs less than -42 dBm/MHz			
R_u	Ruggedness	$TX_a = 12\text{ dBm}$, ANT load varies over 6:1 VSWR	No Irreversible damage			

DATA SHEET
SE5512L: Dual-Band 802.11a/b/g/n Wireless LAN Front-End
Preliminary Information

5 GHz Receive Characteristics

Conditions: $V_{CC} = C0 = 3.3\text{ V}$, $ENg = ENa = C1 = 0\text{ V}$, $T_A = 25\text{ }^\circ\text{C}$, as measured on Skyworks Solutions' SE5512L-EV1 evaluation board, all unused ports terminated with 50 ohms, unless otherwise noted.

Symbol	Parameter	Condition	Min.	Typ.	Max.	Unit
F_{OUT}	Frequency Range	-	4900	-	5850	MHz
S_{21}	Receive Gain	4900 – 5850 MHz	10	12	-	dB
ΔS_{21}	Gain Variation	4900 – 5850 MHz, Over any 40MHz band	-	1	-	dB
NF	Noise Figure	De-embedded to device	-	2.8	3.0	dB
S_{11}	Return Loss	-	10	15	-	dB
IP1dB	Input P1dB	$C0 = 3.3\text{ V}$	-6.5	-	-	dBm
T_{EN}	Enable Time	10% to 90% of RX RF power, from time that C0 is at 50%	-	500	-	nsec

DATA SHEET
SE5512L: Dual-Band 802.11a/b/g/n Wireless LAN Front-End
Preliminary Information

2.4 GHz Power Detector Characteristic

Conditions: $V_{CC} = 3.3\text{ V}$, $ENg = 3.3\text{ V}$, $ENa = C0 = C1 = 0\text{ V}$, $T_A = 25\text{ }^\circ\text{C}$, as measured on Skyworks Solutions' SE5512L-EV1 evaluation board, all unused ports terminated with 50 ohms, unless otherwise noted.

Symbol	Parameter	Condition	Min.	Typ.	Max.	Unit
F _{OUT}	Frequency Range	-	2400	-	2500	MHz
PDR	Power detect range, peak power	Measured at ANT0 or ANT1	0	-	22	dBm
PDZ _{OUT}	DC Output impedance	-	-	2.7	3	kΩ
PDV _{P21}	Output Voltage, P _{OUT} = 21dBm	-	-	0.85	-	V
PDV _{P18}	Output Voltage, P _{OUT} = 18dBm	-	-	0.65	-	V
PDV _{pnoRF}	Output Voltage, P _{OUT} = No RF	-	-	0.35	-	V
LPF _{-3dB}	Power detect low pass filter -3dB corner frequency	Load = high impedance Typ: 500 kΩ	-	1500	-	kHz

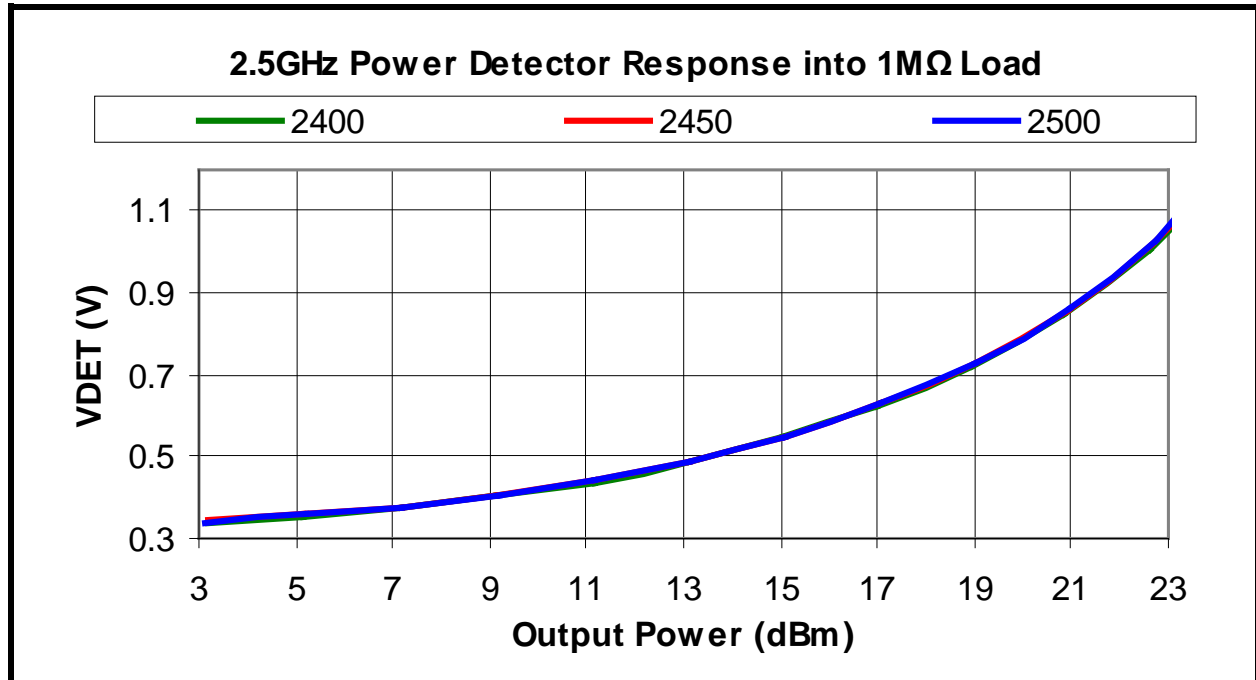

Figure 3: SE5512L Power Detector vs. Output Power over Frequency (CW Signal)

DATA SHEET
SE5512L: Dual-Band 802.11a/b/g/n Wireless LAN Front-End
Preliminary Information

5 GHz Power Detector Characteristic

Conditions: $V_{CC} = 3.3\text{ V}$, $E_{Na} = 3.3\text{ V}$, $E_{Ng} = C0 = C1 = 0\text{ V}$, $T_A = 25\text{ }^\circ\text{C}$, as measured on Skyworks Solutions' SE5512L-EV1 evaluation board, all unused ports terminated with 50 ohms, unless otherwise noted.

Symbol	Parameter	Condition	Min.	Typ.	Max.	Unit
F _{OUT}	Frequency Range	-	4900	-	5850	MHz
PDR	Power detect range, peak power	Measured at ANT	0	-	21	dBm
PDZ _{OUT}	DC Output impedance	-	-	2.7	3.0	kΩ
PDV _{p18}	Output Voltage, P _{OUT} = 18dBm	-	-	0.78	-	V
PDV _{p16}	Output Voltage, P _{OUT} = 16dBm	-	-	0.65	-	V
PDV _{NoRF}	Output Voltage, P _{OUT} = No RF	-	-	0.35	-	V
LPF _{-3dB}	Power detect low pass filter -3dB corner frequency	Load = high impedance Typ: 500 kΩ	-	1500	-	kHz

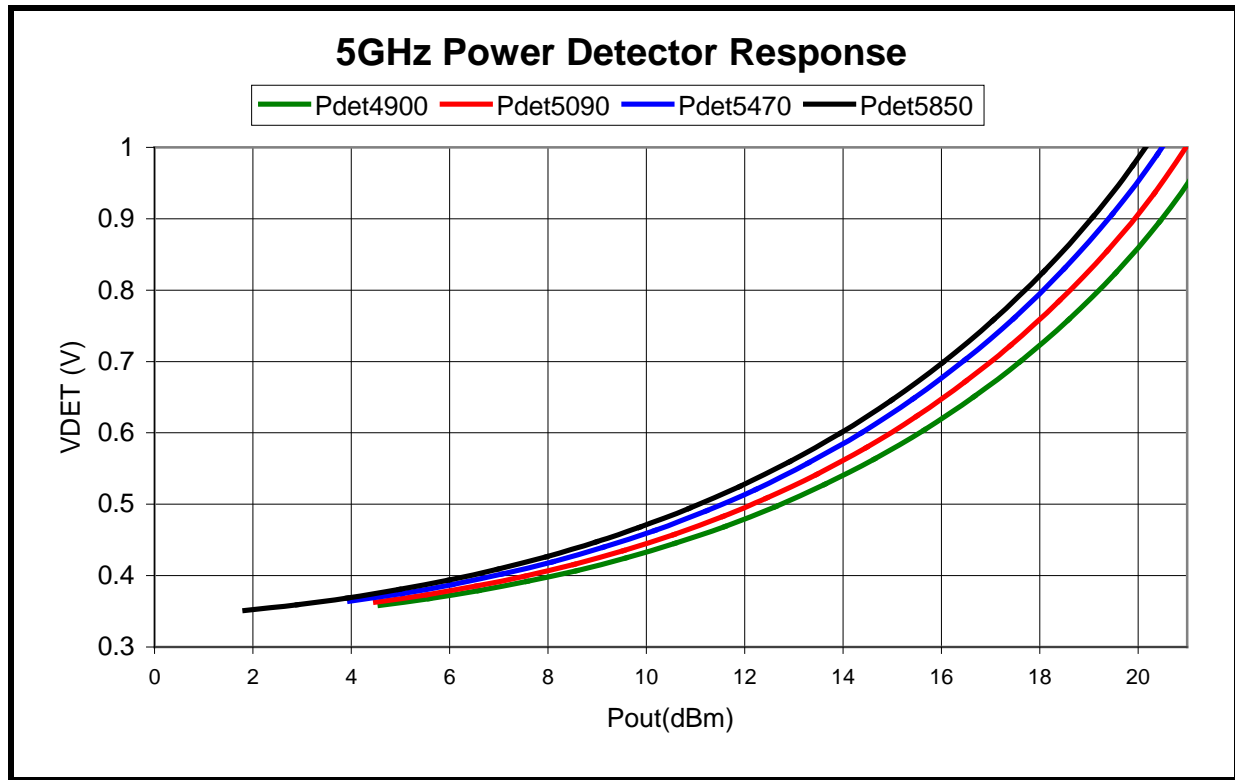

Figure 4: Preliminary SE5512L Power Detector vs. Output Power over Frequency (CW Signal)

DATA SHEET
SE5512L: Dual-Band 802.11a/b/g/n Wireless LAN Front-End
Preliminary Information

Package Drawing

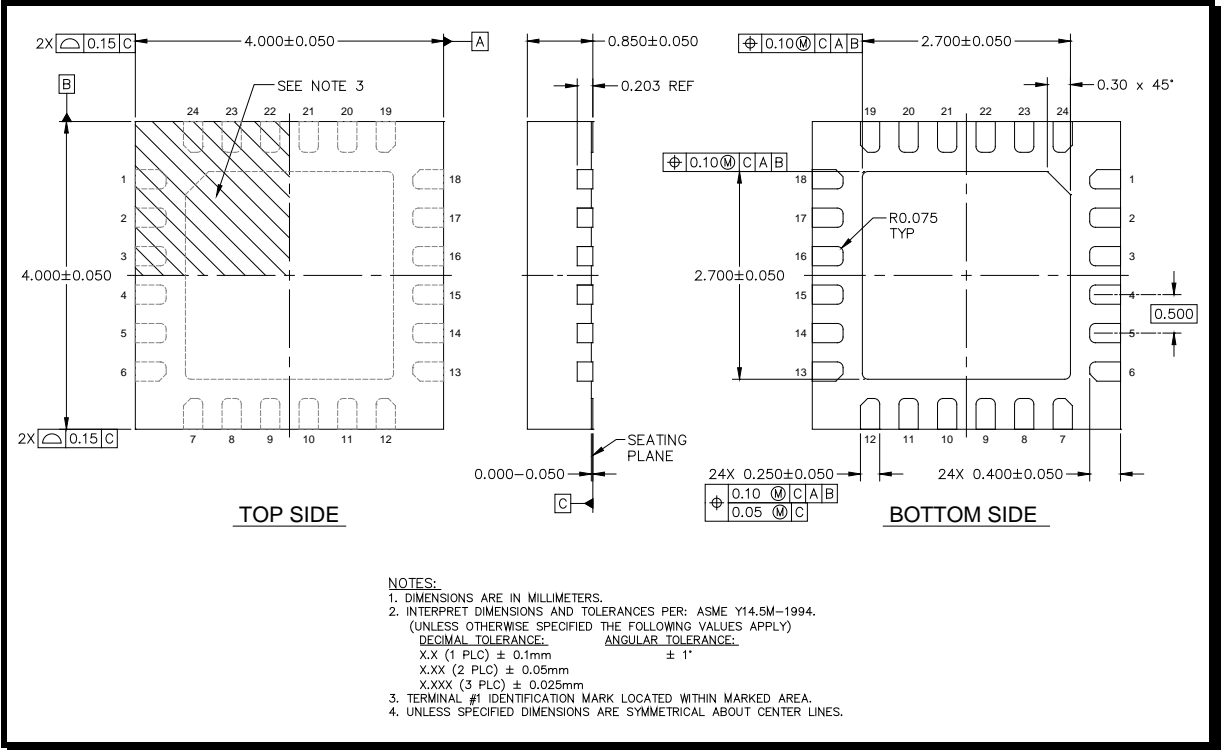
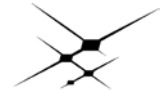

Figure 5: Package Drawing: Topside



DATA SHEET
SE5512L: Dual-Band 802.11a/b/g/n Wireless LAN Front-End
Preliminary Information

Recommended Land and Solder Patterns

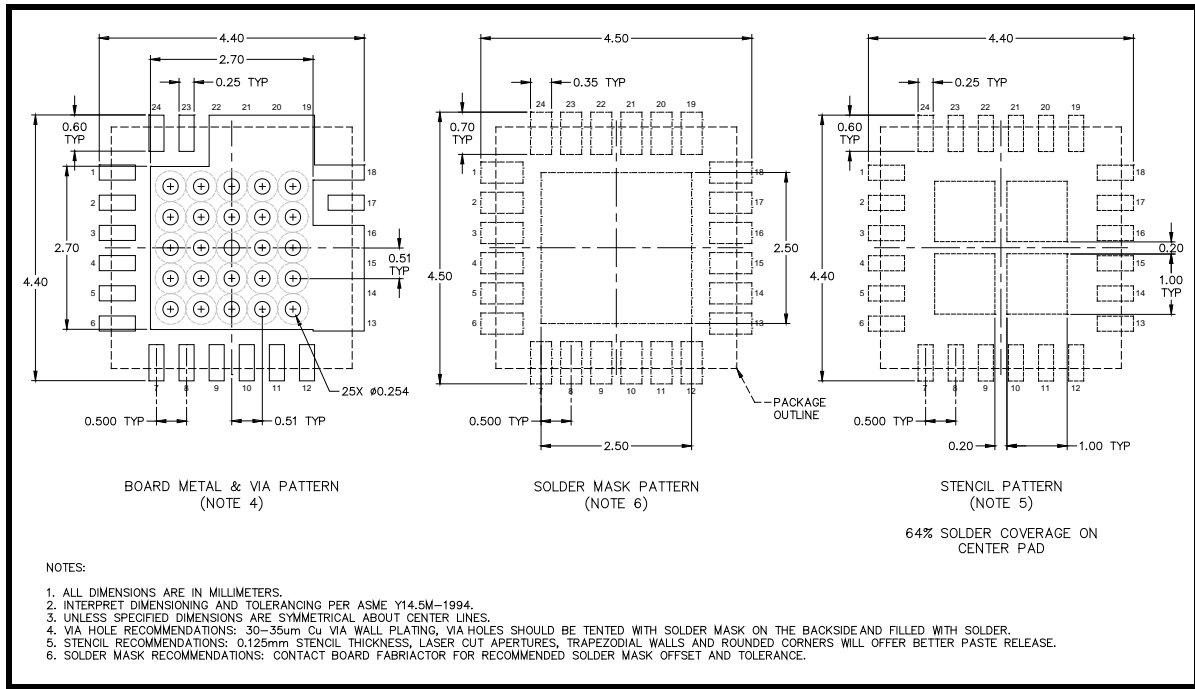

Figure 6: Recommended Land and Solder Patterns

DATA SHEET
SE5512L: Dual-Band 802.11a/b/g/n Wireless LAN Front-End
Preliminary Information

Package Handling Information

Because of its sensitivity to moisture absorption, instructions on the shipping container label must be followed regarding exposure to moisture after the container seal is broken, otherwise, problems related to moisture absorption may occur when the part is subjected to high temperature during solder assembly. The SE5512L is capable of withstanding a Pb free solder reflow. Care must be taken when attaching this product, whether it is done manually or in a production solder reflow environment. If the part is manually attached, precaution should be taken to insure that the device is not subjected to temperatures above its rated peak temperature for an extended period of time. For details on both attachment techniques, precautions, and handling procedures recommended, please refer to:

- “Quad Flat No-Lead Module Solder Reflow & Rework Information”, *Document Number QAD-00045*
- “Handling, Packing, Shipping and Use of Moisture Sensitive QFN”, *Document Number QAD-00044*

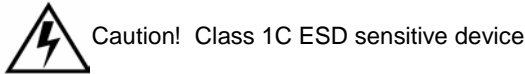

Product Branding

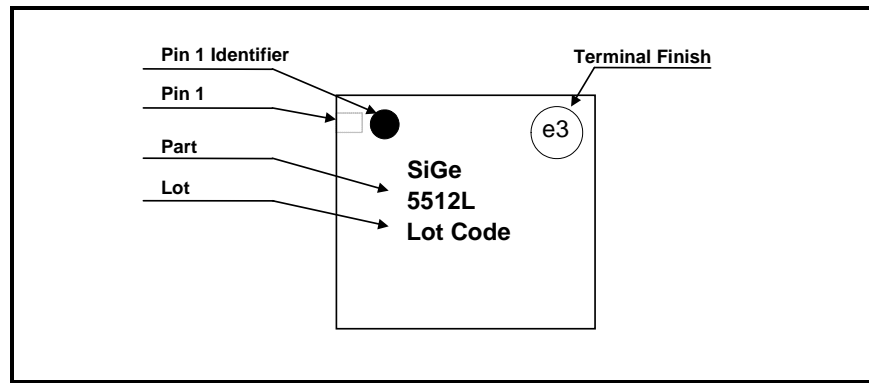

Figure 7: SE5512L Branding Information

DATA SHEET
SE5512L: Dual-Band 802.11a/b/g/n Wireless LAN Front-End
Preliminary Information

Tape and Reel Information

Parameter	Value
Devices Per Reel	3000
Reel Diameter	13 inches
Tape Width	12 millimeters

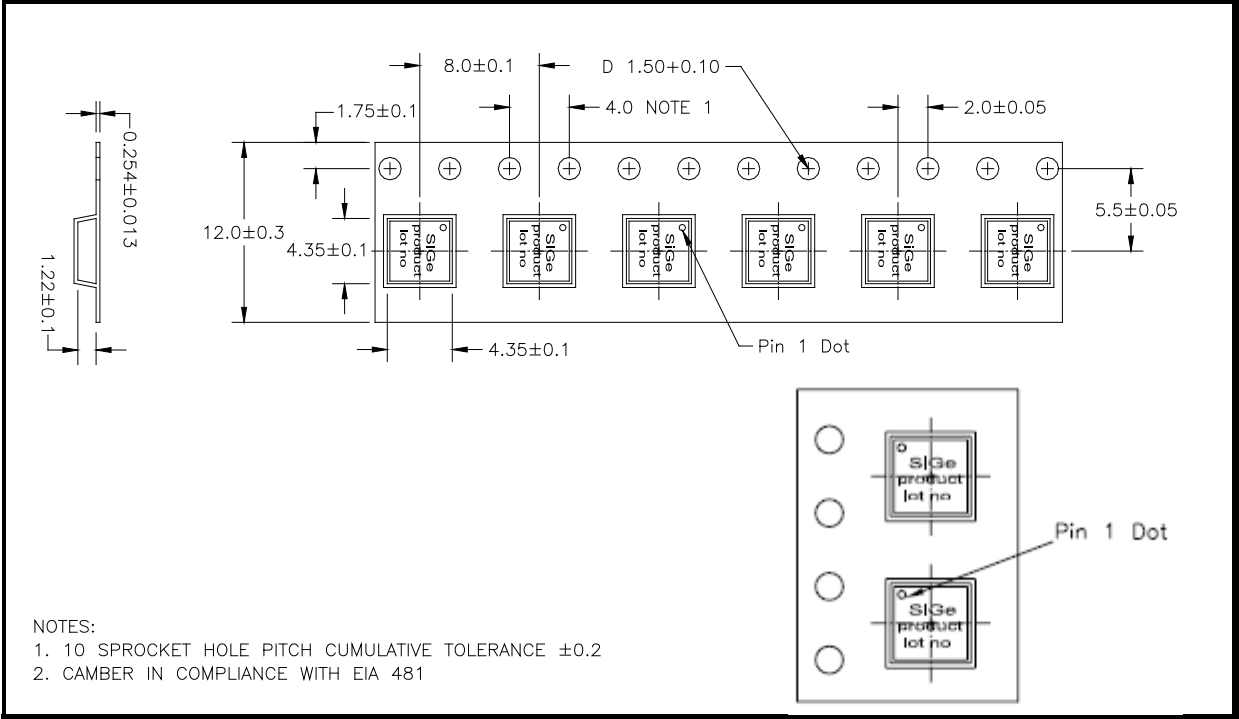

Figure 8: Detailed Tape and Reel Information (All dimensions in Millimeters)



DATA SHEET
SE5512L: Dual-Band 802.11a/b/g/n Wireless LAN Front-End
Preliminary Information

Document Change History

Revision	Date	Notes
1.0	Aug 10, 2010	Create
1.1	Sep 30, 2010	Updated 2GHz LNA gain variation over a single channel. Updated EN (high) current limit Updated 5GHz Gain (min) limit.
1.2	Oct 7, 2010	Added "Stand By" mode setting to switch control logic table
1.3	Jan 27, 2011	Updated MSL rating to MSL1 Updated ESD rating to Class 1C
1.4	Sep 25, 2011	Updated recommended operating conditions to Industrial level
1.5	Feb 17, 2012	Updated marking diagram
1.6	Apr 03, 2012	Updated with Skyworks logo and disclaimer statement

Copyright © 2012 Skyworks Solutions, Inc. All Rights Reserved.

Information in this document is provided in connection with Skyworks Solutions, Inc. ("Skyworks") products or services. These materials, including the information contained herein, are provided by Skyworks as a service to its customers and may be used for informational purposes only by the customer. Skyworks assumes no responsibility for errors or omissions in these materials or the information contained herein. Skyworks may change its documentation, products, services, specifications or product descriptions at any time, without notice. Skyworks makes no commitment to update the materials or information and shall have no responsibility whatsoever for conflicts, incompatibilities, or other difficulties arising from any future changes.

No license, whether express, implied, by estoppel or otherwise, is granted to any intellectual property rights by this document. Skyworks assumes no liability for any materials, products or information provided hereunder, including the sale, distribution, reproduction or use of Skyworks products, information or materials, except as may be provided in Skyworks Terms and Conditions of Sale.

THE MATERIALS, PRODUCTS AND INFORMATION ARE PROVIDED "AS IS" WITHOUT WARRANTY OF ANY KIND, WHETHER EXPRESS, IMPLIED, STATUTORY, OR OTHERWISE, INCLUDING FITNESS FOR A PARTICULAR PURPOSE OR USE, MERCHANTABILITY, PERFORMANCE, QUALITY OR NON-INFRINGEMENT OF ANY INTELLECTUAL PROPERTY RIGHT; ALL SUCH WARRANTIES ARE HEREBY EXPRESSLY DISCLAIMED. SKYWORKS DOES NOT WARRANT THE ACCURACY OR COMPLETENESS OF THE INFORMATION, TEXT, GRAPHICS OR OTHER ITEMS CONTAINED WITHIN THESE MATERIALS. SKYWORKS SHALL NOT BE LIABLE FOR ANY DAMAGES, INCLUDING BUT NOT LIMITED TO ANY SPECIAL, INDIRECT, INCIDENTAL, STATUTORY, OR CONSEQUENTIAL DAMAGES, INCLUDING WITHOUT LIMITATION, LOST REVENUES OR LOST PROFITS THAT MAY RESULT FROM THE USE OF THE MATERIALS OR INFORMATION, WHETHER OR NOT THE RECIPIENT OF MATERIALS HAS BEEN ADVISED OF THE POSSIBILITY OF SUCH DAMAGE.

Skyworks products are not intended for use in medical, lifesaving or life-sustaining applications, or other equipment in which the failure of the Skyworks products could lead to personal injury, death, physical or environmental damage. Skyworks customers using or selling Skyworks products for use in such applications do so at their own risk and agree to fully indemnify Skyworks for any damages resulting from such improper use or sale.

Customers are responsible for their products and applications using Skyworks products, which may deviate from published specifications as a result of design defects, errors, or operation of products outside of published parameters or design specifications. Customers should include design and operating safeguards to minimize these and other risks. Skyworks assumes no liability for applications assistance, customer product design, or damage to any equipment resulting from the use of Skyworks products outside of stated published specifications or parameters.

Skyworks, the Skyworks symbol, and "Breakthrough Simplicity" are trademarks or registered trademarks of Skyworks Solutions, Inc., in the United States and other countries. Third-party brands and names are for identification purposes only, and are the property of their respective owners. Additional information, including relevant terms and conditions, posted at www.skyworksinc.com, are incorporated by reference.

Данный компонент на территории Российской Федерации

Вы можете приобрести в компании MosChip.

Для оперативного оформления запроса Вам необходимо перейти по данной ссылке:

<http://moschip.ru/get-element>

Вы можете разместить у нас заказ для любого Вашего проекта, будь то серийное производство или разработка единичного прибора.

В нашем ассортименте представлены ведущие мировые производители активных и пассивных электронных компонентов.

Нашей специализацией является поставка электронной компонентной базы двойного назначения, продукции таких производителей как XILINX, Intel (ex.ALTERA), Vicor, Microchip, Texas Instruments, Analog Devices, Mini-Circuits, Amphenol, Glenair.

Сотрудничество с глобальными дистрибьюторами электронных компонентов, предоставляет возможность заказывать и получать с международных складов практически любой перечень компонентов в оптимальные для Вас сроки.

На всех этапах разработки и производства наши партнеры могут получить квалифицированную поддержку опытных инженеров.

Система менеджмента качества компании отвечает требованиям в соответствии с ГОСТ Р ИСО 9001, ГОСТ РВ 0015-002 и ЭС РД 009

Офис по работе с юридическими лицами:

105318, г.Москва, ул.Щербаковская д.3, офис 1107, 1118, ДЦ «Щербаковский»

Телефон: +7 495 668-12-70 (многоканальный)

Факс: +7 495 668-12-70 (доб.304)

E-mail: info@moschip.ru

Skype отдела продаж:

moschip.ru

moschip.ru_4

moschip.ru_6

moschip.ru_9