

## Rail-to-rail input/output 10 $\mu$ A, 120 kHz CMOS operational amplifiers

Datasheet - production data

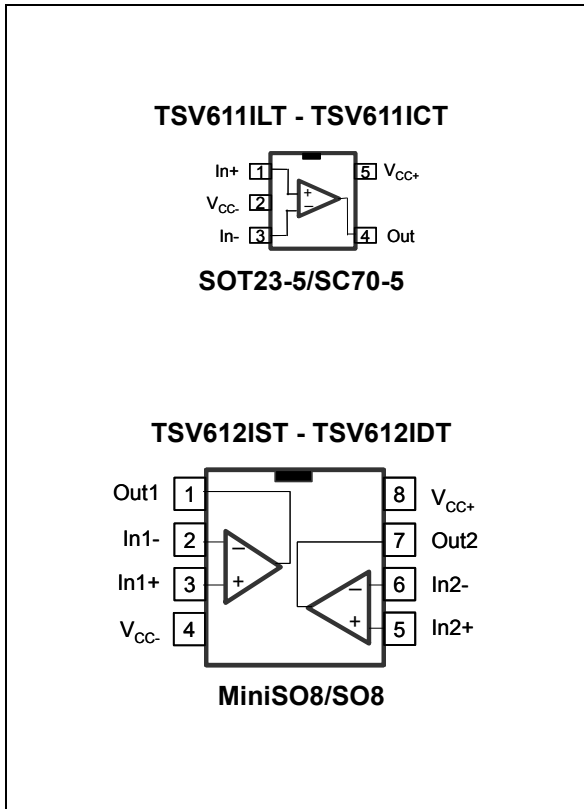

### Applications

- Battery-powered applications
- Smoke detectors
- Proximity sensors
- Portable devices
- Signal conditioning
- Active filtering
- Medical instrumentation

### Description

The TSV61x family of single and dual operational amplifiers offers low voltage, low power operation, and rail-to-rail input and output.

The devices also feature an ultra-low input bias current as well as a low input offset voltage.

The TSV61x have a gain bandwidth product of 120 kHz while consuming only 10  $\mu$ A at 5 V.

These features make the TSV61x family ideal for sensor interfaces, battery supplied and portable applications, as well as active filtering.

### Features

- Rail-to-rail input and output
- Low power consumption: 10  $\mu$ A typ at 5 V
- Low supply voltage: 1.5 to 5.5 V
- Gain bandwidth product: 120 kHz typ
- Unity gain stable
- Low input offset voltage: 800  $\mu$ V max (A version)
- Low input bias current: 1 pA typ
- Temperature range: -40 to 85  $^{\circ}$ C

# Contents

- 1 Absolute maximum ratings and operating conditions ..... 3**
- 2 Electrical characteristics ..... 4**
- 3 Application information ..... 12**
  - 3.1 Operating voltages ..... 12
  - 3.2 Rail-to-rail input ..... 12
  - 3.3 Rail-to-rail output ..... 12
  - 3.4 Driving resistive and capacitive loads ..... 13
  - 3.5 PCB layouts ..... 13
  - 3.6 Macromodel ..... 13
- 4 Package information ..... 14**
  - 4.1 SOT23-5 package information ..... 15
  - 4.2 SC70-5 (SOT323-5) package information ..... 16
  - 4.3 SO8 package information ..... 17
  - 4.4 MiniSO8 package information ..... 18
- 5 Ordering information ..... 19**
- 6 Revision history ..... 20**

# 1 Absolute maximum ratings and operating conditions

**Table 1. Absolute maximum ratings**

Symbol	Parameter	Value	Unit
$V_{CC}$	Supply voltage <sup>(1)</sup>	6	V
$V_{id}$	Differential input voltage <sup>(2)</sup>	$\pm V_{CC}$	
$V_{in}$	Input voltage <sup>(3)</sup>	$(V_{CC-}) - 0.2$ to $(V_{CC+}) + 0.2$	
$T_{stg}$	Storage temperature	-65 to 150	°C
$R_{thja}$	Thermal resistance junction to ambient <sup>(4)</sup> <sup>(5)</sup>		°C/W
	SC70-5	205	
	SOT23-5	250	
	MiniSO8	190	
	SO8	125	
$T_j$	Maximum junction temperature	150	°C
ESD	HBM: human body model <sup>(6)</sup>	4	kV
	MM: machine model <sup>(7)</sup>	200	V
	CDM: charged device model <sup>(8)</sup>	1.5	kV
	Latch-up immunity	200	mA

- All voltage values, except differential voltage are with respect to network ground terminal.
- Differential voltages are the non-inverting input terminal with respect to the inverting input terminal.
- $V_{CC}$ - $V_{in}$  must not exceed 6 V.
- Short-circuits can cause excessive heating and destructive dissipation.
- $R_{th}$  are typical values.
- Human body model: 100 pF discharged through a 1.5 k $\Omega$  resistor between two pins of the device, done for all couples of pin combinations with other pins floating.
- Machine model: a 200 pF cap is charged to the specified voltage, then discharged directly between two pins of the device with no external series resistor (internal resistor < 5  $\Omega$ ), done for all couples of pin combinations with other pins floating.
- Charged device model: all pins plus package are charged together to the specified voltage and then discharged directly to ground.

**Table 2. Operating conditions**

Symbol	Parameter	Value	Unit
$V_{CC}$	Supply voltage	1.5 to 5.5	V
$V_{icm}$	Common mode input voltage range	$(V_{CC-}) - 0.1$ to $(V_{CC+}) + 0.1$	
$T_{oper}$	Operating free air temperature range	-40 to 85	°C

## 2 Electrical characteristics

**Table 3. Electrical characteristics at  $V_{CC+} = 1.8\text{ V}$  with  $V_{CC-} = 0\text{ V}$ ,  $V_{icm} = V_{CC}/2$ ,  $T_{amb} = 25\text{ °C}$ , and  $R_L$  connected to  $V_{CC}/2$  (unless otherwise specified)**

Symbol	Parameter	Conditions	Min.	Typ.	Max.	Unit
<b>DC performance</b>						
$V_{io}$	Offset voltage	TSV61x			4	mV
		TSV61xA			0.8	
		$T_{min.} < T_{op} < T_{max.}$ TSV61x			5	
		$T_{min.} < T_{op} < T_{max.}$ TSV61xA			2	
$\Delta V_{io}/\Delta T$	Input offset voltage drift			2		$\mu\text{V}/\text{°C}$
$I_{io}$	Input offset current ( $V_{out} = V_{CC}/2$ )			1	$10^{(1)}$	pA
		$T_{min.} < T_{op} < T_{max.}$		1	100	
$I_{ib}$	Input bias current ( $V_{out} = V_{CC}/2$ )			1	$10^{(1)}$	pA
		$T_{min.} < T_{op} < T_{max.}$		1	100	
CMR	Common mode rejection ratio $20 \log(\Delta V_{ic}/\Delta V_{io})$	$0\text{ V to }1.8\text{ V}$ , $V_{out} = 0.9\text{ V}$	55	71		dB
		$T_{min.} < T_{op} < T_{max.}$	53			
$A_{vd}$	Large signal voltage gain	$R_L = 10\text{ k}\Omega$ , $V_{out} = 0.5\text{ V to }1.3\text{ V}$	78	83		dB
		$T_{min.} < T_{op} < T_{max.}$	74			
$V_{OH}$	High level output voltage ( $V_{OH} = V_{CC} - V_{out}$ )	$R_L = 10\text{ k}\Omega$ $T_{min.} < T_{op} < T_{max.}$		4	35 50	mV
$V_{OL}$	Low level output voltage	$R_L = 10\text{ k}\Omega$ $T_{min.} < T_{op} < T_{max.}$		7	35 50	
$I_{out}$	Isink	$V_o = 1.8\text{ V}$ $T_{min.} < T_{op} < T_{max.}$	9 9	13		mA
	Isource	$V_o = 0\text{ V}$ $T_{min.} < T_{op} < T_{max.}$	8 8	10		
$I_{CC}$	Supply current (per operator)	No load, $V_{out} = V_{CC}/2$	6.5	9	12	$\mu\text{A}$
		$T_{min.} < T_{op} < T_{max.}$	6		12.5	
<b>AC performance</b>						
GBP	Gain bandwidth product			100		kHz
$\phi_m$	Phase margin	$R_L = 10\text{ k}\Omega$ , $C_L = 20\text{ pF}$		60		Degrees
$G_m$	Gain margin			9.5		dB
SR	Slew rate	$R_L = 10\text{ k}\Omega$ , $C_L = 20\text{ pF}$ , $V_{out} = 0.5\text{ V to }1.3\text{ V}$		0.03		$\text{V}/\mu\text{s}$

**Table 3. Electrical characteristics at  $V_{CC+} = 1.8\text{ V}$  with  $V_{CC-} = 0\text{ V}$ ,  $V_{icm} = V_{CC}/2$ ,  $T_{amb} = 25\text{ °C}$ , and  $R_L$  connected to  $V_{CC}/2$  (unless otherwise specified) (continued)**

Symbol	Parameter	Conditions	Min.	Typ.	Max.	Unit
$e_n$	Equivalent input noise voltage	$f = 1\text{ kHz}$		110		$\frac{nV}{\sqrt{Hz}}$
THD+N	Total harmonic distortion + noise	$F_{in} = 1\text{ kHz}$ , $A_v = 1$ , $V_{out} = 1\text{ V}_{pp}$ , $R_L = 100\text{ k}\Omega$ , $BW = 22\text{ kHz}$		0.07		%

1. Guaranteed by design.

**Table 4. Electrical characteristics at  $V_{CC+} = 3.3\text{ V}$ ,  $V_{CC-} = 0\text{ V}$ ,  $V_{icm} = V_{CC}/2$ ,  $T_{amb} = 25\text{ }^{\circ}\text{C}$ ,  $R_L$  connected to  $V_{CC}/2$  (unless otherwise specified)**

Symbol	Parameter		Min.	Typ.	Max.	Unit
<b>DC performance</b>						
$V_{io}$	Offset voltage	TSV61x			4	mV
		TSV61xA			0.8	
		$T_{min} < T_{op} < T_{max}$ TSV61x			5	
		$T_{min} < T_{op} < T_{max}$ TSV61xA			2	
$\Delta V_{io}/\Delta T$	Input offset voltage drift			2		$\mu\text{V}/^{\circ}\text{C}$
$I_{io}$	Input offset current			1	$10^{(1)}$	pA
		$T_{min.} < T_{op} < T_{max.}$		1	100	
$I_{ib}$	Input bias current			1	$10^{(1)}$	pA
		$T_{min.} < T_{op} < T_{max.}$		1	100	
CMR	Common mode rejection ratio $20 \log (\Delta V_{ic}/\Delta V_{io})$	0 V to 3.3 V, $V_{out} = 1.75\text{ V}$	61	76		dB
		$T_{min.} < T_{op} < T_{max.}$	58			
$A_{vd}$	Large signal voltage gain	$R_L = 10\text{ k}\Omega$ , $V_{out} = 0.5\text{ V}$ to $2.8\text{ V}$	85	92		dB
		$T_{min.} < T_{op} < T_{max.}$	83			
$V_{OH}$	High level output voltage ( $V_{OH} = V_{CC} - V_{out}$ )	$R_L = 10\text{ k}\Omega$ $T_{min.} < T_{op} < T_{max.}$		5	35 50	mV
$V_{OL}$	Low level output voltage	$R_L = 10\text{ k}\Omega$ $T_{min.} < T_{op} < T_{max.}$		10	35 50	
$I_{out}$	Isink	$V_o = V_{CC}$ $T_{min.} < T_{op} < T_{max.}$	37 35	44		mA
	Isource	$V_o = 0\text{ V}$ $T_{min.} < T_{op} < T_{max.}$	32 30	38		
$I_{CC}$	Supply current (per operator)	No load, $V_{out} = V_{CC}/2$	6.5	9.5	12.5	$\mu\text{A}$
		$T_{min.} < T_{op} < T_{max.}$	6		13	
<b>AC performance</b>						
GBP	Gain bandwidth product			110		kHz
$\phi_m$	Phase margin	$R_L = 10\text{ k}\Omega$ , $C_L = 20\text{ pF}$		60		Degrees
$G_m$	Gain margin			9.5		dB
SR	Slew rate	$R_L = 10\text{ k}\Omega$ , $C_L = 20\text{ pF}$ , $V_{out} = 0.5\text{ V}$ to $2.8\text{ V}$		0.035		$\text{V}/\mu\text{s}$
$e_n$	Equivalent input noise voltage	$f = 1\text{ kHz}$		110		$\frac{\text{nV}}{\sqrt{\text{Hz}}}$

1. Guaranteed by design.

**Table 5. Electrical characteristics at  $V_{CC+} = 5\text{ V}$ ,  $V_{CC-} = 0\text{ V}$ ,  $V_{icm} = V_{CC}/2$ ,  $T_{amb} = 25\text{ }^{\circ}\text{C}$ ,  $R_L$  connected to  $V_{CC}/2$  (unless otherwise specified)**

Symbol	Parameter		Min.	Typ.	Max.	Unit
<b>DC performance</b>						
$V_{io}$	Offset voltage	TSV61x			4	mV
		TSV61xA			0.8	
		$T_{min} < T_{op} < T_{max}$ TSV61x			5	
		$T_{min} < T_{op} < T_{max}$ TSV61xA			2	
$\Delta V_{io}/\Delta T$	Input offset voltage drift			2		$\mu\text{V}/^{\circ}\text{C}$
$I_{io}$	Input offset current			1	10 <sup>(1)</sup>	pA
		$T_{min} < T_{op} < T_{max}$ .		1	100	
$I_{ib}$	Input bias current			1	10 <sup>(1)</sup>	pA
		$T_{min} < T_{op} < T_{max}$ .		1	100	
CMR	Common mode rejection ratio $20 \log (\Delta V_{ic}/\Delta V_{io})$	0 V to 5 V, $V_{out} = 2.5\text{ V}$	64	80		dB
		$T_{min} < T_{op} < T_{max}$ .	63			
SVR	Supply voltage rejection ratio $20 \log (\Delta V_{cc}/\Delta V_{io})$	$V_{cc} = 1.8\text{ to }5\text{ V}$	76	93		dB
		$T_{min} < T_{op} < T_{max}$ .	74			
$A_{vd}$	Large signal voltage gain	$R_L = 10\text{ k}\Omega$ , $V_{out} = 0.5\text{ V to }4.5\text{ V}$	88	93		dB
		$T_{min} < T_{op} < T_{max}$	85			
$V_{OH}$	High level output voltage ( $V_{OH} = V_{CC} - V_{out}$ )	$R_L = 10\text{ k}\Omega$ $T_{min} < T_{op} < T_{max}$ .		7	35 50	mV
$V_{OL}$	Low level output voltage	$R_L = 10\text{ k}\Omega$ $T_{min} < T_{op} < T_{max}$ .		16	35 50	
$I_{out}$	Isink	$V_o = V_{CC}$ $T_{min} < T_{op} < T_{max}$ .	52 42	57		mA
	Isource	$V_o = 0\text{ V}$ $T_{min} < T_{op} < T_{max}$ .	58 49	63		
$I_{CC}$	Supply current (per operator)	No load, $V_{out} = V_{CC}/2$	7.5	10.5	14	$\mu\text{A}$
		$T_{min} < T_{op} < T_{max}$ .	7		15	
<b>AC performance</b>						
GBP	Gain bandwidth product			120		kHz
$\phi_m$	Phase margin	$R_L = 10\text{ k}\Omega$ , $C_L = 20\text{ pF}$		62		Degrees
$G_m$	Gain margin			10		dB
SR	Slew rate	$R_L = 10\text{ k}\Omega$ , $C_L = 20\text{ pF}$ , $V_{out} = 0.5\text{V to }4.5\text{V}$		0.04		V/ $\mu\text{s}$

**Table 5. Electrical characteristics at  $V_{CC+} = 5\text{ V}$ ,  $V_{CC-} = 0\text{ V}$ ,  $V_{icm} = V_{CC}/2$ ,  $T_{amb} = 25\text{ °C}$ ,  $R_L$  connected to  $V_{CC}/2$  (unless otherwise specified) (continued)**

Symbol	Parameter		Min.	Typ.	Max.	Unit
$e_n$	Equivalent input noise voltage	$f = 1\text{ kHz}$		105		$\frac{nV}{\sqrt{Hz}}$
THD+N	Total harmonic distortion + noise	$F_{in} = 1\text{ kHz}$ , $A_v = 1$ , $V_{out} = 1\text{ V}_{pp}$ , $R_L = 100\text{ k}\Omega$ , $BW = 22\text{ kHz}$		0.02		%

1. Guaranteed by design.



**Figure 1. Supply current vs. supply voltage at  $V_{icm} = V_{CC}/2$**



**Figure 2. Output current vs. output voltage at  $V_{CC} = 1.5V$**

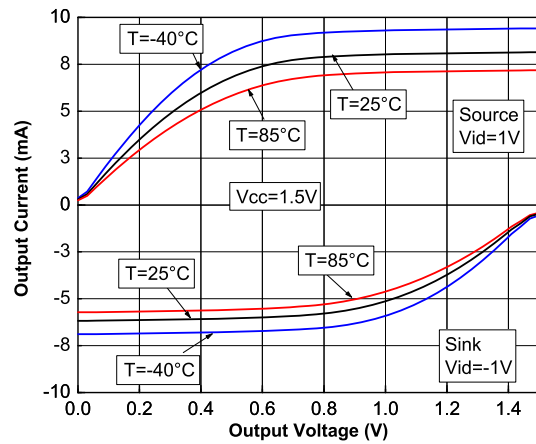

**Figure 3. Output current vs. output voltage at  $V_{CC} = 5V$**



**Figure 4. Voltage gain and phase vs. frequency at  $V_{CC} = 1.5V$**



**Figure 5. Voltage gain and phase vs. frequency at  $V_{CC} = 5V$**



**Figure 6. Phase margin vs. output current**



**Figure 7. Positive slew rate vs. time,  $V_{CC} = 1.5\text{ V}$ ,  $C_{Load} = 100\text{ pF}$ ,  $R_{Load} = 10\text{ k}\Omega$**

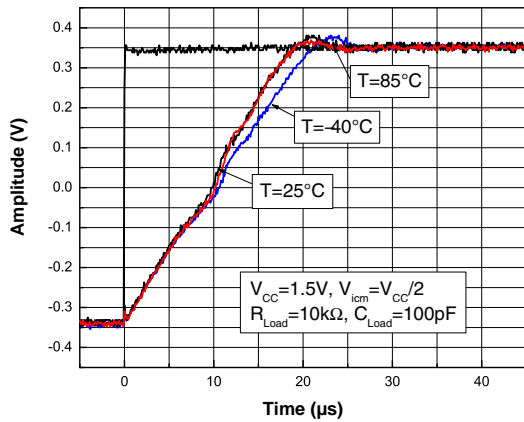

**Figure 8. Negative slew rate vs. time,  $V_{CC} = 1.5\text{ V}$ ,  $C_{Load} = 100\text{ pF}$ ,  $R_{Load} = 10\text{ k}\Omega$**

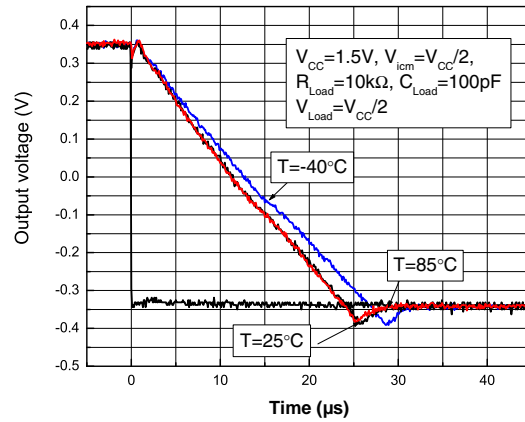

**Figure 9. Positive slew rate vs. time,  $V_{CC} = 5.5\text{ V}$ ,  $C_{Load} = 100\text{ pF}$ ,  $R_{Load} = 100\text{ k}\Omega$**

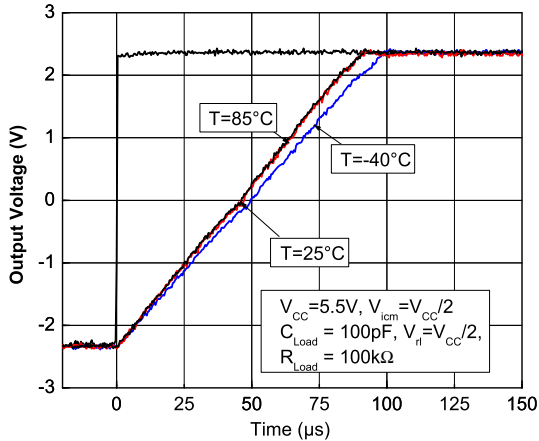

**Figure 10. Negative slew rate vs. time,  $V_{CC} = 5.5\text{ V}$ ,  $C_{Load} = 100\text{ pF}$ ,  $R_{Load} = 100\text{ k}\Omega$**

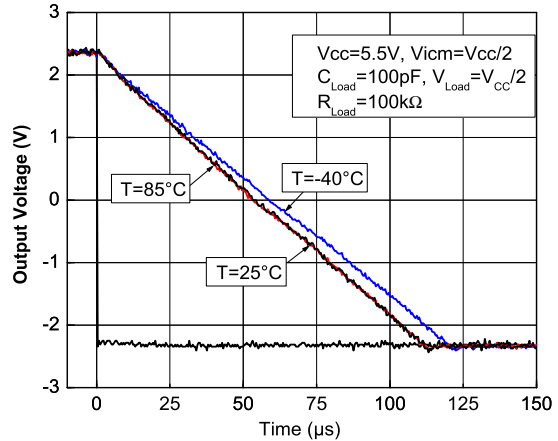

**Figure 11. Slew rate vs. supply voltage**

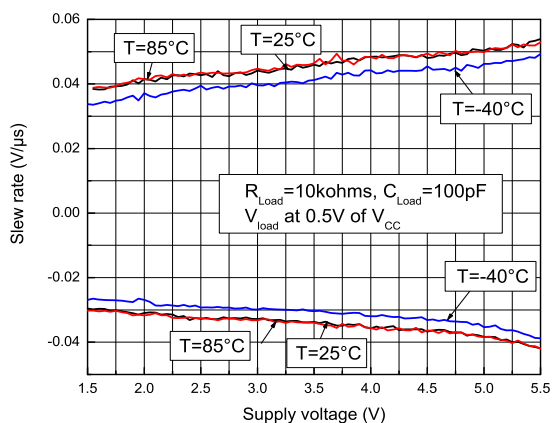

**Figure 12. Noise vs. frequency at  $V_{CC} = 5\text{ V}$**

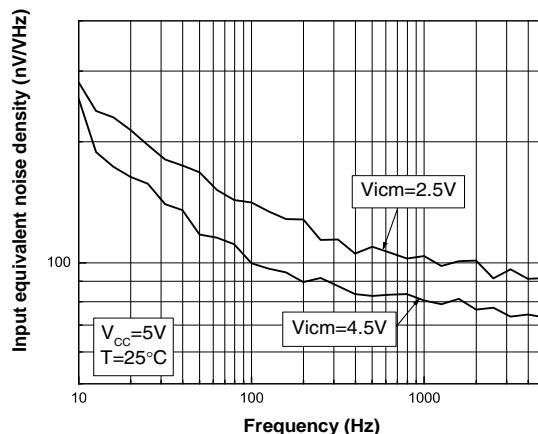

Figure 13. Distortion + noise vs. frequency



Figure 14. Distortion + noise vs. output voltage



Figure 15. Voltage gain and phase vs. frequency at  $V_{CC} = 1.8 V$  (based on simulation results)

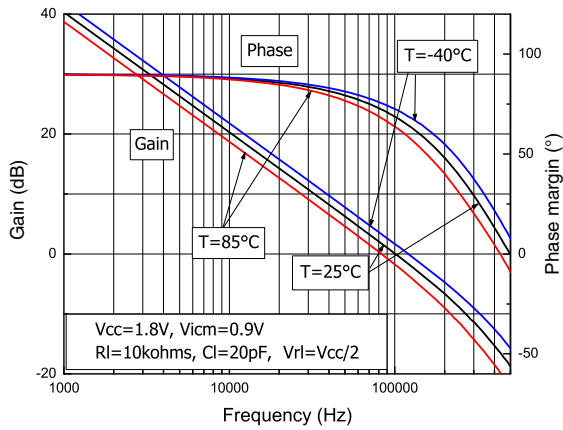

Figure 16. Voltage gain and phase vs. frequency at  $V_{CC} = 5 V$  (based on simulation results)



### 3 Application information

#### 3.1 Operating voltages

The TSV61x can operate from 1.5 to 5.5 V. The parameters are fully specified for 1.8, 3.3, and 5 V power supplies. However, the parameters are very stable in the full  $V_{CC}$  range and several characterization curves show the TSV61x characteristics at 1.5 V. Additionally, the main specifications are guaranteed in extended temperature ranges from  $-40\text{ }^{\circ}\text{C}$  to  $85\text{ }^{\circ}\text{C}$ .

#### 3.2 Rail-to-rail input

The TSV61x are built with two complementary PMOS and NMOS input differential pairs. The devices have a rail-to-rail input, and the input common mode range is extended from  $(V_{CC-}) - 0.1\text{ V}$  to  $(V_{CC+}) + 0.1\text{ V}$ . The transition between the two pairs appears at  $(V_{CC+}) - 0.7\text{ V}$ . In the transition region, the performance of CMRR, PSRR,  $V_{IO}$  and THD is slightly degraded (as shown in [Figure 17](#) and [Figure 18](#) for  $V_{IO}$  vs.  $V_{ICM}$ ).

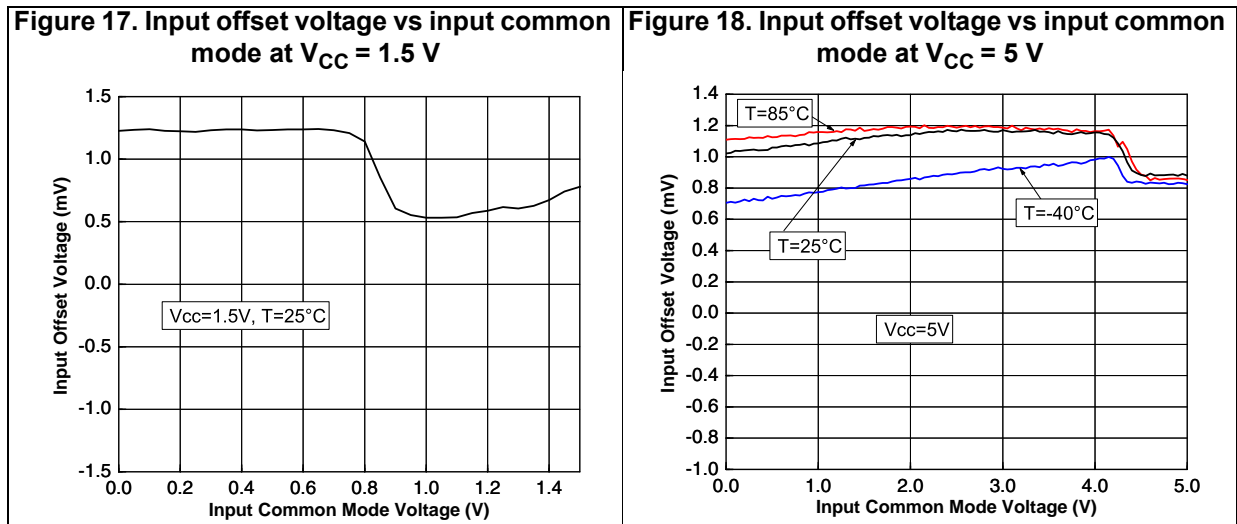

The device is guaranteed without phase reversal.

#### 3.3 Rail-to-rail output

The operational amplifiers' output levels can go close to the rails: less than 35 mV above GND rail and less than 35 mV below  $V_{CC}$  rail when connected to  $10\text{ k}\Omega$  load to  $V_{CC}/2$ .

### 3.4 Driving resistive and capacitive loads

These products are micro-power, low-voltage operational amplifiers optimized to drive rather large resistive loads, above 10 k $\Omega$ . For lower resistive loads, the THD level may significantly increase.

In a follower configuration, these operational amplifiers can drive capacitive loads up to 100 pF with no oscillations. When driving larger capacitive loads, adding an in-series resistor at the output can improve the stability of the devices (see [Figure 19](#) for recommended in-series resistor values). Once the in-series resistor value has been selected, the stability of the circuit should be tested on bench and simulated with the simulation model.

**Figure 19. In-series resistor vs. capacitive load**



### 3.5 PCB layouts

For correct operation, it is advised to add 10 nF decoupling capacitors as close as possible to the power supply pins.

### 3.6 Macromodel

An accurate macromodel of the TSV61x is available on STMicroelectronics' web site at [www.st.com](http://www.st.com). This model is a trade-off between accuracy and complexity (that is, time simulation) of the TSV61x operational amplifiers. It emulates the nominal performances of a typical device within the specified operating conditions mentioned in the datasheet. It also helps to validate a design approach and to select the right operational amplifier, *but it does not replace on-board measurements*.

## 4 Package information

In order to meet environmental requirements, ST offers these devices in different grades of ECOPACK<sup>®</sup> packages, depending on their level of environmental compliance. ECOPACK<sup>®</sup> specifications, grade definitions and product status are available at: [www.st.com](http://www.st.com). ECOPACK<sup>®</sup> is an ST trademark.

### 4.1 SOT23-5 package information

Figure 20. SOT23-5 package outline

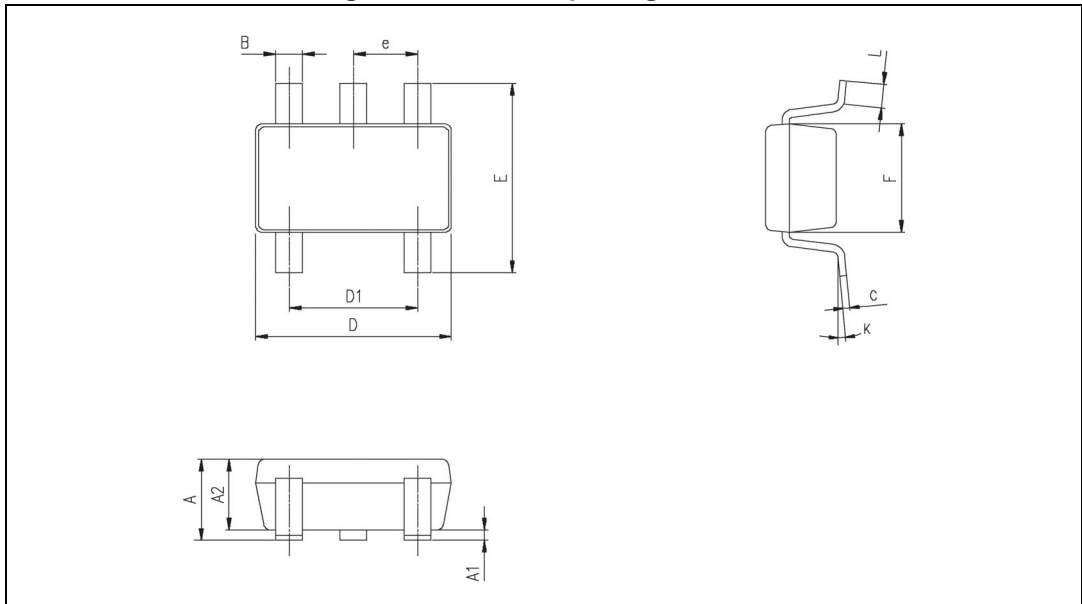

Table 6. SOT23-5 mechanical data

Ref.	Dimensions					
	Millimeters			Inches		
	Min.	Typ.	Max.	Min.	Typ.	Max.
A	0.90	1.20	1.45	0.035	0.047	0.057
A1			0.15			0.006
A2	0.90	1.05	1.30	0.035	0.041	0.051
B	0.35	0.40	0.50	0.013	0.015	0.019
C	0.09	0.15	0.20	0.003	0.006	0.008
D	2.80	2.90	3.00	0.110	0.114	0.118
D1		1.90			0.075	
e		0.95			0.037	
E	2.60	2.80	3.00	0.102	0.110	0.118
F	1.50	1.60	1.75	0.059	0.063	0.069
L	0.10	0.35	0.60	0.004	0.013	0.023
K	0 degrees		10 degrees			

## 4.2 SC70-5 (SOT323-5) package information

Figure 21. SC70-5 (SOT323-5) package outline



Table 7. SC70-5 (SOT323-5) mechanical data

Ref	Dimensions					
	Millimeters			Inches		
	Min	Typ	Max	Min	Typ	Max
A	0.80		1.10	0.315		0.043
A1			0.10			0.004
A2	0.80	0.90	1.00	0.315	0.035	0.039
b	0.15		0.30	0.006		0.012
c	0.10		0.22	0.004		0.009
D	1.80	2.00	2.20	0.071	0.079	0.087
E	1.80	2.10	2.40	0.071	0.083	0.094
E1	1.15	1.25	1.35	0.045	0.049	0.053
e		0.65			0.025	
e1		1.30			0.051	
L	0.26	0.36	0.46	0.010	0.014	0.018
<	0°		8°			



### 4.3 SO8 package information

Figure 22. SO8 package outline



Table 8. SO8 mechanical data

Ref.	Dimensions					
	Millimeters			Inches		
	Min.	Typ.	Max.	Min.	Typ.	Max.
A			1.75			0.069
A1	0.10		0.25	0.004		0.010
A2	1.25			0.049		
b	0.28		0.48	0.011		0.019
c	0.17		0.23	0.007		0.010
D	4.80	4.90	5.00	0.189	0.193	0.197
E	5.80	6.00	6.20	0.228	0.236	0.244
E1	3.80	3.90	4.00	0.150	0.154	0.157
e		1.27			0.050	
h	0.25		0.50	0.010		0.020
L	0.40		1.27	0.016		0.050
L1		1.04			0.040	
k	1°		8°	1°		8°
ccc			0.10			0.004

### 4.4 MiniSO8 package information

Figure 23. MiniSO8 package outline



Table 9. MiniSO8 mechanical data

Ref.	Dimensions					
	Millimeters			Inches		
	Min.	Typ.	Max.	Min.	Typ.	Max.
A			1.1			0.043
A1	0		0.15	0		0.006
A2	0.75	0.85	0.95	0.030	0.033	0.037
b	0.22		0.40	0.009		0.016
c	0.08		0.23	0.003		0.009
D	2.80	3.00	3.20	0.11	0.118	0.126
E	4.65	4.90	5.15	0.183	0.193	0.203
E1	2.80	3.00	3.10	0.11	0.118	0.122
e		0.65			0.026	
L	0.40	0.60	0.80	0.016	0.024	0.031
L1		0.95			0.037	
L2		0.25			0.010	
k	0°		8°	0°		8°
ccc			0.10			0.004

## 5 Ordering information

Table 10. Order codes

Order code	Temperature range	Package	Packing	Marking
TSV611ILT	-40 °C to 85 °C	SOT23-5	Tape and reel	K12
TSV611AILT				K11
TSV611ICT		SC70-5		K12
TSV611AICT				K11
TSV612IDT		SO-8		V612I
TSV612AIDT				V612AI
TSV612IST		MiniSO-8		K113
TSV612AIST				K115

## 6 Revision history

**Table 11. Document revision history**

Date	Revision	Changes
28-May-2009	1	Initial release.
18-Jan-2010	2	Full datasheet for product now in production. Added Figure 1 to Figure 19.
11-May-2017	3	<i>Table 3, Table 4, and Table 5</i> : changed “ $DV_{io}$ to $\Delta V_{io}/\Delta T$ ”, updated $V_{OH}$ parameter information, changed min. values of $V_{OH}$ parameter to max. values. <i>Table 10: Order codes</i> : removed obsolete order codes TSV612ID and TSV612AID

**IMPORTANT NOTICE – PLEASE READ CAREFULLY**

STMicroelectronics NV and its subsidiaries (“ST”) reserve the right to make changes, corrections, enhancements, modifications, and improvements to ST products and/or to this document at any time without notice. Purchasers should obtain the latest relevant information on ST products before placing orders. ST products are sold pursuant to ST’s terms and conditions of sale in place at the time of order acknowledgement.

Purchasers are solely responsible for the choice, selection, and use of ST products and ST assumes no liability for application assistance or the design of Purchasers’ products.

No license, express or implied, to any intellectual property right is granted by ST herein.

Resale of ST products with provisions different from the information set forth herein shall void any warranty granted by ST for such product.

ST and the ST logo are trademarks of ST. All other product or service names are the property of their respective owners.

Information in this document supersedes and replaces information previously supplied in any prior versions of this document.

© 2017 STMicroelectronics – All rights reserved

## Данный компонент на территории Российской Федерации

### Вы можете приобрести в компании MosChip.

Для оперативного оформления запроса Вам необходимо перейти по данной ссылке:

<http://moschip.ru/get-element>

Вы можете разместить у нас заказ для любого Вашего проекта, будь то серийное производство или разработка единичного прибора.

В нашем ассортименте представлены ведущие мировые производители активных и пассивных электронных компонентов.

Нашей специализацией является поставка электронной компонентной базы двойного назначения, продукции таких производителей как XILINX, Intel (ex.ALTERA), Vicor, Microchip, Texas Instruments, Analog Devices, Mini-Circuits, Amphenol, Glenair.

Сотрудничество с глобальными дистрибьюторами электронных компонентов, предоставляет возможность заказывать и получать с международных складов практически любой перечень компонентов в оптимальные для Вас сроки.

На всех этапах разработки и производства наши партнеры могут получить квалифицированную поддержку опытных инженеров.

Система менеджмента качества компании отвечает требованиям в соответствии с ГОСТ Р ИСО 9001, ГОСТ РВ 0015-002 и ЭС РД 009

### Офис по работе с юридическими лицами:

105318, г.Москва, ул.Щербаковская д.3, офис 1107, 1118, ДЦ «Щербаковский»

Телефон: +7 495 668-12-70 (многоканальный)

Факс: +7 495 668-12-70 (доб.304)

E-mail: [info@moschip.ru](mailto:info@moschip.ru)

Skype отдела продаж:

moschip.ru

moschip.ru\_4

moschip.ru\_6

moschip.ru\_9