

# 400MHz to 2.5GHz Upconverter Mixers

## General Description

The MAX2660/MAX2661/MAX2663/MAX2671/MAX2673 miniature, low-cost, low-noise upconverter mixers are designed for low-voltage operation and are ideal for use in portable consumer equipment. Signals at the IF input port are mixed with signals at the local oscillator (LO) port using a double-balanced mixer. These upconverter mixers operate with IF input frequencies between 40MHz and 500MHz, and upconvert to output frequencies as high as 2.5GHz.

These devices offer a wide range of supply currents and output intercept levels to optimize system performance. Supply current is essentially constant over the specified supply voltage range. Additionally, when the devices are in a typical configuration with  $V_{SHDN} = 0$ , a shutdown mode reduces the supply current to less than 1 $\mu$ A.

The MAX2660/MAX2661/MAX2663/MAX2671 are offered in the space-saving 6-pin SOT23 package. For applications requiring balanced IF ports, choose the MAX2673 in the 8-pin  $\mu$ MAX package.

## Applications

400MHz/900MHz/2.4GHz ISM  
Hand-Held Radios  
Wireless Local Area Networks (WLANs)  
IEEE 802.11 and Wireless Data  
Personal Communications Systems (PCS)  
Cellular and Cordless Phones

## Ordering Information

PART	TEMP. RANGE	PIN-PACKAGE	TOP MARK
MAX2660EUT-T	-40°C to +85°C	6 SOT23-6	AAAF
MAX2661EUT-T	-40°C to +85°C	6 SOT23-6	AAAG
MAX2663EUT-T	-40°C to +85°C	6 SOT23-6	AAAL
MAX2671EUT-T	-40°C to +85°C	6 SOT23-6	AAAJ
MAX2673EUA	-40°C to +85°C	8 $\mu$ MAX	—

## Features

- ◆ RF Output Frequencies: 400MHz to 2.5GHz
- ◆ Low Noise Figure: 9.3dB (900MHz, MAX2671)
- ◆ +2.7V to +5.5V Single Supply
- ◆ High Output Intercept Point (OIP3)
  - 5.9dBm at 4.8mA (MAX2660)
  - 7.1dBm at 8.3mA (MAX2661)
  - 0.7dBm at 3.0mA (MAX2663)
  - 9.6dBm at 11.8mA (MAX2671)
  - 7.6dBm at 20.5mA (MAX2673)
- ◆ 1 $\mu$ A Shutdown Mode
- ◆ Ultra-Small Surface-Mount Packaging

## Pin Configurations

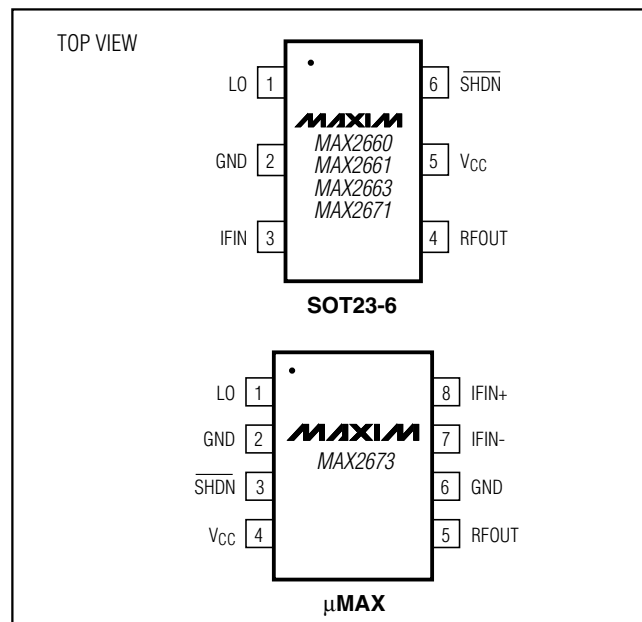

Typical Operating Circuits and Functional Diagram appear at end of data sheet.

## Selector Guide

PART	I <sub>CC</sub> (mA)	OUTPUT IP3 (dBm) AT 900MHz	GAIN (dB) AT 2450MHz	LO BUFFER	SINGLE-ENDED OR DIFFERENTIAL IF	PACKAGE
MAX2660	4.8	5.9	4.6	No	Single Ended	6 SOT23
MAX2661	8.3	7.1	8.2	No	Single Ended	6 SOT23
MAX2663	3.0	0.7	1.4	No	Single Ended	6 SOT23
MAX2671	11.8	9.6	8.9	Yes	Single Ended	6 SOT23
MAX2673	20.5	7.6	8.6	Yes	Differential	8 $\mu$ MAX

# 400MHz to 2.5GHz Upconverter Mixers

## ABSOLUTE MAXIMUM RATINGS

V <sub>CC</sub> to GND .....	-0.3V to +6.0V	Operating Temperature Range .....	-40°C to +85°C
IFIN_ Input Power (50Ω source).....	+10dBm	Junction Temperature .....	+150°C
LO Input Power (50Ω source) .....	+10dBm	Storage Temperature Range .....	-65°C to +160°C
SHDN, RFOUT, IFIN_, LO to GND.....	-0.3V to (V <sub>CC</sub> + 0.3V)	Lead Temperature (soldering, 10sec) .....	+300°C
Continuous Power Dissipation (T <sub>A</sub> = +70°C)			
8-Pin μMAX (derate 4.1mW/°C above +70°C) .....	330mW		
6-Pin SOT23-6 (derate 8.7mW/°C above +70°C) .....	696mW		

Stresses beyond those listed under "Absolute Maximum Ratings" may cause permanent damage to the device. These are stress ratings only, and functional operation of the device at these or any other conditions beyond those indicated in the operational sections of the specifications is not implied. Exposure to absolute maximum rating conditions for extended periods may affect device reliability.

## DC ELECTRICAL CHARACTERISTICS

(V<sub>CC</sub> = +2.7V to +5.5V, SHDN = +2V, T<sub>A</sub> = -40°C to +85°C, unless otherwise noted. Typical values are at V<sub>CC</sub> = SHDN = +3.0V, T<sub>A</sub> = +25°C. Minimum and maximum values are guaranteed over temperature by design and characterization.)

PARAMETER	SYMBOL	CONDITIONS	MIN	TYP	MAX	UNITS
Operating Supply Current (LO and IFIN_ Unconnected)	I <sub>CC</sub>	MAX2660		4.8	6.6	mA
		MAX2661		8.3	11.3	
		MAX2663		3.0	4.1	
		MAX2671		11.8	16.6	
		MAX2673		20.5	26.8	
Shutdown Supply Current	I <sub>CC</sub>	SHDN = GND, MAX2660		0.1		μA
		SHDN = GND, MAX2661		0.2		
		SHDN = GND, MAX2663		0.1		
		SHDN = GND, MAX2671		0.2		
		SHDN = GND, MAX2673		0.8		
		SHDN = 0.5V, V <sub>CC</sub> = 2.7V to 3.6V			5	
		SHDN = 0.5V, V <sub>CC</sub> = 3.6V to 5.5V			15	
Shutdown Input Voltage High	V <sub>IH</sub>		2		V <sub>CC</sub>	V
Shutdown Input Voltage Low	V <sub>IL</sub>		0		0.5	V
Shutdown Input Bias Current	I <sub>IN</sub>		-5	0.2	5	μA

## AC ELECTRICAL CHARACTERISTICS

(V<sub>CC</sub> = SHDN = +3.0V, T<sub>A</sub> = +25°C, unless otherwise noted. Minimum and maximum values are guaranteed by design and characterization.)

PARAMETER	CONDITIONS	MIN	TYP	MAX	UNITS
<b>MAX2660</b> (P <sub>LO</sub> = -5dBm, P <sub>IFIN</sub> = -30dBm, Circuit of Figure 1)					
Conversion Gain	f <sub>IF</sub> = 45MHz, f <sub>LO</sub> = 445MHz, f <sub>RF</sub> = 400MHz		7.0		dB
	f <sub>IF</sub> = 70MHz, f <sub>LO</sub> = 970MHz, f <sub>RF</sub> = 900MHz		7.0		
	f <sub>IF</sub> = 70MHz, f <sub>LO</sub> = 1830MHz, f <sub>RF</sub> = 1900MHz	3.9	5.9	8.1	
	f <sub>IF</sub> = 240MHz, f <sub>LO</sub> = 2210MHz, f <sub>RF</sub> = 2450MHz		4.6		
Gain Variation Over Temperature	f <sub>IF</sub> = 70MHz, f <sub>LO</sub> = 1830MHz, f <sub>RF</sub> = 1900MHz, T <sub>A</sub> = -40°C to +85°C		±1.2	±1.6	dB
Output Third-Order Intercept	f <sub>IF</sub> = 70MHz, f <sub>LO</sub> = 970MHz, f <sub>RF</sub> = 900MHz		5.9		dBm
	f <sub>IF</sub> = 70MHz, f <sub>LO</sub> = 1830MHz, f <sub>RF</sub> = 1900MHz		5.7		
	f <sub>IF</sub> = 240MHz, f <sub>LO</sub> = 2210MHz, f <sub>RF</sub> = 2450MHz		4.1		

# 400MHz to 2.5GHz Upconverter Mixers

MAX2660/MAX2661/MAX2663/MAX2671/MAX2673

## AC ELECTRICAL CHARACTERISTICS (continued)

( $V_{CC} = \overline{SHDN} = +3.0V$ ,  $T_A = +25^\circ C$ , unless otherwise noted. Minimum and maximum values are guaranteed by design and characterization.)

PARAMETER	CONDITIONS	MIN	TYP	MAX	UNITS
<b>MAX2660</b> ( $P_{LO} = -5dBm$ , $P_{IFIN} = -30dBm$ , Circuit of Figure 1) (continued)					
Output 1dB Compression Point	$f_{IF} = 70MHz$ , $f_{LO} = 970MHz$ , $f_{RF} = 900MHz$		-8.4		dBm
	$f_{IF} = 70MHz$ , $f_{LO} = 1830MHz$ , $f_{RF} = 1900MHz$		-10.8		
	$f_{IF} = 240MHz$ , $f_{LO} = 2210MHz$ , $f_{RF} = 2450MHz$		-11.4		
Noise Figure (Single Sideband)	$f_{IF} = 70MHz$ , $f_{LO} = 970MHz$ , $f_{RF} = 1900MHz$		9.9		dB
	$f_{IF} = 70MHz$ , $f_{LO} = 1830MHz$ , $f_{RF} = 1900MHz$		11.8		
	$f_{IF} = 350MHz$ , $f_{LO} = 2100MHz$ , $f_{RF} = 2450MHz$		11.9		
LO Emission from RF Port	$f_{IF} = 70MHz$ , $f_{LO} = 970MHz$ , $f_{RF} = 900MHz$		-22.0		dBm
	$f_{IF} = 70MHz$ , $f_{LO} = 1830MHz$ , $f_{RF} = 1900MHz$		-20.7		
	$f_{IF} = 240MHz$ , $f_{LO} = 2210MHz$ , $f_{RF} = 2450MHz$		-22.5		
Maximum LO Input VSWR	$f = 600MHz$ to $2500MHz$ , $50\Omega$ source impedance		2.2		
Maximum Output Spurious Emissions	$f_{IF} = 70MHz$ , $f_{LO} = 1830MHz$ , $f_{RF} = 1900MHz$ (Note 1)		-70		dBm
Turn-On Time	(Note 2)		2		$\mu s$
Turn-Off Time	From $\overline{SHDN}$ low to $I_{CC} < 100\mu A$		2		$\mu s$
<b>MAX2661</b> ( $P_{LO} = -5dBm$ , $P_{IFIN} = -30dBm$ , Circuit of Figure 1)					
Conversion Gain	$f_{IF} = 45MHz$ , $f_{LO} = 445MHz$ , $f_{RF} = 400MHz$		10.2		dB
	$f_{IF} = 70MHz$ , $f_{LO} = 970MHz$ , $f_{RF} = 900MHz$		10.7		
	$f_{IF} = 70MHz$ , $f_{LO} = 1830MHz$ , $f_{RF} = 1900MHz$	7.0	8.5	10.2	
	$f_{IF} = 240MHz$ , $f_{LO} = 2210MHz$ , $f_{RF} = 2450MHz$		8.2		
Gain Variation Over Temperature	$f_{IF} = 70MHz$ , $f_{LO} = 1830MHz$ , $f_{RF} = 1900MHz$ , $T_A = -40^\circ C$ to $+85^\circ C$		$\pm 1.2$	$\pm 1.5$	dB
Output Third-Order Intercept	$f_{IF} = 70MHz$ , $f_{LO} = 970MHz$ , $f_{RF} = 900MHz$		7.1		dBm
	$f_{IF} = 70MHz$ , $f_{LO} = 1830MHz$ , $f_{RF} = 1900MHz$		6.0		
	$f_{IF} = 240MHz$ , $f_{LO} = 2210MHz$ , $f_{RF} = 2450MHz$		7.3		
Output 1dB Compression Point	$f_{IF} = 70MHz$ , $f_{LO} = 970MHz$ , $f_{RF} = 900MHz$		-6.0		dBm
	$f_{IF} = 70MHz$ , $f_{LO} = 1830MHz$ , $f_{RF} = 1900MHz$		-7.2		
	$f_{IF} = 240MHz$ , $f_{LO} = 2210MHz$ , $f_{RF} = 2450MHz$		-6.2		
Noise Figure (Single Sideband)	$f_{IF} = 70MHz$ , $f_{LO} = 970MHz$ , $f_{RF} = 900MHz$		9.8		dB
	$f_{IF} = 70MHz$ , $f_{LO} = 1830MHz$ , $f_{RF} = 1900MHz$		11.6		
	$f_{IF} = 350MHz$ , $f_{LO} = 2100MHz$ , $f_{RF} = 2450MHz$		11.8		
LO Emission from RF Port	$f_{IF} = 70MHz$ , $f_{LO} = 970MHz$ , $f_{RF} = 900MHz$		-22.9		dBm
	$f_{IF} = 70MHz$ , $f_{LO} = 1830MHz$ , $f_{RF} = 1900MHz$		-21.6		
	$f_{IF} = 240MHz$ , $f_{LO} = 2210MHz$ , $f_{RF} = 2450MHz$		-23.5		
Maximum LO Input VSWR	$f = 600MHz$ to $2500MHz$ , $50\Omega$ source impedance		2.2		
Maximum Output Spurious Emissions	$f_{IF} = 70MHz$ , $f_{LO} = 1830MHz$ , $f_{RF} = 1900MHz$ (Note 1)		-57.3		dBm
Turn-On Time	(Note 2)		2		$\mu s$
Turn-Off Time	From $\overline{SHDN}$ low to $I_{CC} < 100\mu A$		2		$\mu s$

# 400MHz to 2.5GHz Upconverter Mixers

MAX2660/MAX2661/MAX2663/MAX2671/MAX2673

## AC ELECTRICAL CHARACTERISTICS (continued)

( $V_{CC} = \overline{SHDN} = +3.0V$ ,  $T_A = +25^\circ C$ , unless otherwise noted. Minimum and maximum values are guaranteed by design and characterization.)

PARAMETER	CONDITIONS	MIN	TYP	MAX	UNITS
<b>MAX2663</b> ( $P_{LO} = -5dBm$ , $P_{IFIN} = -30dBm$ , Circuit of Figure 1)					
Conversion Gain	$f_{IF} = 45MHz$ , $f_{LO} = 445MHz$ , $f_{RF} = 400MHz$		2.0		dB
	$f_{IF} = 70MHz$ , $f_{LO} = 970MHz$ , $f_{RF} = 900MHz$		3.4		
	$f_{IF} = 70MHz$ , $f_{LO} = 1830MHz$ , $f_{RF} = 1900MHz$	-0.1	2.1	4.2	
	$f_{IF} = 240MHz$ , $f_{LO} = 2210MHz$ , $f_{RF} = 2450MHz$		1.4		
Gain Variation Over Temperature	$f_{IF} = 70MHz$ , $f_{LO} = 1830MHz$ , $f_{RF} = 1900MHz$ , $T_A = -40^\circ C$ to $+85^\circ C$		$\pm 1.1$	$\pm 1.8$	dB
Output Third-Order Intercept	$f_{IF} = 70MHz$ , $f_{LO} = 970MHz$ , $f_{RF} = 900MHz$		0.7		dBm
	$f_{IF} = 70MHz$ , $f_{LO} = 1830MHz$ , $f_{RF} = 1900MHz$		-1.4		
	$f_{IF} = 240MHz$ , $f_{LO} = 2210MHz$ , $f_{RF} = 2450MHz$		-2.8		
Output 1dB Compression Point	$f_{IF} = 70MHz$ , $f_{LO} = 970MHz$ , $f_{RF} = 900MHz$		-12.3		dBm
	$f_{IF} = 70MHz$ , $f_{LO} = 1830MHz$ , $f_{RF} = 1900MHz$		-13.3		
	$f_{IF} = 240MHz$ , $f_{LO} = 2210MHz$ , $f_{RF} = 2450MHz$		-14.3		
Noise Figure (Single Sideband)	$f_{IF} = 70MHz$ , $f_{LO} = 970MHz$ , $f_{RF} = 900MHz$		10.7		dB
	$f_{IF} = 70MHz$ , $f_{LO} = 1830MHz$ , $f_{RF} = 1900MHz$		12.2		
	$f_{IF} = 350MHz$ , $f_{LO} = 2100MHz$ , $f_{RF} = 2450MHz$		12.7		
LO Emission from RF Port	$f_{IF} = 70MHz$ , $f_{LO} = 970MHz$ , $f_{RF} = 900MHz$		-22.7		dBm
	$f_{IF} = 70MHz$ , $f_{LO} = 1830MHz$ , $f_{RF} = 1900MHz$		-21.0		
	$f_{IF} = 240MHz$ , $f_{LO} = 2210MHz$ , $f_{RF} = 2450MHz$		-21.6		
Maximum LO Input VSWR	$f = 600MHz$ to $2500MHz$ , $50\Omega$ source impedance		2.1		
Maximum Output Spurious Emissions	$f_{IF} = 70MHz$ , $f_{LO} = 1830MHz$ , $f_{RF} = 1900MHz$ (Note 1)		-67		dBm
Turn-On Time	(Note 2)		2		$\mu s$
Turn-Off Time	From $\overline{SHDN}$ low to $I_{CC} < 100\mu A$		2		$\mu s$
<b>MAX2671</b> ( $P_{LO} = -10dBm$ , $P_{IFIN} = -30dBm$ , Circuit of Figure 1)					
Conversion Gain	$f_{IF} = 45MHz$ , $f_{LO} = 445MHz$ , $f_{RF} = 400MHz$		10.0		dB
	$f_{IF} = 70MHz$ , $f_{LO} = 970MHz$ , $f_{RF} = 900MHz$		11.2		
	$f_{IF} = 70MHz$ , $f_{LO} = 1830MHz$ , $f_{RF} = 1900MHz$	6.7	9.3	11.9	
	$f_{IF} = 240MHz$ , $f_{LO} = 2210MHz$ , $f_{RF} = 2450MHz$		8.9		
Gain Variation Over Temperature	$f_{IF} = 70MHz$ , $f_{LO} = 1830MHz$ , $f_{RF} = 1900MHz$ , $T_A = -40^\circ C$ to $+85^\circ C$		$\pm 1.1$	$\pm 1.3$	dB
Output Third-Order Intercept	$f_{IF} = 70MHz$ , $f_{LO} = 970MHz$ , $f_{RF} = 900MHz$		9.6		dBm
	$f_{IF} = 70MHz$ , $f_{LO} = 1830MHz$ , $f_{RF} = 1900MHz$		8.3		
	$f_{IF} = 240MHz$ , $f_{LO} = 2210MHz$ , $f_{RF} = 2450MHz$		9.4		
Output 1dB Compression Point	$f_{IF} = 70MHz$ , $f_{LO} = 970MHz$ , $f_{RF} = 900MHz$		-5.5		dBm
	$f_{IF} = 70MHz$ , $f_{LO} = 1830MHz$ , $f_{RF} = 1900MHz$		-6.4		
	$f_{IF} = 240MHz$ , $f_{LO} = 2210MHz$ , $f_{RF} = 2450MHz$		-6.0		

# 400MHz to 2.5GHz Upconverter Mixers

MAX2660/MAX2661/MAX2663/MAX2671/MAX2673

## AC ELECTRICAL CHARACTERISTICS (continued)

( $V_{CC} = \overline{SHDN} = +3.0V$ ,  $T_A = +25^\circ C$ , unless otherwise noted. Minimum and maximum values are guaranteed by design and characterization.)

PARAMETER	CONDITIONS	MIN	TYP	MAX	UNITS
<b>MAX2671</b> ( $P_{LO} = -10dBm$ , $P_{IFIN} = -30dBm$ , Circuit of Figure 1) (continued)					
Noise Figure (Single Sideband)	$f_{IF} = 70MHz$ , $f_{LO} = 970MHz$ , $f_{RF} = 900MHz$		9.3		dB
	$f_{IF} = 70MHz$ , $f_{LO} = 1830MHz$ , $f_{RF} = 1900MHz$		10.7		
	$f_{IF} = 350MHz$ , $f_{LO} = 2100MHz$ , $f_{RF} = 2450MHz$		11.3		
LO Emission from RF Port	$f_{IF} = 70MHz$ , $f_{LO} = 970MHz$ , $f_{RF} = 900MHz$		-40.3		dBm
	$f_{IF} = 70MHz$ , $f_{LO} = 1830MHz$ , $f_{RF} = 1900MHz$		-35.7		
	$f_{IF} = 240MHz$ , $f_{LO} = 2210MHz$ , $f_{RF} = 2450MHz$		-36.8		
Maximum LO Input VSWR	$f = 600MHz$ to $2500MHz$ , $50\Omega$ source impedance		2.2		dBm
Maximum Output Spurious Emissions	$f_{IF} = 70MHz$ , $f_{LO} = 1830MHz$ , $f_{RF} = 1900MHz$ (Note 1)		-56		dBm
Turn-On Time	(Note 2)		2		$\mu s$
Turn-Off Time	From $\overline{SHDN}$ low to $I_{CC} < 100\mu A$		2		$\mu s$
<b>MAX2673</b> ( $P_{LO} = -10dBm$ , $P_{IFIN} = -30dBm$ , Circuit of Figure 2)					
Conversion Gain	$f_{IF} = 45MHz$ , $f_{LO} = 445MHz$ , $f_{RF} = 400MHz$		12.6		dB
	$f_{IF} = 70MHz$ , $f_{LO} = 970MHz$ , $f_{RF} = 900MHz$		12.3		
	$f_{IF} = 70MHz$ , $f_{LO} = 1830MHz$ , $f_{RF} = 1900MHz$	7.8	9.2	10.6	
	$f_{IF} = 240MHz$ , $f_{LO} = 2210MHz$ , $f_{RF} = 2450MHz$		8.6		
Gain Variation Over Temperature	$f_{IF} = 70MHz$ , $f_{LO} = 1830MHz$ , $f_{RF} = 1900MHz$ , $T_A = -40^\circ C$ to $+85^\circ C$		$\pm 1.0$	$\pm 1.4$	dB
Output Third-Order Intercept	$f_{IF} = 70MHz$ , $f_{LO} = 970MHz$ , $f_{RF} = 900MHz$		7.6		dBm
	$f_{IF} = 70MHz$ , $f_{LO} = 1830MHz$ , $f_{RF} = 1900MHz$		5.9		
	$f_{IF} = 240MHz$ , $f_{LO} = 2210MHz$ , $f_{RF} = 2450MHz$		4.5		
Output 1dB Compression Point	$f_{IF} = 70MHz$ , $f_{LO} = 970MHz$ , $f_{RF} = 900MHz$		-2.1		dBm
	$f_{IF} = 70MHz$ , $f_{LO} = 1830MHz$ , $f_{RF} = 1900MHz$		-5.9		
	$f_{IF} = 240MHz$ , $f_{LO} = 2210MHz$ , $f_{RF} = 2450MHz$		-8.3		
Noise Figure (Single Sideband)	$f_{IF} = 70MHz$ , $f_{LO} = 970MHz$ , $f_{RF} = 900MHz$		9.7		dB
	$f_{IF} = 70MHz$ , $f_{LO} = 1830MHz$ , $f_{RF} = 1900MHz$		10.1		
	$f_{IF} = 350MHz$ , $f_{LO} = 2100MHz$ , $f_{RF} = 2450MHz$		10.4		
LO Emission from RF Port	$f_{IF} = 70MHz$ , $f_{LO} = 970MHz$ , $f_{RF} = 900MHz$		-29.4		dBm
	$f_{IF} = 70MHz$ , $f_{LO} = 1830MHz$ , $f_{RF} = 1900MHz$		-27.9		
	$f_{IF} = 240MHz$ , $f_{LO} = 2210MHz$ , $f_{RF} = 2450MHz$		-26.6		
Maximum LO Input VSWR	$f = 600MHz$ to $2500MHz$ , $50\Omega$ source impedance		2.2		
Maximum Output Spurious Emissions	$f_{IF} = 70MHz$ , $f_{LO} = 1830MHz$ , $f_{RF} = 1900MHz$ (Note 1)		-59.7		dBm
Turn-On Time	(Note 2)		2		$\mu s$
Turn-Off Time	From $\overline{SHDN}$ low to $I_{CC} < 100\mu A$		2		$\mu s$

**Note 1:** Excluding LO harmonics and products of LO harmonics by first-order IF.

**Note 2:** From  $\overline{SHDN}$  high to output within 1dB of final output power,  $f_{RF} = 900MHz$ ,  $f_{IF} = 70MHz$ .

# 400MHz to 2.5GHz Upconverter Mixers

## Typical Operating Characteristics

( $V_{CC} = \overline{SHDN} = +3.0V$ , Typical Operating Circuits,  $P_{LO} = -5dBm$  (MAX2660/MAX2661/MAX2663),  $P_{LO} = -10dBm$  (MAX2671/MAX2673),  $P_{IFIN} = -30dBm$ ,  $T_A = +25^\circ C$ , unless otherwise noted.)

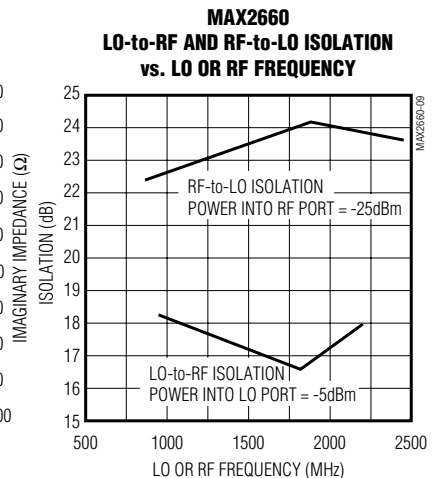
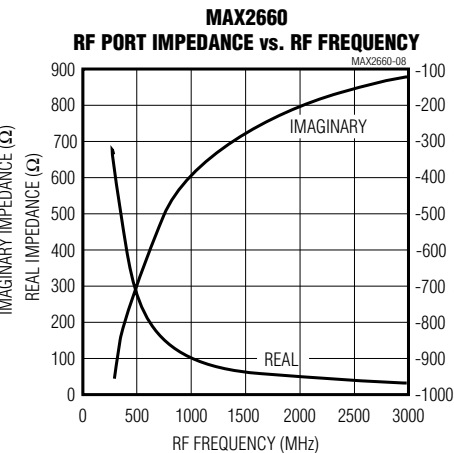
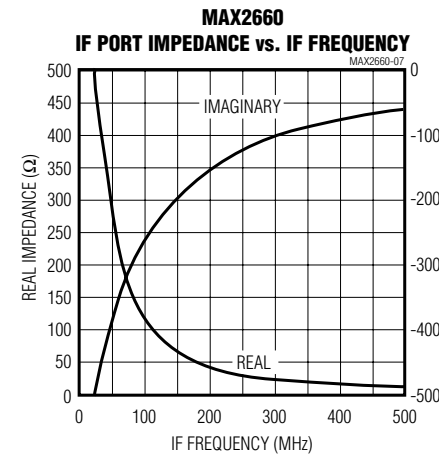
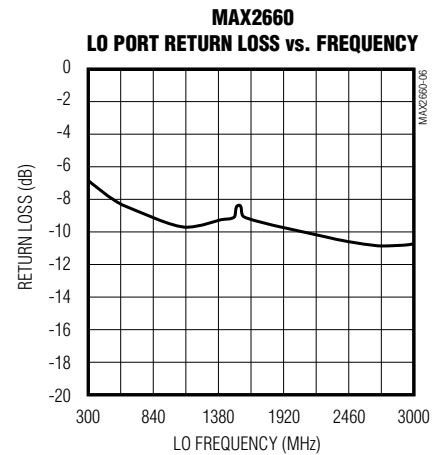
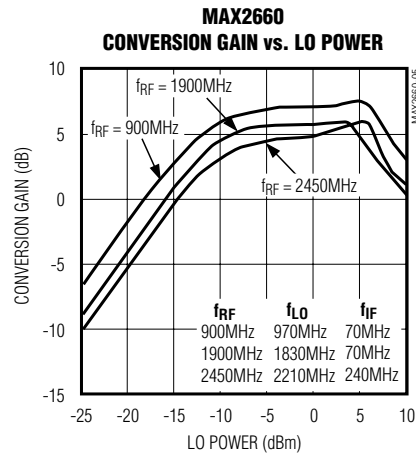
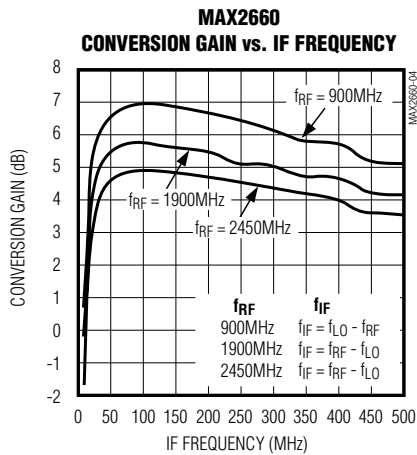
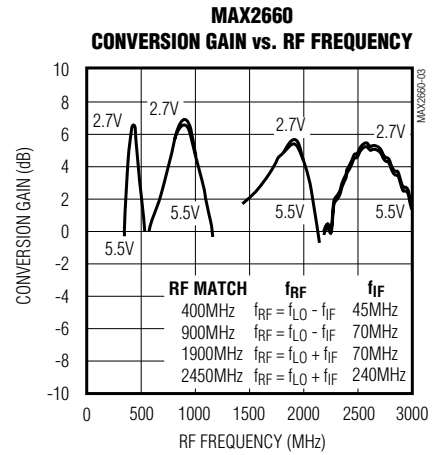
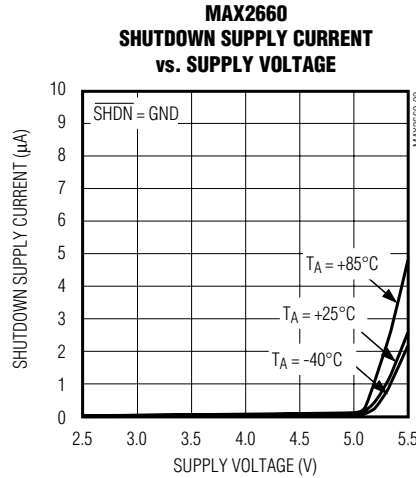
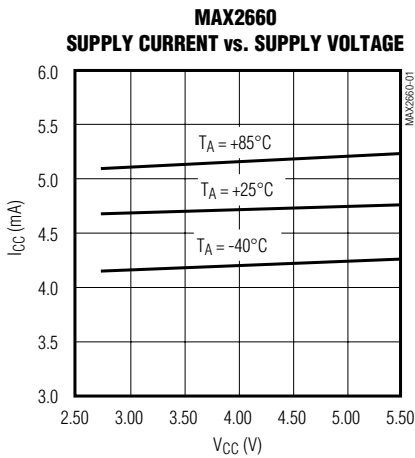

# 400MHz to 2.5GHz Upconverter Mixers

## Typical Operating Characteristics (continued)

( $V_{CC} = \overline{\text{SHDN}} = +3.0\text{V}$ , Typical Operating Circuits,  $P_{LO} = -5\text{dBm}$  (MAX2660/MAX2661/MAX2663),  $P_{LO} = -10\text{dBm}$  (MAX2671/MAX2673),  $P_{IFIN} = -30\text{dBm}$ ,  $T_A = +25^\circ\text{C}$ , unless otherwise noted.)

MAX2660/MAX2661/MAX2663/MAX2671/MAX2673

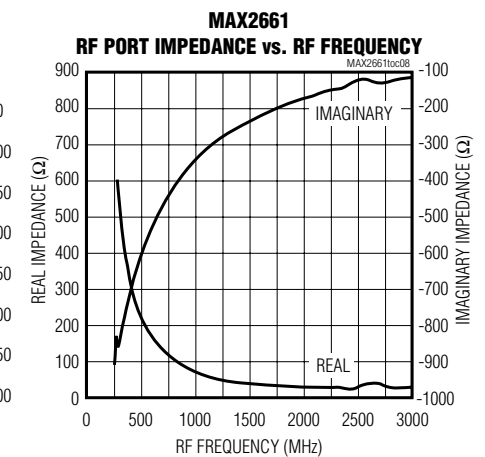
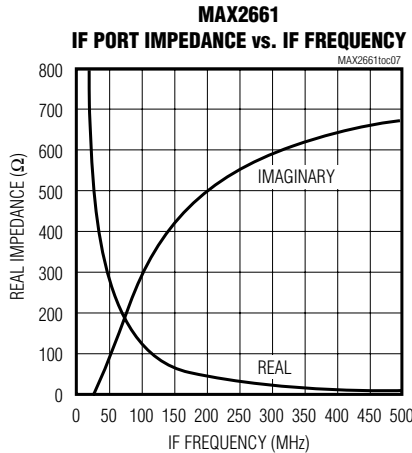
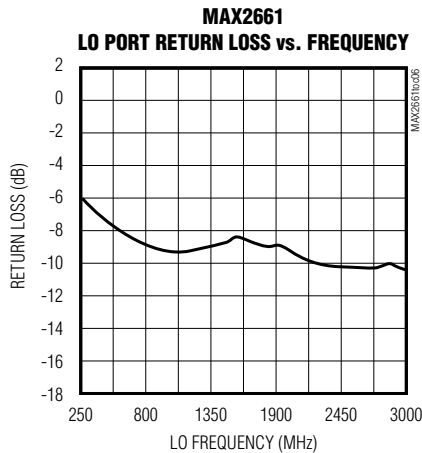
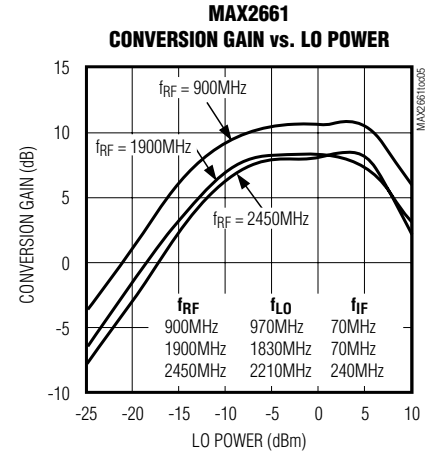
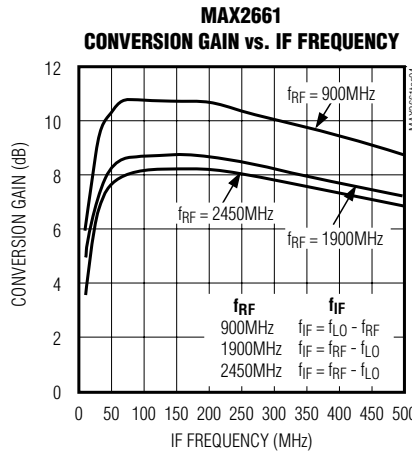
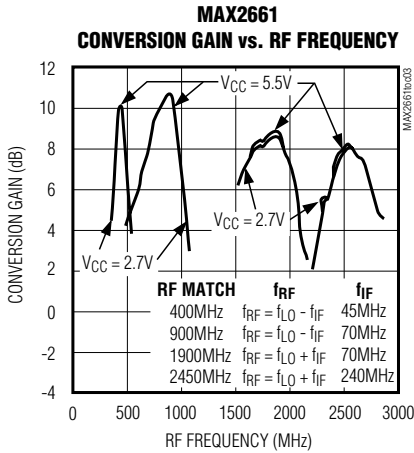
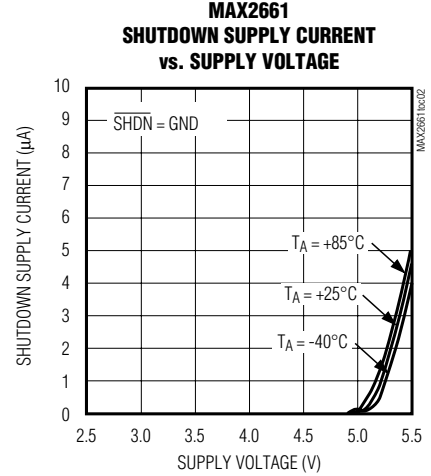

# 400MHz to 2.5GHz Upconverter Mixers

## Typical Operating Characteristics (continued)

( $V_{CC} = \overline{SHDN} = +3.0V$ , Typical Operating Circuits,  $P_{LO} = -5dBm$  (MAX2660/MAX2661/MAX2663),  $P_{LO} = -10dBm$  (MAX2671/MAX2673),  $P_{IFIN} = -30dBm$ ,  $T_A = +25^\circ C$ , unless otherwise noted.)

**MAX2661**  
**LO-to-RF AND RF-TO-LO ISOLATION**  
**vs. LO OR RF FREQUENCY**

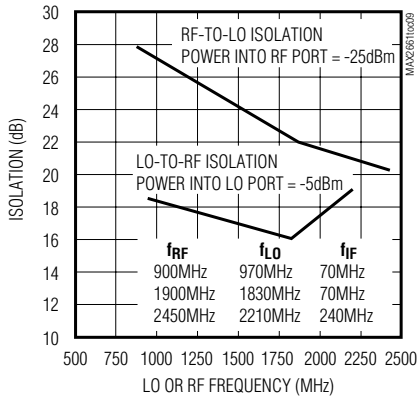

**MAX2661**  
**CONVERSION GAIN AND OUTPUT**  
**POWER vs. IF INPUT POWER**

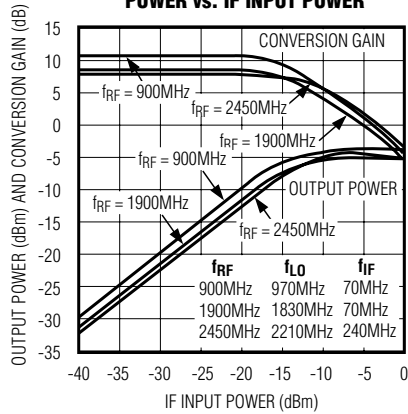

**MAX2663**  
**SUPPLY CURRENT vs. SUPPLY VOLTAGE**

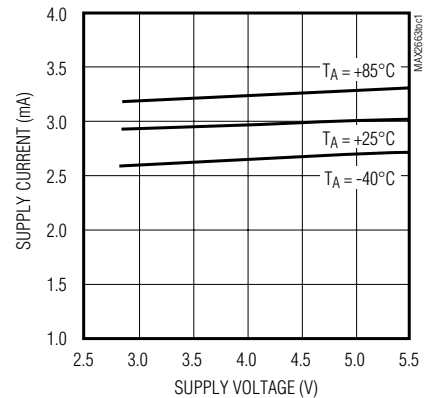

**MAX2663**  
**SHUTDOWN SUPPLY CURRENT**  
**vs. SUPPLY VOLTAGE**

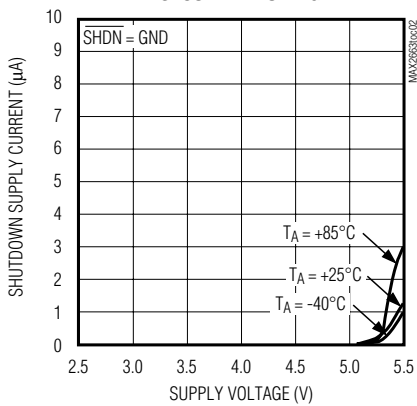

**MAX2663**  
**CONVERSION GAIN vs. RF FREQUENCY**

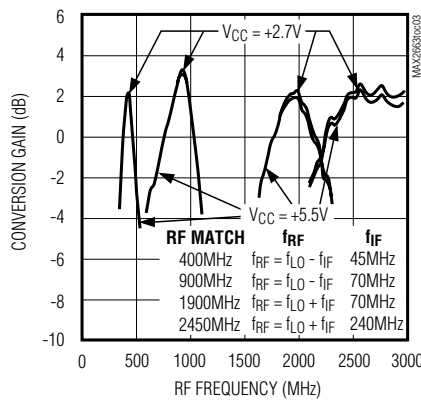

**MAX2663**  
**CONVERSION GAIN vs. IF FREQUENCY**

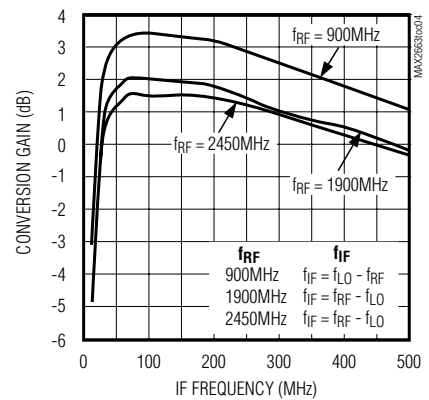

**MAX2663**  
**CONVERSION GAIN vs. LO POWER**

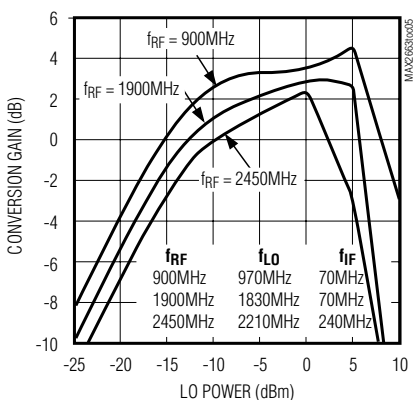

**MAX2663**  
**LO PORT RETURN LOSS vs. LO FREQUENCY**

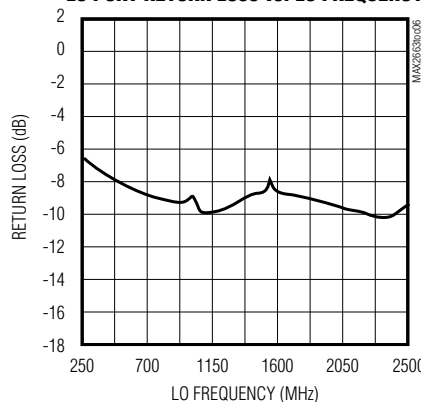

**MAX2663**  
**IF PORT IMPEDANCE vs. IF FREQUENCY**

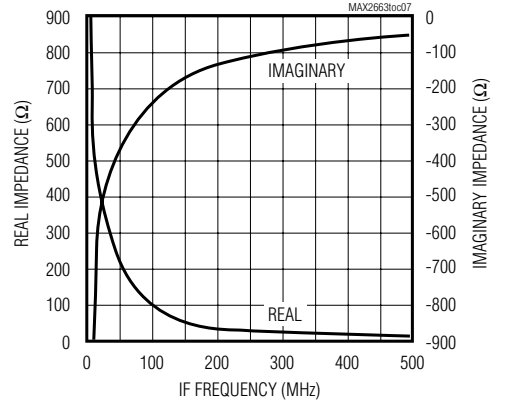



# 400MHz to 2.5GHz Upconverter Mixers

## Typical Operating Characteristics (continued)

( $V_{CC} = \overline{SHDN} = +3.0V$ , Typical Operating Circuits,  $P_{LO} = -5dBm$  (MAX2660/MAX2661/MAX2663),  $P_{LO} = -10dBm$  (MAX2671/MAX2673),  $P_{IFIN} = -30dBm$ ,  $T_A = +25^\circ C$ , unless otherwise noted.)

MAX2660/MAX2661/MAX2663/MAX2671/MAX2673

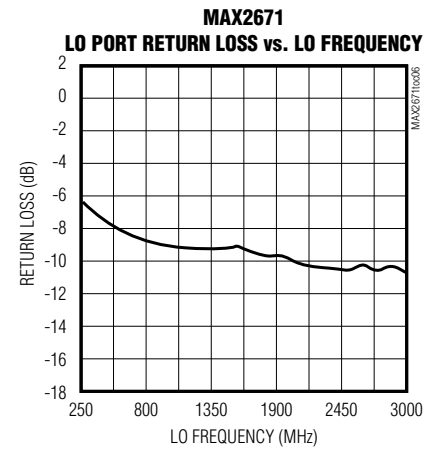
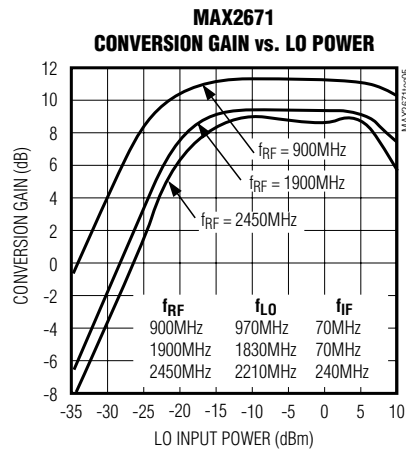
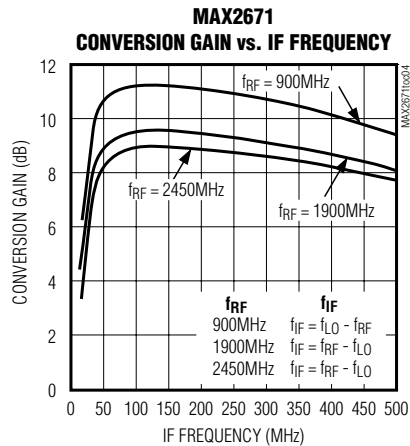
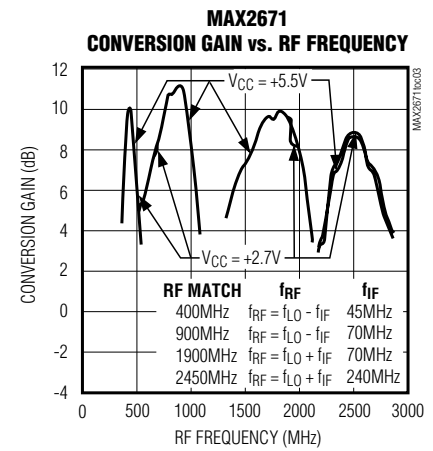
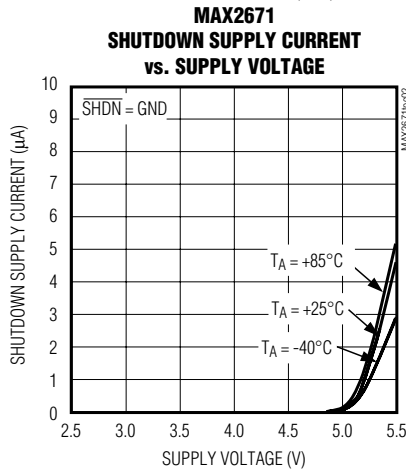
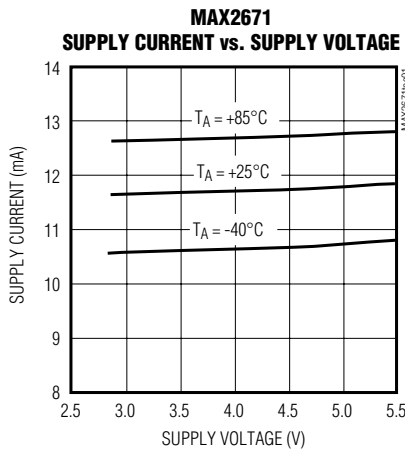
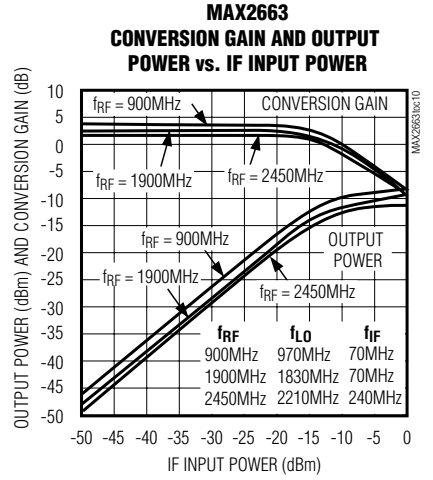
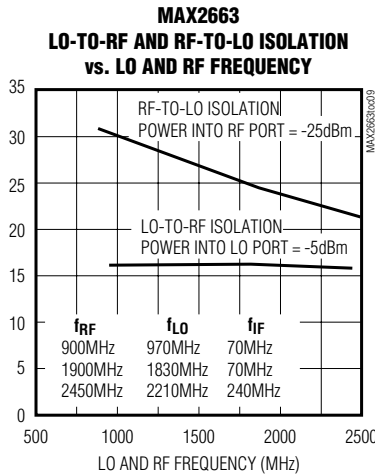
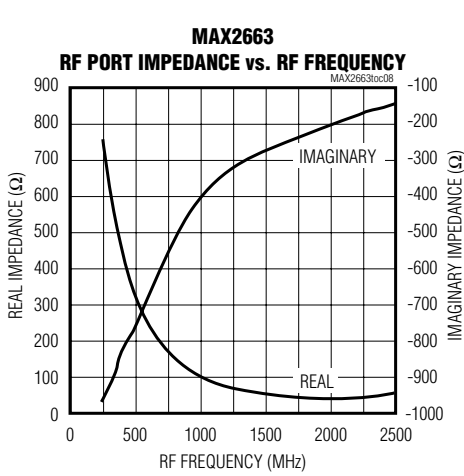

# 400MHz to 2.5GHz Upconverter Mixers

## Typical Operating Characteristics (continued)

( $V_{CC} = \overline{\text{SHDN}} = +3.0\text{V}$ , Typical Operating Circuits,  $P_{LO} = -5\text{dBm}$  (MAX2660/MAX2661/MAX2663),  $P_{LO} = -10\text{dBm}$  (MAX2671/MAX2673),  $P_{IFIN} = -30\text{dBm}$ ,  $T_A = +25^\circ\text{C}$ , unless otherwise noted.)

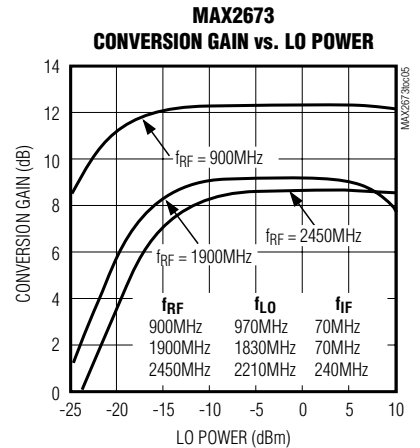
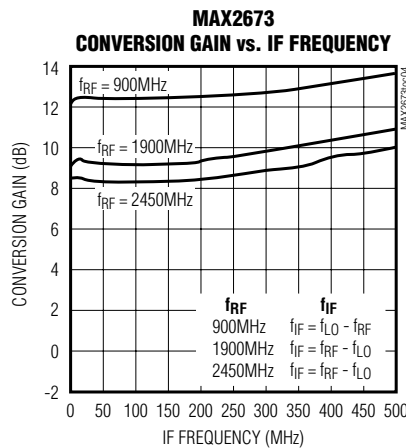
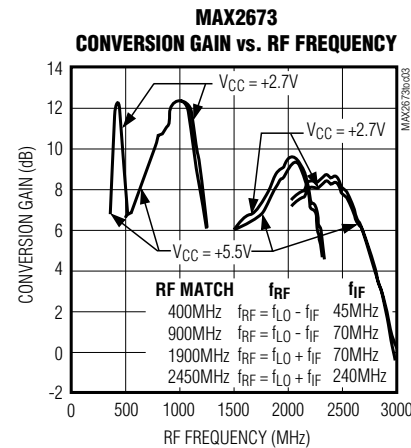
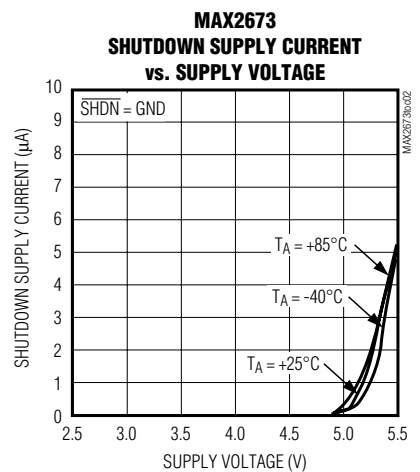
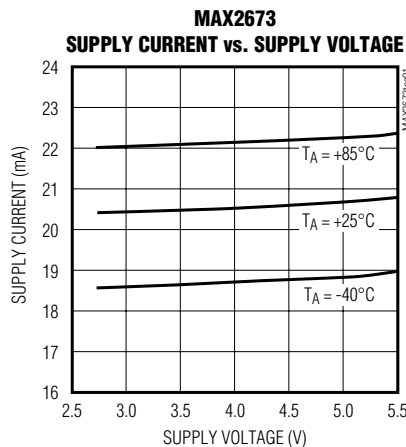
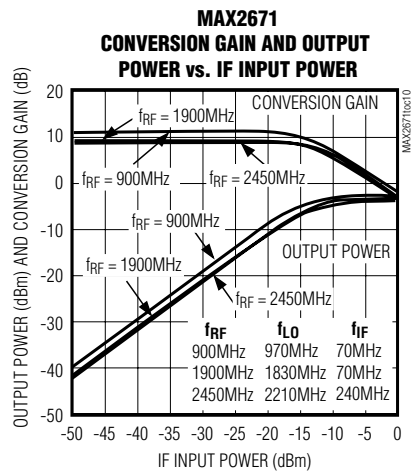
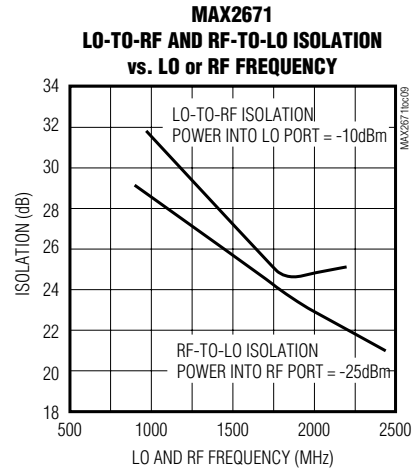
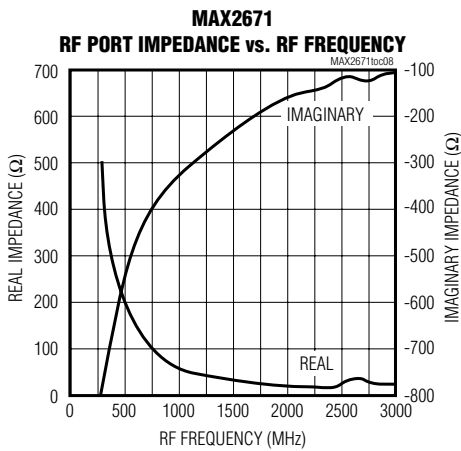
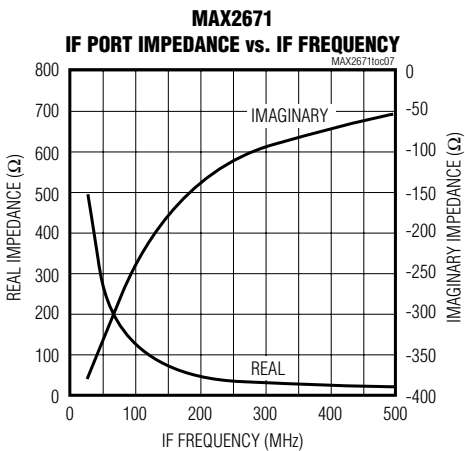

# 400MHz to 2.5GHz Upconverter Mixers

## Typical Operating Characteristics (continued)

( $V_{CC} = \overline{SHDN} = +3.0V$ , Typical Operating Circuits,  $P_{LO} = -5dBm$  (MAX2660/MAX2661/MAX2663),  $P_{LO} = -10dBm$  (MAX2671/MAX2673),  $P_{IFIN} = -30dBm$ ,  $T_A = +25^\circ C$ , unless otherwise noted.)

MAX2660/MAX2661/MAX2663/MAX2671/MAX2673

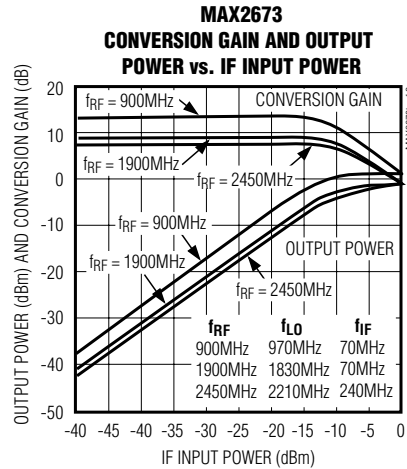
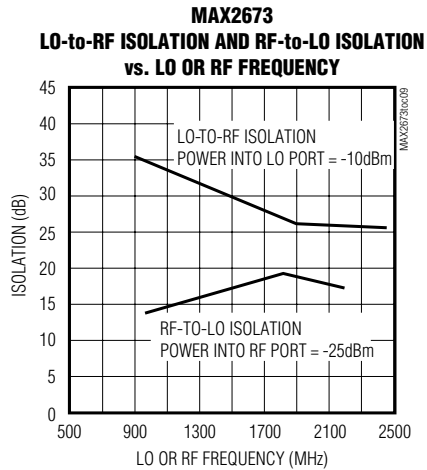
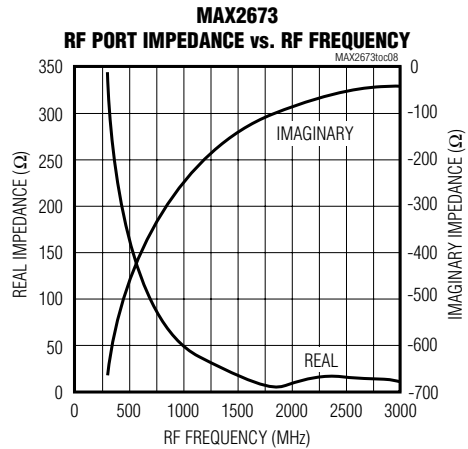
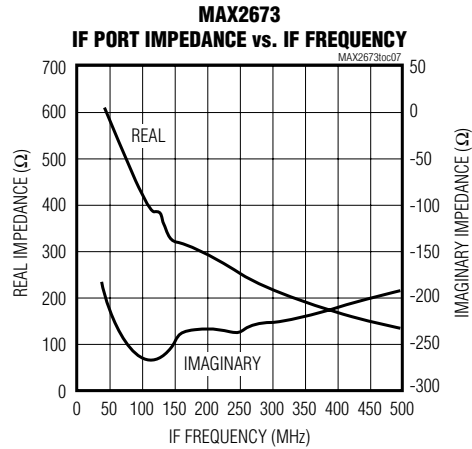
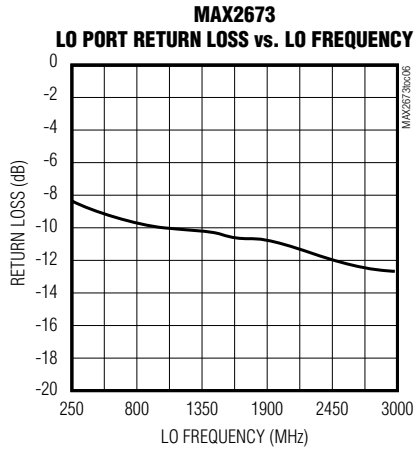

# 400MHz to 2.5GHz Upconverter Mixers

## Pin Description

PIN		NAME	FUNCTION
MAX2660 MAX2661 MAX2663 MAX2671	MAX2673		
1	1	LO	Local-Oscillator Input. Apply a local-oscillator signal with an amplitude of -10dBm to +5dBm for the MAX2671/MAX2673 or -5dBm to +2dBm for the MAX2660/ MAX2661/ MAX2663. AC-couple to the oscillator with a DC blocking capacitor. Nominal DC voltage is $V_{CC} - 0.4V$ to $V_{CC} - 1.0V$ .
2	2, 6	GND	Mixer Ground. Connect to the ground plane with a low-inductance connection.
3	7, 8	IFIN	Intermediate Frequency Input. AC-couple to the input signal with a DC blocking capacitor. Nominal DC voltage is 1.37V.
4	5	RFOUT	Radio Frequency Output. Open-collector output requires an inductor to $V_{CC}$ that is part of an impedance-matching network. AC-couple to this pin using a blocking capacitor that can be part of the impedance-matching network. See <i>Applications Information</i> for details on impedance matching.
5	4	$V_{CC}$	Voltage Supply Rail, +2.7V to +5.5V. Bypass with a capacitor to the ground plane. Capacitor value depends on desired operating frequency.
6	3	$\overline{SHDN}$	Active-Low Shutdown Pin. Drive low to deactivate all part functions and reduce the supply current to less than 1 $\mu$ A. For normal operation, drive high or connect to $V_{CC}$ .

MAX2660/MAX2661/MAX2663/MAX2671/MAX2673

# 400MHz to 2.5GHz Upconverter Mixers

MAX2660/MAX2661/MAX2663/MAX2671/MAX2673

## Detailed Description

The MAX2660/MAX2661/MAX2663/MAX2671/MAX2673 are 2.5GHz double-balanced upconverter mixers designed to provide optimum linearity performance for a specified supply current. These upconverter mixers use single-ended RF, LO, and IF port connections, except for the MAX2673, which uses a differential IF port. An on-chip bias cell provides a low-power shut-down feature. See the *Selector Guide* for device features and comparison.

## Applications Information

### Local-Oscillator (LO) Input

The LO input is a single-ended broadband port with a return loss of better than 8dB from 600MHz to 2.5GHz. The LO signal is mixed with the input IF signal, and the resulting upconverted output appears on the RFOUT pin. AC-couple the LO pin with a capacitor having less than  $3\Omega$  reactance at the LO frequency. The MAX2671/MAX2673 include an internal LO buffer and require an LO signal ranging from -10dBm to +5dBm, while the MAX2660/MAX2661/MAX2663 require an LO signal ranging from -5dBm to +2dBm.

### IF Input

The MAX2660/MAX2661/MAX2663/MAX2671 have a single-ended IF input port, while the MAX2673 has a differential IF input port for high-performance interface-to-differential IF filters. AC-couple the IF pin(s) with a capacitor. The typical IF input frequency range is 40MHz to 500MHz. For further information, see the IF Port Impedance vs. IF Frequency graph in the *Typical Operating Characteristics*.

### RF Output

The RF output frequency range extends from 400MHz to 2.5GHz. RFOUT is a high-impedance, open-collector output that requires an external inductor to VCC for proper biasing. For optimum performance, implement an impedance-matching network. The configuration and values for the matching network depend on the frequency, performance, and desired output impedance. For assistance in choosing components for optimal performance, see Table 1 as well as the RF Output Impedance vs. RF Frequency graph in the *Typical Operating Characteristics*.

### Power Supply and $\overline{\text{SHDN}}$ Bypassing

Proper attention to supply bypassing is essential for a high-frequency RF circuit. Bypass VCC with a 10 $\mu$ F capacitor in parallel with an RF capacitor (Table 2). Use separate vias to the ground plane for each of the bypass capacitors and minimize trace length to reduce inductance. Use separate vias to the ground plane for each ground pin. Use low-inductance ground connections.

Decouple  $\overline{\text{SHDN}}$  with a 100pF capacitor to ground to minimize noise on the internal bias cell. Use a series resistor (typically 100 $\Omega$ ) to reduce coupling of high-frequency signals into the  $\overline{\text{SHDN}}$  pin.

### Layout Issues

A well-designed PC board is an essential part of an RF circuit. For best performance, pay attention to power-supply issues as well as to the layout of the RFOUT matching network.

### Power-Supply Layout

To minimize coupling between different sections of the IC, the ideal power-supply layout is a star configuration with a large decoupling capacitor at a central VCC node. The VCC traces branch out from this central node, each going to a separate VCC node in the PC board. At the end of each trace is a bypass capacitor that has low ESR at the RF frequency of operation. This arrangement provides local decoupling at each VCC pin. At high frequencies, any signal leaking out of one supply pin sees a relatively high impedance (formed by the VCC trace inductance) to the central VCC node, and an even higher impedance to any other supply pin, as well as a low impedance to ground through the bypass capacitor.

### Impedance-Matching Network Layout

The RFOUT matching network is very sensitive to layout-related parasitics. To minimize parasitic inductance, keep all traces short and place components as close as possible to the chip. To minimize parasitic capacitance, use cutouts in the ground plane (and any other plane) below the matching network components.

# 400MHz to 2.5GHz Upconverter Mixers

**Table 1. RF Output Impedance**

PART	RF OUTPUT IMPEDANCE ( $\Omega$ )			
	AT 400MHz	AT 900MHz	AT 1900MHz	AT 2450MHz
MAX2660	480-j732	126-j459	65-j190	46-j124
MAX2661	357-j649	92-j375	54-j152	38-j99
MAX2663	485-j718	130-j453	65-j188	45-j123
MAX2671	333-j613	82-j360	46-j150	31-j95
MAX2673	220-j530	70-j290	35-j110	32-j70

**Table 2. Typical Operating Circuit (External Component Values)**

COMPONENT	COMPONENT VALUE AT A GIVEN FREQUENCY (MHz)															
	MAX2660				MAX2661/MAX2671				MAX2663				MAX2673			
	AT 400	AT 900	AT 1900	AT 2450	AT 400	AT 900	AT 1900	AT 2450	AT 400	AT 900	AT 1900	AT 2450	AT 400	AT 900	AT 1900	AT 2450
L1 (nH)	Short	33	8.2	3.3	Short	33	8.2	3.3	Short	33	8.2	3.3	Short	27	5.6	3.9
L2 (nH)	39	18	2.7	2.2	39	18	2.7	1.8	39	18	1.8	1.8	39	18	4.7	6.8
C3 (pF)	470	47	47	47	470	47	47	47	470	47	47	47	3.3	220	10	15
C4 (pF)	3.3	220	220	15	3.3	220	100	220	3.3	220	100	220	6.8	1.5	1.5	1
C5 (pF)	6.8	1	1.5	Open	6.8	1	1.5	Open	6.8	1.8	1.8	Open	470	47	47	47
C6 (pF)	470	47	47	15	470	47	100	47	470	47	100	47	470	100	100	100

## Functional Diagram

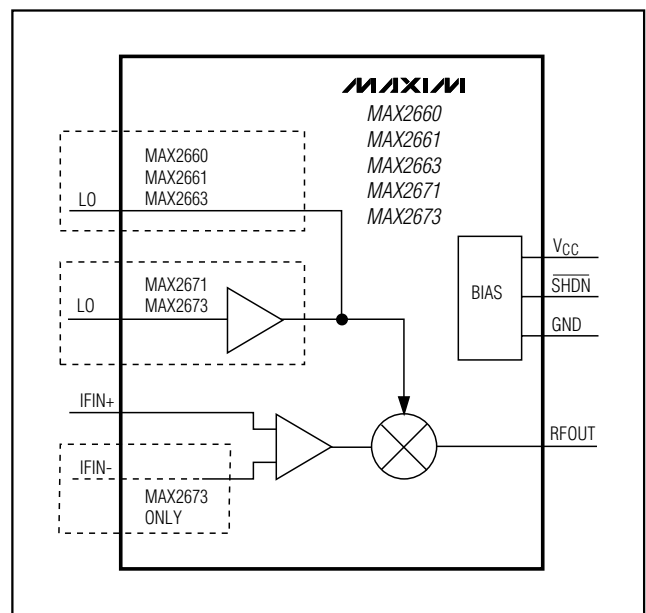

# 400MHz to 2.5GHz Upconverter Mixers

## Typical Operating Circuits

MAX2660/MAX2661/MAX2663/MAX2671/MAX2673

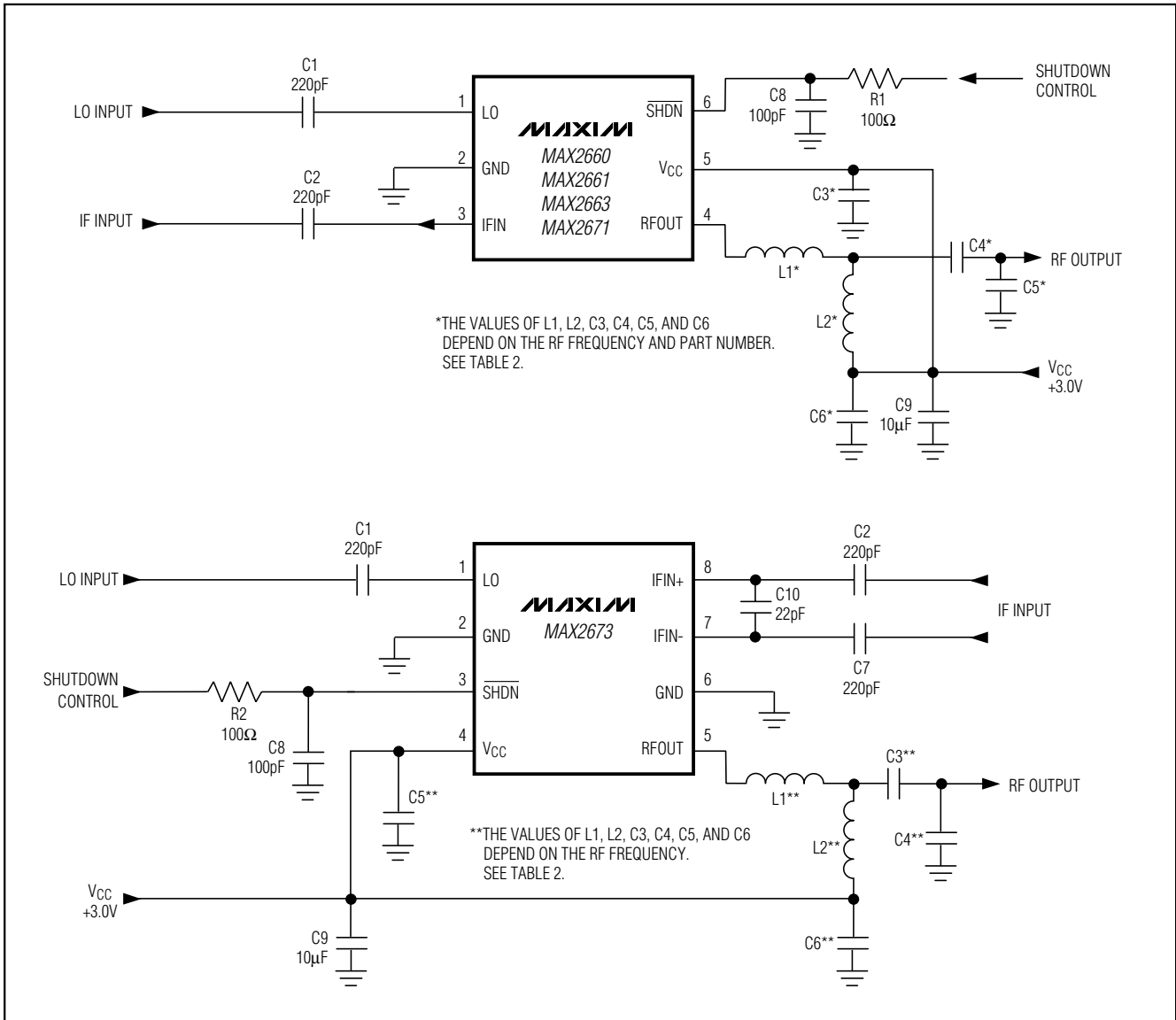

# 400MHz to 2.5GHz Upconverter Mixers

## Package Information

SYMBOL	MIN	MAX
A	0.90	1.45
A1	0.00	0.15
A2	0.90	1.30
b	0.35	0.50
C	0.08	0.20
D	2.80	3.00
E	2.60	3.00
E1	1.50	1.75
L	0.35	0.55
e	0.95	REF
a	0*	10*

**NOTE:**

- ALL DIMENSIONS ARE IN MILLIMETERS.
- FOOT LENGTH MEASURED AT INTERCEPT POINT BETWEEN DATUM A & LEAD SURFACE.
- PACKAGE OUTLINE EXCLUSIVE OF MOLD FLASH & METAL BURR.
- PACKAGE OUTLINE INCLUSIVE OF SOLDER PLATING.
- PIN 1 IS LOWER LEFT PIN WHEN READING TOP MARK FROM LEFT TO RIGHT. (SEE EXAMPLE TOP MARK)
- PIN 1 I.D. DOT IS 0.3 MM Ø MIN. LOCATED ABOVE PIN 1.

**MAXIM**  
 PROPRIETARY INFORMATION  
 TITLE: PACKAGE OUTLINE, SOT23, 6L  
 APPROVAL: \_\_\_\_\_ DOCUMENT CONTROL NO: 21-0058 REV: D 1/1

	INCHES		MILLIMETERS		JEDEC			
	MIN	MAX	MIN	MAX	MIN	MAX	MIN	MAX
A	0.037	0.043	0.94	1.10	---	0.043	---	1.10
A1	0.002	0.006	0.05	0.15	0.002	0.006	0.05	0.15
B	0.010	0.014	0.25	0.36	0.010	0.016	0.25	0.40
C	0.005	0.007	0.13	0.18	0.005	0.009	0.13	0.23
D	0.116	0.120	2.95	3.05	0.114	0.122	2.9	3.1
e	0.0256	BSC	0.65	BSC	0.0256	BSC	0.64	BSC
E	0.116	0.120	2.95	3.05	0.114	0.122	2.9	3.1
H	0.188	0.198	4.78	5.03	0.193	BSC	4.9	BSC
L	0.016	0.026	0.41	0.66	0.016	0.027	0.40	0.70
α	0*	6*	0*	6*	0*	6*	0*	6*
*X	0.087	0.099	2.210	2.515				
*Y	0.062	0.074	1.575	1.880				

**NOTES:**

- D & E DO NOT INCLUDE MOLD FLASH.
- MOLD FLASH OR PROTRUSIONS NOT TO EXCEED .15 MM (.006").
- CONTROLLING DIMENSION: MILLIMETERS.
- MEETS JEDEC MO-187.
- DIMENSIONS X & Y APPLY TO EXPOSED PAD VERSIONS ONLY.
- EXPOSED PAD FLUSH WITH BOTTOM OF PACKAGE WITHIN .002".

**MAXIM**  
 PROPRIETARY INFORMATION  
 TITLE: PACKAGE OUTLINE, 8L uMAX  
 APPROVAL: \_\_\_\_\_ DOCUMENT CONTROL NO: 21-0036 REV: G 1/1



## Данный компонент на территории Российской Федерации

### Вы можете приобрести в компании MosChip.

Для оперативного оформления запроса Вам необходимо перейти по данной ссылке:

<http://moschip.ru/get-element>

Вы можете разместить у нас заказ для любого Вашего проекта, будь то серийное производство или разработка единичного прибора.

В нашем ассортименте представлены ведущие мировые производители активных и пассивных электронных компонентов.

Нашей специализацией является поставка электронной компонентной базы двойного назначения, продукции таких производителей как XILINX, Intel (ex.ALTERA), Vicor, Microchip, Texas Instruments, Analog Devices, Mini-Circuits, Amphenol, Glenair.

Сотрудничество с глобальными дистрибьюторами электронных компонентов, предоставляет возможность заказывать и получать с международных складов практически любой перечень компонентов в оптимальные для Вас сроки.

На всех этапах разработки и производства наши партнеры могут получить квалифицированную поддержку опытных инженеров.

Система менеджмента качества компании отвечает требованиям в соответствии с ГОСТ Р ИСО 9001, ГОСТ РВ 0015-002 и ЭС РД 009

### Офис по работе с юридическими лицами:

105318, г.Москва, ул.Щербаковская д.3, офис 1107, 1118, ДЦ «Щербаковский»

Телефон: +7 495 668-12-70 (многоканальный)

Факс: +7 495 668-12-70 (доб.304)

E-mail: [info@moschip.ru](mailto:info@moschip.ru)

Skype отдела продаж:

moschip.ru

moschip.ru\_4

moschip.ru\_6

moschip.ru\_9