

FEATURES

- PROFIBUS IEC 61158-2 Compliant
- Protected from Overvoltage Line Faults to ±60V
- ±52kV ESD Interface Pins, ±15kV All Other Pins
- ±2kV (Level 4) IEC61000-4-4 Fast Transient Burst
- ±25V Working Common Mode Range
- 20Mbps Maximum Baud Rate
- 1.65V to 5.5V Logic Supply Pin for Flexible Digital Interfacing (LTC2877)
- 5V Supply Can Operate Down to 3V for Low Power, Low Swing Applications
- Fully Balanced Differential Receiver Thresholds with 240mV Hysteresis for Superior Noise Tolerance and Low Duty Cycle Distortion
- Receiver Failsafe for Open, Shorted and Terminated Conditions
- Wide Operating Temperature Range: -40°C to 125°C
- Available in Small DFN and MSOP Packages

APPLICATIONS

- PROFIBUS-DP
- Industrial Communication Networks
- RS485 and RS422 Systems
- 3V Low Voltage Differential Signaling

DESCRIPTION

The **LTC[®]2876** and LTC2877 are PROFIBUS RS485 transceivers designed to meet the test specifications for PROFIBUS-DP masters and PROFIBUS-DP slaves, fully compatible with IEC 61158-2, type 3: medium attachment unit (MAU). With operation up to 20Mbps, the LTC2876/LTC2877 supports all PROFIBUS data rates up to 12Mbps.

The LTC2876 and LTC2877 are exceptionally robust, tolerating ±60V faults on the bus pins and protected to ±52kV ESD. These devices are suitable for harsh environments or where 24V power might be inadvertently connected. Extended ±25V input common mode range and full fail-safe operation improve data communication reliability in noisy systems.

The LTC2876 and LTC2877 meet PROFIBUS and RS485 specifications with a supply voltage of 4.5V to 5.5V but can operate down to 3V with reduced supply current.

Product Selection Guide

PART NUMBER	LOGIC SUPPLY PIN	PACKAGE
LTC2876	NO	DFN-8, MSOP-8
LTC2877	YES	DFN-10, MSOP-10

LT, LT, LTC, LTM, Linear Technology and the Linear logo are registered trademarks of Linear Technology Corporation. All other trademarks are the property of their respective owners.

TYPICAL APPLICATION



Eye Diagram of 12Mbps Signal at the Near and Far End of a 100m PROFIBUS Cable Driven by the LTC2877 Using 2⁸-1 PRBS Pattern

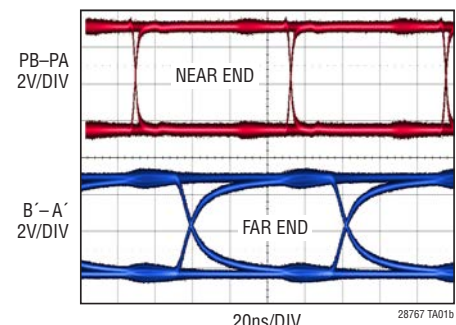

28767fa

LTC2876/LTC2877

ABSOLUTE MAXIMUM RATINGS

(Notes 1, 2)

Supply Voltages (V_{CC} , V_L)	-0.3V to 6V
Logic Input Voltages (\overline{RE} , DE, DI)	-0.3V to 6V
Line Interface I/O (PA, PB)	-60V to 60V
Line Interface I/O Difference (PB-PA)	-120V to 120V
Receiver Output (RO)	
LTC2876	-0.3V to $V_{CC} + 0.3V$
LTC2877	-0.3V to $V_L + 0.3V$

Operating Ambient Temperature Range (Note 3)

LTC287xC	0°C to 70°C
LTC287xI	-40°C to 85°C
LTC287xH	-40°C to 125°C
Storage Temperature Range	-65°C to 150°C
Lead Temperature (Soldering, 10sec)	300°C

PIN CONFIGURATION

<p>LTC2876</p> <p>TOP VIEW</p> <p>DD PACKAGE 8-LEAD (3mm × 3mm) PLASTIC DFN</p> <p>$T_{JMAX} = 150^{\circ}C$, $\theta_{JA} = 43^{\circ}C/W$, $\theta_{JC} = 5.5^{\circ}C/W$ EXPOSED PAD (PIN 9) IS GND, MUST BE SOLDERED TO PCB</p>	<p>LTC2876</p> <p>TOP VIEW</p> <p>MS8E PACKAGE 8-LEAD PLASTIC MSOP</p> <p>$T_{JMAX} = 150^{\circ}C$, $\theta_{JA} = 40^{\circ}C/W$, $\theta_{JC} = 10^{\circ}C/W$ EXPOSED PAD (PIN 9) IS GND, MUST BE SOLDERED TO PCB</p>
<p>LTC2877</p> <p>TOP VIEW</p> <p>DD PACKAGE 10-LEAD (3mm × 3mm) PLASTIC DFN</p> <p>$T_{JMAX} = 150^{\circ}C$, $\theta_{JA} = 43^{\circ}C/W$, $\theta_{JC} = 5.5^{\circ}C/W$ EXPOSED PAD (PIN 11) IS GND, MUST BE SOLDERED TO PCB</p>	<p>LTC2877</p> <p>TOP VIEW</p> <p>MSE PACKAGE 10-LEAD PLASTIC MSOP</p> <p>$T_{JMAX} = 150^{\circ}C$, $\theta_{JA} = 40^{\circ}C/W$, $\theta_{JC} = 10^{\circ}C/W$ EXPOSED PAD (PIN 11) IS GND, MUST BE SOLDERED TO PCB</p>

ORDER INFORMATION <http://www.linear.com/product/LTC2876#orderinfo>

Lead Free Finish

TUBE	TAPE AND REEL	PART MARKING	PACKAGE DESCRIPTION	TEMPERATURE RANGE
LTC2876CMS8E#PBF LTC2876IMS8E#PBF LTC2876HMS8E#PBF	LTC2876CMS8E#TRPBF LTC2876IMS8E#TRPBF LTC2876HMS8E#TRPBF	LTGTN LTGTN LTGTN	8-Lead Plastic MSOP 8-Lead Plastic MSOP 8-Lead Plastic MSOP	0°C to 70°C -40°C to 85°C -40°C to 125°C
LTC2876CDD#PBF LTC2876IDD#PBF LTC2876HDD#PBF	LTC2876CDD#TRPBF LTC2876IDD#TRPBF LTC2876HDD#TRPBF	LGTM LGTM LGTM	8-Lead Plastic DFN 8-Lead Plastic DFN 8-Lead Plastic DFN	0°C to 70°C -40°C to 85°C -40°C to 125°C
LTC2877CMSE#PBF LTC2877IMSE#PBF LTC2877HMSE#PBF	LTC2877CMSE#TRPBF LTC2877IMSE#TRPBF LTC2877HMSE#TRPBF	LTGTQ LTGTQ LTGTQ	10-Lead Plastic MSOP 10-Lead Plastic MSOP 10-Lead Plastic MSOP	0°C to 70°C -40°C to 85°C -40°C to 125°C
LTC2877CDD#PBF LTC2877IDD#PBF LTC2877HDD#PBF	LTC2877CDD#TRPBF LTC2877IDD#TRPBF LTC2877HDD#TRPBF	LGTP LGTP LGTP	10-Lead Plastic DFN 10-Lead Plastic DFN 10-Lead Plastic DFN	0°C to 70°C -40°C to 85°C -40°C to 125°C

Consult LTC Marketing for parts specified with wider operating temperature ranges.

Consult LTC Marketing for information on nonstandard lead based finish parts.

For more information on lead free part marking, go to: <http://www.linear.com/leadfree/>

For more information on tape and reel specifications, go to: <http://www.linear.com/tapeandreeel/>. Some packages are available in 500 unit reels through designated sales channels with #TRMPBF suffix.

ELECTRICAL CHARACTERISTICS

The ● denotes the specifications which apply over the full operating temperature range, otherwise specifications are at $T_A = 25^\circ\text{C}$. $V_{CC} = V_L = 5\text{V}$ unless otherwise noted.

SYMBOL	PARAMETER	CONDITIONS	MIN	TYP	MAX	UNITS
Supplies						
V_{CC}	Primary Power Supply	PROFIBUS, RS485	●	4.5	5.5	V
		Low Voltage RS485 (Note 6)	●	3.0		V
V_L	Logic Interface Power Supply	LTC2877 Only	●	1.65	V_{CC}	V
I_{CCS}	LTC2876 Supply Current in Shutdown Mode	$DE = 0\text{V}$, $\overline{RE} = V_{CC}$, $DI = V_{CC}$	●	0	5	μA
		$DE = 0\text{V}$, $\overline{RE} = V_{CC}$, $DI = 0\text{V}$	●	12	25	μA
	LTC2877 Supply Current in Shutdown Mode	$DE = 0\text{V}$, $\overline{RE} = V_L = V_{CC}$, $DI = 0\text{V}$ or V_L	●	0	5	μA
I_{CCR}	Supply Current with Only Receiver Enabled	No Load, $DE = 0\text{V}$, $\overline{RE} = 0\text{V}$	●	600	900	μA
I_{CCD}	Supply Current with Only Driver Enabled	No Load, $DE = \overline{RE} = V_{CC} = V_L$	●	700	1100	μA
I_{CCDR}	Supply Current with Both Driver and Receiver Enabled	No Load, $DE = V_{CC} = V_L$, $\overline{RE} = 0\text{V}$	●	750	1200	μA
	LTC2877 Logic Supply Current in Shutdown Mode	$DE = 0\text{V}$, $\overline{RE} = V_L$, $DI = V_L$	●	0	5	μA
		$DE = 0\text{V}$, $\overline{RE} = V_L$, $DI = 0\text{V}$	●	12	25	μA
	LTC2877 Logic Supply Current with Both Driver and Receiver Enabled	$DE = V_L$, $\overline{RE} = 0\text{V}$, $DI = V_L$	●	30	60	μA
		$DE = V_L$, $\overline{RE} = 0\text{V}$, $DI = 0\text{V}$	●	65	120	μA

LTC2876/LTC2877

ELECTRICAL CHARACTERISTICS

The ● denotes the specifications which apply over the full operating temperature range, otherwise specifications are at $T_A = 25^\circ\text{C}$. $V_{CC} = V_L = 5\text{V}$ unless otherwise noted.

SYMBOL	PARAMETER	CONDITIONS	MIN	TYP	MAX	UNITS
Driver						
$V_{OD(PP)}$	Differential Bus Output Voltage ($B'-A'$) with PROFIBUS Load	PROFIBUS LOAD (Figure 1) $R_{CABLE} = 0\Omega, V_{CC} = 4.5\text{V to } 5.5\text{V}$ ● $R_{CABLE} = 5.5\Omega, V_{CC} = 4.5\text{V to } 5.5\text{V}$ ● $R_{CABLE} = 11\Omega, V_{CC} = 4.75\text{V to } 5.5\text{V}$ ●	4 4 4		7 7 7	$V_{P-P(DIFF)}$ $V_{P-P(DIFF)}$ $V_{P-P(DIFF)}$
$V_{BPP-APP}$	Single-Ended Bus Output Amplitude Difference ($B'_{PP} - A'_{PP}$)	All of the Conditions Above			0.5	V
$V_{BPP+APP}$	Single-Ended Bus Output Amplitude Sum $ B'_{PP} + A'_{PP} $	All of the Conditions Above	4			V
$ V_{OD(485)} $	RS485 Differential Driver Output Voltage, in Either Logic State	Figure 2 with No Load			V_{CC}	V
		$R_L = 27\Omega, V_{CC} = 4.5\text{V to } 5.5\text{V}$ (Figure 2)	1.5		3.4	V
		$R_L = 27\Omega, V_{CC} = 3.0\text{V to } 3.6\text{V}$ (Figure 2)	0.8		1.8	V
$ V_{OD(422)} $	RS422 Differential Driver Output Voltage, Either Logic State	Figure 2 with No Load			V_{CC}	V
		$R_L = 50\Omega, V_{CC} = 4.5\text{V to } 5.5\text{V}$ (Figure 2)	2		4	V
		$R_L = 50\Omega, V_{CC} = 3.0\text{V to } 3.6\text{V}$ (Figure 2)	1		2	V
$\Delta V_{OD(485)} , \Delta V_{OD(422)} $	RS485, RS422 Change in Magnitude of Driver Differential Output Voltage	$R_L = 27\Omega$ (RS485) or $R_L = 50\Omega$ (RS422) (Figure 2)			0.2	V
$V_{OC(485)}, V_{OC(422)}$	RS485, RS422 Driver Common-Mode Output Voltage	$R_L = 27\Omega$ (RS485) or $R_L = 50\Omega$ (RS422) (Figure 2)			3	V
$\Delta V_{OC(485)} , \Delta V_{OC(422)} $	RS485, RS422 Change in Magnitude of Driver Common-Mode Output Voltage	$R_L = 27\Omega$ (RS485) or $R_L = 50\Omega$ (RS422) (Figure 2)			0.2	V
I_{OSD}	Maximum Driver Short-Circuit Current	$-60\text{V} \leq (PB \text{ or } PA) \leq 60\text{V}$ (Figure 3)		± 150	± 250	mA
Receiver						
I_{IN}	Input Current (PA, PB)	$V_{CC} = 0\text{V or } 5\text{V}, V_{BUS} = 12\text{V}$ (Figure 4) ● $V_{CC} = 0\text{V or } 5\text{V}, V_{BUS} = -7\text{V}$ (Figure 4) ●	-100		160	μA μA
R_{IN}	Input Resistance	$V_{BUS} = -25\text{V or } 25\text{V}$ (Figure 4)	75	112	135	k Ω
V_{CM}	Common Mode Input Voltage ($PA+PB$)/2 for Data Reception				± 25	V
V_{TS+}	Differential Input Signal Threshold Voltage (PB-PA) Rising	$-25\text{V} \leq V_{CM} \leq 25\text{V}$, Edge Rates $> 100\text{mV}/\mu\text{s}$ (Note 5) (Figure 13)	50	120	200	mV
V_{TS-}	Differential Input Signal Threshold Voltage (PB-PA) Falling	$-25\text{V} \leq V_{CM} \leq 25\text{V}$, Edge Rates $> 100\text{mV}/\mu\text{s}$ (Note 5) (Figure 13)	-50	-120	-200	mV
ΔV_{TS}	Differential Input Signal Hysteresis	Edge Rates $> 100\text{mV}/\mu\text{s}$ (Note 5) (Figure 13)		240		mV
V_{TFS+}	Differential Input Failsafe Threshold Voltage (PB-PA) Rising	$-25\text{V} \leq V_{CM} \leq 25\text{V}$, DC Bus Voltages (Figure 13)	-20	-75	-200	mV
V_{TFS-}	Differential Input Failsafe Threshold Voltage (PB-PA) Falling	$-25\text{V} \leq V_{CM} \leq 25\text{V}$, DC Bus Voltages (Figure 13)	-50	-120	-200	mV
ΔV_{TFS}	Differential Input Failsafe Hysteresis	DC Bus Voltages (Figure 13)		45		mV
V_{OH}	Receiver Output High Voltage	$V_{CC} \geq 4.5\text{V}, I(RO) = -3\text{mA}$ (LTC2876) ●			$V_{CC} - 0.4\text{V}$	V
		$V_L \geq 2.25\text{V}, I(RO) = -3\text{mA}$ (LTC2877) ●			$V_L - 0.4\text{V}$	V
		$V_L < 2.25\text{V}, I(RO) = -2\text{mA}$ (LTC2877) ●			$V_L - 0.4\text{V}$	V
V_{OL}	Receiver Output Low Voltage	$V_L \geq 1.65\text{V}, I(RO) = 3\text{mA}$ (LTC2877) ●			0.4	V
		$V_{CC} \geq 3.0\text{V}, I(RO) = 3\text{mA}$ (LTC2876) ●			0.4	V
	Receiver Three-State (High Impedance) Output Current on RO	$\overline{RE} = \text{High}, RO = 0\text{V}$		-20	-40	μA
	Receiver Three-State (High Impedance) Output Current on RO	$\overline{RE} = \text{High}, RO = V_{CC}$ (LTC2876) or V_L (LTC2877)		0	5	μA

28767fa

ELECTRICAL CHARACTERISTICS

The ● denotes the specifications which apply over the full operating temperature range, otherwise specifications are at $T_A = 25^\circ\text{C}$. $V_{CC} = V_L = 5\text{V}$ unless otherwise noted.

SYMBOL	PARAMETER	CONDITIONS	MIN	TYP	MAX	UNITS
	Receiver Short-Circuit Current	$\overline{RE} = \text{Low}$, $RO = 0\text{V}$ or V_{CC} (LTC2876) or V_L (LTC2877)	●	±12	±20	mA
Logic						
	Low Level Input Voltage (DE, DI, \overline{RE})	LTC2876, $3.0 \leq V_{CC} \leq 5.5\text{V}$	●		$0.25 \cdot V_{CC}$	V
		LTC2877, $1.65 \leq V_L \leq 5.5\text{V}$	●		$0.25 \cdot V_L$	V
	High Level Input Voltage (DE, DI, \overline{RE})	LTC2876, $3.0 \leq V_{CC} \leq 5.5\text{V}$	●	$0.75 \cdot V_{CC}$		V
		LTC2877, $1.65 \leq V_L \leq 5.5\text{V}$	●	$0.75 \cdot V_L$		V
	Logic Input Current Low (DE)	DE = 0V	●	0	-5	μA
	Logic Input Current Low (DI, \overline{RE})	DI or $\overline{RE} = 0\text{V}$	●	-3	-10	μA
	Logic Input Current High (DE)	DE = V_{CC} (LTC2876) or V_L (LTC2877)	●	3	10	μA
	Logic Input Current High (DI, \overline{RE})	(DI, \overline{RE}) = V_{CC} (LTC2876) or V_L (LTC2877)	●	0	5	μA
ESD (Note 4)						
	ESD Protection Level of Interface Pins (PA, PB)	Human Body Model to GND or V_{CC} , or V_L , Powered or Unpowered			±26	kV
		Human Body Model to GND, Unpowered			±52	kV
	ESD Protection Level of All Other Pins (DE, DI, \overline{RE} , V_{CC} , V_L)	Human Body Model			±15	kV

SWITCHING CHARACTERISTICS

The ● denotes the specifications which apply over the full operating temperature range, otherwise specifications are at $T_A = 25^\circ\text{C}$. $V_{CC} = V_L = 5\text{V}$ unless otherwise noted.

SYMBOL	PARAMETER	CONDITIONS	MIN	TYP	MAX	UNITS
f_{MAX}	Maximum Data Rate	(Note 4)	●	20		Mbps
Driver						
t_{PLHD} , t_{PHLD}	Driver Input to Output	$V_{CC} = 3.3\text{V}$ or 5V (Figure 5)	●	13	50	ns
Δt_{PD}	Driver Input to Output Difference $ t_{\text{PLHD}} - t_{\text{PHLD}} $	(Figure 5)	●	2	9	ns
t_{SKEWD}	Driver Output PB to Output PA	(Figure 5)	●		±9	ns
t_{RD} , t_{FD}	Driver Rise or Fall Time	$V_{CC} = 3.3\text{V}$ or 5V (Figure 5)	●	4	15	ns
t_{ZLD} , t_{ZHD} , t_{LZD} , t_{HZD}	Driver Enable or Disable Time	$\overline{RE} = 0\text{V}$ (Figure 6)	●		180	ns
t_{ZHSD} , t_{ZLSD}	Driver Enable from Shutdown	$\overline{RE} = \text{High}$ (Figure 6)	●		15	μs
t_{SHDND}	Time to Shutdown with DE	$\overline{RE} = \text{High}$ (Figure 6)	●		180	ns
Receiver						
t_{PLHR} , t_{PHLR}	Receiver Input to Output	$V_{\text{CM}} = 2.25\text{V}$, (PB-PA) = ±1.5V, t_{R} and $t_{\text{F}} < 4\text{ns}$, $V_{CC} = 3.3\text{V}$ or 5V (Figure 7)	●	50	70	ns
Δt_{PR}	Receiver Input to Output Difference $ t_{\text{PLHR}} - t_{\text{PHLR}} $	(Figure 7)	●	2	14	ns
t_{RR} , t_{FR}	Receiver Output Rise or Fall Time	(Figure 7)	●	3	15	ns
t_{ZLR} , t_{ZHR} , t_{LZR} , t_{HZR}	Receiver Enable/Disable Time	DE = High (Figure 8)	●		40	ns
t_{ZHSDR} , t_{ZLSDR}	Receiver Enable from Shutdown	DE = 0V, (Figure 9)	●		9	μs
t_{SHDNR}	Time to Shutdown with \overline{RE}	DE = 0V, (Figure 9)	●		40	ns

ELECTRICAL CHARACTERISTICS

Note 1: Stresses beyond those listed under Absolute Maximum Ratings may cause permanent damage to the device. Exposure to any Absolute Maximum Rating condition for extended periods may affect device reliability and lifetime.

Note 2: All currents into device pins are positive; all currents out of device pins are negative. All voltages are referenced to device ground unless otherwise specified.

Note 3: This IC includes overtemperature protection that is intended to protect the device during momentary overload conditions. Junction temperature exceeds 150°C when overtemperature protection is active. Continuous operation above the specified maximum operating temperature may result in device degradation or failure.

Note 4: Not tested in production.

Note 5: The dependency on edge rate is tested indirectly.

Note 6: Does not meet RS485 or PROFIBUS specifications. See the Applications Information section for more information about running with a 3V supply.

TYPICAL PERFORMANCE CHARACTERISTICS

$T_A = 25^\circ\text{C}$. $V_{CC} = V_L = 5\text{V}$, unless otherwise noted. (Note 2)

V_{CC} Supply Current vs Voltage for Various Modes, No Load



V_{CC} Supply Current vs Temperature for Various Modes, No Load

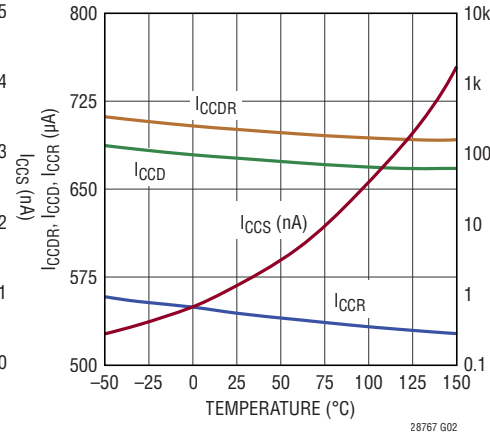

V_{CC} Supply Current vs Data Rate

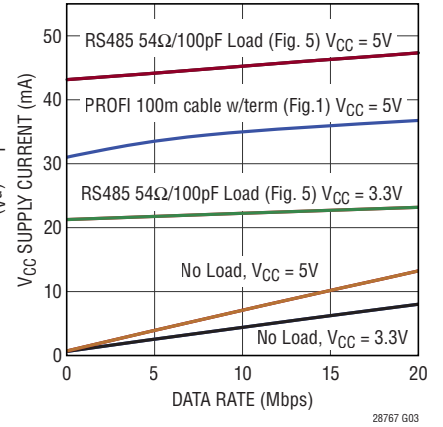

V_L Supply Current vs Data Rate



Driver Differential Output Voltage vs Supply Voltage

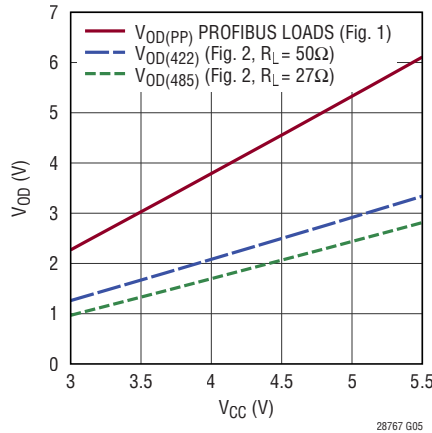

Driver Differential Output Voltage vs Temperature

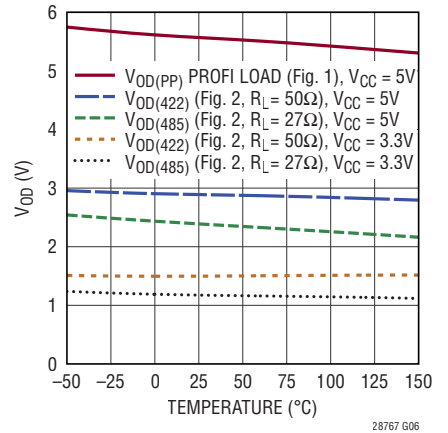

Driver Output Low/High Voltage vs Output Current



Driver Output Short-Circuit Current vs Voltage

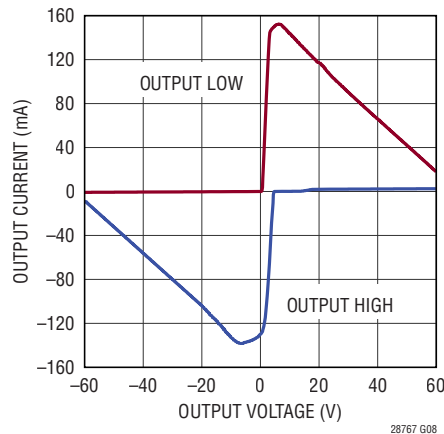

Driver and Receiver Propagation Delay vs V_{CC}

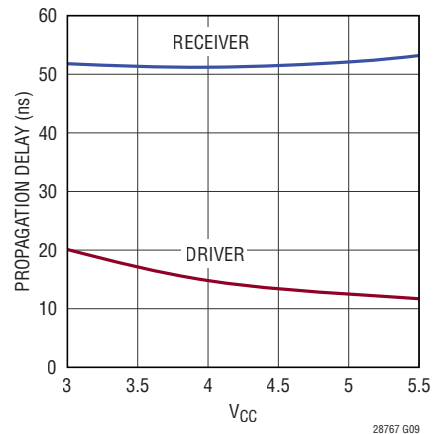

TYPICAL PERFORMANCE CHARACTERISTICS

$T_A = 25^\circ\text{C}$. $V_{CC} = V_L = 5\text{V}$, unless otherwise noted. (Note 2)

Driver Propagation Delay vs Temperature



Driver Output Skew vs Temperature



Driver Output Propagation Delay Difference vs Temperature



Receiver Propagation Delay vs Temperature



Receiver Propagation Delay Difference vs Temperature



Receiver Output Voltage vs Output Current (Source and Sink)



Receiver Output Voltage vs V_L Voltage (LTC2877)

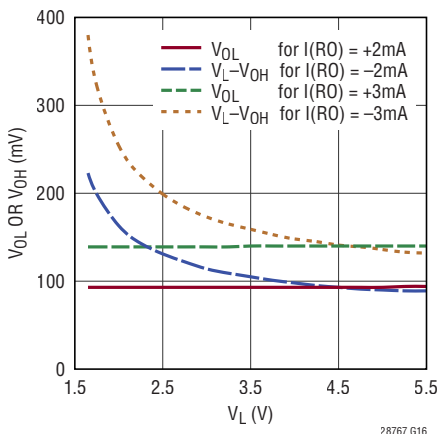

PROFIBUS Operation at 12Mbps

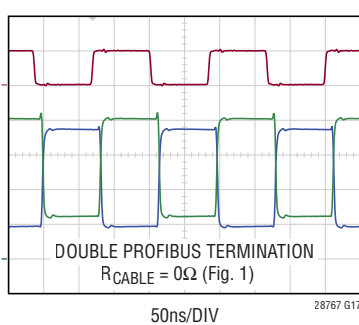

RS485 Operation at 20Mbps

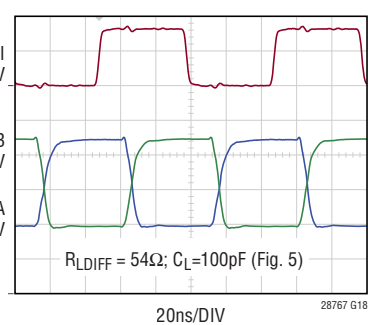

PIN FUNCTIONS (LTC2876/LTC2877)

RO (Pin 1): Receiver Output. Supplied by V_{CC} in the LTC2876 or V_L in the LTC2877. If the receiver is enabled (\overline{RE} low) and $PB-PA > 200mV$, then RO will be high. If $PB-PA < -200mV$, then RO will be low. If the receiver inputs are open, shorted, or terminated without being driven for more than about $1.5\mu s$, RO will be high. Integrated 250k pull-up resistor to supply.

\overline{RE} (Pin 2): Receiver Enable. Logic levels defined by the V_{CC} supply in the LTC2876 or the V_L supply in the LTC2877. A low input enables the receiver. A high input forces the receiver output into a high impedance state. If \overline{RE} is high with DE low, the device enters a low power shutdown state. Integrated 500k pull-up resistor to supply.

DE (Pin 3): Driver Enable. Logic levels defined by the V_{CC} supply in the LTC2876 or the V_L supply in the LTC2877. A high input on DE enables the driver. A low input forces the driver outputs into a high impedance state. If DE is low with \overline{RE} high, the device enters a low power shutdown state. Integrated 500k pull-down resistor to ground.

DI (Pin 4): Driver Input. Logic levels defined by the V_{CC} supply in the LTC2876 or the V_L supply in the LTC2877. If the driver outputs are enabled (DE high), then a low on DI drives a negative differential voltage between PB and PA. A high on DI, with the driver outputs enabled, drives a positive differential voltage between PB and PA. Integrated 500k pull-up resistor to supply.

V_L (NA/Pin 5): Logic supply: $1.65V \leq V_L \leq V_{CC}$. Powers RO, \overline{RE} , DE, and DI on LTC2877 only. Bypass with $0.1\mu F$ ceramic capacitor to GND.

GND (Pin 5, 9/Pin 6,11): Ground

NC (NA/Pin 7): Not Internally Connected.

PB (Pin 6/Pin 8): PROFIBUS B. Non-inverting receiver input and non-inverting driver output. Connect this to the B wire (positive) in a PROFIBUS network. In most non-PROFIBUS applications, this should connect to the A terminal. See the Applications Information section for more information on A vs B naming conventions.

PA (Pin 7/Pin 9): PROFIBUS A. Inverting receiver input and inverting driver output. Connect this to the A wire (negative) in a PROFIBUS network. In most non-PROFIBUS applications, this should connect to the B terminal. See the Applications Information section for more information on A vs B naming conventions.

V_{CC} (Pin 8/Pin 10): Power Supply. $4.5V \leq V_{CC} \leq 5.5V$ for PROFIBUS and RS485 compliant applications; $3.0V \leq V_{CC} \leq 5.5V$ for a wide range of usage. See 3.3V Operation in the Applications Information section for details. Bypass with $1\mu F$ ceramic capacitor to GND.

Exposed Pad (Pin 9/Pin 11): Must be connected to GND.

BLOCK DIAGRAM



TEST CIRCUITS



Figure 1. Driver Differential Output Voltages for PROFIBUS Load



Figure 2. Driver Output Voltages in RS485 and RS422 Configurations

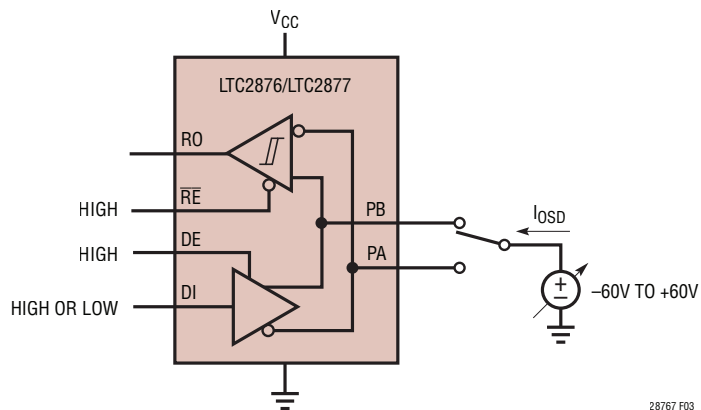

Figure 3. Drive Output Short-Circuit Current

TEST CIRCUITS



Figure 4. Receiver Input Current and Input Resistance

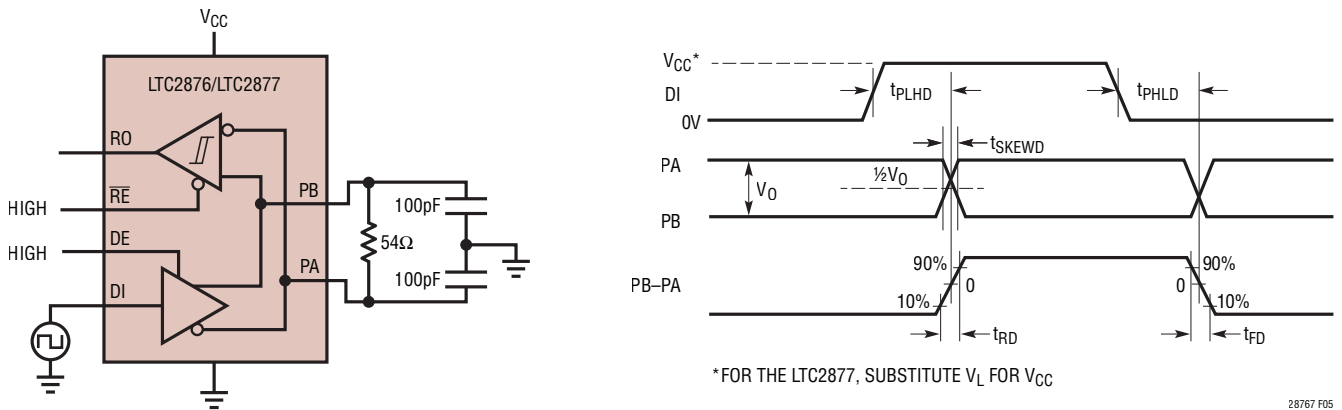

Figure 5. Driver Timing Measurement

TEST CIRCUITS



28767 F06

Figure 6. Driver Enable, Disable and Shutdown Timing Measurements

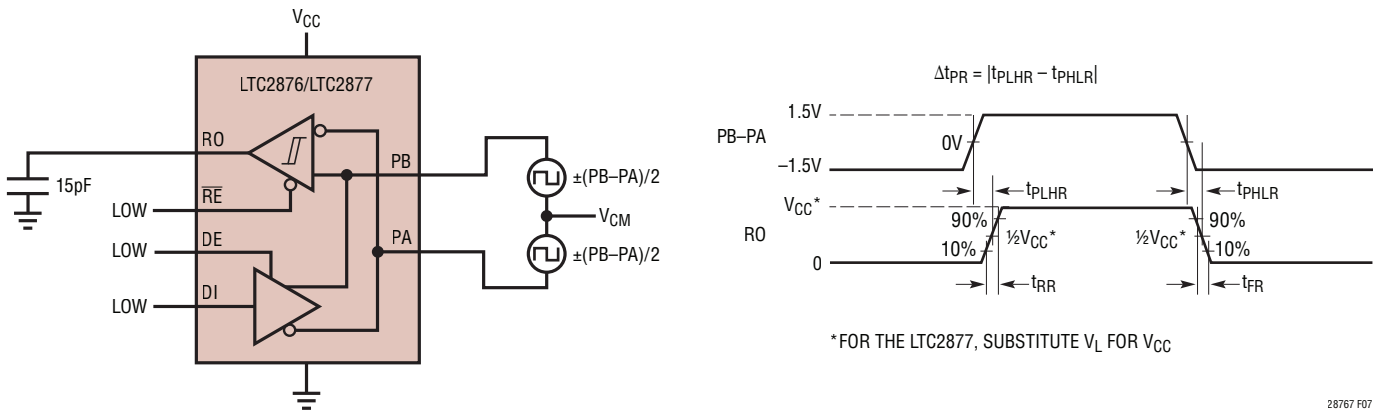

28767 F07

Figure 7. Receiver Propagation Delay Measurements

TEST CIRCUITS



*FOR THE LTC2877, SUBSTITUTE V_L FOR V_{CC}

28767 F08

Figure 8. Receiver Enable and Disable Timing Measurements



*FOR THE LTC2877, SUBSTITUTE V_L FOR V_{CC}

28767 F09

Figure 9. Receiver Shutdown Timing Measurements

APPLICATIONS INFORMATION

Note: Specifications in this section represent typical values unless otherwise noted.

PROFIBUS-DP AND RS485

PROFIBUS-DP can communicate over a variety of media, including copper wires, fiber optics, and even air in an infrared communicator. By far, the most commonly used media is a twisted pair of wires connecting devices that communicate with TIA/EIA-485-A (RS485) transceivers.

RS485 offers high speed differential signaling that is robust for communication between multiple devices over long distances in noisy environments such as factory applications.

Not All RS485 Transceivers Are Suitable for PROFIBUS

Although the PROFIBUS standard specifies the use of RS485 devices at the physical layer, there are differences in the cable, termination, and driver requirements from RS485. A device meeting RS485 specifications may not

be compliant to PROFIBUS requirements. The LTC2876/LTC2877 was designed specifically to meet PROFIBUS and RS485 requirements and is tested in a way that ensures this.

Cable and Termination Differences from RS485

The cable and termination network used for PROFIBUS is different than for RS485 as illustrated in Figure 10. The PROFIBUS network includes bus biasing resistors that are used in conjunction with the differential termination resistors on each end of the bus. The cable is a shielded twisted pair with an impedance of 150Ω . Oddly enough, the effective differential resistance of the specified termination network is 172Ω , which is not a perfect match for the 150Ω cable, resulting in a slightly underdamped network. This manifests itself as a small bump, or increase in the signal voltage, at the receiving end of the cable, lasting twice as long as the cable propagation delay.

In contrast, the RS485 network shows the preferred configuration with only differential termination resistors at each end of the bus, matching the 120Ω characteristic impedance of the cable.



28767 F10

Figure 10. Cable and Termination Differences in RS485 and PROFIBUS Multi-Node Networks. PROFIBUS Type A Cable and Termination Shown in PROFIBUS Example (Top)

APPLICATIONS INFORMATION

Driver Output Requirement Differences from RS485

The driver requirements for PROFIBUS are specified differently than how the RS485 standard specifies them. A key difference is the terminated driver output voltage, V_{OD} , as described below.

The PROFIBUS driver output levels are required to meet the following condition as stated in the “Test Specification for PROFIBUS DP Masters” and “Test Specification for PROFIBUS DP Slaves”:

- The differential voltage between A- and B-line shall be a minimum of 4V and a maximum of 7V, peak-to-peak differential.
- This measurement shall be taken at the far end of the cable in use, with termination at each end.

On the other hand, RS485 specifies the following:

- The differential voltage between A- and B-line shall be a minimum of 1.5V and a maximum of 5V, peak differential.
- This measurement shall be taken at the driver terminals with a 54 Ω resistor between A and B.

Clearly, these requirements are quite different. A common misunderstanding is that if an RS485 driver develops more than 2.1V across a 54 Ω RS485 resistive load, then it will meet PROFIBUS requirements when used with a PROFIBUS termination network. This is not always the case. Furthermore, the strength of the driver can be too high, exceeding the upper limit of the PROFIBUS Specification (7V_{P-P}). The best way to ensure PROFIBUS compliance is to test the device with a PROFIBUS load.

The LTC2876 and LTC2877 are tested with a PROFIBUS load and with extra resistance added to represent cable losses for 100m and 200m to ensure they meet the PROFIBUS V_{OD} requirement. The devices are also fully tested with RS485 loads to ensure they meet RS485 specifications.

See the Electrical Characteristics section for details.

DRIVER OPERATION

The driver is enabled when the LTC2876/LTC2877 is powered up, DE is high, and there are no thermal faults. The polarity of PB–PA follows that of DI. That is, when DI is high, PB drives to a voltage that is greater than PA. If DI is low, PA is higher than PB. When the driver is disabled with DE low, both outputs are high impedance and the overall pin resistance is dominated by the receiver inputs sharing pins PA and PB.

DRIVER OVERVOLTAGE AND OVERCURRENT PROTECTION

The driver outputs PA and PB are protected from short circuits to any voltage within the absolute maximum range of –60V to +60V, with a maximum differential voltage of –120V to +120V. The maximum short-circuit current to any voltage within this range is ± 250 mA. The driver includes a progressive foldback current limiting circuit that continuously reduces the driver current limit with increasing output short circuit voltage to better manage power dissipation and heating effects.

The LTC2876/LTC2877 also features thermal shutdown protection that disables the driver and receiver in case of excessive power dissipation (see Note 3).

RECEIVER

The receiver provides full PROFIBUS and RS485 compatibility. When enabled, the state of RO reflects the polarity of (PB–PA). When the receiver is disabled, the output is high impedance and RO weakly pulled high through an internal 250k pull-up resistor.

High Receiver Input Resistance Permits 200 Nodes

The RS485 and PROFIBUS specifications allows for up to 32 receivers, each contributing one unit load, to be connected together in one network. The input resistance of the LTC2876/LTC2877 is guaranteed to be at least 6.25 times higher, and drawing proportionally less current, than a standard RS485 load, permitting a total of 200 receivers per contiguous network. The input load of the receiver is unaffected by enabling/disabling the receiver or by powering/depowering the device.

APPLICATIONS INFORMATION

Balanced Signal Threshold

The LTC2876/LTC2877 differential threshold is 120mV for rising input signals and -120mV for falling signals. This constitutes 240mV of hysteresis, which offers a high rejection to signal noise that can otherwise falsely trip a receiver. Since these thresholds are centered around zero volts (i.e. “balanced”), the duty cycle is preserved for small amplitude signals with slewed edges—typical of what is observed at the end of a long cable. Figure 11 illustrates this point.

In contrast to this, some RS485 receivers have an unbalanced receiver threshold, used to address failsafe conditions (more on this below). That is, the rising and falling differential signal thresholds are both negative. Figure 12 illustrates an example where the rising threshold is -75mV and falling threshold is -120mV . This has two disadvantages. First, the hysteresis is only 45mV in this example, reducing the tolerance to noise, compared to the 240mV of hysteresis in the LTC2876/LTC2877. Secondly, these unbalanced thresholds cause a duty cycle or pulse width distortion at the receiver output relative to the input signal. Figure 12 illustrates how a competitor part, using the negative thresholds in this example introduces a duty cycle distortion that becomes increasingly worse with low input signal levels and slow input edge rates.

Failsafe Operation

The LTC2876 and LTC2877 have a failsafe feature that guarantees the receiver output will be in a logic 1 state (the idle state) when the inputs are shorted, left open, or terminated but not driven for more than about $1.5\mu\text{s}$. This failsafe feature is guaranteed to work for inputs spanning the entire common mode range of -25V to $+25\text{V}$.

Many RS485 receivers simply employ a negative threshold (for rising and falling signals) to achieve failsafe operation. If the inputs are shorted together (0V differential), the receiver produces a high output, consistent with failsafe. However, this asymmetrical threshold comes with the disadvantages of pulse width distortion and sensitivity to signal noise as described in the section above.

The LTC2876/LTC2877 achieves full failsafe operation, while reaping the benefits of a balanced receiver threshold.



Figure 11. The LTC2876/LTC2877 Balanced Signal Threshold Voltages Preserve the Duty Cycle of an Incoming Signal. The Differential Signal Received (Top) Has a Duty Cycle of 50%, and Is Reflected In the Receiver Output, RO (Bottom)



Figure 12. Typical Competitor Unbalanced Signal Threshold Voltages Distort the Duty Cycle of an Incoming Signal. Input Is 50% Duty Cycle (Top) But the Receiver Output Is Not 50% Duty Cycle (Bottom)

Failsafe operation is performed with a window comparator to determine when the differential input voltage falls between the rising and falling signal thresholds (V_{TS+} , and V_{TS-}). If this condition persists for more than about $1.5\mu\text{s}$ then the receiver switches over to using the failsafe thresholds (V_{TFS-} , V_{TFS+}), as illustrated in Figure 13 and Figure 14. The delay allows normal data signals to transition through the threshold region without being interpreted as a failsafe condition, and thus maintaining the benefits of a balanced threshold receiver. However, for fault conditions (e.g., shorted, open, or undriven lines) that persist for more than $1.5\mu\text{s}$, the failsafe thresholds are engaged and the receiver output drives high, indicating this condition. The failsafe delay also prevents unwanted receiver output

APPLICATIONS INFORMATION



Figure 13. The LTC2876/LTC2877 Signal Thresholds (V_{TS-} , V_{TS+}) and Failsafe Thresholds (V_{TFs-} , V_{TFs+})



Figure 14. LTC2876/LTC2877 Receiver Operation. Event 1: Signal Rises into Region Between Signal Thresholds, Resulting in the RO Transitioning to a Failsafe Condition After a Fixed Delay of About $1.5\mu\text{s}$. Event 2: Input Signal Falls Below Negative Signal Threshold, Resulting in an Immediate Fall on RO. Event 3: Signal Glitches into the Region Between Signal Thresholds for a Period Less Than the Failsafe Delay Time ($\sim 1.5\mu\text{s}$), Resulting in an Unchanged Output. Event 4: Signal Transitions Above Rising Signal Threshold, Resulting in an Immediate Rise in RO

glitches resulting from receiver inputs that momentarily cross into the region between the signal rising and falling thresholds as illustrated in Figure 14, event 3.

SHUTDOWN MODE DELAY

The LTC2876 and LTC2877 feature a low power shutdown mode that is entered when both the driver and receiver are simultaneously disabled (pin DE low and $\overline{\text{RE}}$ high). A shutdown mode delay of approximately 250ns (not tested in production) is imposed after the state is received before the chip enters shutdown. If either DE goes high

or $\overline{\text{RE}}$ goes low during this delay, the delay timer is reset and the chip does not enter shutdown. This reduces the chance of accidentally entering shutdown if DE and $\overline{\text{RE}}$ are driven in parallel by a slowly changing signal or if DE and $\overline{\text{RE}}$ are driven by two independent signals with a timing skew between them.

This shutdown mode delay does not affect the outputs of the transmitter and receiver, which start to switch to the high impedance state upon the reception of their respective disable signals as defined by the parameters t_{SHDND} and t_{SHDNR} . The shutdown mode delay affects only the time when all the internal circuits that draw DC power from V_{CC} are turned off.

POWER-UP/DOWN GLITCH-FREE OUTPUTS

The LTC2876 and LTC2877 employ an undervoltage detection circuit to control the activation of the on-chip circuitry. During power-up, PB, PA, and RO are undriven, until the V_{CC} supply reaches a voltage sufficient to reliably operate the chip. In this mode, only the internal pull-up resistor on RO and the receiver input resistance to ground on PA and PB offer weak conduction paths at those pins. As the supply voltage rises above the undervoltage threshold, and if the device is configured for drive mode, the PB and PA pins become active and are driven to a state that reflects the input condition on DI. Likewise, if the device is configured for receive mode, the RO pin is driven high or low to reflect the state of the differential voltage across PB-PA.

During power down, the reverse occurs; the supply undervoltage detection circuit senses low supply voltage and immediately puts the chip into shutdown. The driver and receiver outputs go to the undriven state. RO is pulled up through the internal 250k pull-up resistor and PA, PB are pulled low through the 125k receiver input resistors.

If the LTC2876/LTC2877 is powered or depowered when configured for shutdown ($\overline{\text{RE}} = 0\text{V}$ and $\text{DE} = V_{\text{L}}$ (LTC2877) or V_{CC} (LTC2876) then RO, PB, and PA will remain in the undriven state, without glitching high or low during the supply transition. This allows the powering and depowering of the LTC2876/LTC2877 when connected onto a live network without disturbing the lines.

APPLICATIONS INFORMATION

±60V FAULT PROTECTION

TIA/EIA-485-A specifies that ground shifts between two devices on a network can be as large as $-7V$ to $+12V$ during operation. Most RS485 transceivers cannot safely tolerate voltages on their interface pins that are much higher than this range. However, industrial installations may encounter voltages much greater than this, causing damage to the devices.

This requirement means that a driver and receiver sharing communication on a network must be able to operate with a signal common mode voltage difference of $-7V$ to $12V$. Competing PROFIBUS transceivers can be damaged by pin voltages exceeding these levels by only a few volts. The limited overvoltage tolerance makes implementation of effective external protection networks difficult without interfering with proper data network performance. Replacing standard RS485 transceivers with the LTC2876 or LTC2877 can eliminate field failures due to overvoltage faults without using costly external protection devices.

The $\pm 60V$ fault protection of the LTC2876/LTC2877 is achieved by using a high voltage BiCMOS integrated circuit

technology. The naturally high breakdown voltage of this technology provides protection in powered off and high impedance conditions. Figure 15 further illustrates how the driver and receiver inputs tolerate large voltages above the supply and below ground without excessive device currents. As shown, the driver outputs are reverse-diode protected from voltages back-driven above V_{CC} or below ground. The receiver inputs use resistive dividers that tolerate large positive and negative voltages. The LTC2876/LTC2877 is protected from $\pm 60V$ bus faults even with the loss of GND or V_{CC} .

±25V EXTENDED COMMON MODE RANGE

The LTC2876/LTC2877 receiver features an extended common mode range of $-25V$ to $+25V$. The wide common mode range increases the reliability of operation in environments with high common mode voltages created by electrical noise or local ground potential differences due to ground loops. This extended common mode range allows the LTC2876/LTC2877 to transmit and receive under conditions that would cause data errors or possible device damage in competing products.



Figure 15. Internal Circuit Structure at PA/PB Pins That Tolerates Large Positive and Negative Voltages

APPLICATIONS INFORMATION

ELECTRICAL OVERSTRESS PROTECTION

Equipment used in industrial environments is often exposed to extremely high levels of electrical overstress due to phenomena such as electrostatic discharges (ESD) from personnel or equipment, electrical fast transients (EFT) from switching high current inductive loads, and even lightning surges. The LTC2876/LTC2877 has been designed to thrive in these adverse conditions.

ESD

Perhaps the most common exposure to electrical overstress is ESD, which results from the build-up of electrical

charge on one object, and discharged onto another in close proximity. The LTC2876/LTC2877 features exceptionally robust ESD protection. The bus interface pins (PB and PA) are protected to $\pm 52\text{kV}$ human body model (HBM) with respect to GND when unpowered and $\pm 26\text{kV}$ with respect to GND, V_{CC} , or V_L when powered, without latchup or damage, in any mode of operation. Every other pin on the device is protected to $\pm 15\text{kV}$ ESD (HBM) for all-around robustness. Figure 16 shows an unprotected LTC2876 struck repeatedly with 26kV from an ESD gun using air discharge to illustrate the strike energy. The device continues to function normally after the strikes, without damage or cycling the power.



Figure 16. This Single Exposure Image Captures the Striking Robustness of an Unprotected LTC2876 Hit Repeatedly with 26kV ESD Discharges While Operating without Damage or Circuit Latchup

APPLICATIONS INFORMATION

The IEC standard for ESD, IEC 61000-4-2, specifies a very fast (sub-nanosecond) edge transient stimulus intended for system level ESD testing and not specified at the device level. However, if it is applied directly to the bus interface pins, without any external protection devices, the LTC2876/LTC2877 is protected to 4kV IEC when used in a typical application, powered or unpowered, and terminated with the standard PROFIBUS load. This is not tested in production.

EFT

Electrical fast transients can result from arcing contacts in switches and relays, common when switching inductive loads. The IEC standard for EFT is IEC61000-4-4 and specifies a repetitive burst pattern lasting 60 seconds. The LTC2876/LTC2877 is robust to EFT events and passes the highest level recognized in the IEC standard: level 4, $\pm 2\text{kV}$ on the PA and PB pins, without any external protection.

Auxiliary Protection for Surge

Surge events represent the most severe transient conditions caused by such things as load switching in power distribution systems, high current short circuit faults, and lightning strikes. These are addressed in standard IEC 61000-4-5, which specifies repetitive voltage and current waveforms used to deliver high power stimulus lasting tens of microseconds each. The LTC2876/LTC2877 is designed for high robustness against ESD and EFT, but the on-chip protection is not able to absorb the energy associated with the IEC 61000-4-5 surge transients. External protection is necessary to achieve a high level of surge protection, and can also extend the ESD and EFT protection to extremely high levels.

In addition to providing transient protection, externally connected devices must preserve the ability of the LTC2876/LTC2877 to operate over a wide common mode voltage and yet safely clamp the pin voltage low enough to avoid damage during the overstress event. The added protection must be low in capacitance to avoid excessively loading

the transceiver bus, allowing operation at full data rate. The LTC2876/LTC2877's $\pm 60\text{V}$ pin rating makes it easy to find protection devices meeting these requirements. Figure 21 shows a solution providing $\pm 4\text{kV}$ protection of the bus Interface pins (PA and PB) for all three IEC 61000 standards as follows:

IEC 61000-4-5 2nd Ed. 2005-11 Surge Level 4: $\pm 4\text{kV}$ (line to GND, 8/20 μs waveform, each line coupled to generator through 80 Ω resistor per Figure 14 of the standard)

IEC 61000-4-4 2nd Ed. 2004-07 EFT Level 4: $\pm 4\text{kV}$ (line to GND, 5kHz repetition rate, 15ms burst duration every 300ms, 60s test duration, discharge coupled to bus pins through 100pF capacitor per paragraph 7.3.2 of the standard)

IEC 61000-4-2 2nd Ed. 2008-12 ESD Level 3: $\pm 4\text{kV}$ contact (line to GND, direct discharge to bus pins with transceiver and standard PROFIBUS resistor load and protection circuit mounted on a ground referenced test card per Figure 4 of the standard)

The TVS devices in Figure 21 have a typical clamp voltage of about 36V, comfortably beyond the LTC2876/LTC2877's common mode operating range of $\pm 25\text{V}$ and well below the $\pm 60\text{V}$ rating. Since the LTC2876/LTC2877 bus pins are rated for $\pm 60\text{V}$, the clamping device must maintain voltages less than this when conducting peak current during the overstress event. This relatively wide voltage window permits the use of smaller, more resistive clamps, which generally also have less capacitance.

Two of these TVS devices are used in an antiparallel configuration because each can only protect in one polarity. The benefit of these uni-directional TVS devices is their low capacitance, offering a total load of only about 50pF to the signal lines in this configuration, permitting the LTC2876/LTC2877 to communicate at maximum data rates with no significant performance degradation.

APPLICATIONS INFORMATION

BUS PINS PA & PB NAMING CONVENTION

PROFIBUS communicates with RS485 signaling through a differential signal interface. These wires are labeled A and B. The PROFIBUS standard specifies that the bus wire B takes on a positive value with respect to bus wire A when no station is transmitting data (during the idle periods). However, the polarity convention of most RS485 devices uses the opposite convention. That is, with no transmission on the bus, the receiver reports a logic value that would result if A were higher than B—in this case a high on RO. From a practical standpoint, this means that if a general RS485 transceiver is connected to a PROFIBUS network, the transceiver's A pin must connect to the B wire and the B pin connect to the A wire. Certainly this can be confusing!

Since the LTC2876/LTC2877 was designed specifically for PROFIBUS applications, the pin naming convention was made to match the PROFIBUS specification. To avoid confusion with other RS485 transceivers, the prefix “P” was added, meaning “PROFIBUS.” If driver and receiver are enabled, a high level on DI, will drive the bus lines so that PB is higher than PA and the receiver will report a high level on RO.

In PROFIBUS installations, connect PB to the B wire (red) and PA to the A wire (green). For non-PROFIBUS RS485 applications, the PB pin should be connected to the A signal and PA pin should be connect to the B signal to match the convention of most other RS485 devices.

PROFIBUS CABLES

It is recommended that PROFIBUS installations use cable designed for PROFIBUS applications. Typically, Type A cable and termination is used. This is a shielded twisted pair with the following properties:

Table 1. PROFIBUS Type-A Cable Properties

PROPERTY	VALUE
Impedance	135Ω to 165Ω
Capacitance	< 30pF/m
Loop Resistance	< 110Ω/km
Conductor Area	≥ 0.34mm ²
Color of Sheath (Non-IS)	Violet
Color of Inner Conductor A	Green
Color of Inner Conductor B	Red

The three resistors that make up the termination network should be placed at both ends of the bus and must be powered during operation. If there are multiple nodes communicating on the bus, only the nodes at the ends should be terminated.

The cable shield helps to improve electromagnetic compatibility (EMC). It is recommended to ground both ends of the shield, through the case of the connector, to the chassis of the connected station. In applications where ground potential differences exist between stations, for example long distance transmission between buildings, the shield should be grounded only at one end of the cable. If the potential difference exceeds several volts, galvanic isolation is recommended at one or more of the connected stations. In this case, consider using the LTM[®]2892 μModule isolator (see 3500V_{RMS} Isolated PROFIBUS Node with Termination on the last page).

If the shield cannot be grounded through the connector case, pin 1 of the D-sub connector can be used as an alternative, although the added inductance makes this sub-optimal. In such a case, it is better to bare the cable shield at an appropriate point and ground it with a short cable or clamp to the metallic structure of the station.

Unshielded cable can be used in PROFIBUS installations if there is no severe electromagnetic interference (EMI). Do not use cables that are untwisted pairs.

APPLICATIONS INFORMATION

MAXIMUM PROFIBUS CABLE LENGTH

The following table gives the maximum cable segment lengths at PROFIBUS baud rates, as specified in IEC 61158-2:

Table 2. PROFIBUS Maximum Cable Length

BAUD RATE (kbits/s)	MAX. SEGMENT LENGTH (m)
9.6	1200
19.2	1200
45.45	1200
93.75	1200
187.5	1000
500	400
1500	200
3000	100
6000	100
12000	100

CONNECTORS

The PROFIBUS standard only specifies the use of a 9-pin D-sub connector for stations and cables. A commonly used alternative is the 5-pin “B-coded” M12 circular connectors (IEC 947-5-2). In all cases, the female side of the connector is located in the station, while the cable uses the male end. Connector diagrams are shown in Figure 17 and pin designations are shown in Table 3.



Figure 17. Connector Pin Allocations

The D-sub connector is specified for use up to 12Mbps. Inductors are often built into the cable connectors to reduce unwanted ringing and reflections at data rates above 1.5Mbps/s. Cable connectors are also available with termination resistors that can be switched in/out.

Table 3. Pin Designation For D-Sub and M12 Connectors. (Connections in Bold are Mandatory)

PIN NUMBER		CONNECTION
9-PIN D-Sub	M12	
1, Case	Thread	Cable Shield
2		GND for 24V Supply
3	4	PB (B – Red Wire)
4		CNTR-P (Repeater Direction Control)
5	3	GND for Bus Termination
6	1	V_{CC} (+5V) for Bus Termination
7		+24V Supply
8	2	PA (A – Green Wire)
9		CNTR-N (Repeater Direction Control)
	5	Not Used

OPERATION IN RS485 AND RS422 SYSTEMS

The LTC2876 and LTC2877 are completely compatible with standard RS485 and RS422 networks. In these installations, the PB pin should be treated as the A pin for compatibility with most RS485 transceivers. Likewise, the PA pin should be matched up with the B signal in RS485. Further discussion about this can be found in section “Bus Pins PA and PB Naming Convention.”

Twisted pair cables with characteristic impedance of 120Ω or 100Ω can be used. Shielded cable is recommended for the highest electromagnetic compatibility (EMC), but unshielded cable like CAT-5e works well. Untwisted pair cables (UTP) should be avoided. Both ends of a cable should be terminated differentially with resistors that match the cable’s impedance, as illustrated in Figure 10.

Sometimes bus biasing resistors are used for non-PROFIBUS RS485 installations to introduce a high level (IDLE state) on the bus when nothing is driving it. An example of such a network is shown in Figure 18¹. Here the three resistors (620Ω, 130Ω, and 620Ω) replace the single 120Ω differential resistor in one location only.

28767fa

APPLICATIONS INFORMATION



Figure 18. Using the LTC2876/LTC2877 in an RS485 Network (Not PROFIBUS) with Optional Bus Bias Resistors

Unlike PROFIBUS, the biasing network is not part of the RS485 standard. Although the LTC2876 and LTC2877 are compatible with this biasing arrangement, the internal failsafe feature eliminates the need for it, since an undriven bus triggers a failsafe condition. In extremely noisy environments the resistor biasing helps reinforce the failsafe condition.

V_L LOGIC SUPPLY

A separate logic supply pin V_L allows the LTC2877 to interface with any logic signal from 1.65V to 5.5V. All logic I/Os use V_L as their high supply. It is recommended that V_L does not exceed V_{CC} during operation. If V_L does exceed V_{CC}, no damage will occur but the V_L supply current could increase about 300μA, depending on the operating configuration and the state of the device. If V_L is not connected to V_{CC}, bypass V_L with a 0.1μF capacitor to GND. The driver is disabled and pins PB and PA are undriven when V_L or V_{CC} is grounded or disconnected.

3.3V OPERATION

The LTC2876 and LTC2877 can be used with a supply voltage as low as 3.0V in RS485 installations. Reducing the supply voltage reduces the driver output signal swing below what is specified in the RS485 standard but still produces signals much larger than the 200mV minimum signal swing required at the receiver input. A plot in the Typical Characteristics section shows the driver output signal for 3.3V and 5V supply voltages.

3.3V-powered LTC2876/LTC2877 devices can be mixed with other RS485 transceivers running from 5V on the same network as shown in Figure 20. There is no concern for the higher voltage of a 5V node overdriving the 3.3V node

due to the overvoltage-tolerant design of the LTC2876/LTC2877, as illustrated in Figure 15.

One advantage to using a lower supply voltage is reduced V_{CC} current draw. V_{CC} supply currents are roughly proportional to the applied supply voltage when the LTC2876/LTC2877 is driving loads. The Typical Characteristics section shows the typical power supply currents versus transmission rates for 3.3V and 5V supplies.

PROFIBUS installations that use the LTC2876/LTC2877 with supply voltages less than 4.5V, may fall out of compliance to the PROFIBUS specification.

HIGH SPEED CONSIDERATIONS

A ground plane layout with a 1μF bypass capacitor placed less than 7mm away from V_{CC} is recommended. The PC board traces connected to signal PB and PA should be symmetrical and as short as possible to maintain good differential signal integrity. To minimize capacitive effects, the differential signals should be separated by more than the width of a trace and should not be routed on top of each other if they are on different signal planes.

Care should be taken to route the outputs away from the sensitive inputs to reduce feedback effects that might cause noise, jitter, and even oscillations. For example, DI and RO should not be routed next to each other or next to PB and PA.

Logic inputs have a typical hysteresis of about 150mV to provide noise immunity. Fast edges on the outputs can cause glitches in the ground and power supplies which are exacerbated by capacitive loading. If a logic input is held near its threshold (typically V_{CC}/2 or V_L/2), a noise glitch from a driver transition may exceed the hysteresis levels on the logic and data input pins, causing an unintended state change. This can be avoided by maintaining normal logic levels on the pins and by slewing inputs faster than 1V/μs. Good supply decoupling and proper driver termination also reduces glitches caused by driver transitions.

REFERENCES

- 1 "Application Guidelines for TIA/EIA-485-A": TSB-89-A, TIA Telecommunications System Bulletin, January 2006.

APPLICATIONS INFORMATION



28767 F18

Figure 19. Complete Configuration for PROFIBUS Operation Using the (a) LTC2876, or (b) LTC2877 and (c) the Cable with Termination Resistors

APPLICATIONS INFORMATION

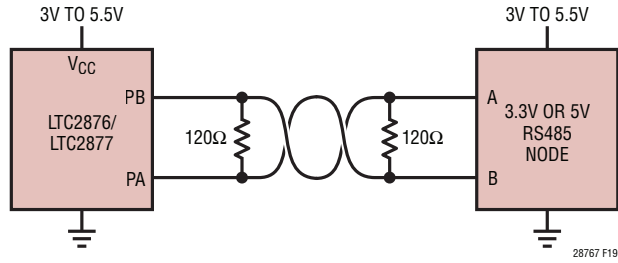

Figure 20. LTC2876/LTC2877 Operation as Low as 3V is Compatible with Other RS485 Devices, but with Reduced Output Signal Swing



Figure 21. Exceptionally Robust, Low-Capacitance, $\pm 30V$ Tolerant, $\pm 4kV$ IEC 61000 Bus Protection Against Surge, EFT, and ESD. (See Auxiliary Protection for Surge, EFT, and ESD in the Applications Information Section for More Details)

PACKAGE DESCRIPTION

Please refer to <http://www.linear.com/product/LTC2876#packaging> for the most recent package drawings.

DD Package 8-Lead Plastic DFN (3mm × 3mm) (Reference LTC DWG # 05-08-1698 Rev C)



RECOMMENDED SOLDER PAD PITCH AND DIMENSIONS
APPLY SOLDER MASK TO AREAS THAT ARE NOT SOLDERED



NOTE:

1. DRAWING TO BE MADE A JEDEC PACKAGE OUTLINE M0-229 VARIATION OF (WEED-1)
2. DRAWING NOT TO SCALE
3. ALL DIMENSIONS ARE IN MILLIMETERS
4. DIMENSIONS OF EXPOSED PAD ON BOTTOM OF PACKAGE DO NOT INCLUDE MOLD FLASH. MOLD FLASH, IF PRESENT, SHALL NOT EXCEED 0.15mm ON ANY SIDE
5. EXPOSED PAD SHALL BE SOLDER PLATED
6. SHADED AREA IS ONLY A REFERENCE FOR PIN 1 LOCATION ON TOP AND BOTTOM OF PACKAGE

PACKAGE DESCRIPTION

Please refer to <http://www.linear.com/product/LTC2876#packaging> for the most recent package drawings.

DD Package
10-Lead Plastic DFN (3mm × 3mm)
 (Reference LTC DWG # 05-08-1699 Rev C)



RECOMMENDED SOLDER PAD PITCH AND DIMENSIONS



NOTE:

1. DRAWING TO BE MADE A JEDEC PACKAGE OUTLINE M0-229 VARIATION OF (WEED-2). CHECK THE LTC WEBSITE DATA SHEET FOR CURRENT STATUS OF VARIATION ASSIGNMENT
2. DRAWING NOT TO SCALE
3. ALL DIMENSIONS ARE IN MILLIMETERS
4. DIMENSIONS OF EXPOSED PAD ON BOTTOM OF PACKAGE DO NOT INCLUDE MOLD FLASH. MOLD FLASH, IF PRESENT, SHALL NOT EXCEED 0.15mm ON ANY SIDE
5. EXPOSED PAD SHALL BE SOLDER PLATED
6. SHADED AREA IS ONLY A REFERENCE FOR PIN 1 LOCATION ON THE TOP AND BOTTOM OF PACKAGE

PACKAGE DESCRIPTION

Please refer to <http://www.linear.com/product/LTC2876#packaging> for the most recent package drawings.

MS8E Package 8-Lead Plastic MSOP, Exposed Die Pad (Reference LTC DWG # 05-08-1662 Rev K)



NOTE:

1. DIMENSIONS IN MILLIMETER/(INCH)
2. DRAWING NOT TO SCALE
3. DIMENSION DOES NOT INCLUDE MOLD FLASH, PROTRUSIONS OR GATE BURRS. MOLD FLASH, PROTRUSIONS OR GATE BURRS SHALL NOT EXCEED 0.152mm (.006") PER SIDE
4. DIMENSION DOES NOT INCLUDE INTERLEAD FLASH OR PROTRUSIONS. INTERLEAD FLASH OR PROTRUSIONS SHALL NOT EXCEED 0.152mm (.006") PER SIDE
5. LEAD COPLANARITY (BOTTOM OF LEADS AFTER FORMING) SHALL BE 0.102mm (.004") MAX
6. EXPOSED PAD DIMENSION DOES INCLUDE MOLD FLASH. MOLD FLASH ON E-PAD SHALL NOT EXCEED 0.254mm (.010") PER SIDE.

PACKAGE DESCRIPTION

Please refer to <http://www.linear.com/product/LTC2876#packaging> for the most recent package drawings.

MSE Package 10-Lead Plastic MSOP, Exposed Die Pad (Reference LTC DWG # 05-08-1664 Rev I)



REVISION HISTORY

REV	DATE	DESCRIPTION	PAGE NUMBER
A	08/16	Changed test condition for t_{PLHR} and t_{PHLR}	5

LTC2876/LTC2877

TYPICAL APPLICATION

3500V_{RMS} Isolated PROFIBUS Node with Termination



28767 TA02

RELATED PARTS

PART NUMBER	DESCRIPTION	COMMENTS
LTC2862/LTC2863/LTC2864/LTC2865	±60V Fault Protected 3V to 5.5V RS485/RS422 Transceivers	±60V Tolerant, ±15kV ESD, 250kbps or 20Mbps
LTC2856/LTC2857/LTC2858	5V 20Mbps and Slew Rate Limited 15kV RS485/RS422 Transceivers	±15kV ESD, 250kbps or 20Mbps
LTC2850/LTC2851/LTC2852	3.3V 20Mbps RS485 Transceivers	±15kV ESD
LTC2854/LTC2855	3.3V 20Mbps RS485 Transceivers with Integrated Switchable Termination	±25kV ESD (LTC2854), ±15kV ESD (LTC2855)
LTC2859, LTC2861	5V 20Mbps and Slew Rate Limited RS485 Transceivers	±15kV ESD
LTM2881	Complete 3.3V or 5V Isolated RS485 μModule Transceiver + Power, and Switchable Integrated Termination Resistor	2500V _{RMS} Isolation, with Integrated Isolated DC/DC Converter, 1W Power, Low EMI, ±15kV ESD, 30kV/μs Transient Immunity
LTM2892	3500V _{RMS} 6-Channel Digital Isolator	3500V _{RMS} Isolation in a Small Package with Temperature Ratings Up to 125°C

28767fa

Данный компонент на территории Российской Федерации

Вы можете приобрести в компании MosChip.

Для оперативного оформления запроса Вам необходимо перейти по данной ссылке:

<http://moschip.ru/get-element>

Вы можете разместить у нас заказ для любого Вашего проекта, будь то серийное производство или разработка единичного прибора.

В нашем ассортименте представлены ведущие мировые производители активных и пассивных электронных компонентов.

Нашей специализацией является поставка электронной компонентной базы двойного назначения, продукции таких производителей как XILINX, Intel (ex.ALTERA), Vicor, Microchip, Texas Instruments, Analog Devices, Mini-Circuits, Amphenol, Glenair.

Сотрудничество с глобальными дистрибьюторами электронных компонентов, предоставляет возможность заказывать и получать с международных складов практически любой перечень компонентов в оптимальные для Вас сроки.

На всех этапах разработки и производства наши партнеры могут получить квалифицированную поддержку опытных инженеров.

Система менеджмента качества компании отвечает требованиям в соответствии с ГОСТ Р ИСО 9001, ГОСТ РВ 0015-002 и ЭС РД 009

Офис по работе с юридическими лицами:

105318, г.Москва, ул.Щербаковская д.3, офис 1107, 1118, ДЦ «Щербаковский»

Телефон: +7 495 668-12-70 (многоканальный)

Факс: +7 495 668-12-70 (доб.304)

E-mail: info@moschip.ru

Skype отдела продаж:

moschip.ru

moschip.ru_4

moschip.ru_6

moschip.ru_9