

**Force Guided Relay on DIN-rail SR6 Z**

- 6 pole relay with force guided contacts according to EN50205
- DIN rail mounting
- AC / DC input

Typical applications  
contact monitoring in railway, elevator and machine controls



Approvals	
relay SR6:	VDE, UL, TUV, CQC
module SR6Z:	CE
Technical data of approved types on request	

Contact Data	
Contact arrangement	3 form A (NO) and 3 form B (NC), 4 form A (NO) and 2 form B (NC), 5 form A (NO) and 1 form B (NC)
Rated voltage	250VAC
Max. switching voltage	250VAC
Rated current	8A
Contact material	AgSnO <sub>2</sub>
Contact style	single contact, force guided type A according to EN 50205
Min. recommended contact load	5V, 10mA
Initial contact resistance	≤100mΩ at 1A, 24VDC ≤20Ω at 10mA, 5VDC
Frequency of operation, with/without load	6/150min <sup>-1</sup>
Contact ratings, IEC60947-5-1, on 1 form A (NO) contact	AC15-5A DC13-6A
Mechanical endurance	10x10 <sup>6</sup> operations

Coil Data	
Coil voltage range	6 to 115 VAC/VDC, 230VAC
DC energizing voltage U <sub>rtid</sub>	6, 12, 18, 21, 24, 36, 40, 48, 60, 115VDC
AC/DC energizing voltage U <sub>rtid</sub>	24, 115VAC/VDC
AC energizing voltage U <sub>rtid</sub>	230VAC
Operative range	90 to 110% of U <sub>rtid</sub>
Release voltage (+23°C)	10% of U <sub>rtid</sub>
Max. coil power DC versions	1200mW
Max. system power AC/DC versions	2400mVA

Insulation Data	
Initial dielectric strength	
between open contacts	1000V <sub>rms</sub>
between contact and coil	3000V <sub>rms</sub>
between adjacent contacts	2000V <sub>rms</sub>
Clearance/creepage	
between open contacts	microdisconnection
between contact and coil	≥5.5/5.5mm
between adjacent contacts	≥2,8 /2.8mm
Insulation to EN 50178, type of insulation	
between contact and coil	reinforced
between adjacent contacts	basic

Other Data	
Material compliance: EU RoHS/ELV, China RoHS, REACH, Halogen content refer to the Product Compliance Support Center at <a href="http://www.te.com/customer-support/rohssupportcenter">www.te.com/customer-support/rohssupportcenter</a>	

Ambient temperature	
for mounting/handling	0 to 40°C
in operation	-25 to 50°C
SR6ZC 730 only	-25 to 40°C
Terminal type	screwless clamp connectors
Wire cross section	
solid wire	2.5mm <sup>2</sup>
stranded wire	2.5mm <sup>2</sup>
stranded wire with bootlace crimp	1.5mm <sup>2</sup>
Mounting position	any
Weight	90g
Packaging unit	2

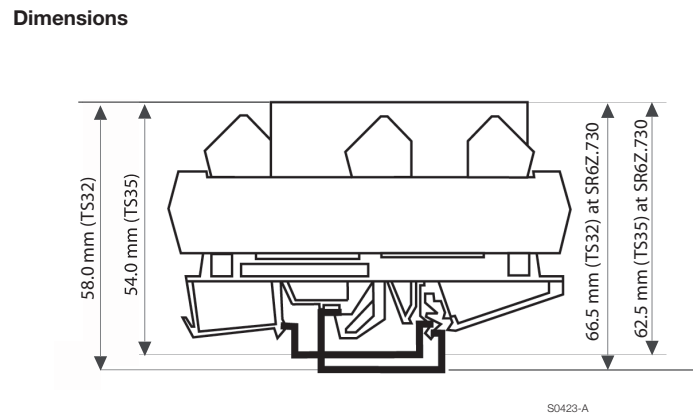

Module width 46 mm  
Module length 87 mm  
Fit onto mounting rails according to DIN EN 60175

**Force Guided Relay on DIN-rail SR6 Z (Continued)**

**Terminal assignment**

DC module, 4 NO+2 NC version

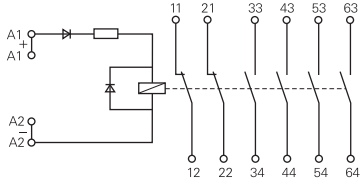

DC module, 3 NO+3 NC version

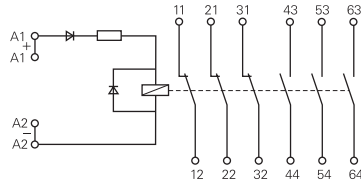

DC module, 5 NO+1 NC version

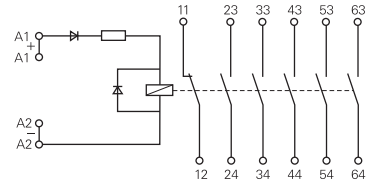

AC/DC module, 4 NO+2 NC version



S0422-BD

AC/DC module, 3 NO+3 NC version

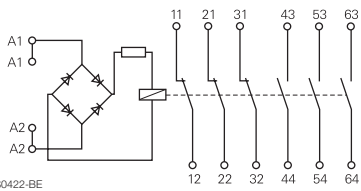

S0422-BE

AC/DC module, 5 NO+1 NC version

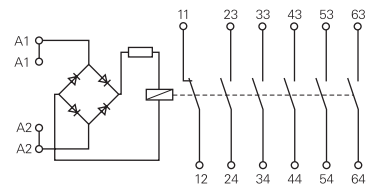

S0422-BF

SR6ZA...

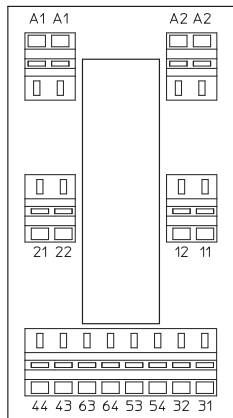

SR6ZB...

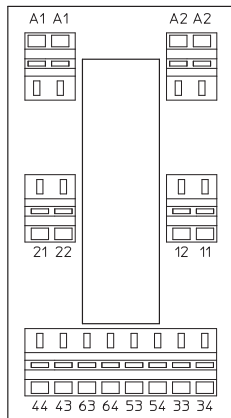

SR6ZC...

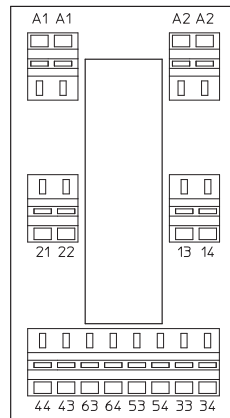

S6Z8004

**Product code structure**

Typical product code **SR6Z B 024**

**Type**  
SR6Z Relay with force guided contacts on DIN-rail SR6 Z

- Contact configuration**
- A 3 form A (NO) + 3 form B (NC) contacts
  - B 4 form A (NO) + 2 form B (NC) contacts
  - C 5 form A (NO) + 1 form B (NC) contacts

**Coil**  
DC Coil code = rated coil voltage (e.g. 024=24 VDC)  
AC/DC coil code: 524=24 VAC/VDC, 615=115 VAC/VDC  
AC coil code: 730=230 VAC

Other types on request

Product code	Type	Contact configuration	Contact material	Coil	Part number
SR6ZA024	6-pole	3 form A + 3 form B	AgSnO <sub>2</sub>	24VDC	7-1415033-1
SR6ZA524	force guided relay module	3 NO + 3 NC contacts		24VAC/VDC	9-1415059-1
SR6ZA615				115VAC/VDC	1415060-1
SR6ZA730				230VAC	1-1415060-1
SR6ZB024		4 form A + 2 form B		24VDC	5-1415033-1
SR6ZB524				24VAC/VDC	2-1415060-1
SR6ZB615				115VAC/VDC	6-1415046-1
SR6ZB730				230VAC	3-1415060-1
SR6ZC024		5 form A + 1 form B		24VDC	3-1415042-1
SR6ZC524				24VAC/VDC	4-1415060-1
SR6ZC615				115VAC/VDC	5-1415060-1
SR6ZC730				230VAC	6-1415060-1

## Данный компонент на территории Российской Федерации

### Вы можете приобрести в компании MosChip.

Для оперативного оформления запроса Вам необходимо перейти по данной ссылке:

<http://moschip.ru/get-element>

Вы можете разместить у нас заказ для любого Вашего проекта, будь то серийное производство или разработка единичного прибора.

В нашем ассортименте представлены ведущие мировые производители активных и пассивных электронных компонентов.

Нашей специализацией является поставка электронной компонентной базы двойного назначения, продукции таких производителей как XILINX, Intel (ex.ALTERA), Vicor, Microchip, Texas Instruments, Analog Devices, Mini-Circuits, Amphenol, Glenair.

Сотрудничество с глобальными дистрибьюторами электронных компонентов, предоставляет возможность заказывать и получать с международных складов практически любой перечень компонентов в оптимальные для Вас сроки.

На всех этапах разработки и производства наши партнеры могут получить квалифицированную поддержку опытных инженеров.

Система менеджмента качества компании отвечает требованиям в соответствии с ГОСТ Р ИСО 9001, ГОСТ РВ 0015-002 и ЭС РД 009

### Офис по работе с юридическими лицами:

105318, г.Москва, ул.Щербаковская д.3, офис 1107, 1118, ДЦ «Щербаковский»

Телефон: +7 495 668-12-70 (многоканальный)

Факс: +7 495 668-12-70 (доб.304)

E-mail: [info@moschip.ru](mailto:info@moschip.ru)

Skype отдела продаж:

moschip.ru

moschip.ru\_4

moschip.ru\_6

moschip.ru\_9