

# HiPerFAST™ IGBT

**IXGH 15N120B**  
**IXGT 15N120B**

**$V_{CES}$  = 1200 V**  
 **$I_{C25}$  = 30 A**  
 **$V_{CE(sat)}$  = 3.2 V**  
 **$t_{fi(typ)}$  = 160 ns**

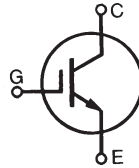

Symbol	Test Conditions	Maximum Ratings	
$V_{CES}$	$T_J = 25^\circ\text{C}$ to $150^\circ\text{C}$	1200	V
$V_{CGR}$	$T_J = 25^\circ\text{C}$ to $150^\circ\text{C}$ ; $R_{GE} = 1\text{ M}\Omega$	1200	V
$V_{GES}$	Continuous	$\pm 20$	V
$V_{GEM}$	Transient	$\pm 30$	V
$I_{C25}$	$T_C = 25^\circ\text{C}$	30	A
$I_{C110}$	$T_C = 110^\circ\text{C}$	15	A
$I_{CM}$	$T_C = 25^\circ\text{C}$ , 1 ms	60	A
<b>SSOA (RBSOA)</b>	$V_{GE} = 15\text{ V}$ , $T_{VJ} = 125^\circ\text{C}$ , $R_G = 10\ \Omega$ Clamped inductive load	$I_{CM} = 40$ @ $0.8 V_{CES}$	A
$P_C$	$T_C = 25^\circ\text{C}$	180	W
$T_J$		-55 ... +150	$^\circ\text{C}$
$T_{JM}$		150	$^\circ\text{C}$
$T_{stg}$		-55 ... +150	$^\circ\text{C}$
Maximum Lead temperature for soldering		300	$^\circ\text{C}$
1.6 mm (0.062 in.) from case for 10 s			
Maximum Tab temperature for soldering SMD devices for 10 s		260	$^\circ\text{C}$
$M_d$	Mounting torque (M3)	1.13/10Nm/lb.in.	
<b>Weight</b>	TO-247 AD	6	g
	TO-268	4	g

**TO-268 (IXGT)**

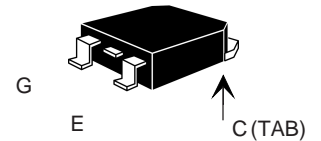

**TO-247 AD (IXGH)**

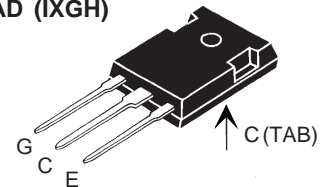

G = Gate, C = Collector,  
E = Emitter, TAB = Collector

## Features

- International standard packages JEDEC TO-268 surface and JEDEC TO-247 AD
- Low switching losses, low  $V_{(sat)}$
- MOS Gate turn-on - drive simplicity

## Applications

- AC motor speed control
- DC servo and robot drives
- DC choppers
- Uninterruptible power supplies (UPS)
- Switched-mode and resonant-mode power supplies

## Advantages

- High power density
- Suitable for surface mounting
- Easy to mount with 1 screw, (isolated mounting screw hole)

Symbol	Test Conditions	Characteristic Values ( $T_J = 25^\circ\text{C}$ , unless otherwise specified)		
		min.	typ.	max.
$BV_{CES}$	$I_C = 250\ \mu\text{A}$ , $V_{GE} = 0\text{ V}$	1200		V
$V_{GE(th)}$	$I_C = 250\ \mu\text{A}$ , $V_{CE} = V_{GE}$	2.5		V
$I_{CES}$	$V_{CE} = V_{CES}$ $V_{GE} = 0\text{ V}$	$T_J = 25^\circ\text{C}$		100 $\mu\text{A}$
		$T_J = 125^\circ\text{C}$		3.5 mA
$I_{GES}$	$V_{CE} = 0\text{ V}$ , $V_{GE} = \pm 20\text{ V}$			$\pm 100\text{ nA}$
$V_{CE(sat)}$	$I_C = I_{C90}$ , $V_{GE} = 15\text{ V}$		2.5	3.2 V
	$T_J = 125^\circ\text{C}$			V

Symbol	Test Conditions	Characteristic Values ( $T_J = 25^\circ\text{C}$ , unless otherwise specified)			
		min.	typ.	max.	
$g_{fs}$	$I_C = I_{C110}; V_{CE} = 10\text{ V}$ , Pulse test, $t \leq 300\ \mu\text{s}$ , duty cycle $\leq 2\%$	12	15	S	
$C_{ies}$	$V_{CE} = 25\text{ V}, V_{GE} = 0\text{ V}, f = 1\text{ MHz}$		1720	pF	
$C_{oes}$			95	pF	
$C_{res}$			35	pF	
$Q_g$	$I_C = I_{C110}, V_{GE} = 15\text{ V}, V_{CE} = 0.5 V_{CES}$		69	nC	
$Q_{ge}$			13	nC	
$Q_{gc}$			26	nC	
$t_{d(on)}$	<b>Inductive load, <math>T_J = 25^\circ\text{C}</math></b> $I_C = I_{C110}, V_{GE} = 15\text{ V}$ $V_{CE} = 0.8 V_{CES}, R_G = R_{off} = 10\ \Omega$ Remarks: Switching times may increase for $V_{CE}(\text{Clamp}) > 0.8 \cdot V_{CES}$ , higher $T_J$ or increased $R_G$		25	ns	
$t_{ri}$			15	ns	
$t_{d(off)}$			180	280	ns
$t_{fi}$			160	320	ns
$E_{off}$			1.75	3.0	mJ
$t_{d(on)}$	<b>Inductive load, <math>T_J = 125^\circ\text{C}</math></b> $I_C = I_{C110}, V_{GE} = 15\text{ V}$ $V_{CE} = 0.8 V_{CES}, R_G = R_{off} = 10\ \Omega$ Remarks: Switching times may increase for $V_{CE}(\text{Clamp}) > 0.8 \cdot V_{CES}$ , higher $T_J$ or increased $R_G$		25	ns	
$t_{ri}$			18	ns	
$E_{on}$			0.60		mJ
$t_{d(off)}$			300		ns
$t_{fi}$			360		ns
$E_{off}$		3.5		mJ	
$R_{thJC}$				0.65 K/W	
$R_{thCK}$	(TO-247)		0.25	K/W	

### Min Recommended Footprint

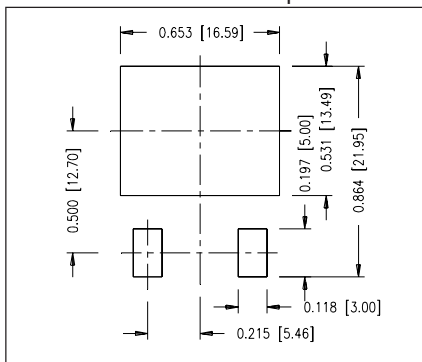

### TO-247 AD Outline

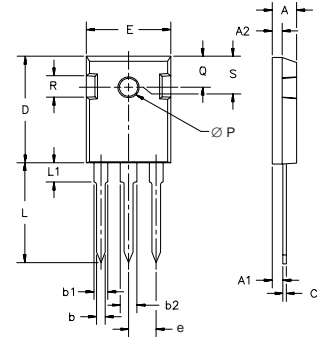

Dim.	Millimeter		Inches	
	Min.	Max.	Min.	Max.
A	4.7	5.3	.185	.209
A <sub>1</sub>	2.2	2.54	.087	.102
A <sub>2</sub>	2.2	2.6	.059	.098
b	1.0	1.4	.040	.055
b <sub>1</sub>	1.65	2.13	.065	.084
b <sub>2</sub>	2.87	3.12	.113	.123
C	.4	.8	.016	.031
D	20.80	21.46	.819	.845
E	15.75	16.26	.610	.640
e	5.20	5.72	0.205	0.225
L	19.81	20.32	.780	.800
L1		4.50		.177
∅P	3.55	3.65	.140	.144
Q	5.89	6.40	0.232	0.252
R	4.32	5.49	.170	.216
S	6.15	BSC	242	BSC

### TO-268 Outline

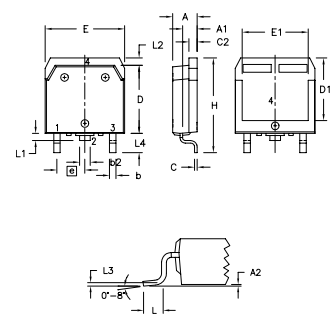

Dim.	Millimeter		Inches	
	Min.	Max.	Min.	Max.
A	4.9	5.1	.193	.201
A <sub>1</sub>	2.7	2.9	.106	.114
A <sub>2</sub>	.02	.25	.001	.010
b	1.15	1.45	.045	.057
b <sub>1</sub>	1.9	2.1	.75	.83
C	.4	.65	.016	.026
D	13.80	14.00	.543	.551
E	15.85	16.05	.624	.632
E <sub>1</sub>	13.3	13.6	.524	.535
e	5.45	BSC	.215	BSC
H	18.70	19.10	.736	.752
L	2.40	2.70	.094	.106
L1	1.20	1.40	.047	.055
L2	1.00	1.15	.039	.045
L3		0.25		.010 BSC
L4	3.80	4.10	.150	.161

IXYS reserves the right to change limits, test conditions, and dimensions.

IXYS MOSFETs and IGBTs are covered by one or more of the following U.S. patents:

4,835,592	4,881,106	5,017,508	5,049,961	5,187,117	5,486,715	6,306,728B1
4,850,072	4,931,844	5,034,796	5,063,307	5,237,481	5,381,025	

Fig. 1. Saturation Voltage Characteristics @ 25°C

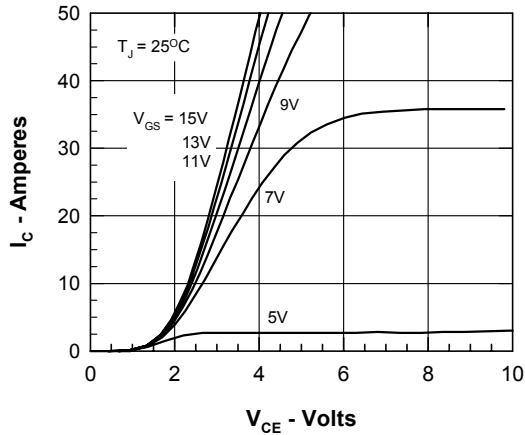

Fig. 2. Extended Output Characteristics

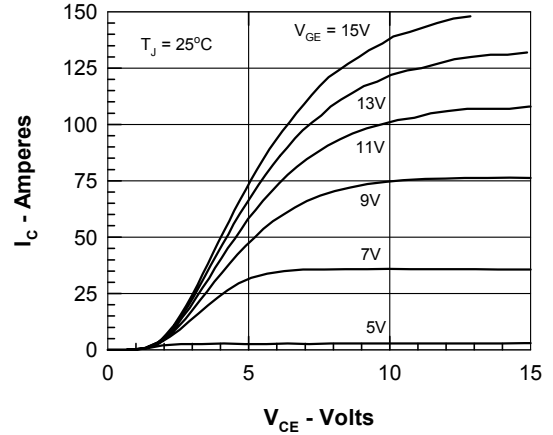

Fig. 3. Saturation Voltage Characteristics @ 125°C

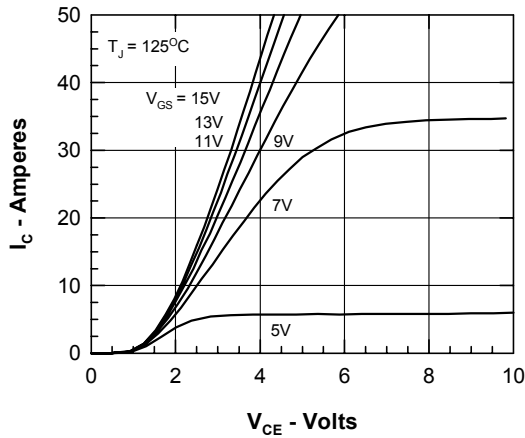

Fig. 4. Temperature Dependence of  $V_{CE(SAT)}$

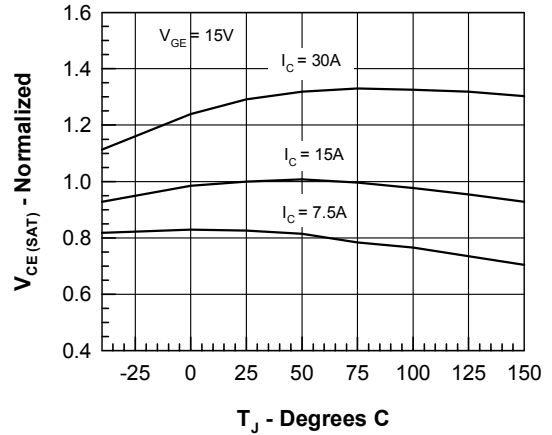

Fig. 5. Admittance Curves

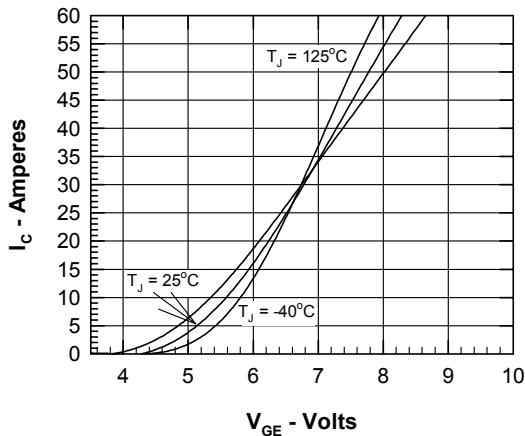

Fig. 6. Capacitance Curves

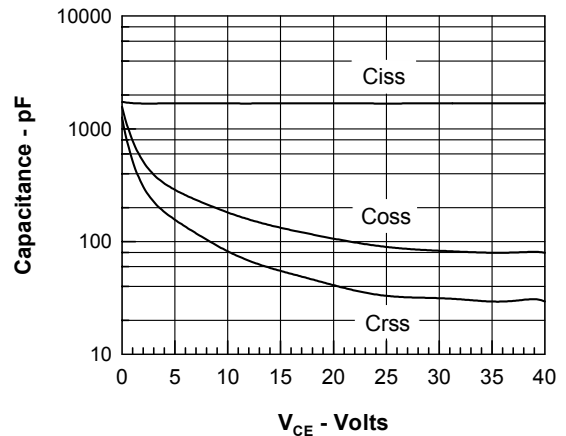

Fig. 7. Dependence of  $E_{OFF}$  on  $I_C$ .

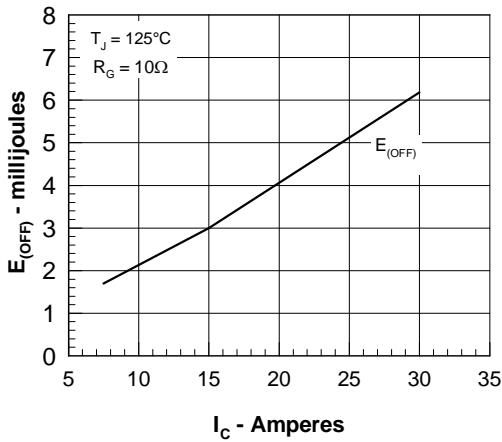

Fig. 8. Dependence of  $E_{OFF}$  on  $R_G$ .

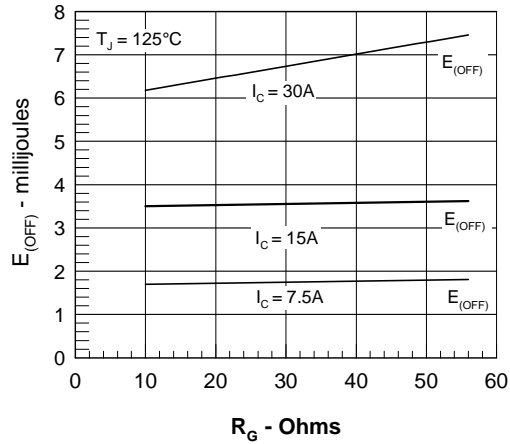

Fig. 9. Gate Charge

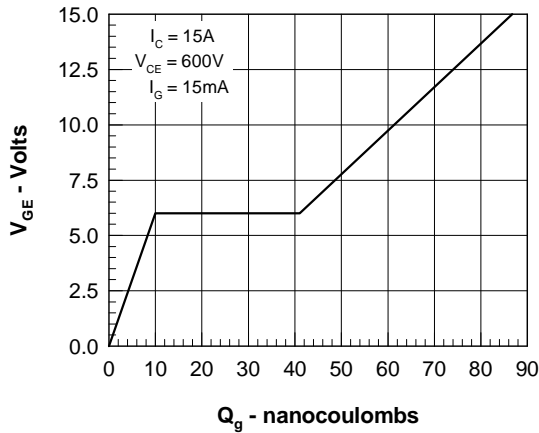

Fig. 10. Turn-off Safe Operating Area

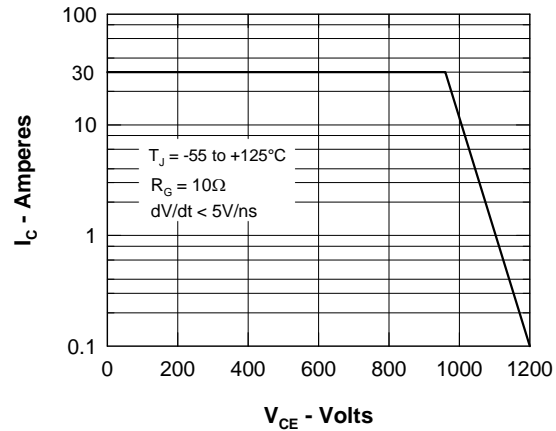
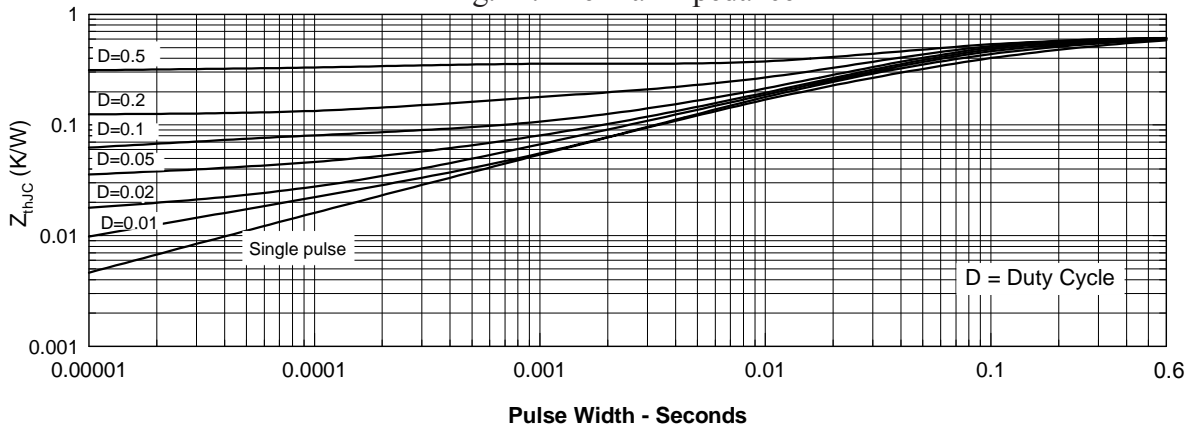

Fig. 11. Thermal Impedance



## Данный компонент на территории Российской Федерации

### Вы можете приобрести в компании MosChip.

Для оперативного оформления запроса Вам необходимо перейти по данной ссылке:

<http://moschip.ru/get-element>

Вы можете разместить у нас заказ для любого Вашего проекта, будь то серийное производство или разработка единичного прибора.

В нашем ассортименте представлены ведущие мировые производители активных и пассивных электронных компонентов.

Нашей специализацией является поставка электронной компонентной базы двойного назначения, продукции таких производителей как XILINX, Intel (ex.ALTERA), Vicor, Microchip, Texas Instruments, Analog Devices, Mini-Circuits, Amphenol, Glenair.

Сотрудничество с глобальными дистрибьюторами электронных компонентов, предоставляет возможность заказывать и получать с международных складов практически любой перечень компонентов в оптимальные для Вас сроки.

На всех этапах разработки и производства наши партнеры могут получить квалифицированную поддержку опытных инженеров.

Система менеджмента качества компании отвечает требованиям в соответствии с ГОСТ Р ИСО 9001, ГОСТ РВ 0015-002 и ЭС РД 009

### Офис по работе с юридическими лицами:

105318, г.Москва, ул.Щербаковская д.3, офис 1107, 1118, ДЦ «Щербаковский»

Телефон: +7 495 668-12-70 (многоканальный)

Факс: +7 495 668-12-70 (доб.304)

E-mail: [info@moschip.ru](mailto:info@moschip.ru)

Skype отдела продаж:

moschip.ru

moschip.ru\_4

moschip.ru\_6

moschip.ru\_9