



# Technical Data Sheet

## Opto Interrupter ITR

### ITR8307/L24/TR8

#### Features

- High sensitivity
- Cut-Off visible wavelength
- Thin
- Compact
- Pb free

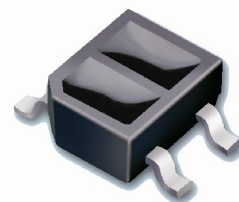

#### Descriptions

ITR8307/L24/TR8 is a light reflection switch which includes a GaAs IR-LED transmitter and a NPN photo-darlington with a high photosensitive receiver for short distance, operating in the infrared range. Both components are mounted side-by-side in a plastic package.

#### Applications

- Camera
- VCR
- Floppy disk driver
- Cassette type recorder
- Various microcomputer control equipment

#### Device Selection Guide

Device No.	Chip Material
IR	GaAs
PT	Silicon

Package Dimensions

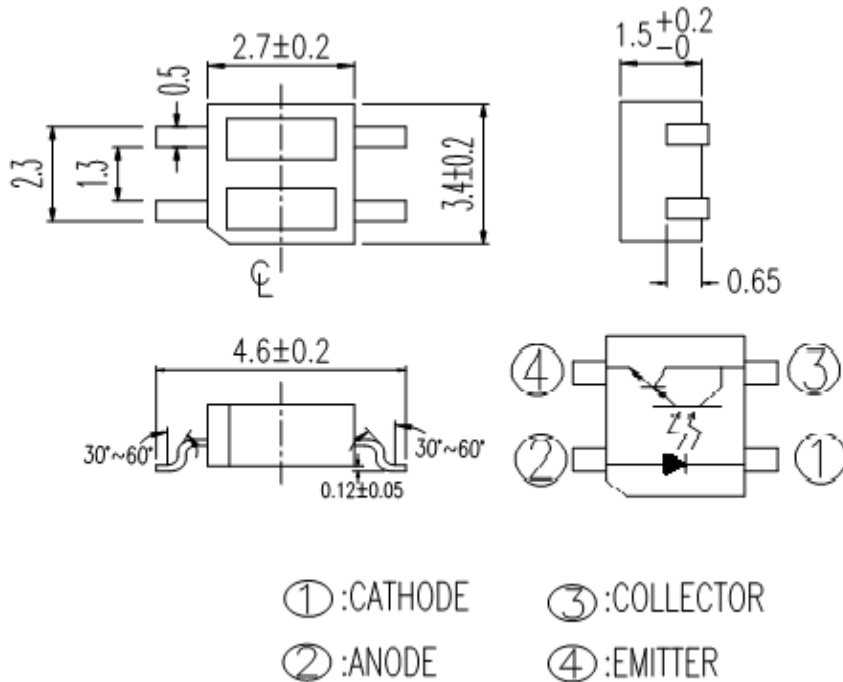

- Notes: 1.All dimensions are in millimeters
- 2.Tolerances unless dimensions ±0.25mm

Absolute Maximum Ratings (Ta=25 )

Parameter		Symbol	Ratings	Unit
Input	Power Dissipation at(or below) 25 Free Air Temperature	Pd	75	mW
	Reverse Voltage	V <sub>R</sub>	6	V
	Forward Current	I <sub>F</sub>	50	mA
	Peak Forward Current (*1) Pulse width 100µs, Duty cycle=1%	I <sub>FP</sub>	1	A
Output	Collector Power Dissipation	P <sub>C</sub>	100	mW
	Collector Current	I <sub>C</sub>	20	mA
	Collector-Emitter Voltage	B V <sub>CEO</sub>	15	V
	Emitter-Collector Voltage	B V <sub>ECO</sub>	6	V
Operating Temperature		Topr	-25~+85	
Storage Temperature		Tstg	-30~+90	
Lead Soldering Temperature (*2)		Tsol	260	

(\* 1) tw=100 µsec. , T=10 msec. (\* 2) t 10 Sec

**Electro-Optical Characteristics (Ta=25 )**

Parameter		Symbol	Min.	Typ.	Max.	Unit	Conditions
Input	Forward Voltage	$V_F$	-	1.2	1.4	V	$I_F=20mA$
	Reverse Current	$I_R$	-	-	10	$\mu A$	$V_R=6V$
	Peak Wavelength	$\lambda_P$	-	940	-	nm	-
Output	Dark Current	$I_{CEO}$	-	-	1	$\mu A$	$V_{CE}=10V,$ $E_e=0mW/cm^2$
Transfer Characteristics	Collector Current	$I_{C(ON)}^*$	0.5	-	15.0	mA	$V_{CE}=2V,$ $I_F=4mA$
	Leakage Current	$I_{CEOD}$	-	-	5	$\mu A$	$V_{CE}=2V,$ $I_F=4mA$ $d=1mm$
	Rise time	$t_r$	-	-	400	$\mu s$	$V_{CE}=2V$ $I_C=10mA$
	Fall time	$t_f$	-	-	400	$\mu s$	$R_L=100\Omega,$ $d=1mm$

\* : Reflector is Al deposited glass.

CONFIDENTIAL

**Typical Electrical/Optical/Characteristics Curves for IR**

Fig. 1 Forward Current vs. Ambient Temperature

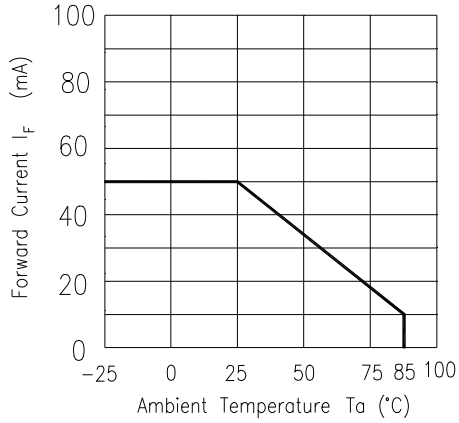

Fig. 2 Spectral Distribution

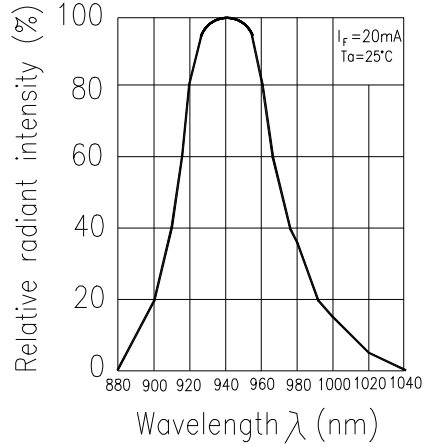

Fig. 3 Peak Emission Wavelength vs. Ambient Temperature

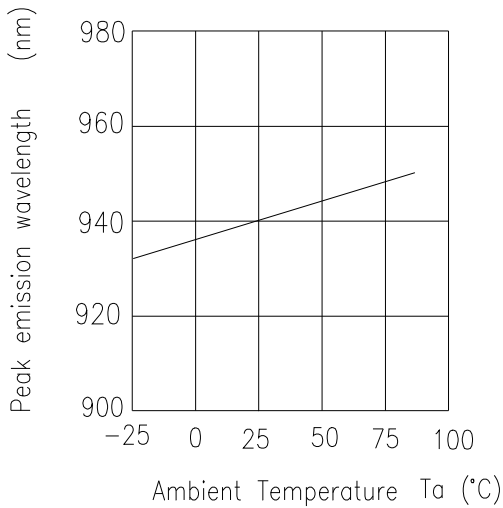

Fig. 4 Forward Current vs. Forward Voltage

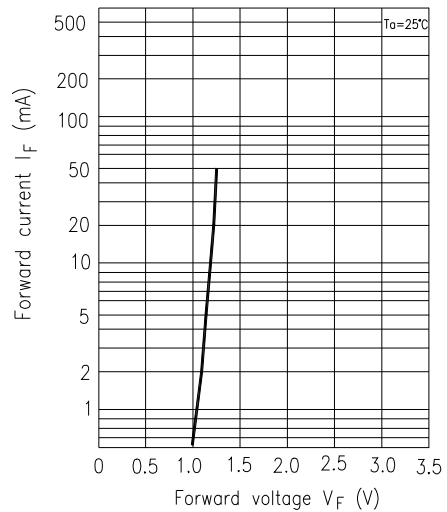

Fig. 5 Forward Voltage vs. Ambient Temperature

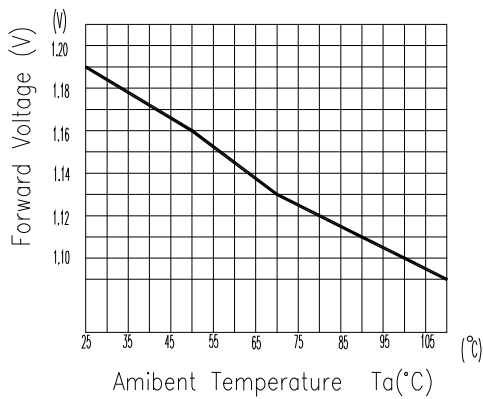
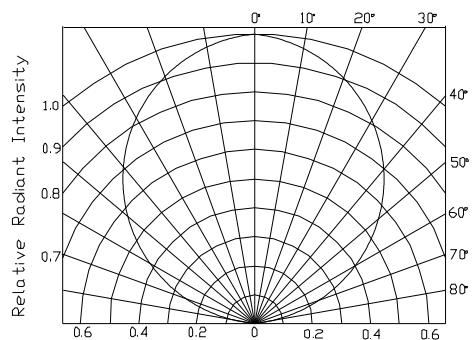
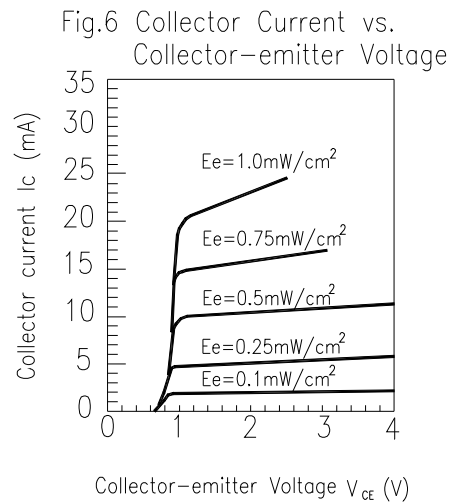
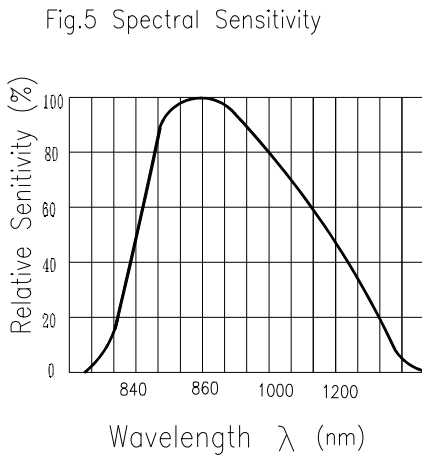
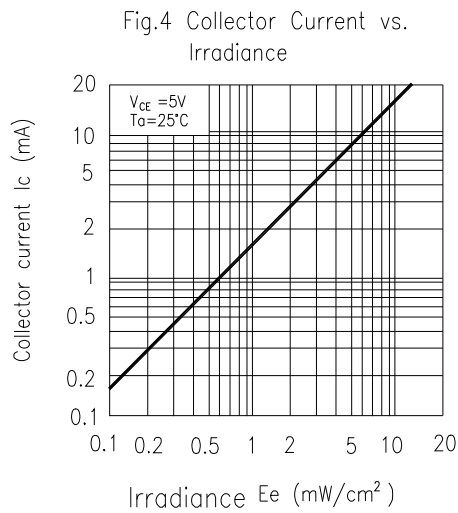
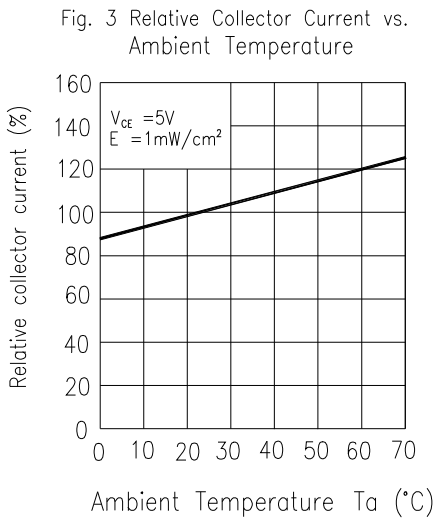
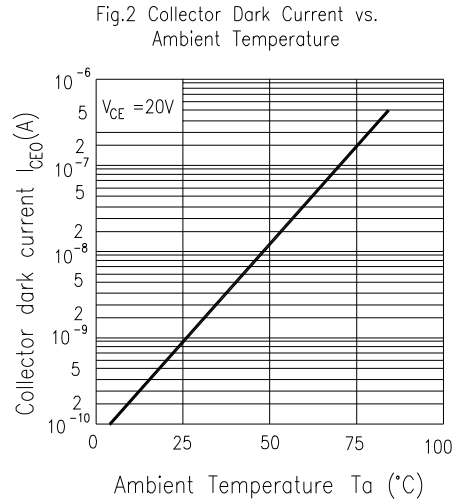
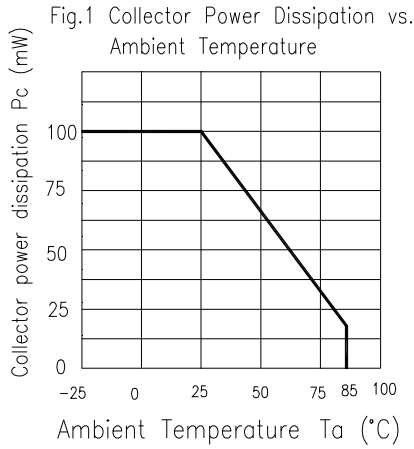

Fig. 6 Relative Radiant Intensity vs. Angular Displacement



**Typical Electrical/Optical/Characteristics Curves for PT**



**Typical Electrical/Optical/Characteristics Curves for ITR**

Fig.7 Relative Collector Current vs. Distance between Sensor and Al Evaporation Galss

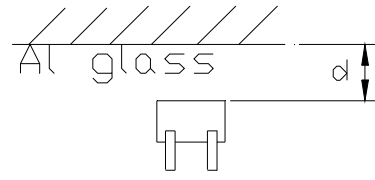
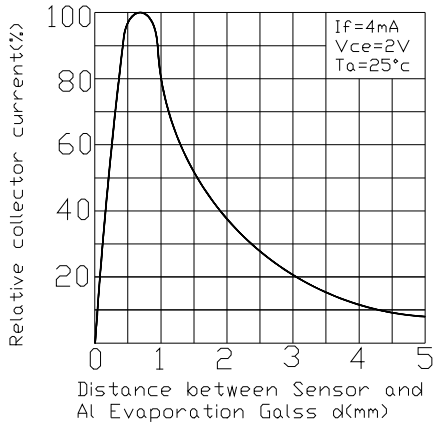
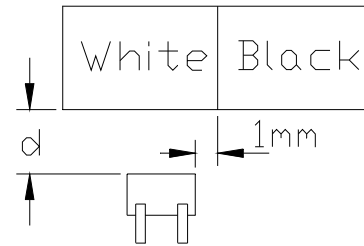
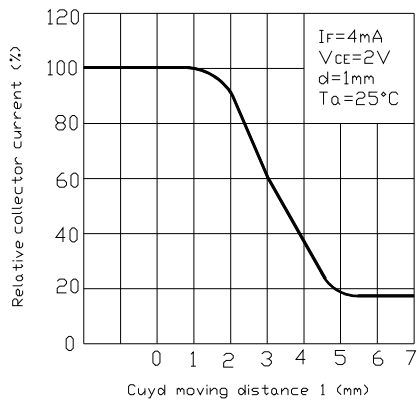

Fig.8 Relative Collector Current vs. Card Moving Distance (l)



**Reliability Test Item And Condition**

The reliability of products shall be satisfied with items listed below.

Confidence level : 90%

LTPD : 10%

NO.	Item	Test Conditions	Test Hours/ Cycles	Sample Sizes	Failure Judgement Criteria	Ac/Re
1	Solder Heat	TEMP. : 260 ±5	10secs	22pcs	I <sub>R</sub> U×2 E <sub>e</sub> L×0.8 V <sub>F</sub> U×1.2  U : Upper Specification  Limit L : Lower Specification Limit	0/1
2	Temperature Cycle	H : +85      30mins ↑ 5mins ↓ L : -25      30mins	50Cycles	22pcs		0/1
3	Thermal Shock	H : +100      5mins ↑ 10secs ↓ L : -10      5mins	50Cycles	22pcs		0/1
4	High Temperature Storage	TEMP. : +100	1000hrs	22pcs		0/1
5	Low Temperature Storage	TEMP. : -30	1000hrs	22pcs		0/1
6	DC Operating Life	I <sub>F</sub> =20mA	1000hrs	22pcs		0/1
7	High Temperature/ High Humidity	85 / 85% R.H	1000hrs	22pcs		0/1

CONFIDENTIAL

**Recommended Method of Storage**

The following are general recommendations for moisture sensitive level (MSL) 4 storage and use:

- Shelf life in sealed bag: 12 months at < 40 °C and < 90% relative humidity (RH)
- After bag is opened, devices that will be subjected to reflow solder or other high temperature process must
  - a) Mounted within 72 hours of factory conditions < 30 °C/60%RH, or
  - b) Stored at <20% RH
- Devices require bake, before mounting, if:
  - Humidity Indicator Card is > 20% when read at 23 ± 5 °C
- If baking is required, devices may be baked:
  - a) 192 hours at 40 °C, and <5% RH(dry air/nitrogen) or
  - b) 96 hours at 60 °C, and <5% RH for all device containers
  - c) 24 hours at 125 °C
- Soldering Condition
  - a) Pb-free solder temperature profile

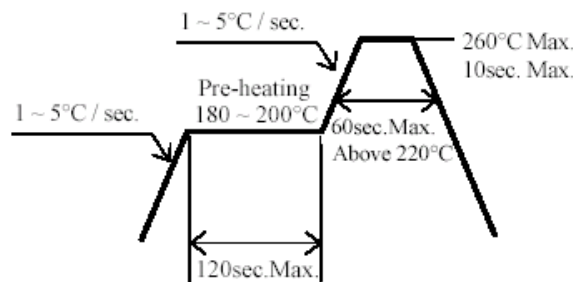

- b) Reflow soldering should not be done more than two times.
- c) When soldering, do not put stress on the LEDs during heating.
- d) After soldering, do not warp the circuit board.

● **Repairing**

Repair should not be done after the LEDs have been soldered. When repairing is unavoidable, a double-head soldering iron should be used (as below figure). It should be confirmed beforehand whether the characteristics of the LEDs will or will not be damaged by repairing.

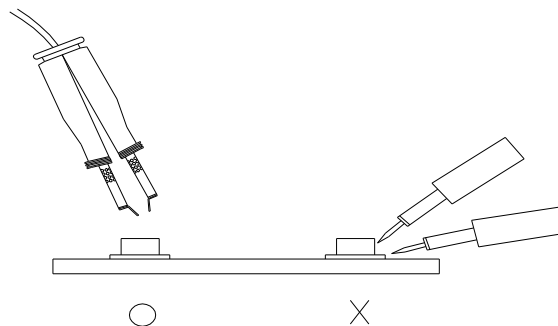



**Taping Dimension**

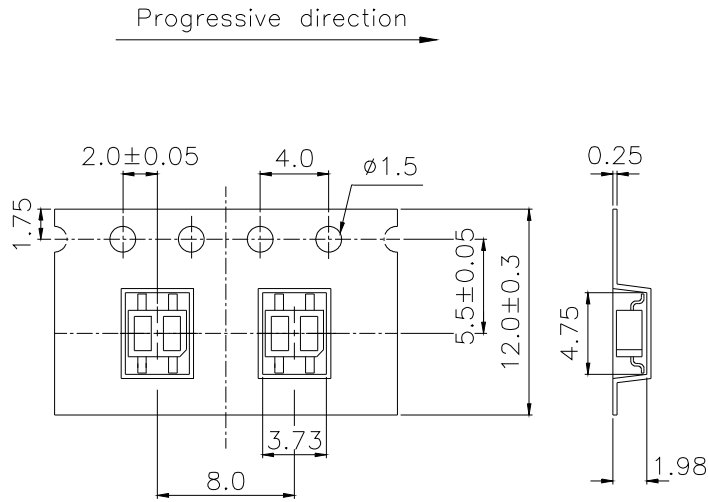

General Tolerance  $\pm 0.1$   
UNIT:mm

**Reel Dimensions**

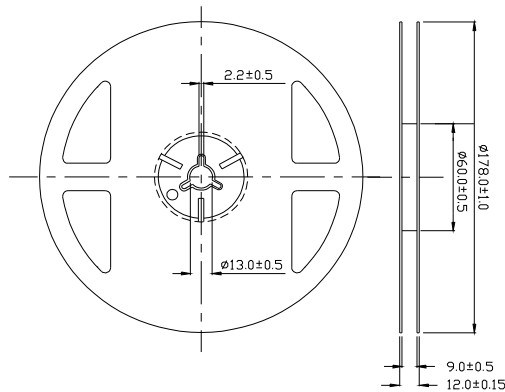

**Note:** The tolerances unless mentioned is  $\pm 0.1$ mm ,Unit = mm

**Moisture Resistant Packaging**

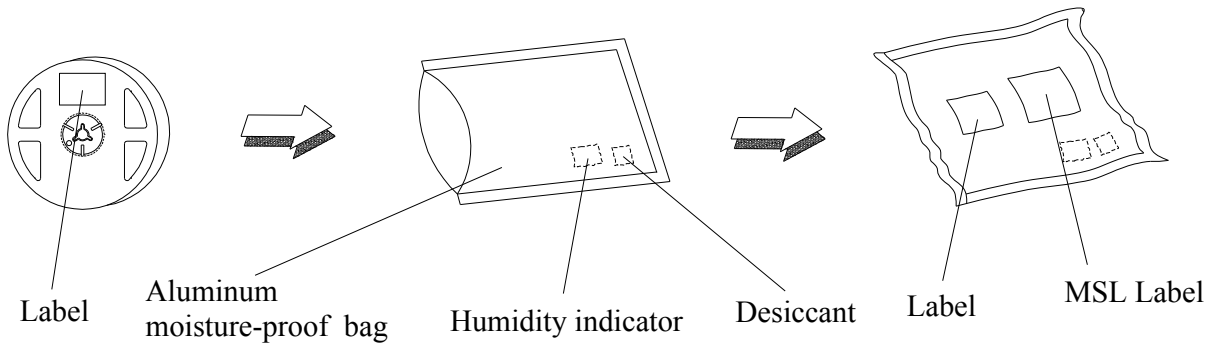

**Packing Quantity Specification**

1. 1000 Pcs/ 1Reel
2. 15 Reel /1 Box
3. 2 Box/ 1 Carton

**EVERLIGHT Label**

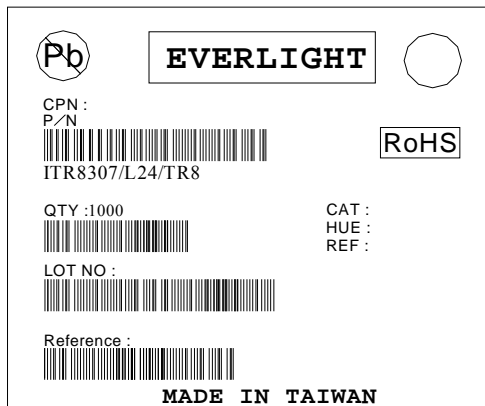

CPN: Customer's Production Number

P/N : Production Number

QTY: Packing Quantity

CAT: None

HUE: None

REF: Reference

LOT No: Lot Number

MADE IN TAIWAN: Production Place

**Notes**

1. Above specification may be changed without notice. EVERLIGHT will reserve authority on material change for above specification.
2. When using this product, please observe the absolute maximum ratings and the instructions for using outlined in these specification sheets. EVERLIGHT assumes no responsibility for any damage resulting from use of the product which does not comply with the absolute maximum ratings and the instructions included in these specification sheets.
3. These specification sheets include materials protected under copyright of EVERLIGHT corporation. Please don't reproduce or cause anyone to reproduce them without EVERLIGHT's consent.

**EVERLIGHT ELECTRONICS CO., LTD.**  
 Office: No 25, Lane 76, Sec 3, Chung Yang Rd,  
 Tucheng, Taipei 236, Taiwan, R.O.C

Tel: 886-2-2267-2000, 2267-9936  
 Fax: 886-2267-6244, 2267-6189, 2267-6306  
<http://www.everlight.com>

## Данный компонент на территории Российской Федерации

### Вы можете приобрести в компании MosChip.

Для оперативного оформления запроса Вам необходимо перейти по данной ссылке:

<http://moschip.ru/get-element>

Вы можете разместить у нас заказ для любого Вашего проекта, будь то серийное производство или разработка единичного прибора.

В нашем ассортименте представлены ведущие мировые производители активных и пассивных электронных компонентов.

Нашей специализацией является поставка электронной компонентной базы двойного назначения, продукции таких производителей как XILINX, Intel (ex.ALTERA), Vicor, Microchip, Texas Instruments, Analog Devices, Mini-Circuits, Amphenol, Glenair.

Сотрудничество с глобальными дистрибьюторами электронных компонентов, предоставляет возможность заказывать и получать с международных складов практически любой перечень компонентов в оптимальные для Вас сроки.

На всех этапах разработки и производства наши партнеры могут получить квалифицированную поддержку опытных инженеров.

Система менеджмента качества компании отвечает требованиям в соответствии с ГОСТ Р ИСО 9001, ГОСТ РВ 0015-002 и ЭС РД 009

### Офис по работе с юридическими лицами:

105318, г.Москва, ул.Щербаковская д.3, офис 1107, 1118, ДЦ «Щербаковский»

Телефон: +7 495 668-12-70 (многоканальный)

Факс: +7 495 668-12-70 (доб.304)

E-mail: [info@moschip.ru](mailto:info@moschip.ru)

Skype отдела продаж:

moschip.ru

moschip.ru\_4

moschip.ru\_6

moschip.ru\_9