

# Toggle Switch (Ultra subminiature) A9TS

## Ultra subminiature size.

- Gold-plated clip contacts ensure high reliability.
- Sealed bottom prevents flux penetration.
- Sealed to IP64 (IEC-60529). Washable with alcohol based solvents.
- 35% smaller than A9T
- Typical applications include Security Control Boards, Electric Power Instrumentation and Program Controllers.
- RoHS Compliant

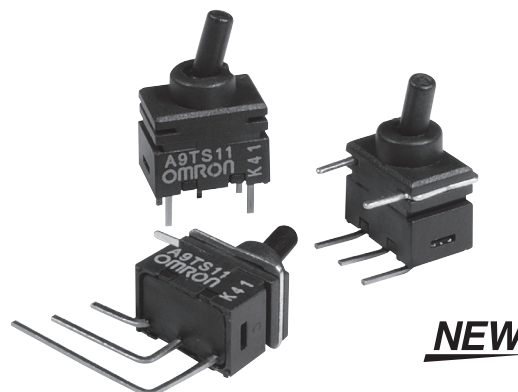

## Ordering Information

### Model Number Legend

<b>A9TS</b>	<input type="checkbox"/>	<input type="checkbox"/>	-	<b>00</b>	<input type="checkbox"/>	<input type="checkbox"/>	1.	<b>Contact Form</b>	2.	<b>Switch Function</b>	3.	<b>Actuator Style</b>	4.	<b>Terminal Style</b>
	1	2		3	4			1:		1:		1:		1:
								2:		2:				2:
														3:

### Available Models

Terminal Style			DIP Terminal, Top Actuated		Right Angle, Horizontal		Right Angle, Vertical	
Switching Function								
			Single Pole Double Throw	Double Pole Double Throw	Single Pole Double Throw	Double Pole Double Throw	Single Pole Double Throw	Double Pole Double Throw
ON	---	ON	A9TS11-0011	A9TS21-0011	A9TS11-0012	A9TS21-0012	A9TS11-0013	A9TS21-0013
ON	OFF	ON	A9TS12-0011	A9TS22-0011	A9TS12-0012	A9TS22-0012	A9TS12-0013	A9TS22-0013
Quantity per tray			100		25		50	

- Note:** 1. Lever does not stop at “-” position.  
 2. Switching functions are shown from marked side of the switch.

## Specifications

Switching capacity	100mA @ 28 VAC/VDC
Minimum Permissible Load	0.1 μA @ 20 mVAC/mVDC
Operating force	500 gf max. (4.9 N max.)
Insulation resistance	500 MΩ min. (Initial value)
Contact resistance	80 mΩ max (Initial value)
Dielectric strength	500VAC for 1 min. between terminals, between terminals and ground
Vibration resistance	Malfunction: 10 to 55Hz, 1.5-mm double amplitude
Shock resistance	Malfunction: 500m/s <sup>2</sup> min.
Life expectancy	Mechanical: 50,000 operations min. Electrical: 50,000 operations min.
Ambient operating temperature	-20 to 80°C (at 60% RH max.) with no icing or condensation
Ambient operating humidity	45% to 85% RH (at 5 to 35°C)
Weight	0.3 g

# Engineering Data

Note: Unless otherwise specified, all units are in millimeters.

## PCB Layout (Top view)

### DIP terminal

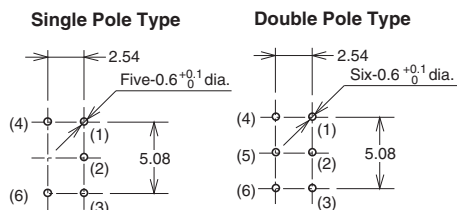

### Right Angle, Horizontal

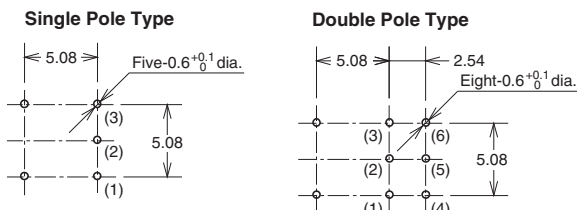

### Vertical

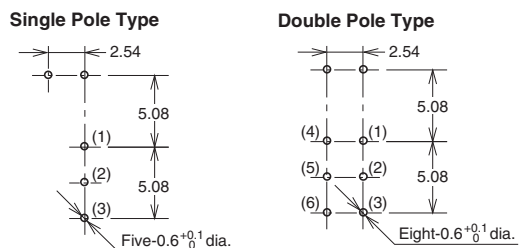

## Switching Function / Internal Connections

	Switching Functions					
SPDT Models	ON	---	ON		—	
	ON	OFF	ON			
DPDT Models	ON	---	ON		—	
	ON	OFF	ON			

Note: Lever does not stop at “-” position.

# Dimensions

## DIP terminal

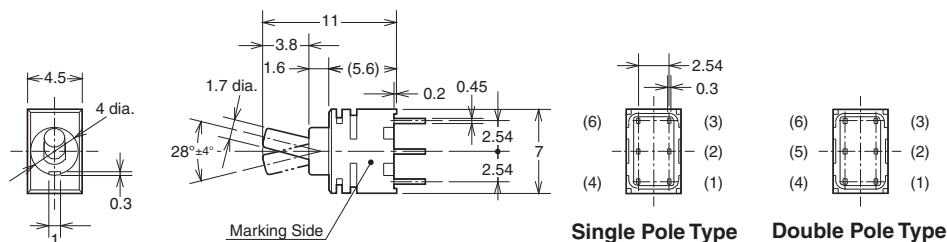

Note: NO.(4) and (6) terminals in the SPDT models are dummies to support the Switch case.

## Right Angle

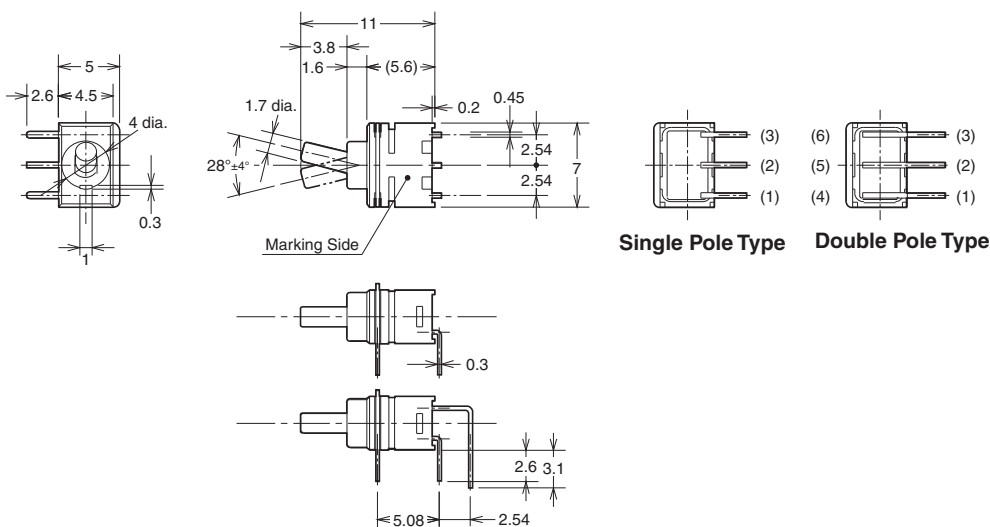
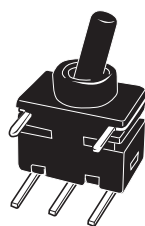

## Vertical Mount

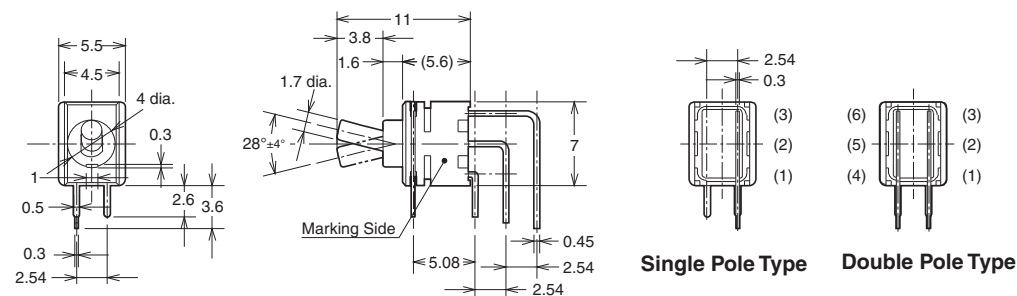
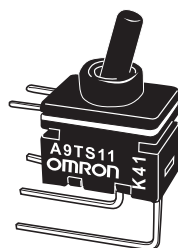

# Precautions

---

## ■ Correct Use

### Soldering

Observe the following conditions when soldering the Switch.

#### Automatic Soldering Bath

Soldering temperature: 260°C max. (Preheating: 100°C 120 s)  
Soldering time: 5 s max.

#### Manual Soldering

Soldering temperature: 350°C at the tip of the soldering iron.  
Soldering time: 3 s max.

### Washing

Apply alcohol based solvents to clean.

Do not clean the switch immediately after soldering. Wait for at least five minutes after soldering before cleaning.

Ultrasonic cleaning is not available dip into the switch washing agents for two minute maximum.

### Using Flux

Making mistakes in the type of flux or in the amount or method in which it is applied can cause flux to enter the interior of the Switch, with adverse effects on Switch performance. Assess the proper flux, conditions, and methods prior to using it.

### Environment for Storage and Use

To prevent discoloration of the terminals and other problems during storage, do not store the switch in locations subject to the following conditions.

1. High temperatures or humidity
2. Corrosive gases
3. Direct sunlight

Also, the switch is not waterproof or splash-resistant. Do not install or use the switch in locations that are subject to contact with water.

Do not subject the switch to freezing or condensation.

## ■ Cautions

Use the Toggle Switch within the rated voltage and current ranges, otherwise the Toggle Switch may have a shortened life expectancy, radiate heat, or burn out. This particularly applies to the instantaneous voltages and currents when switching.

### Handling

Do not apply excessive operating force to the Switch. Otherwise the Switch may be damaged or deformed, and the switch mechanism may malfunction as a result. Apply an operating force not exceeding 9.8 N (1,000 gf). Apply the operating load from the side of the striker in the direction of actuation travel. Do not apply a load from an angle or from above the striker. Doing so may deform the Switch contact.

## ■ RoHS Compliant

The "RoHS Compliant" designation indicates that the listed models do not contain the six hazardous substances covered by the RoHS Directive.

Reference: The following standards are used to determine compliance for the six substances.

Lead:	1,000 ppm max.
Mercury:	1,000 ppm max.
Cadmium:	100 ppm max.
Hexavalent chromium:	1,000 ppm max.
PBB:	1,000 ppm max.
PBDE:	1,000 ppm max.

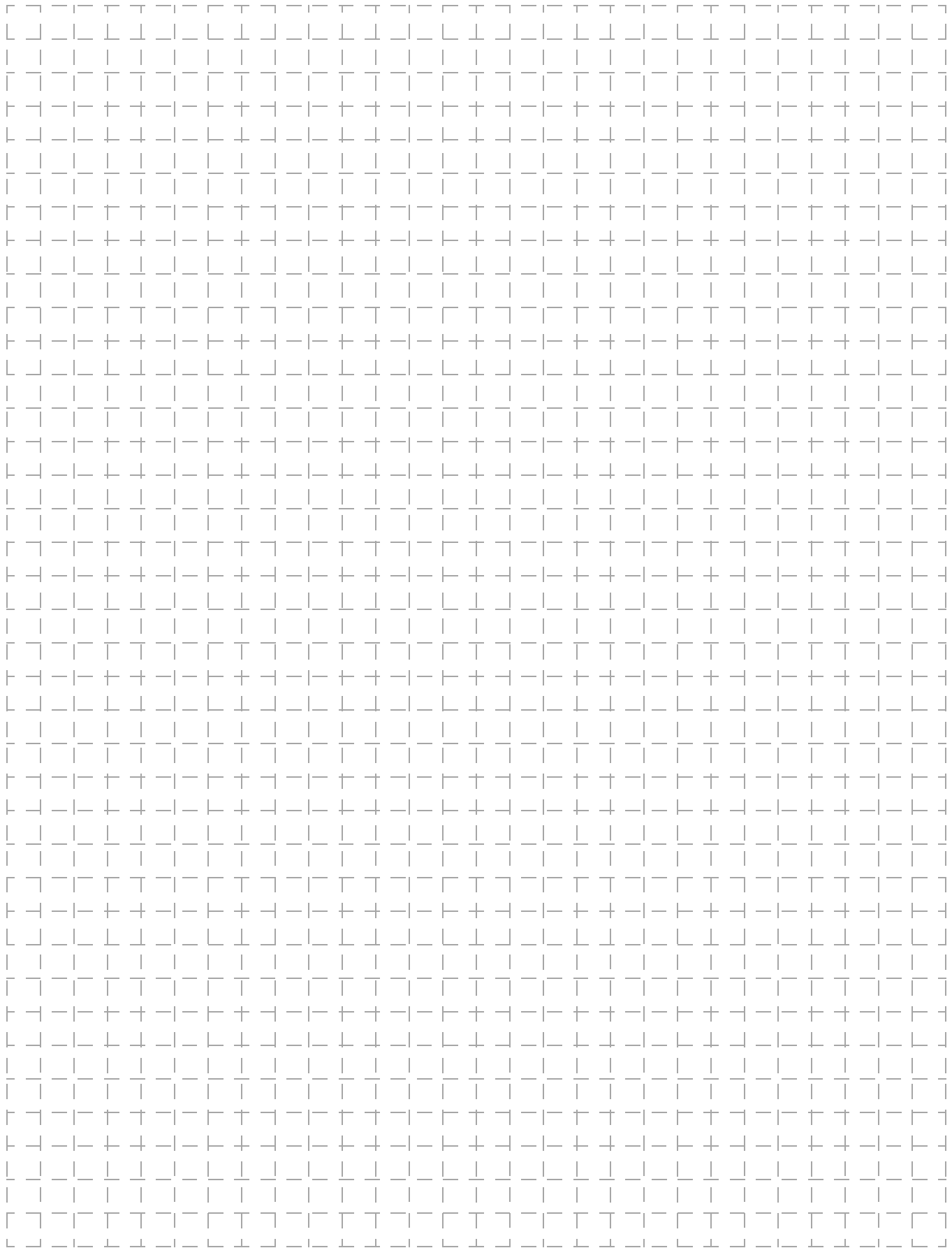

All sales are subject to Omron Electronic Components LLC standard terms and conditions of sale, which can be found at [http://www.components.omron.com/components/web/webfiles.nsf/sales\\_terms.html](http://www.components.omron.com/components/web/webfiles.nsf/sales_terms.html)

**ALL DIMENSIONS SHOWN ARE IN MILLIMETERS.**

To convert millimeters into inches, multiply by 0.03937. To convert grams into ounces, multiply by 0.03527.

---

**OMRON**<sup>®</sup>

**OMRON ELECTRONIC  
COMPONENTS LLC**

55 E. Commerce Drive, Suite B  
Schaumburg, IL 60173

**847-882-2288**

**OMRON ON-LINE**

Global - <http://www.omron.com>

USA - <http://www.components.omron.com>

Cat. No. A199-E-01

01/12

Specifications subject to change without notice

Printed in USA

## Данный компонент на территории Российской Федерации

### Вы можете приобрести в компании MosChip.

Для оперативного оформления запроса Вам необходимо перейти по данной ссылке:

<http://moschip.ru/get-element>

Вы можете разместить у нас заказ для любого Вашего проекта, будь то серийное производство или разработка единичного прибора.

В нашем ассортименте представлены ведущие мировые производители активных и пассивных электронных компонентов.

Нашей специализацией является поставка электронной компонентной базы двойного назначения, продукции таких производителей как XILINX, Intel (ex.ALTERA), Vicor, Microchip, Texas Instruments, Analog Devices, Mini-Circuits, Amphenol, Glenair.

Сотрудничество с глобальными дистрибьюторами электронных компонентов, предоставляет возможность заказывать и получать с международных складов практически любой перечень компонентов в оптимальные для Вас сроки.

На всех этапах разработки и производства наши партнеры могут получить квалифицированную поддержку опытных инженеров.

Система менеджмента качества компании отвечает требованиям в соответствии с ГОСТ Р ИСО 9001, ГОСТ РВ 0015-002 и ЭС РД 009

### Офис по работе с юридическими лицами:

105318, г.Москва, ул.Щербаковская д.3, офис 1107, 1118, ДЦ «Щербаковский»

Телефон: +7 495 668-12-70 (многоканальный)

Факс: +7 495 668-12-70 (доб.304)

E-mail: [info@moschip.ru](mailto:info@moschip.ru)

Skype отдела продаж:

moschip.ru

moschip.ru\_4

moschip.ru\_6

moschip.ru\_9