

NPN Silicon Darlington Transistors

- For general AF applications
- High collector current
- High current gain
- Complementary types: BCV28, BCV48 (PNP)
- Pb-free (RoHS compliant) package
- Qualified according AEC Q101

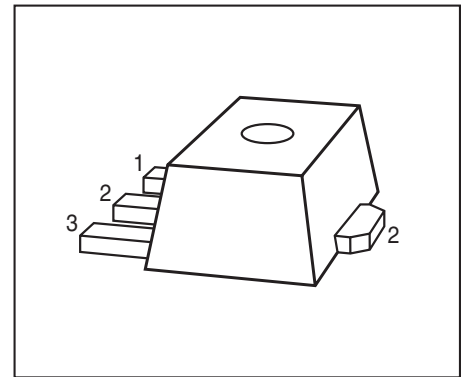

Type	Marking	Pin Configuration			Package
		1=B	2=C	3=E	
BCV29	EF	1=B	2=C	3=E	SOT89
BCV49	EG	1=B	2=C	3=E	SOT89

Maximum Ratings

Parameter	Symbol	Value	Unit
Collector-emitter voltage	V_{CEO}		V
BCV29		30	
BCV49		60	
Collector-base voltage	V_{CBO}		
BCV29		40	
BCV49		80	
Emitter-base voltage	V_{EBO}	10	
Collector current	I_C	500	mA
Peak collector current, $t_p \leq 10$ ms	I_{CM}	800	
Base current	I_B	100	
Peak base current	I_{BM}	200	
Total power dissipation- $T_S \leq 130$ °C	P_{tot}	1	W
Junction temperature	T_j	150	°C
Storage temperature	T_{stg}	-65 ... 150	

Thermal Resistance

Parameter	Symbol	Value	Unit
Junction - soldering point ¹⁾	R_{thJS}	≤ 20	K/W

¹⁾For calculation of R_{thJA} please refer to Application Note AN077 (Thermal Resistance Calculation)

Electrical Characteristics at $T_A = 25^\circ\text{C}$, unless otherwise specified

Parameter	Symbol	Values			Unit
		min.	typ.	max.	

DC Characteristics

Collector-emitter breakdown voltage $I_C = 10\text{ mA}$, $I_B = 0$, BCV29 $I_C = 10\text{ mA}$, $I_B = 0$, BCV49	$V_{(BR)CEO}$	30 60	- -	- -	V
Collector-base breakdown voltage $I_C = 100\text{ }\mu\text{A}$, $I_E = 0$, BCV29 $I_C = 100\text{ }\mu\text{A}$, $I_E = 0$, BCV49	$V_{(BR)CBO}$	40 80	- -	- -	
Emitter-base breakdown voltage $I_E = 10\text{ }\mu\text{A}$, $I_C = 0$	$V_{(BR)EBO}$	10	-	-	
Collector-base cutoff current $V_{CB} = 30\text{ V}$, $I_E = 0$, BCV29 $V_{CB} = 60\text{ V}$, $I_E = 0$, BCV49 $V_{CB} = 30\text{ V}$, $I_E = 0$, $T_A = 150^\circ\text{C}$, BCV29 $V_{CB} = 60\text{ V}$, $I_E = 0$, $T_A = 150^\circ\text{C}$, BCV49	I_{CBO}	- - - -	- - - -	0.1 0.1 10 10	μA
Emitter-base cutoff current $V_{EB} = 4\text{ V}$, $I_C = 0$	I_{EBO}	-	-	100	nA
DC current gain ¹⁾ $I_C = 100\text{ }\mu\text{A}$, $V_{CE} = 1\text{ V}$, BCV29 $I_C = 100\text{ }\mu\text{A}$, $V_{CE} = 1\text{ V}$, BCV49 $I_C = 10\text{ mA}$, $V_{CE} = 5\text{ V}$, BCV29 $I_C = 10\text{ mA}$, $V_{CE} = 5\text{ V}$, BCV49 $I_C = 100\text{ mA}$, $V_{CE} = 5\text{ V}$, BCV29 $I_C = 100\text{ mA}$, $V_{CE} = 5\text{ V}$, BCV49 $I_C = 0.5\text{ A}$, $V_{CE} = 5\text{ V}$, BCV29 $I_C = 0.5\text{ A}$, $V_{CE} = 5\text{ V}$, BCV49	h_{FE}	4000 2000 10000 4000 20000 10000 4000 2000	- - - - - - - -	- - - - - - - -	-
Collector-emitter saturation voltage ¹⁾ $I_C = 100\text{ mA}$, $I_B = 0.1\text{ mA}$	V_{CEsat}	-	-	1	V
Base emitter saturation voltage ¹⁾ $I_C = 100\text{ mA}$, $I_B = 0.1\text{ mA}$	V_{BEsat}	-	-	1.5	

¹Pulse test: $t < 300\mu\text{s}$; $D < 2\%$
Electrical Characteristics at $T_A = 25^\circ\text{C}$, unless otherwise specified

Parameter	Symbol	Values			Unit
		min.	typ.	max.	
AC Characteristics					
Transition frequency $I_C = 50\text{ mA}$, $V_{CE} = 5\text{ V}$, $f = 100\text{ MHz}$	f_T	-	150	-	MHz
Collector-base capacitance $V_{CB} = 10\text{ V}$, $f = 1\text{ MHz}$	C_{cb}	-	3	-	pF

DC current gain $h_{FE} = f(I_C)$

$V_{CE} = 5\text{ V}$

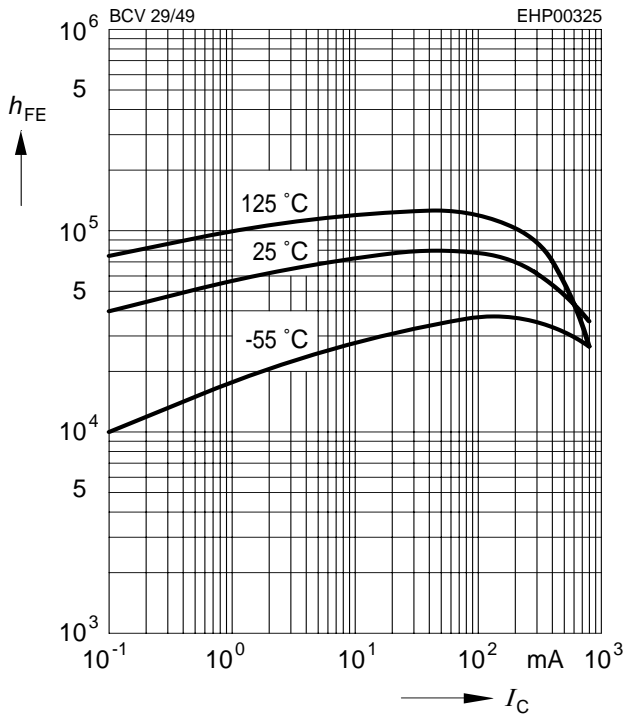

Collector-emitter saturation voltage

$I_C = f(V_{CEsat}), h_{FE} = 1000$

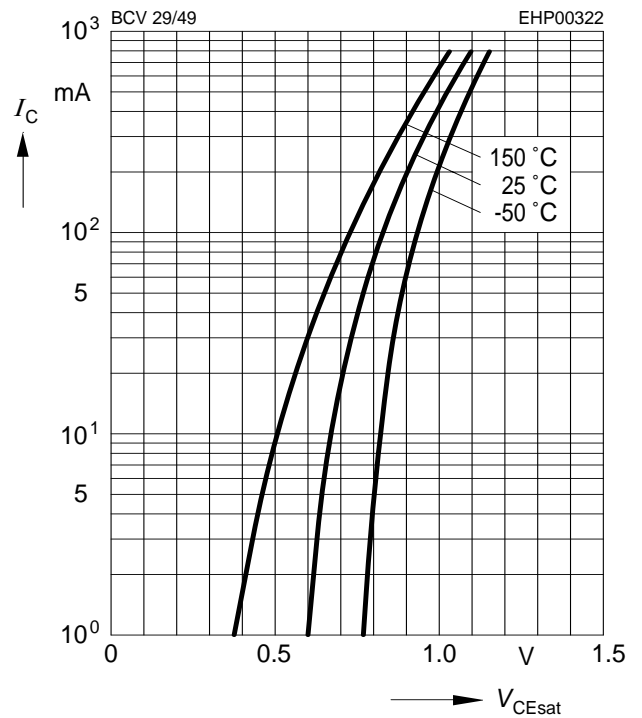

Base-emitter saturation voltage

$I_C = f(V_{BEsat}), h_{FE} = 1000$

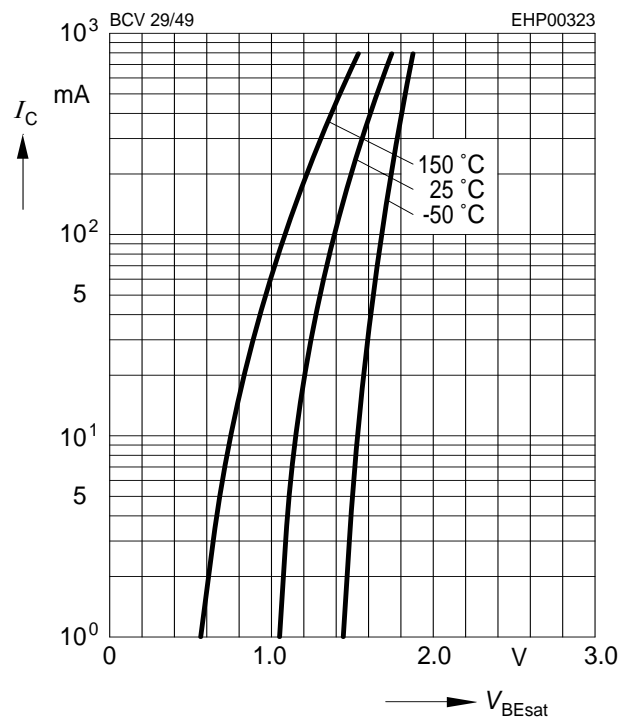

Collector cutoff current $I_{CBO} = f(T_A)$

$V_{CB} = V_{CEmax}$

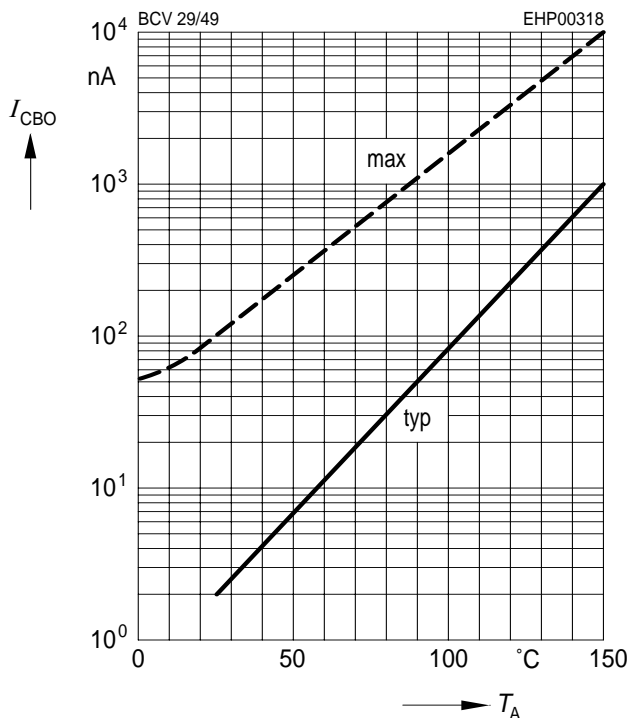

Transition frequency $f_T = f(I_C)$

$V_{CE} = 5\text{ V}$

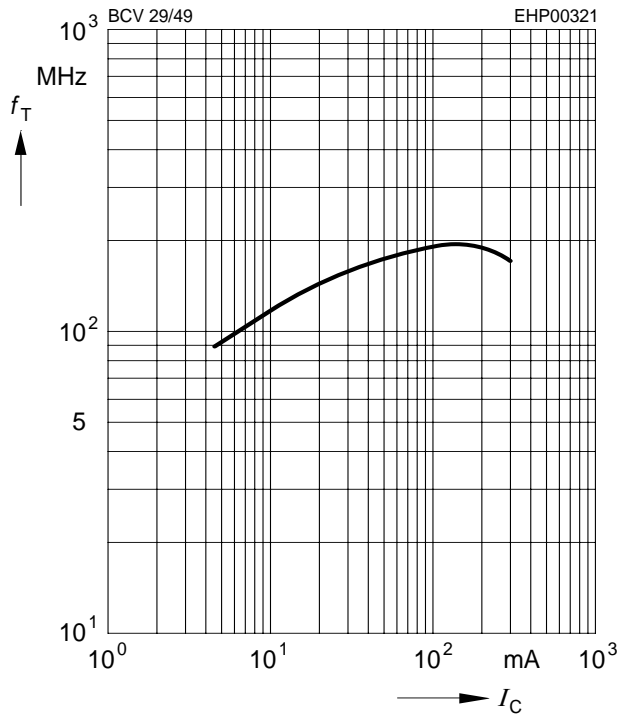

Collector-base capacitance $C_{cb} = f(V_{CB})$

Emitter-base capacitance $C_{eb} = f(V_{EB})$

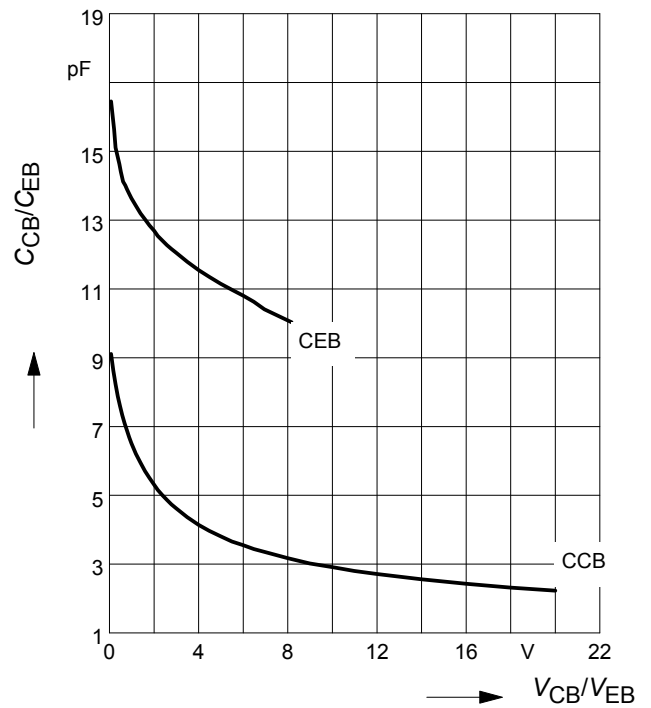

Total power dissipation $P_{tot} = f(T_S)$

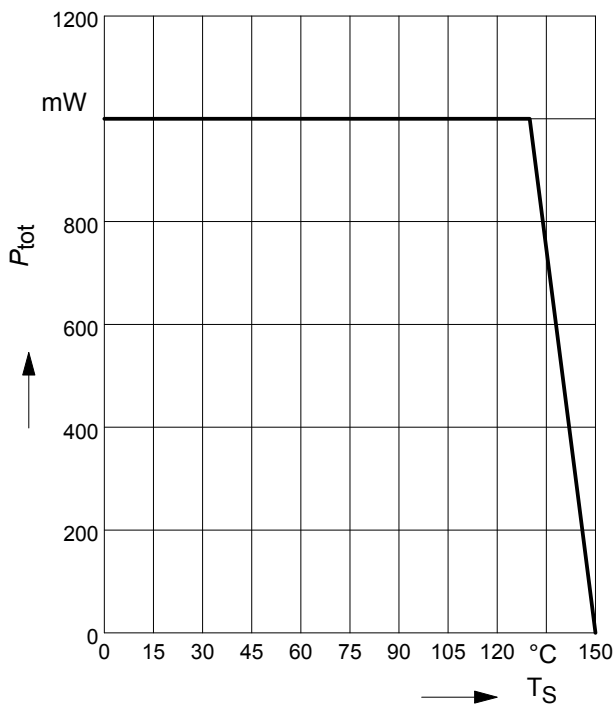

Permissible Pulse Load

$P_{totmax}/P_{totDC} = f(t_p)$

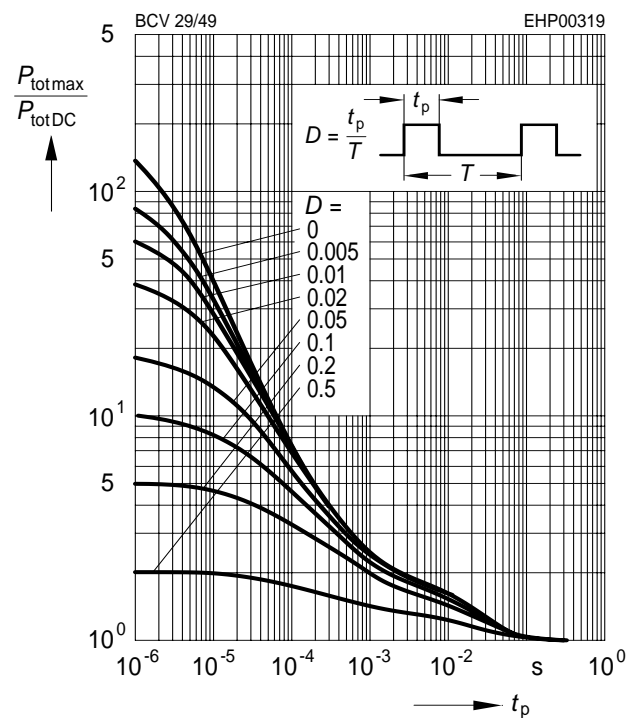

Package Outline

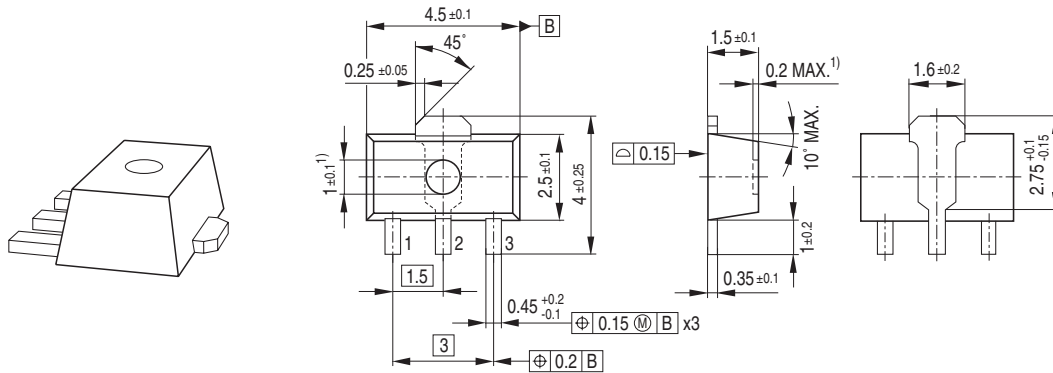

1) Ejector pin markings possible

Foot Print

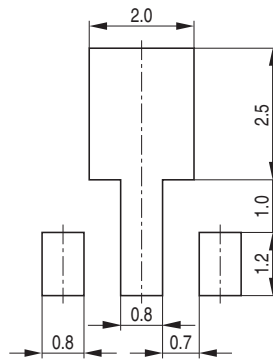

Marking Layout (Example)

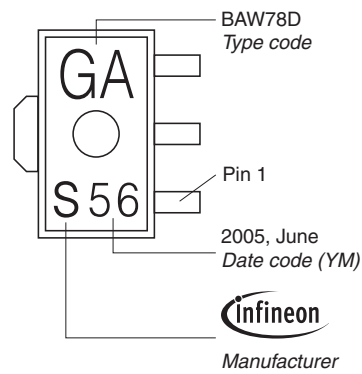

Standard Packing

Reel $\varnothing 180$ mm = 1.000 Pieces/Reel
 Reel $\varnothing 330$ mm = 4.000 Pieces/Reel

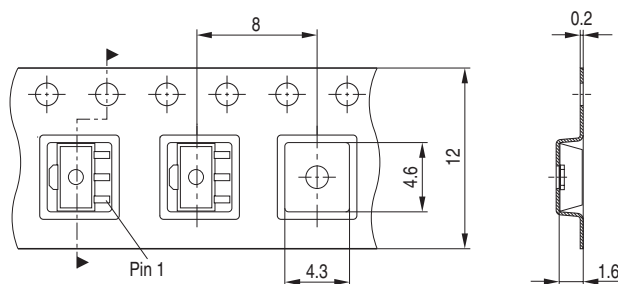

Edition 2009-11-16

**Published by
Infineon Technologies AG
81726 Munich, Germany**

**© 2009 Infineon Technologies AG
All Rights Reserved.**

Legal Disclaimer

The information given in this document shall in no event be regarded as a guarantee of conditions or characteristics. With respect to any examples or hints given herein, any typical values stated herein and/or any information regarding the application of the device, Infineon Technologies hereby disclaims any and all warranties and liabilities of any kind, including without limitation, warranties of non-infringement of intellectual property rights of any third party.

Information

For further information on technology, delivery terms and conditions and prices, please contact the nearest Infineon Technologies Office (www.infineon.com).

Warnings

Due to technical requirements, components may contain dangerous substances. For information on the types in question, please contact the nearest Infineon Technologies Office.

Infineon Technologies components may be used in life-support devices or systems only with the express written approval of Infineon Technologies, if a failure of such components can reasonably be expected to cause the failure of that life-support device or system or to affect the safety or effectiveness of that device or system. Life support devices or systems are intended to be implanted in the human body or to support and/or maintain and sustain and/or protect human life. If they fail, it is reasonable to assume that the health of the user or other persons may be endangered.

Данный компонент на территории Российской Федерации

Вы можете приобрести в компании MosChip.

Для оперативного оформления запроса Вам необходимо перейти по данной ссылке:

<http://moschip.ru/get-element>

Вы можете разместить у нас заказ для любого Вашего проекта, будь то серийное производство или разработка единичного прибора.

В нашем ассортименте представлены ведущие мировые производители активных и пассивных электронных компонентов.

Нашей специализацией является поставка электронной компонентной базы двойного назначения, продукции таких производителей как XILINX, Intel (ex.ALTERA), Vicor, Microchip, Texas Instruments, Analog Devices, Mini-Circuits, Amphenol, Glenair.

Сотрудничество с глобальными дистрибьюторами электронных компонентов, предоставляет возможность заказывать и получать с международных складов практически любой перечень компонентов в оптимальные для Вас сроки.

На всех этапах разработки и производства наши партнеры могут получить квалифицированную поддержку опытных инженеров.

Система менеджмента качества компании отвечает требованиям в соответствии с ГОСТ Р ИСО 9001, ГОСТ РВ 0015-002 и ЭС РД 009

Офис по работе с юридическими лицами:

105318, г.Москва, ул.Щербаковская д.3, офис 1107, 1118, ДЦ «Щербаковский»

Телефон: +7 495 668-12-70 (многоканальный)

Факс: +7 495 668-12-70 (доб.304)

E-mail: info@moschip.ru

Skype отдела продаж:

moschip.ru

moschip.ru_4

moschip.ru_6

moschip.ru_9