

## DESCRIPTION

The MP3307 is a non-synchronous WLED step-up driver with a 2.7V to 5.5V input range. It uses peak current mode to regulate the LED current sensed through an external low-side resistor.

The MP3307 features up to 2.2MHz of programmable switching frequency, making it easy to avoid noise interference, optimize efficiency, and reduce the output filter component size. To extend the dimming range, both analog and PWM dimming modes are supported with a separate input.

The MP3307 has LED open protection, output over-voltage protection, cycle-by-cycle current-limit protection, and thermal shutdown protection.

The MP3307 is available in a TSOT23-8 package, which is ideal for use in video displays.

## FEATURES

- 2.7V to 5.5V Input Voltage
- Analog Dimming with >20kHz Input Signal
- Direct PWM Dimming Mode with 100Hz to 2kHz Input Signal
- Up to 2.2MHz Programmable Switching Frequency
- Low 200mV Feedback Voltage with  $\pm 1\%$  Accuracy at Room Temperature
- 24V Open-Load Protection Threshold
- UVLO and Thermal Shutdown
- Cycle-by-Cycle Over-Current Protection
- Available in a TSOT23-8 Package

## APPLICATIONS

- Video Displays
- In-Car LCD Infotainment
- Tablets

All MPS parts are lead-free, halogen-free, and adhere to the RoHS directive. For MPS green status, please visit the MPS website under Quality Assurance. "MPS" and "The Future of Analog IC Technology" are registered trademarks of Monolithic Power Systems, Inc.

## TYPICAL APPLICATION

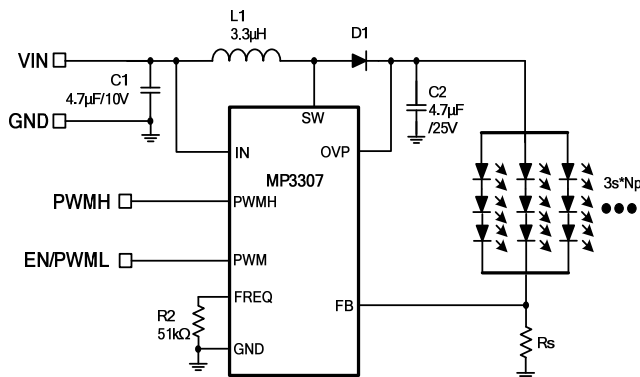

### Efficiency vs. $V_{IN}$

3S4P,  $F_{SW}=1.2\text{MHz}$ ,  
inductor: 3.3µH/65mΩ

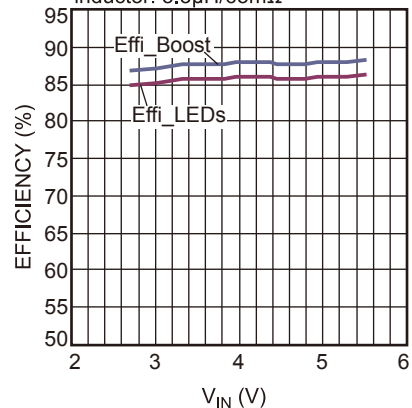

## ORDERING INFORMATION

Part Number*	Package	Top Marking
MP3307GJ	TSOT23-8	See Below

\* For Tape & Reel, add suffix –Z (e.g. MP3307GJ–Z)

## TOP MARKING

| ANFY

ANF: Product code of MP3307GJ  
Y: Year code

## PACKAGE REFERENCE

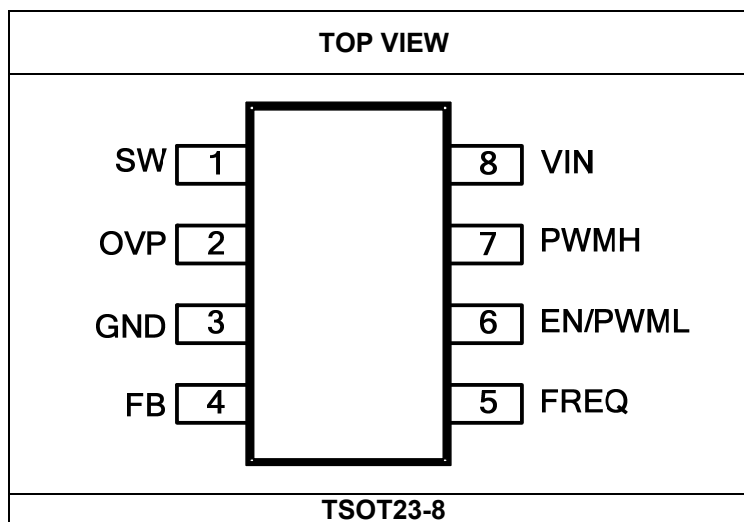

### ABSOLUTE MAXIMUM RATINGS <sup>(1)</sup>

$V_{IN}$ .....	-0.3V to +6V
$V_{SW}$ , $V_{OUT}$ .....	-1V to +40V
All other pins .....	-0.3V to +6V
Junction temperature .....	150°C
Lead temperature .....	260°C
Continuous power dissipation .....	( $T_A = 25^\circ\text{C}$ ) <sup>(2)</sup>
TSOT23-8 .....	1.25W

### Recommended Operating Conditions <sup>(3)</sup>

Supply voltage ( $V_{IN}$ ) .....	2.7V to 5.5V
Operating junction temp. ( $T_J$ )...	-40°C to +125°C

Thermal Resistance <sup>(4)</sup>	$\theta_{JA}$	$\theta_{JC}$
TSOT23-8 .....	100.....	55 °C/W

#### NOTES:

- Exceeding these ratings may damage the device.
- The maximum allowable power dissipation is a function of the maximum junction temperature  $T_J$  (MAX), the junction-to-ambient thermal resistance  $\theta_{JA}$ , and the ambient temperature  $T_A$ . The maximum allowable continuous power dissipation at any ambient temperature is calculated by  $P_D$  (MAX) =  $(T_J$  (MAX)- $T_A$ )/ $\theta_{JA}$ . Exceeding the maximum allowable power dissipation will cause an excessive die temperature, causing the regulator to go into thermal shutdown. Internal thermal shutdown circuitry protects the device from permanent damage.
- The device is not guaranteed to function outside of its operating conditions.
- Measured on JESD51-7, 4-layer PCB.

## ELECTRICAL CHARACTERISTICS

$V_{IN} = 3.6V$ ,  $V_{EN} = V_{IN}$ ,  $T_A = 25^{\circ}C$ , unless otherwise noted.

Parameters	Symbol	Condition	Min	Typ	Max	Units
<b>Step-Up Converter</b>						
Operating input voltage	$V_{IN}$		2.7		5.5	V
Supply current (quiescent)	$I_Q$	No load with switching		440		$\mu A$
Supply current (shutdown)	$I_{ST}$	$V_{EN} = 0V$ , $V_{IN} = 3.6V$			1	$\mu A$
Input UVLO threshold	$V_{IN\_UVLO}$	Rising edge		2.5		V
Input UVLO hysteresis				200		mV
EN high voltage	$V_{EN\_HIGH}$	$V_{EN}$ rising	1.2			V
EN low voltage	$V_{EN\_LOW}$	$V_{EN}$ falling			0.4	V
Switching frequency	$f_{SW}$	$R_{OSC} = 51k\Omega$		2.22		MHz
Maximum duty cycle	$D_{MAX}$		90	93		%
Feedback regulation voltage	$V_{REF}$		198	200	202	mV
$V_{REF}$ ramp-up time per step	$t_{STEP}$			320		$\mu s$
<b>Power Switch</b>						
Main switch on resistance	$R_{DSON\_M}$	$V_{IN} = 3.6V$		0.3	0.5	$\Omega$
<b>Current Dimming</b>						
PWMH input low threshold	$V_{PWM\_LO}$	$V_{PWM}$ falling			0.4	V
PWMH input high threshold	$V_{PWM\_HI}$	$V_{PWM}$ rising	1.2			V
PWML shutdown time	$t_{SD}$	EN/PWML high to low		20		ms
<b>Protection</b>						
OVP voltage	$V_{OVP}$	OVP	22.5	24	25.5	V
		Hysteresis		2		V
Cycle-by-cycle current limit	$I_{LIM}$		1.6			A
OVP UVLO threshold	$V_{OVP\_UV}$			1.25		V
Thermal shutdown threshold	$t_{ST}$			150		$^{\circ}C$
Thermal shutdown hysteresis				25		$^{\circ}C$

## TYPICAL PERFORMANCE CHARACTERISTICS

$V_{IN} = 3.6V$ , 3s\*4p LEDs,  $L = 3.3\mu H$ ,  $f_s = 2.2MHz$ ,  $T_A = 25^\circ C$ , unless otherwise noted.

**PWM Dimming Curve**

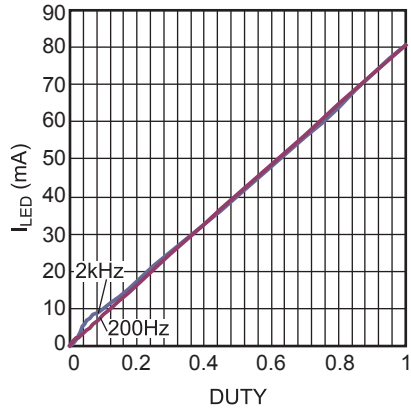

**Analog Dimming Curve**

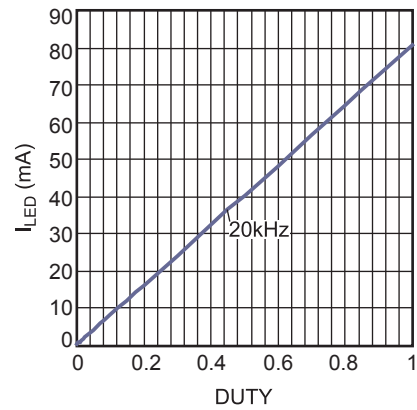

**TYPICAL PERFORMANCE CHARACTERISTICS (continued)**
 $V_{IN} = 3.6V$ , 3s\*4p LEDs,  $L = 3.3\mu H$ ,  $f_s = 2.2MHz$ ,  $T_A = 25^\circ C$ , unless otherwise noted.

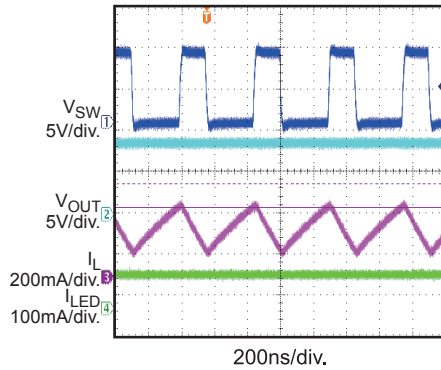
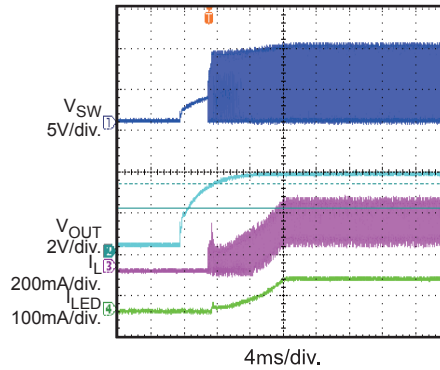
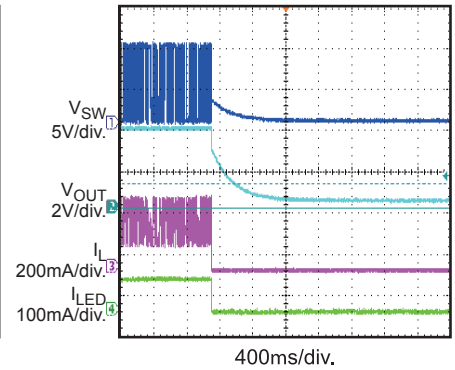
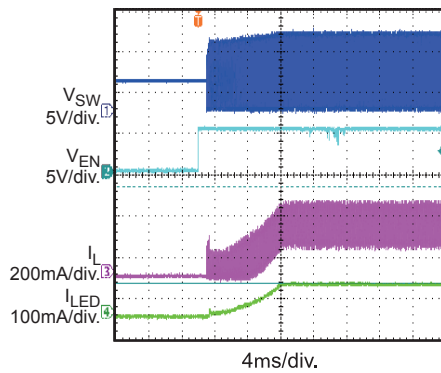
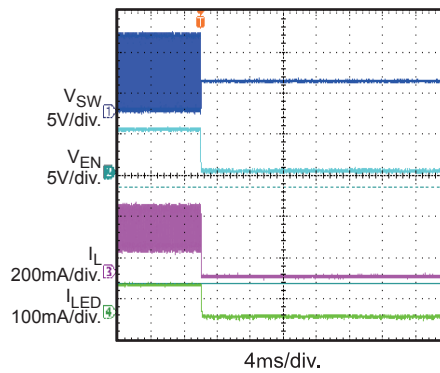
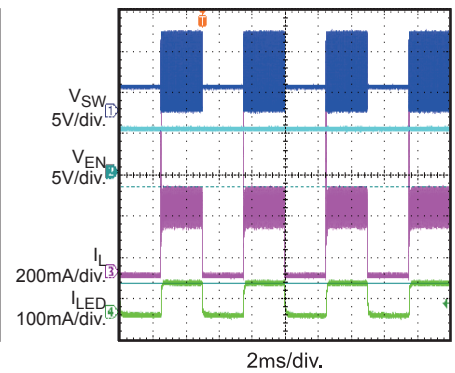
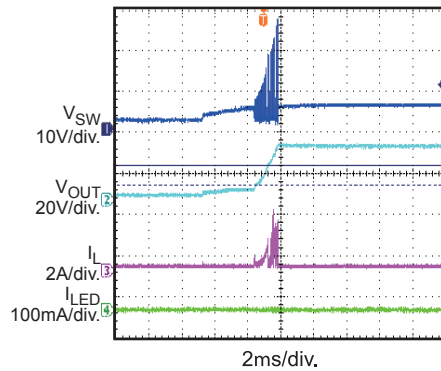
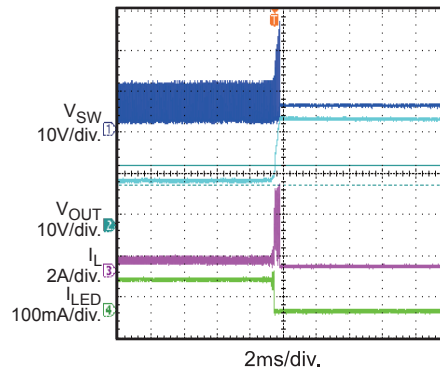
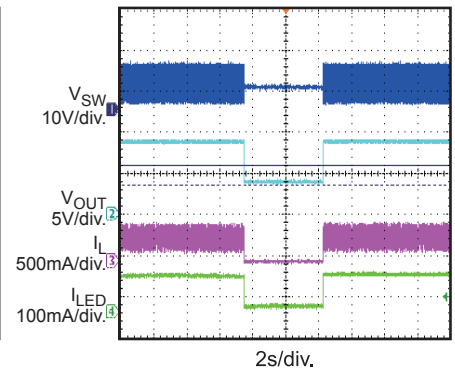
**Steady State**

 **$V_{IN}$  Power On**

 **$V_{IN}$  Power Off**

**EN Power On**

**EN Power Off**

**PWM Dimming**
 $F_{PWM} = 200Hz$ ,  $D = 50\%$ 

**Start-Up in Open Load**

**Open Load in Normal Operation**

**Thermal Shutdown then Recover**

## PIN FUNCTIONS

Pin #	Name	Description
1	SW	<b>Power switch node.</b> SW is the drain of the internal low-side MOSFET. Connect the power inductor between SW and $V_{IN}$ .
2	OVP	<b>Over-voltage sensing.</b>
3	GND	<b>Ground.</b>
4	FB	<b>LED current feedback.</b> FB regulates the voltage across the current-sense resistor between FB and GND to 200mV.
5	FREQ	<b>Switching frequency set.</b> Connect a resistor between FREQ and GND to program the converter switching frequency. Do NOT leave FREQ floating.
6	EN/PWML	<b>PWM brightness control/enable.</b> Apply a PWM signal for PWM dimming. The PWM frequency is proportional to the LED current dimming ratio—a lower dimming frequency results in a smaller dimming current. For most applications, use a frequency range of 200Hz to 2kHz. A low-level signal longer than 20ms will shut down the IC.
7	PWMH	<b>Analog dimming input.</b> A >20kHz PWM signal is recommended if a PWM signal input is being used for analog dimming.
8	VIN	<b>Input supply.</b> VIN provides power for internal power and the logic circuits. VIN must be bypassed locally.

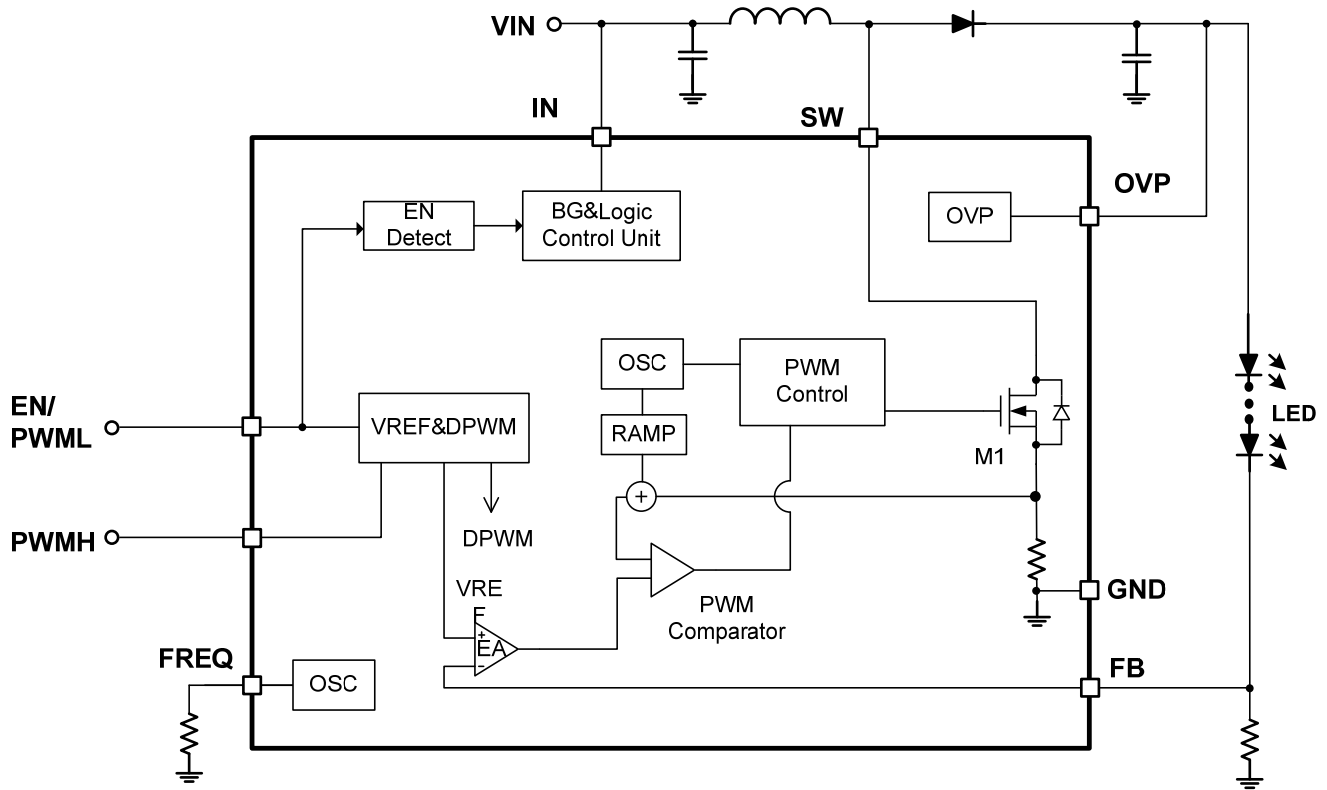

Figure 1: Functional Block Diagram

## OPERATION

The MP3307 uses peak-current-mode control to regulate the current through the WLED string. At the start of each oscillator cycle, the control circuit turns on the low-side MOSFET (LS-FET, M1). A stabilizing ramp is added to the output of the current sense amplifier, which feeds into the positive input of the PWM comparator and prevents sub-harmonic oscillations at duty cycles greater than 50%. When the input of the PWM comparator equals the output voltage of the error amplifier, M1 turns off. The inductor current then flows through the external Schottky diode, which forces the inductor current to decrease.

The voltage at the output of the error amplifier is the amplified difference between the 200mV reference voltage and the feedback voltage. If the feedback voltage starts to drop, the output of the error amplifier increases. This also increases the current flowing through M1, the power to the inductor, and the output power. This method regulates the LED current accurately.

### System Start-Up

When enabled, the MP3307 checks safety limits, including UVLO, over-temperature protection (OTP), and over-current protection (OCP). If all of the protection tests pass, the chip then boosts the step-up converter with an internal soft start. During the soft start, the current reference increases from 0 to 200mV in 32 steps (320μs per step) to prevent a large inrush current.

### Dimming Control

The MP3307 provides two dimming methods: PWM dimming and analog dimming mode.

For PWM dimming, apply a PWM signal to EN/PWML. The LED current is then segmented according to the PWM signal and the average LED current. See Equation (1):

$$I_{\text{set}} \times D_{\text{dim}} \quad (1)$$

Where  $D_{\text{dim}}$  is the PWM duty cycle, and  $I_{\text{set}}$  is the LED current amplitude.

When the PWM signal is high, the converter operates in normal mode. Conversely, when the PWM amplitude is low, the converter stops switching. If the PWM signal low-level time is more than 20ms, the IC shuts down. Use a 100Hz to 2kHz PWM dimming frequency for most dimming ratio requests.

For analog dimming, connect the PWM dimming signal to PWMH. An internal RC filter filters the PWM signal. The LED current amplitude equals  $I_{\text{set}} \times D_{\text{dim}}$ , where  $D_{\text{dim}}$  is the PWM duty cycle, and  $I_{\text{set}}$  is the LED current amplitude. Use a >20kHz PWM signal to improve filtering performance.

### Open-String Protection

The MP3307 monitors  $V_{\text{OUT}}$  for open-string protection. If the LED string is open, the feedback voltage is lower than the reference voltage. The COMP then rises and charges the output capacitor until the  $V_{\text{OUT}}$  reaches the protection point ( $V_{\text{OVP}}$ ).

The IC stops switching when  $V_{\text{OUT}}$  reaches the OVP threshold; it resumes operation when  $V_{\text{OUT}}$  drops below the threshold.

### Input Under-Voltage Protection

When  $V_{\text{IN}}$  exceeds 2.5V, the converter starts to charge the internal reference and provides power to the internal control circuitry. There is an UVLO hysteresis (approximately 200mV) as  $V_{\text{IN}}$  falls. The IC shuts down when the input voltage drops below 2.3V.

### Thermal Shutdown Protection

Thermal shutdown prevents the IC from operating at exceedingly high temperatures. When the die temperature exceeds the upper threshold ( $T_{\text{ST}}$ ), the IC shuts down; it resumes normal operation when the die temperature drops below the lower threshold. Typically, the hysteresis is 25°C.



## APPLICATION INFORMATION

### Selecting the Switching Frequency

The switching frequency of the step-up converter can be programmed from 300kHz to 1.2MHz. A resistor on OSC sets the internal oscillator frequency for the step-up converter with Equation (2):

$$f_{\text{sw}}(\text{kHz}) = \frac{120000}{R_{\text{OSC}}(\text{k}\Omega)} \quad (2)$$

For instance, if  $R_{\text{OSC}}=51\text{k}\Omega$ , then the switching frequency is 2.35MHz.

### Setting the LED Current

Set the LED current through the current-setting resistor on FB using Equation (3):

$$I_{\text{LED}}(\text{mA}) = \frac{V_{\text{REF}}(\text{V})}{R_{\text{FB}}(\Omega)} \times 1000 \quad (3)$$

For instance, if  $V_{\text{REF}}=200\text{mV}$ , and  $R_{\text{FB}}=10\Omega$ , then the LED current is 20mA. Do NOT leave FB floating.

### Selecting the Input Capacitor

The input capacitor reduces the surge current drawn from the input supply and the switching noise from the device. The input capacitor impedance at the switching frequency should be less than the input source impedance to prevent the high-frequency switching current from passing through to the input. Use ceramic capacitors with X5R or X7R dielectrics for their low ESR and small temperature coefficients. For most applications, use a 2.2 $\mu\text{F}$  to 10 $\mu\text{F}$  ceramic capacitor.

### Selecting the Inductor

The MP3307 requires an inductor to boost its output voltage. An inductor with a larger value results in less ripple current; it also lowers both the peak inductor current and stress on the internal N-channel MOSFET. However, the larger inductor is physically larger and has both a higher series resistance and a lower saturation current.

Choose an inductor that does not saturate under the worst-case load conditions. Select a minimum inductor value to ensure that the boost converter works in continuous conduction

mode with high efficiency and good EMI performance.

Calculate the required inductance value using Equation (4) and Equation (5):

$$L \geq \frac{\eta \times V_{\text{OUT}} \times D \times (1-D)^2}{2 \times f_{\text{sw}} \times I_{\text{LOAD}}} \quad (4)$$

$$D = 1 - \frac{V_{\text{IN}}}{V_{\text{OUT}}} \quad (5)$$

Where  $V_{\text{IN}}$  and  $V_{\text{OUT}}$  are the input and output voltages,  $f_{\text{sw}}$  is the switching frequency,  $I_{\text{LOAD}}$  is the LED load current, and  $\eta$  is the efficiency.

To avoid hitting the switching current limit for peak current mode, the worst-case inductor peak current should be less than 80% of the current limit ( $I_{\text{LIM}}$ ).

### Selecting the Output Capacitor

The output capacitor keeps the output voltage ripple small and ensures feedback loop stability. The output capacitor impedance must be low at the switching frequency. Ceramic capacitors with X7R dielectrics are recommended for their low ESR characteristics. Selection must also account for the capacitance's dependence on the voltage rating. With DC bias voltage, the capacitor can lose as much as 50% of its capacitance at its rated voltage rating. Leave a sufficient voltage rating margin when selecting the component.

A capacitance that is too low or too high causes loop instability. For most applications, select a capacitor in the range of 2.2 $\mu\text{F}$  to 10 $\mu\text{F}$ .

### PCB Layout Guidelines

Efficient PCB layout is critical for preventing noise, limiting electromagnetic interference, and achieving stable operation. For best results, refer to Figure 2 and follow the guidelines below:

1. Minimize the loop consisting of the MP3307's internal low-side MOSFET, external Schottky diode, and output capacitor, as it contains a high-frequency ripple current.
2. Place the input and output capacitors as close to the IC as possible.

### TYPICAL APPLICATION CIRCUITS

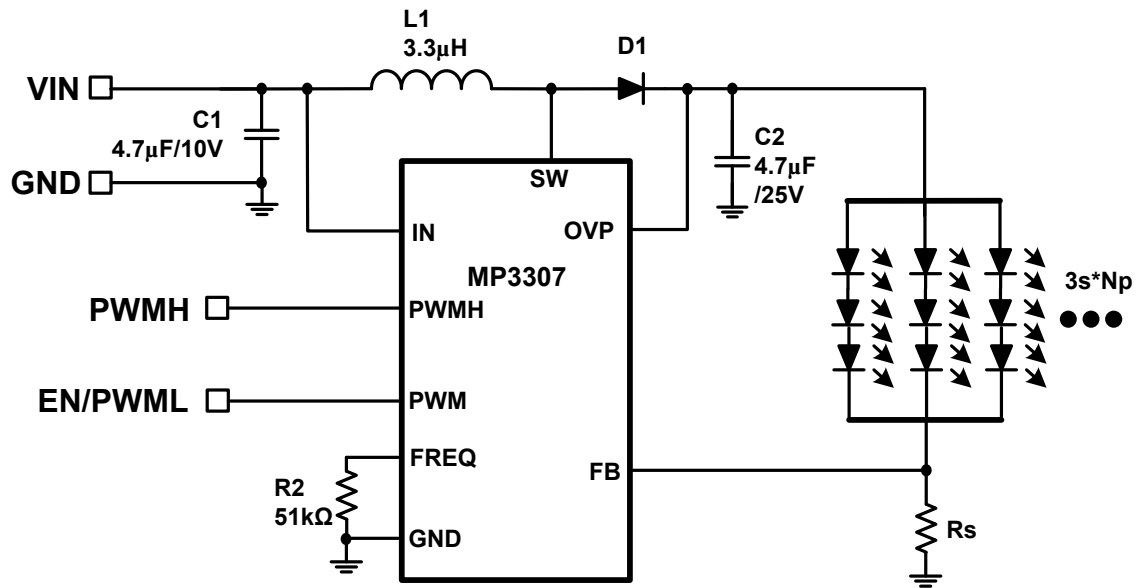
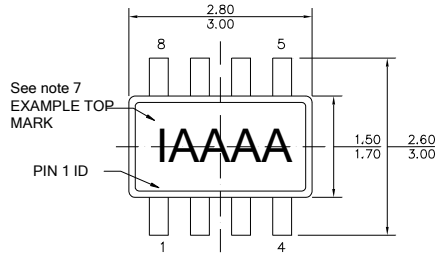

Figure 2: Typical Application for 3s\*Np LEDs

## PACKAGE INFORMATION

### TSOT23-8



TOP VIEW

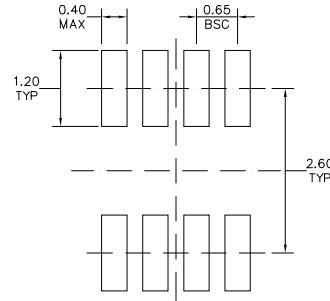

RECOMMENDED LAND PATTERN

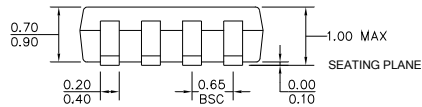

FRONT VIEW

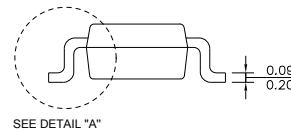

SIDE VIEW

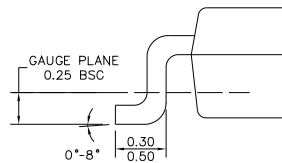

DETAIL "A"

#### NOTE:

- 1) ALL DIMENSIONS ARE IN MILLIMETERS.
- 2) PACKAGE LENGTH DOES NOT INCLUDE MOLD FLASH, PROTRUSION OR GATE BURR.
- 3) PACKAGE WIDTH DOES NOT INCLUDE INTERLEAD FLASH OR PROTRUSION.
- 4) LEAD COPLANARITY (BOTTOM OF LEADS AFTER FORMING) SHALL BE 0.10 MILLIMETERS MAX.
- 5) JEDEC REFERENCE IS MO-193, VARIATION BA.
- 6) DRAWING IS NOT TO SCALE.
- 7) PIN 1 IS LOWER LEFT PIN WHEN READING TOP MARK FROM LEFT TO RIGHT, (SEE EXAMPLE TOP MARK)

**NOTICE:** The information in this document is subject to change without notice. Please contact MPS for current specifications. Users should warrant and guarantee that third party Intellectual Property rights are not infringed upon when integrating MPS products into any application. MPS will not assume any legal responsibility for any said applications.

## Данный компонент на территории Российской Федерации

### Вы можете приобрести в компании MosChip.

Для оперативного оформления запроса Вам необходимо перейти по данной ссылке:

<http://moschip.ru/get-element>

Вы можете разместить у нас заказ для любого Вашего проекта, будь то серийное производство или разработка единичного прибора.

В нашем ассортименте представлены ведущие мировые производители активных и пассивных электронных компонентов.

Нашей специализацией является поставка электронной компонентной базы двойного назначения, продукции таких производителей как XILINX, Intel (ex.ALTERA), Vicor, Microchip, Texas Instruments, Analog Devices, Mini-Circuits, Amphenol, Glenair.

Сотрудничество с глобальными дистрибьюторами электронных компонентов, предоставляет возможность заказывать и получать с международных складов практически любой перечень компонентов в оптимальные для Вас сроки.

На всех этапах разработки и производства наши партнеры могут получить квалифицированную поддержку опытных инженеров.

Система менеджмента качества компании отвечает требованиям в соответствии с ГОСТ Р ИСО 9001, ГОСТ РВ 0015-002 и ЭС РД 009

### Офис по работе с юридическими лицами:

105318, г.Москва, ул.Щербаковская д.3, офис 1107, 1118, ДЦ «Щербаковский»

Телефон: +7 495 668-12-70 (многоканальный)

Факс: +7 495 668-12-70 (доб.304)

E-mail: [info@moschip.ru](mailto:info@moschip.ru)

Skype отдела продаж:

moschip.ru

moschip.ru\_4

moschip.ru\_6

moschip.ru\_9