

NPN SILICON PLANAR MEDIUM POWER TRANSISTORS IN SOT89
Features

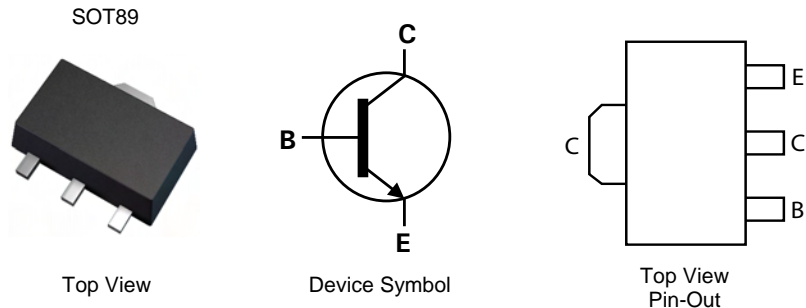
- $I_C = 1A$ Continuous Collector Current
- Low Saturation Voltage $V_{CE(sat)} < 500mV @ 0.5A$
- Gain Groups 10 and 16
- Epitaxial Planar Die Construction
- Complementary PNP types: BCX51, 52, and 53
- **Totally Lead-Free & Fully RoHS compliant (Notes 1 & 2)**
- **Halogen and Antimony Free. "Green" Device (Note 3)**
- **Qualified to AEC-Q101 Standards for High Reliability**
- **PPAP capable (Note 4)**

Mechanical Data

- Case: SOT89
- Case Material: Molded Plastic, "Green" Molding Compound
- UL Flammability Rating 94V-0
- Moisture Sensitivity: Level 1 per J-STD-020
- Terminals: Matte Tin Finish Leads, Solderable per MIL-STD-202 Method 208 (E3)
- Weight: 0.072 grams (Approximate)

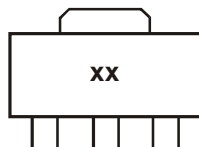
Applications

- Medium Power Switching or Amplification Applications
- AF driver and output stages


Ordering Information (Notes 4 & 5)

Product	Compliance	Marking	Reel size (inches)	Tape width (mm)	Quantity per reel
BCX54TA	AEC-Q101	BA	7	12	1,000
BCX5410TA	AEC-Q101	BC	7	12	1,000
BCX5416TA	AEC-Q101	BD	7	12	1,000
BCX5416-13R	AEC-Q101	BD	13	12	4,000
BCX55TA	AEC-Q101	BE	7	12	1,000
BCX5510TA	AEC-Q101	BG	7	12	1,000
BCX5516TA	AEC-Q101	BM	7	12	1,000
BCX56TA	AEC-Q101	BH	7	12	1,000
BCX5610TA	AEC-Q101	BK	7	12	1,000
BCX5616TA	AEC-Q101	BL	7	12	1,000
BCX5616QTA	Automotive	BL	7	12	1,000
BCX5616TC	AEC-Q101	BL	13	12	4,000

- Notes:
1. No purposely added lead. Fully EU Directive 2002/95/EC (RoHS) & 2011/65/EU (RoHS 2) compliant.
 2. See <http://www.diodes.com> for more information about Diodes Incorporated's definitions of Halogen and Antimony free, "Green" and Lead-Free.
 3. Halogen and Antimony free "Green" products are defined as those which contain <900ppm bromine, <900ppm chlorine (<1500ppm total Br + Cl) and <1000ppm antimony compounds.
 4. Automotive products are AEC-Q101 qualified and are PPAP capable. Automotive, AEC-Q101 and standard products are electrically and thermally the same, except where specified.
 5. For packaging details, go to our website at <http://www.diodes.com>

Marking Information


xx = Product Type Marking Code, as follows:

BCX54 = BA	BCX55 = BE	BCX56 = BH
BCX5410 = BC	BCX5510 = BG	BCX5610 = BK
BCX5416 = BD	BCX5516 = BM	BCX5616 = BL

Maximum Ratings (@ $T_A = +25^\circ\text{C}$, unless otherwise specified.)

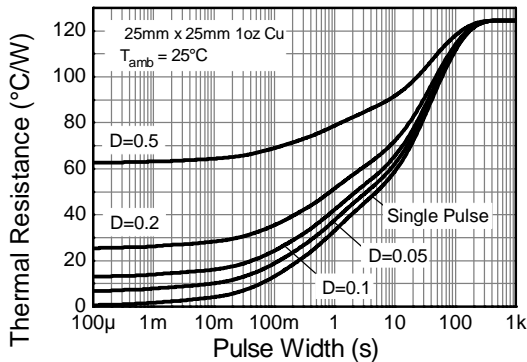
Characteristic	Symbol	BCX54	BCX55	BCX56	Unit
Collector-Base Voltage	V_{CBO}	45	60	100	V
Collector-Emitter Voltage	V_{CEO}	45	60	80	V
Emitter-Base Voltage	V_{EBO}	6			V
Continuous Collector Current	I_C	1			A
Peak Pulse Collector Current	I_{CM}	1.5			
Continuous Base Current	I_B	100			mA
Peak Pulse Base Current	I_{BM}	200			

Thermal Characteristics

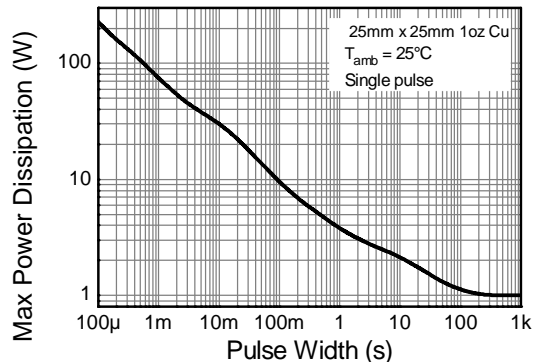
Characteristic	Symbol	Value	Unit
Power Dissipation (Note 6)	P_D	1	W
Thermal Resistance, Junction to Ambient (Note 6)	$R_{\theta JA}$	124	$^\circ\text{C/W}$
Thermal Resistance, Junction to Leads (Note 7)	$R_{\theta JL}$	10.0	$^\circ\text{C/W}$
Operating and Storage Temperature Range	T_J, T_{STG}	-65 to +150	$^\circ\text{C}$

Notes: 6. For a device surface mounted on 25mm X 25mm FR4 PCB with high coverage of single sided 1 oz copper, in still air conditions; the device is measured when operating in a steady-state condition.
 7. Thermal resistance from junction to solder-point (on the exposed collector pad).

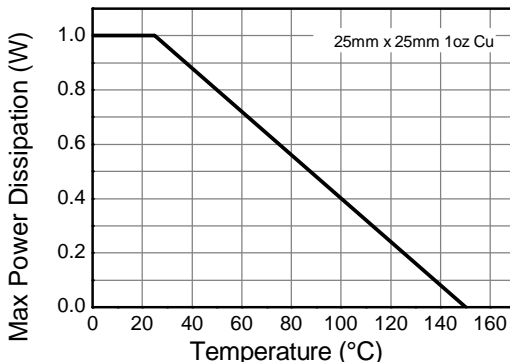
Thermal Characteristics



Transient Thermal Impedance



Pulse Power Dissipation



Derating Curve

Electrical Characteristics (@ $T_A = +25^\circ\text{C}$, unless otherwise specified.)

Characteristic	Symbol	Min	Typ	Max	Unit	Test Condition	
Collector-Base Breakdown Voltage	BV_{CBO}	45	—	—	V	$I_C = 100\mu\text{A}$	
		60					
		100					
Collector-Emitter Breakdown Voltage (Note 8)	BV_{CEO}	45	—	—	V	$I_C = 10\text{mA}$	
		60					
		80					
Emitter-Base Breakdown Voltage	BV_{EBO}	6	—	—	V	$I_E = 100\mu\text{A}$	
Collector Cut-off Current	I_{CBO}	-	—	0.1 20	μA	$V_{CB} = 30\text{V}$ $V_{CB} = 30\text{V}, T_A = +150^\circ\text{C}$	
Emitter Cut-off Current	I_{EBO}	-	—	20	nA	$V_{EB} = 5\text{V}$	
Static Forward Current Transfer Ratio (Note 6)	All versions	h_{FE}	25	—	-	—	$I_C = 5\text{mA}, V_{CE} = 2\text{V}$ $I_C = 150\text{mA}, V_{CE} = 2\text{V}$ $I_C = 500\text{mA}, V_{CE} = 2\text{V}$ $I_C = 150\text{mA}, V_{CE} = 2\text{V}$ $I_C = 150\text{mA}, V_{CE} = 2\text{V}$
			40				
			25				
			63				
Collector-Emitter Saturation Voltage (Note 8)	$V_{CE(sat)}$	—	—	0.5	V	$I_C = 500\text{mA}, I_B = 50\text{mA}$	
Base-Emitter Turn-On Voltage (Note 8)	$V_{BE(on)}$	—	—	1.0	V	$I_C = 500\text{mA}, V_{CE} = 2\text{V}$	
Transition Frequency	f_T	150	—	-	MHz	$I_C = 50\text{mA}, V_{CE} = 10\text{V}$ $f = 100\text{MHz}$	
Output Capacitance	C_{obo}	—	—	25	pF	$V_{CB} = 10\text{V}, f = 1\text{MHz}$	

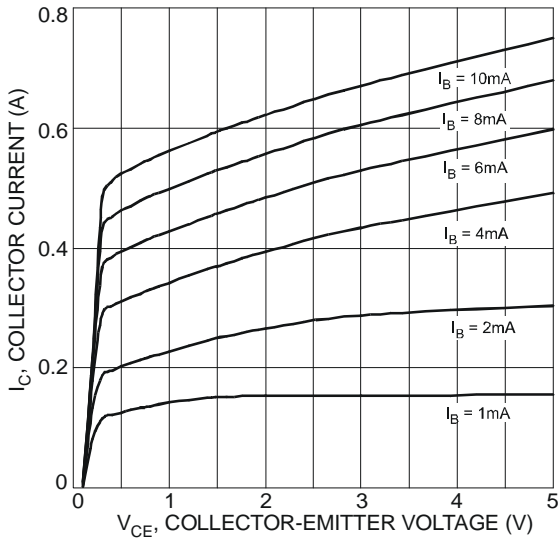
 Notes: 8. Measured under pulsed conditions. Pulse width $\leq 300\mu\text{s}$. Duty cycle $\leq 2\%$.


Fig. 1 Typical Collector Current vs. Collector-Emitter Voltage

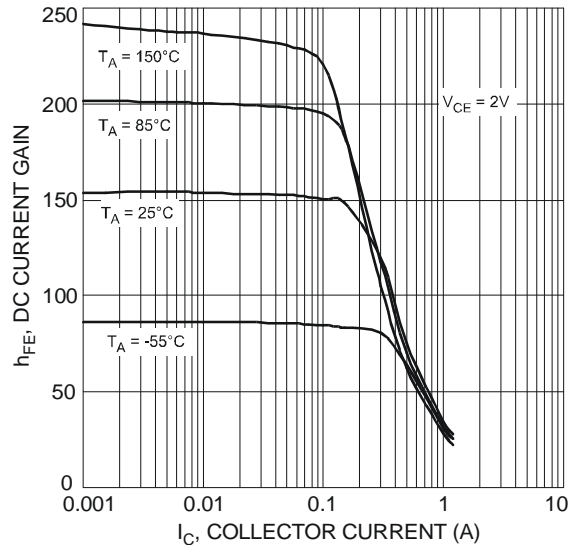


Fig. 2 Typical DC Current Gain vs. Collector Current

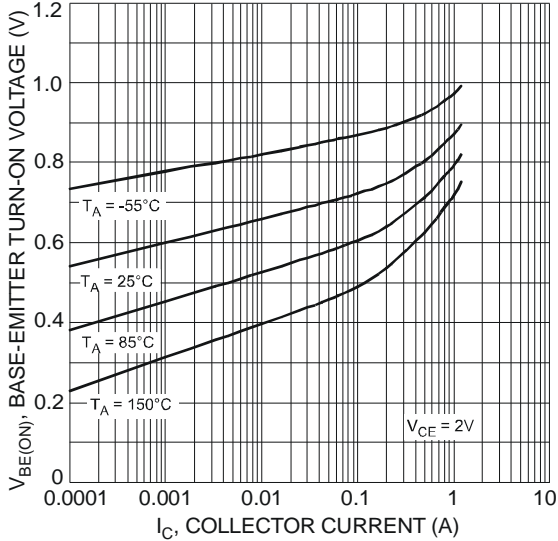


Fig. 3 Typical Base-Emitter Turn-On Voltage vs. Collector Current

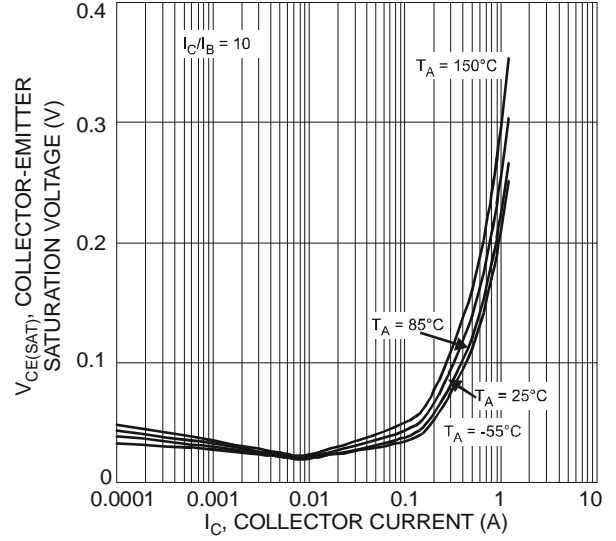


Fig. 4 Typical Collector-Emitter Saturation Voltage vs. Collector Current

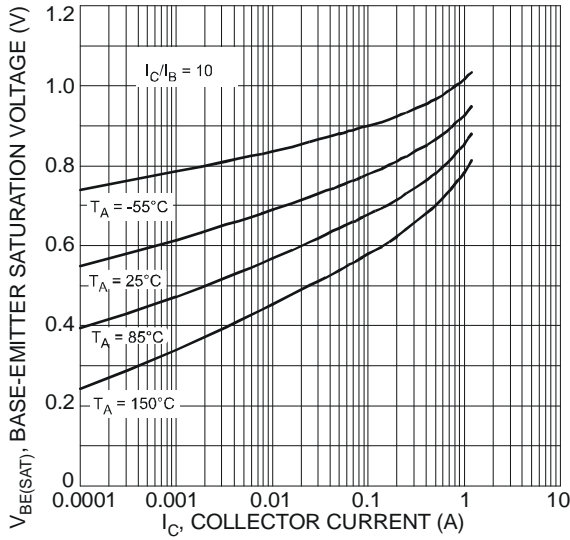


Fig. 5 Typical Base-Emitter Saturation Voltage vs. Collector Current

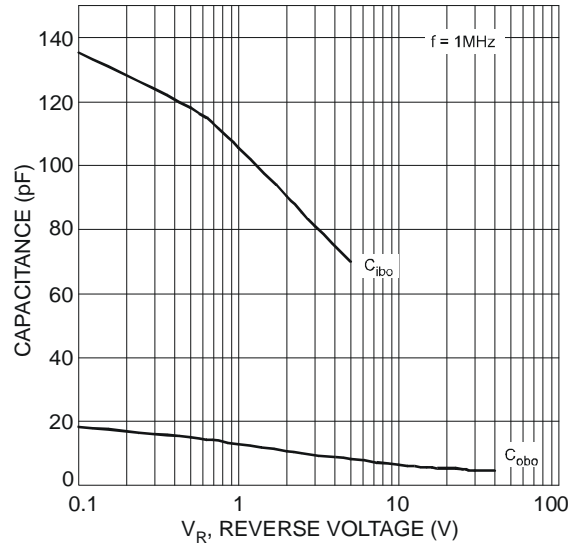


Fig. 6 Typical Capacitance Characteristics

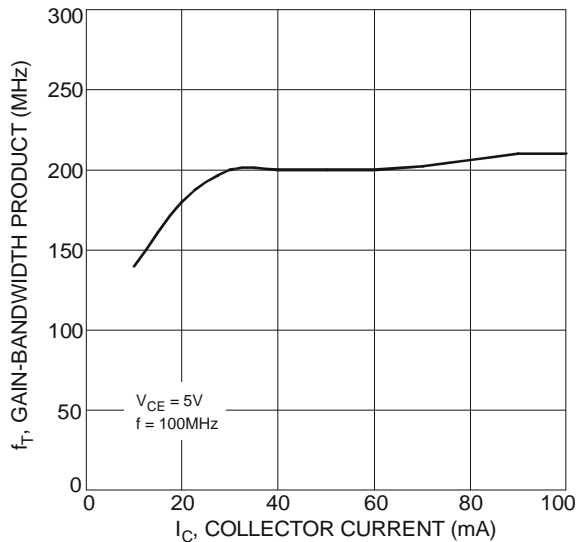
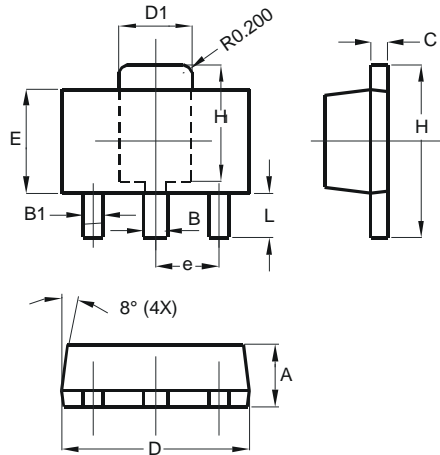


Fig. 7 Typical Gain-Bandwidth Product vs. Collector Current

Package Outline Dimensions

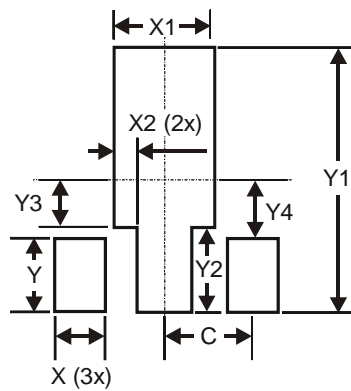
Please see AP02002 at <http://www.diodes.com/datasheets/ap02002.pdf> for latest version.



SOT89		
Dim	Min	Max
A	1.40	1.60
B	0.44	0.62
B1	0.35	0.54
C	0.35	0.44
D	4.40	4.60
D1	1.62	1.83
E	2.29	2.60
e	1.50 Typ	
H	3.94	4.25
H1	2.63	2.93
L	0.89	1.20
All Dimensions in mm		

Suggested Pad Layout

Please see AP02001 at <http://www.diodes.com/datasheets/ap02001.pdf> for the latest version.



Dimensions	Value (in mm)
X	0.900
X1	1.733
X2	0.416
Y	1.300
Y1	4.600
Y2	1.475
Y3	0.950
Y4	1.125
C	1.500

IMPORTANT NOTICE

DIODES INCORPORATED MAKES NO WARRANTY OF ANY KIND, EXPRESS OR IMPLIED, WITH REGARDS TO THIS DOCUMENT, INCLUDING, BUT NOT LIMITED TO, THE IMPLIED WARRANTIES OF MERCHANTABILITY AND FITNESS FOR A PARTICULAR PURPOSE (AND THEIR EQUIVALENTS UNDER THE LAWS OF ANY JURISDICTION).

Diodes Incorporated and its subsidiaries reserve the right to make modifications, enhancements, improvements, corrections or other changes without further notice to this document and any product described herein. Diodes Incorporated does not assume any liability arising out of the application or use of this document or any product described herein; neither does Diodes Incorporated convey any license under its patent or trademark rights, nor the rights of others. Any Customer or user of this document or products described herein in such applications shall assume all risks of such use and will agree to hold Diodes Incorporated and all the companies whose products are represented on Diodes Incorporated website, harmless against all damages.

Diodes Incorporated does not warrant or accept any liability whatsoever in respect of any products purchased through unauthorized sales channel. Should Customers purchase or use Diodes Incorporated products for any unintended or unauthorized application, Customers shall indemnify and hold Diodes Incorporated and its representatives harmless against all claims, damages, expenses, and attorney fees arising out of, directly or indirectly, any claim of personal injury or death associated with such unintended or unauthorized application.

Products described herein may be covered by one or more United States, international or foreign patents pending. Product names and markings noted herein may also be covered by one or more United States, international or foreign trademarks.

This document is written in English but may be translated into multiple languages for reference. Only the English version of this document is the final and determinative format released by Diodes Incorporated.

LIFE SUPPORT

Diodes Incorporated products are specifically not authorized for use as critical components in life support devices or systems without the express written approval of the Chief Executive Officer of Diodes Incorporated. As used herein:

A. Life support devices or systems are devices or systems which:

1. are intended to implant into the body, or
2. support or sustain life and whose failure to perform when properly used in accordance with instructions for use provided in the labeling can be reasonably expected to result in significant injury to the user.

B. A critical component is any component in a life support device or system whose failure to perform can be reasonably expected to cause the failure of the life support device or to affect its safety or effectiveness.

Customers represent that they have all necessary expertise in the safety and regulatory ramifications of their life support devices or systems, and acknowledge and agree that they are solely responsible for all legal, regulatory and safety-related requirements concerning their products and any use of Diodes Incorporated products in such safety-critical, life support devices or systems, notwithstanding any devices- or systems-related information or support that may be provided by Diodes Incorporated. Further, Customers must fully indemnify Diodes Incorporated and its representatives against any damages arising out of the use of Diodes Incorporated products in such safety-critical, life support devices or systems.

Copyright © 2012, Diodes Incorporated

www.diodes.com

Данный компонент на территории Российской Федерации

Вы можете приобрести в компании MosChip.

Для оперативного оформления запроса Вам необходимо перейти по данной ссылке:

<http://moschip.ru/get-element>

Вы можете разместить у нас заказ для любого Вашего проекта, будь то серийное производство или разработка единичного прибора.

В нашем ассортименте представлены ведущие мировые производители активных и пассивных электронных компонентов.

Нашей специализацией является поставка электронной компонентной базы двойного назначения, продукции таких производителей как XILINX, Intel (ex.ALTERA), Vicor, Microchip, Texas Instruments, Analog Devices, Mini-Circuits, Amphenol, Glenair.

Сотрудничество с глобальными дистрибьюторами электронных компонентов, предоставляет возможность заказывать и получать с международных складов практически любой перечень компонентов в оптимальные для Вас сроки.

На всех этапах разработки и производства наши партнеры могут получить квалифицированную поддержку опытных инженеров.

Система менеджмента качества компании отвечает требованиям в соответствии с ГОСТ Р ИСО 9001, ГОСТ РВ 0015-002 и ЭС РД 009

Офис по работе с юридическими лицами:

105318, г.Москва, ул.Щербаковская д.3, офис 1107, 1118, ДЦ «Щербаковский»

Телефон: +7 495 668-12-70 (многоканальный)

Факс: +7 495 668-12-70 (доб.304)

E-mail: info@moschip.ru

Skype отдела продаж:

moschip.ru

moschip.ru_4

moschip.ru_6

moschip.ru_9