



# RF LDMOS Wideband Integrated Power Amplifiers

The A2I25D012N wideband integrated power amplifier is optimized to function with a single multi-band circuit usable from 2300 to 2690 MHz. This multi-stage structure is rated from 26 to 32 V operation and covers all typical cellular base station modulation formats.

- Typical Single-Carrier W-CDMA Characterization Performance:  
 $V_{DD} = 28 \text{ Vdc}$ ,  $I_{DQ1(A+B)} = 45 \text{ mA}$ ,  $I_{DQ2(A+B)} = 110 \text{ mA}$ ,  $P_{out} = 2.2 \text{ W Avg.}$ ,  
Input Signal PAR = 9.9 dB @ 0.01% Probability on CCDF.<sup>(1)</sup>

Frequency	$G_{ps}$ (dB)	PAE (%)	ACPR (dBc)
2300 MHz	31.8	18.5	-47.8
2350 MHz	31.8	18.4	-48.7
2400 MHz	31.9	18.3	-49.3
2496 MHz	32.2	18.3	-49.8
2590 MHz	32.5	18.6	-48.3
2690 MHz	33.2	19.8	-46.8

## Features

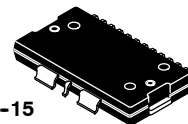
- On-Chip Matching (50 Ohm Input, DC Blocked)
- Integrated Quiescent Current Temperature Compensation with Enable/Disable Function <sup>(2)</sup>
- Designed for Digital Predistortion Error Correction Systems
- Optimized for Doherty Applications

## A2I25D012NR1 A2I25D012GNR1

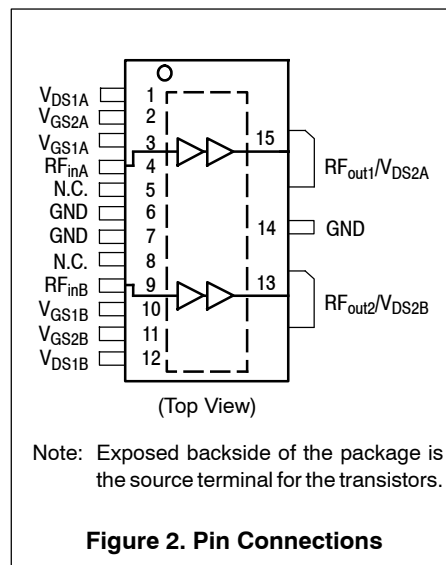
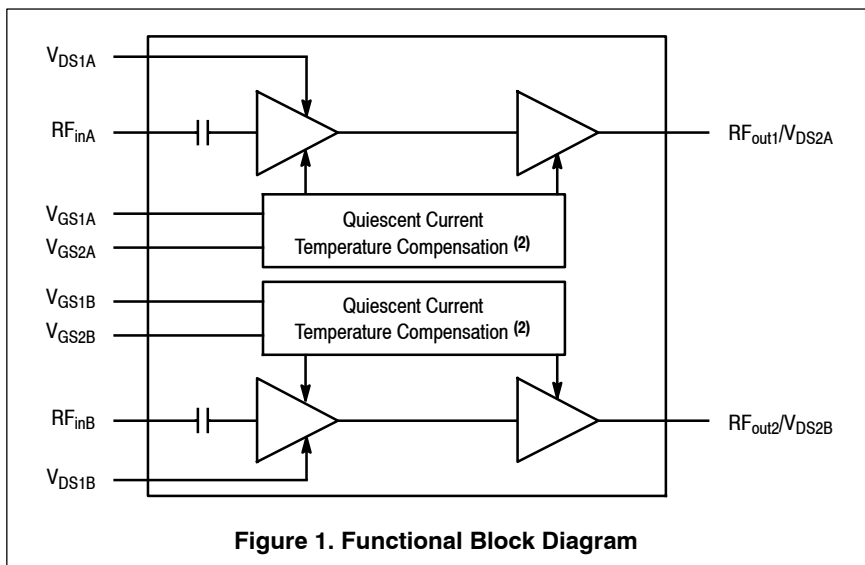
**2300–2690 MHz, 2.2 W AVG., 28 V  
AIRFAST RF LDMOS WIDEBAND  
INTEGRATED POWER AMPLIFIERS**



**TO-270WB-15  
PLASTIC  
A2I25D012NR1**



**TO-270WBG-15  
PLASTIC  
A2I25D012GNR1**



1. All data measured in fixture with device soldered to heatsink.  
2. Refer to AN1977, *Quiescent Current Thermal Tracking Circuit in the RF Integrated Circuit Family*, and to AN1987, *Quiescent Current Control for the RF Integrated Circuit Device Family*. Go to <http://www.freescale.com/rf>. Select Documentation/Application Notes - AN1977 or AN1987.

**Table 1. Maximum Ratings**

Rating	Symbol	Value	Unit
Drain-Source Voltage	$V_{DSS}$	-0.5, +65	Vdc
Gate-Source Voltage	$V_{GS}$	-0.5, +10	Vdc
Operating Voltage	$V_{DD}$	32, +0	Vdc
Storage Temperature Range	$T_{stg}$	-65 to +150	°C
Case Operating Temperature Range	$T_C$	-40 to +150	°C
Operating Junction Temperature Range (1,2)	$T_J$	-40 to +225	°C
Input Power	$P_{in}$	20	dBm

**Table 2. Thermal Characteristics**

Characteristic	Symbol	Value (2,3)	Unit
Thermal Resistance, Junction to Case Case Temperature 74°C, 2 W CW, 2500 MHz Stage 1, 28 Vdc, $I_{DQ1(A+B)} = 45$ mA Stage 2, 28 Vdc, $I_{DQ2(A+B)} = 110$ mA	$R_{\theta JC}$	9.3 3.3	°C/W

**Table 3. ESD Protection Characteristics**

Test Methodology	Class
Human Body Model (per JESD22-A114)	1A
Machine Model (per EIA/JESD22-A115)	A
Charge Device Model (per JESD22-C101)	II

**Table 4. Moisture Sensitivity Level**

Test Methodology	Rating	Package Peak Temperature	Unit
Per JESD22-A113, IPC/JEDEC J-STD-020	3	260	°C

**Table 5. Electrical Characteristics** ( $T_A = 25^\circ\text{C}$  unless otherwise noted)

Characteristic	Symbol	Min	Typ	Max	Unit
<b>Stage 1 - Off Characteristics</b>					
Zero Gate Voltage Drain Leakage Current ( $V_{DS} = 65$ Vdc, $V_{GS} = 0$ Vdc)	$I_{DSS}$	—	—	10	$\mu\text{Adc}$
Zero Gate Voltage Drain Leakage Current ( $V_{DS} = 32$ Vdc, $V_{GS} = 0$ Vdc)	$I_{DSS}$	—	—	1	$\mu\text{Adc}$
Gate-Source Leakage Current ( $V_{GS} = 1.0$ Vdc, $V_{DS} = 0$ Vdc)	$I_{GSS}$	—	—	1	$\mu\text{Adc}$
<b>Stage 1 - On Characteristics</b>					
Gate Threshold Voltage ( $V_{DS} = 10$ Vdc, $I_D = 3$ $\mu\text{Adc}$ )	$V_{GS(th)}$	0.8	1.2	1.6	Vdc
Gate Quiescent Voltage ( $V_{DS} = 28$ Vdc, $I_{DQ1(A+B)} = 45$ mA)	$V_{GS(Q)}$	—	2.0	—	Vdc
Fixture Gate Quiescent Voltage ( $V_{DD} = 28$ Vdc, $I_{DQ1(A+B)} = 45$ mA, Measured in Functional Test)	$V_{GG(Q)}$	5.3	6.7	8.0	Vdc

1. Continuous use at maximum temperature will affect MTTF.
2. MTTF calculator available at <http://www.freescale.com/rf>. Select Software & Tools/Development Tools/Calculators to access MTTF calculators by product.
3. Refer to AN1955, *Thermal Measurement Methodology of RF Power Amplifiers*. Go to <http://www.freescale.com/rf>. Select Documentation/Application Notes - AN1955.

(continued)

**Table 5. Electrical Characteristics** ( $T_A = 25^\circ\text{C}$  unless otherwise noted) (continued)

Characteristic	Symbol	Min	Typ	Max	Unit
<b>Stage 2 - Off Characteristics</b> (1)					
Zero Gate Voltage Drain Leakage Current ( $V_{DS} = 65\text{ Vdc}$ , $V_{GS} = 0\text{ Vdc}$ )	$I_{DSS}$	—	—	10	$\mu\text{Adc}$
Zero Gate Voltage Drain Leakage Current ( $V_{DS} = 32\text{ Vdc}$ , $V_{GS} = 0\text{ Vdc}$ )	$I_{DSS}$	—	—	1	$\mu\text{Adc}$
Gate-Source Leakage Current ( $V_{GS} = 1.0\text{ Vdc}$ , $V_{DS} = 0\text{ Vdc}$ )	$I_{GSS}$	—	—	1	$\mu\text{Adc}$

**Stage 2 - On Characteristics**

Gate Threshold Voltage (1) ( $V_{DS} = 10\text{ Vdc}$ , $I_D = 10\ \mu\text{Adc}$ )	$V_{GS(th)}$	0.8	1.2	1.6	Vdc
Gate Quiescent Voltage ( $V_{DS} = 28\text{ Vdc}$ , $I_{DQ2(A+B)} = 110\text{ mA}$ )	$V_{GS(Q)}$	—	1.9	—	Vdc
Fixture Gate Quiescent Voltage ( $V_{DD} = 28\text{ Vdc}$ , $I_{DQ2(A+B)} = 110\text{ mA}$ , Measured in Functional Test)	$V_{GG(Q)}$	4.0	5.0	6.0	Vdc
Drain-Source On-Voltage (1) ( $V_{GS} = 10\text{ Vdc}$ , $I_D = 100\text{ mA}$ )	$V_{DS(on)}$	0.1	0.32	1.5	Vdc

**Functional Tests** (2,3) (In Freescale Production Test Fixture, 50 ohm system)  $V_{DD} = 28\text{ Vdc}$ ,  $I_{DQ1(A+B)} = 45\text{ mA}$ ,  $I_{DQ2(A+B)} = 110\text{ mA}$ ,  $P_{out} = 2.2\text{ W Avg.}$ ,  $f = 2690\text{ MHz}$ , Single-Carrier W-CDMA, IQ Magnitude Clipping, Input Signal PAR = 9.9 dB @ 0.01% Probability on CCDF.

Power Gain	$G_{ps}$	31.0	32.4	35.0	dB
Power Added Efficiency	PAE	18.0	19.7	—	%
$P_{out}$ @ 1 dB Compression Point, CW	P1dB	13.5	15.5	—	W

**Load Mismatch** (4) (In Freescale Characterization Test Fixture, 50 ohm system)  $I_{DQ1(A+B)} = 45\text{ mA}$ ,  $I_{DQ2(A+B)} = 110\text{ mA}$ ,  $f = 2690\text{ MHz}$

VSWR 10:1 at 32 Vdc, 24 W CW Output Power (3 dB Input Overdrive from 13 W CW Rated Power)	No Device Degradation
----------------------------------------------------------------------------------------------	-----------------------

**Typical Performance** (4) (In Freescale Characterization Test Fixture, 50 ohm system)  $V_{DD} = 28\text{ Vdc}$ ,  $I_{DQ1(A+B)} = 45\text{ mA}$ ,  $I_{DQ2(A+B)} = 110\text{ mA}$ , 2300–2690 MHz Bandwidth

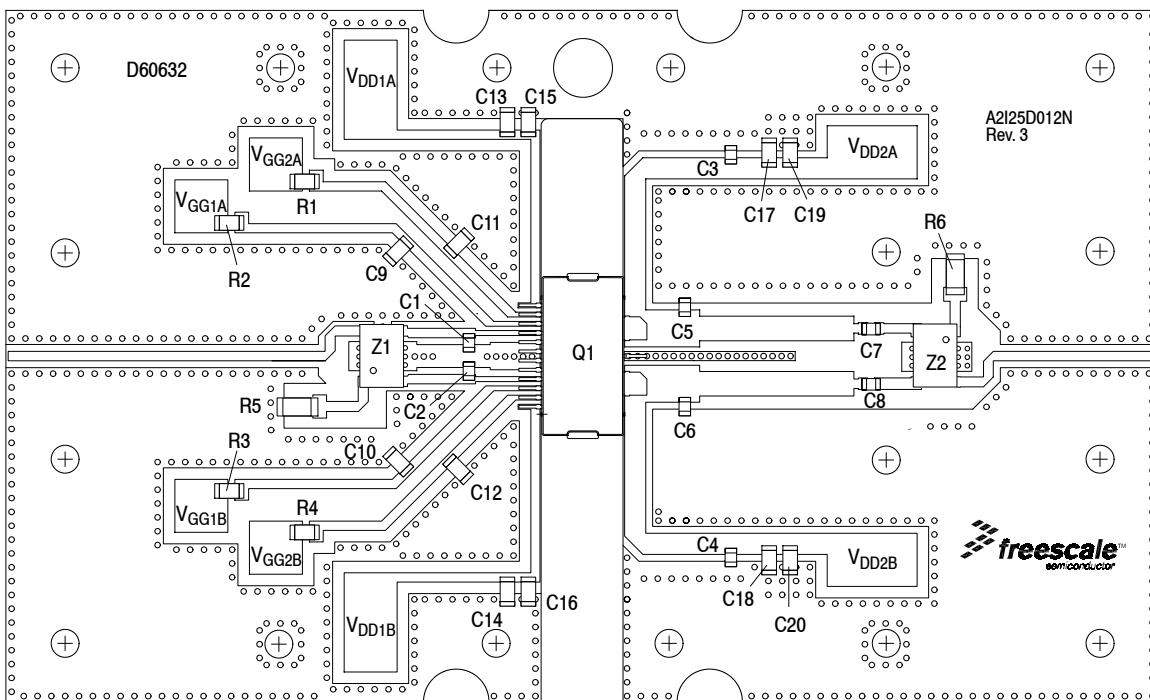
$P_{out}$ @ 3 dB Compression Point, CW (5)	P3dB	—	24	—	W
AM/PM (Maximum value measured at the P3dB compression point across the 2300–2690 MHz frequency range.)	$\Phi$	—	–11.1	—	°
VBW Resonance Point (IMD Third Order Intermodulation Inflection Point)	$VBW_{res}$	—	160	—	MHz
Quiescent Current Accuracy over Temperature (6) with 4.7 k $\Omega$ Gate Feed Resistors (–30 to 85°C)      Stage 1 with 4.7 k $\Omega$ Gate Feed Resistors (–30 to 85°C)      Stage 2	$\Delta I_{QT}$	—	2.77 1.83	—	%
Gain Flatness in 390 MHz Bandwidth @ $P_{out} = 2.2\text{ W Avg.}$	$G_F$	—	1.4	—	dB
Gain Variation over Temperature (–30°C to +85°C)	$\Delta G$	—	0.033	—	dB/°C
Output Power Variation over Temperature (–30°C to +85°C)	$\Delta P1dB$	—	0.006	—	dB/°C

**Table 6. Ordering Information**

Device	Tape and Reel Information	Package
A2I25D012NR1	R1 Suffix = 500 Units, 44 mm Tape Width, 13-Reel	TO-270WB-15
A2I25D012GNR1		TO-270WBG-15

- Each side of device measured separately.
- Part internally input matched.
- Measurements made with device in straight lead configuration before any lead forming operation is applied. Lead forming is used for gull wing (GN) parts.
- All data measured in fixture with device soldered to heatsink.
- $P3dB = P_{avg} + 7.0\text{ dB}$  where  $P_{avg}$  is the average output power measured using an unclipped W-CDMA single-carrier input signal where output PAR is compressed to 7.0 dB @ 0.01% probability on CCDF.
- Refer to AN1977, *Quiescent Current Thermal Tracking Circuit in the RF Integrated Circuit Family*, and to AN1987, *Quiescent Current Control for the RF Integrated Circuit Device Family*. Go to <http://www.freescale.com/rf>. Select Documentation/Application Notes - AN1977 or AN1987.

**A2I25D012NR1 A2I25D012GNR1**



Note: All data measured in fixture with device soldered to heatsink. Production fixture does not include device soldered to heatsink.

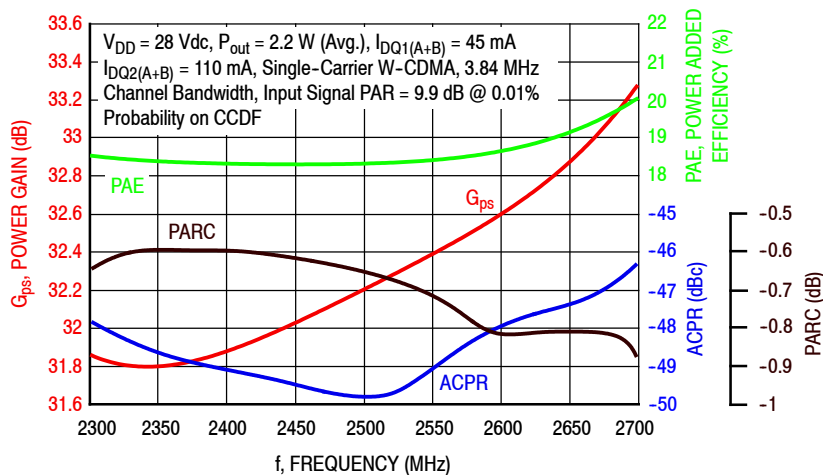
**Figure 3. A2I25D012NR1 Characterization Test Circuit Component Layout — 2300–2690 MHz**

**Table 7. A2I25D012NR1 Test Circuit Component Designations and Values — 2300–2690 MHz**

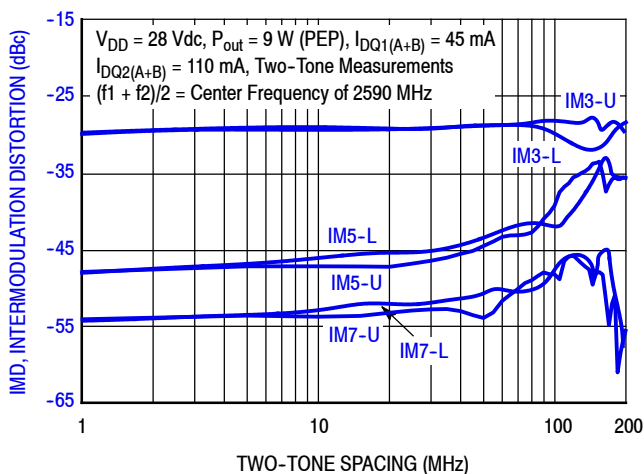
Part	Description	Part Number	Manufacturer
C1, C2	1.1 pF Chip Capacitors	ATC600F1R1AW250XT	ATC
C3, C4	6.8 pF Chip Capacitors	ATC600F6R8BW250XT	ATC
C5, C6	1.8 pF Chip Capacitors	ATC600F1R8AWT250XT	ATC
C7, C8	10 pF Chip Capacitors	ATC600F100JT250XT	ATC
C9, C10, C11, C12, C17, C18	4.7 $\mu$ F Chip Capacitors	GRM31CR71H475KA12L	Murata
C13, C14, C19, C20	10 $\mu$ F Chip Capacitors	GRM31CR61H106KA12L	Murata
C15, C16	1.0 $\mu$ F Chip Capacitors	GRM31MR71H105KA88L	Murata
Q1	RF LDMOS Power Amplifier	A2I25D012NR1	Freescale
R1, R4	4.7 K $\Omega$ , 1/4 W Chip Resistors	CRCW12064K70FKEA	Vishay
R2*, R3*	2.4 K $\Omega$ , 1/4 W Chip Resistors	CRCW12062K40FKEA	Vishay
R5, R6	50 $\Omega$ , 4 W Chip Resistors	CW12010T0050GBK	ATC
Z1, Z2	2300–2900 MHz Band, 90°, 3 dB Hybrid Couplers	X3C26P1-03S	Anaren
PCB	Rogers RO4350B, 0.020", $\epsilon_r = 3.66$	D60632	MTL

\*In production fixture only.

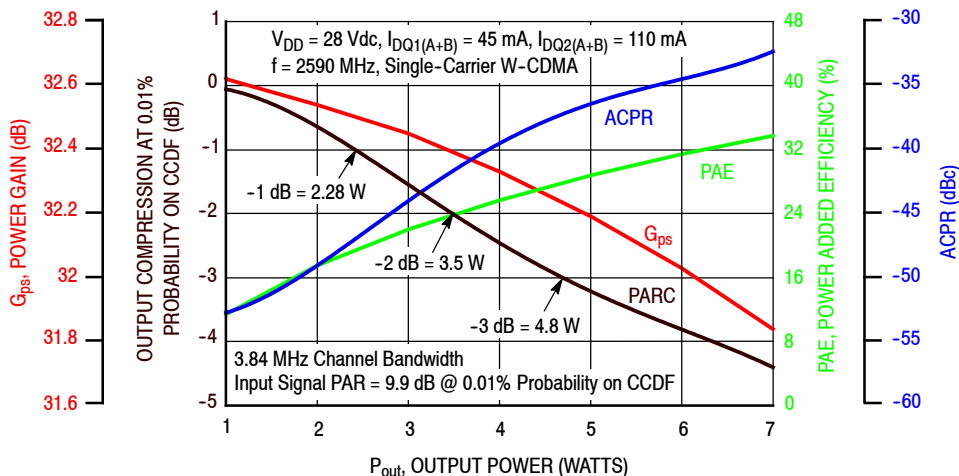
### TYPICAL CHARACTERISTICS



**Figure 4. Single-Carrier Output Peak-to-Average Ratio Compression (PARC) Broadband Performance @  $P_{out} = 2.2$  Watts Avg.**

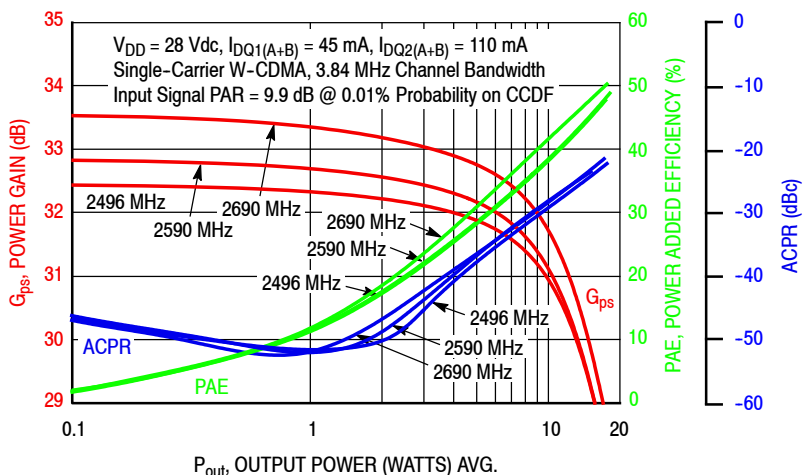


**Figure 5. Intermodulation Distortion Products versus Two-Tone Spacing**

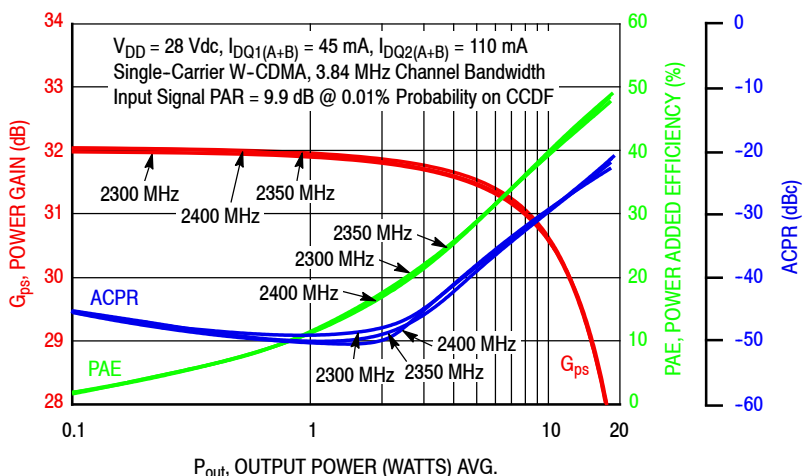


**Figure 6. Output Peak-to-Average Ratio Compression (PARC) versus Output Power**

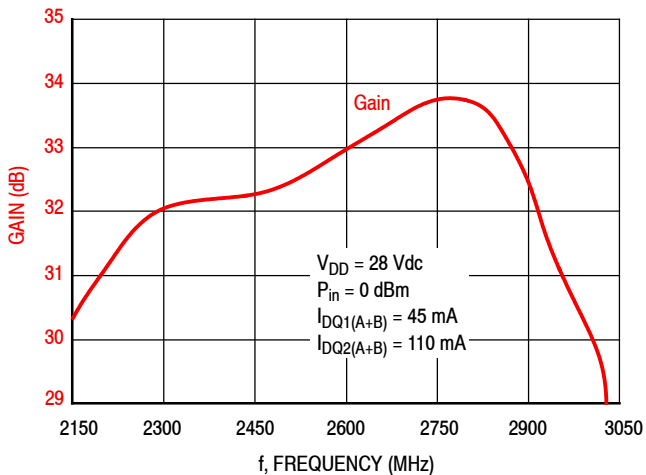
### TYPICAL CHARACTERISTICS



**Figure 7. Single-Carrier W-CDMA Power Gain, Power Added Efficiency and ACPR versus Output Power — 2496–2690 MHz**



**Figure 8. Single-Carrier W-CDMA Power Gain, Power Added Efficiency and ACPR versus Output Power — 2300–2400 MHz**



**Figure 9. Broadband Frequency Response**

**Table 8. Load Pull Performance — Maximum Power Tuning**

$V_{DD} = 28 \text{ Vdc}$ ,  $I_{DQ1(A)} = 22.5 \text{ mA}$ ,  $I_{DQ2(A)} = 55 \text{ mA}$ , Pulsed CW,  $10 \mu\text{sec(on)}$ , 10% Duty Cycle

f (MHz)	$Z_{\text{source}} (\Omega)$	$Z_{\text{in}} (\Omega)$	Max Output Power					
			P1dB					
			$Z_{\text{load}}^{(1)} (\Omega)$	Gain (dB)	(dBm)	(W)	PAE (%)	AM/PM (°)
2300	$20.5 + j19.7$	$19.8 - j20.5$	$9.60 - j0.52$	31.3	40.3	11	54.9	-3
2350	$24.5 + j16.0$	$23.6 - j16.1$	$8.79 - j0.88$	31.7	40.2	10	53.9	-3
2400	$30.8 + j8.79$	$29.5 - j11.3$	$7.87 - j1.08$	32.1	40.1	10	54.1	-4
2496	$45.1 + j5.61$	$43.9 - j9.82$	$8.92 - j1.11$	32.5	40.1	10	53.3	-3
2590	$52.3 + j22.1$	$55.9 - j21.5$	$8.86 - j1.91$	33.1	40.2	11	55.0	-2
2690	$46.0 + j43.0$	$42.9 - j35.7$	$10.1 - j2.57$	33.2	40.3	11	55.1	-3

f (MHz)	$Z_{\text{source}} (\Omega)$	$Z_{\text{in}} (\Omega)$	Max Output Power					
			P3dB					
			$Z_{\text{load}}^{(2)} (\Omega)$	Gain (dB)	(dBm)	(W)	PAE (%)	AM/PM (°)
2300	$20.5 + j19.7$	$20.6 - j21.0$	$10.4 - j1.17$	29.0	41.2	13	55.9	-6
2350	$24.5 + j16.0$	$24.6 - j17.1$	$9.88 - j1.42$	29.3	41.1	13	55.1	-6
2400	$30.8 + j8.79$	$30.6 - j13.3$	$9.77 - j1.59$	29.6	41.1	13	55.1	-7
2496	$45.1 + j5.61$	$43.4 - j12.7$	$10.1 - j1.50$	30.2	41.1	13	55.2	-6
2590	$52.3 + j22.1$	$52.8 - j23.3$	$10.4 - j2.22$	30.7	41.2	13	55.6	-5
2690	$46.0 + j43.0$	$41.0 - j35.0$	$11.5 - j2.97$	30.9	41.2	13	56.0	-5

(1) Load impedance for optimum P1dB power.

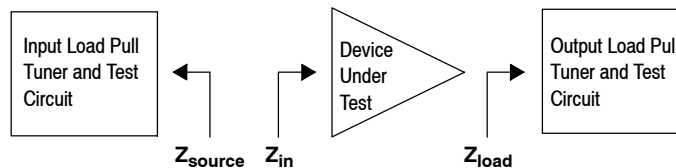
(2) Load impedance for optimum P3dB power.

$Z_{\text{source}}$  = Measured impedance presented to the input of the device at the package reference plane.

$Z_{\text{in}}$  = Impedance as measured from gate contact to ground.

$Z_{\text{load}}$  = Measured impedance presented to the output of the device at the package reference plane.

**Note: Measurement made on a per side basis.**



**Table 9. Load Pull Performance — Maximum Power Added Efficiency Tuning**

$V_{DD} = 28$  Vdc,  $I_{DQ1(A)} = 22.5$  mA,  $I_{DQ2(A)} = 55$  mA, Pulsed CW, 10  $\mu$ sec(on), 10% Duty Cycle

f (MHz)	$Z_{source}$ ( $\Omega$ )	$Z_{in}$ ( $\Omega$ )	Max Power Added Efficiency					
			P1dB					
			$Z_{load}^{(1)}$ ( $\Omega$ )	Gain (dB)	(dBm)	(W)	PAE (%)	AM/PM ( $^{\circ}$ )
2300	20.5 + j19.7	20.8 – j18.5	5.29 + j2.95	33.3	38.7	7	62.6	–8
2350	24.5 + j16.0	24.8 – j13.5	5.06 + j2.20	33.7	38.8	8	61.9	–8
2400	30.8 + j8.79	32.4 – j8.18	4.95 + j2.11	34.2	38.6	7	60.8	–8
2496	45.1 + j5.61	50.5 – j8.00	5.25 + j1.60	34.5	38.9	8	60.6	–7
2590	52.3 + j22.1	61.3 – j27.8	5.42 + j1.07	34.9	39.0	8	61.9	–7
2690	46.0 + j43.0	42.1 – j41.4	5.33 – j0.09	35.2	38.8	8	62.2	–8

f (MHz)	$Z_{source}$ ( $\Omega$ )	$Z_{in}$ ( $\Omega$ )	Max Power Added Efficiency					
			P3dB					
			$Z_{load}^{(2)}$ ( $\Omega$ )	Gain (dB)	(dBm)	(W)	PAE (%)	AM/PM ( $^{\circ}$ )
2300	20.5 + j19.7	21.2 – j19.2	5.18 + j2.83	31.3	39.4	9	63.6	–13
2350	24.5 + j16.0	25.5 – j14.7	5.15 + j2.29	31.7	39.6	9	63.3	–12
2400	30.8 + j8.79	32.7 – j10.3	5.16 + j2.22	32.2	39.5	9	63.0	–12
2496	45.1 + j5.61	50.1 – j10.8	4.96 + j1.89	32.8	39.4	9	62.9	–12
2590	52.3 + j22.1	57.9 – j27.9	5.33 + j1.26	33.0	39.7	9	63.5	–9
2690	46.0 + j43.0	40.9 – j39.8	5.33 + j0.11	33.2	39.5	9	63.7	–10

(1) Load impedance for optimum P1dB efficiency.

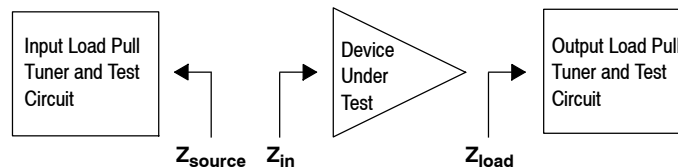
(2) Load impedance for optimum P3dB efficiency.

$Z_{source}$  = Measured impedance presented to the input of the device at the package reference plane.

$Z_{in}$  = Impedance as measured from gate contact to ground.

$Z_{load}$  = Measured impedance presented to the output of the device at the package reference plane.

**Note: Measurement made on a per side basis.**





### P1dB - TYPICAL LOAD PULL CONTOURS — 2590 MHz

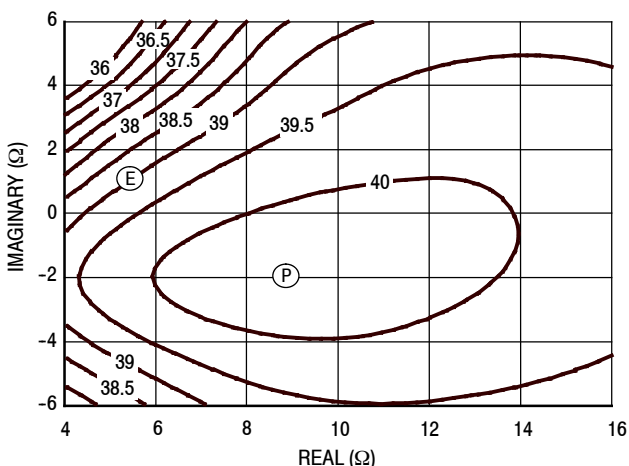


Figure 10. P1dB Load Pull Output Power Contours (dBm)

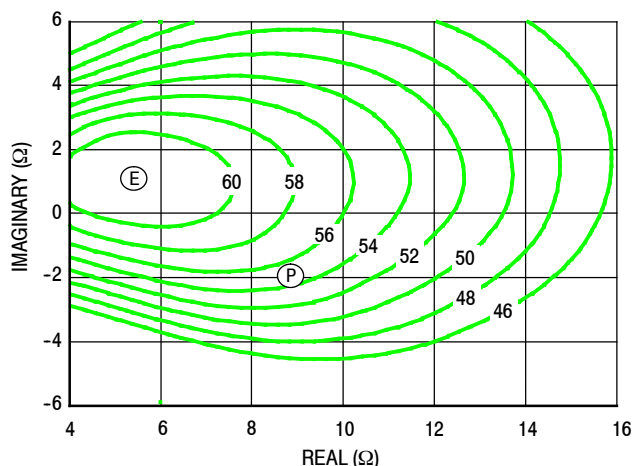


Figure 11. P1dB Load Pull Efficiency Contours (%)

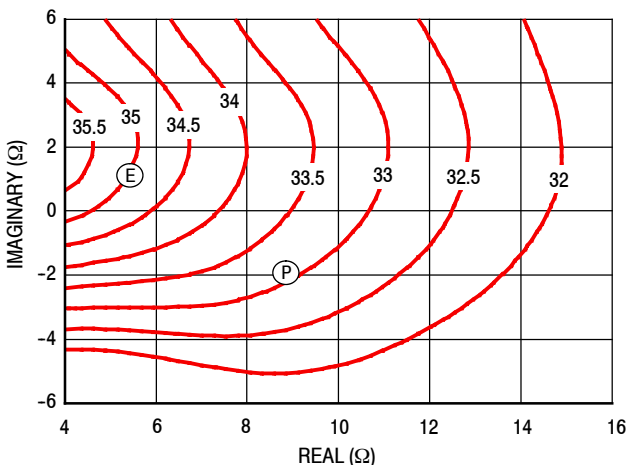


Figure 12. P1dB Load Pull Gain Contours (dB)

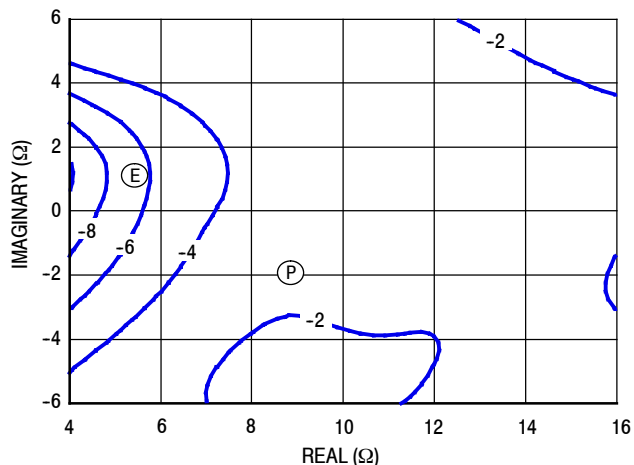


Figure 13. P1dB Load Pull AM/PM Contours (°)

**NOTE:** (P) = Maximum Output Power

(E) = Maximum Power Added Efficiency

- Gain
- Power Added Efficiency
- Linearity
- Output Power

### P3dB - TYPICAL LOAD PULL CONTOURS — 2590 MHz

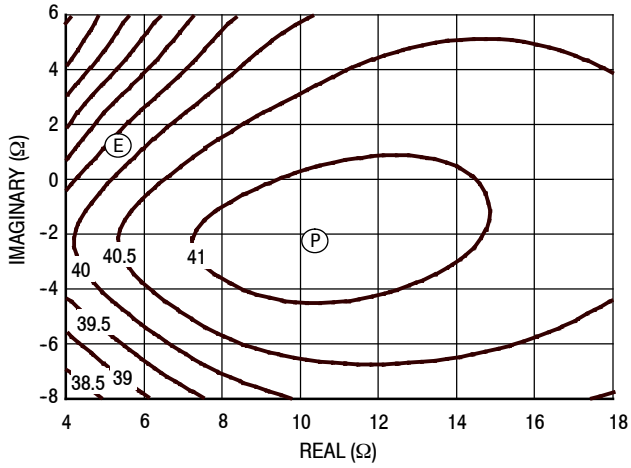


Figure 14. P3dB Load Pull Output Power Contours (dBm)

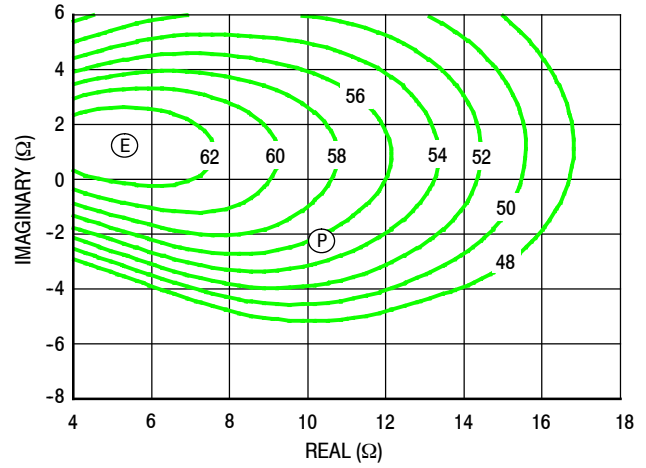


Figure 15. P3dB Load Pull Efficiency Contours (%)

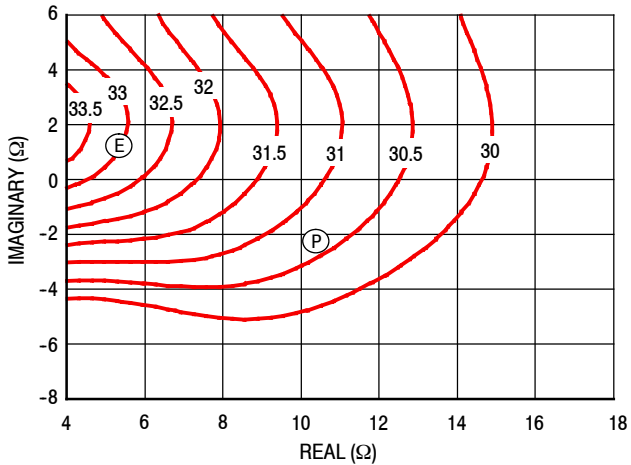


Figure 16. P3dB Load Pull Gain Contours (dB)

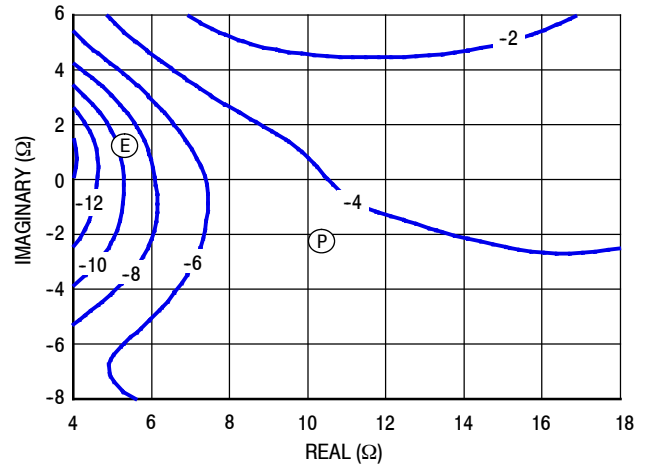


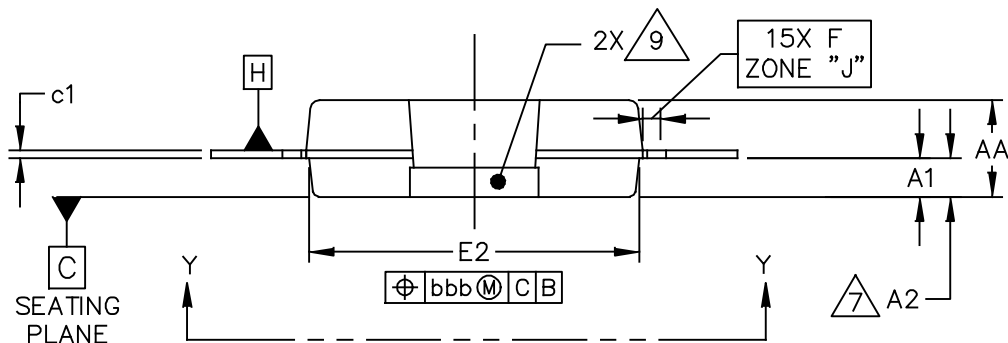
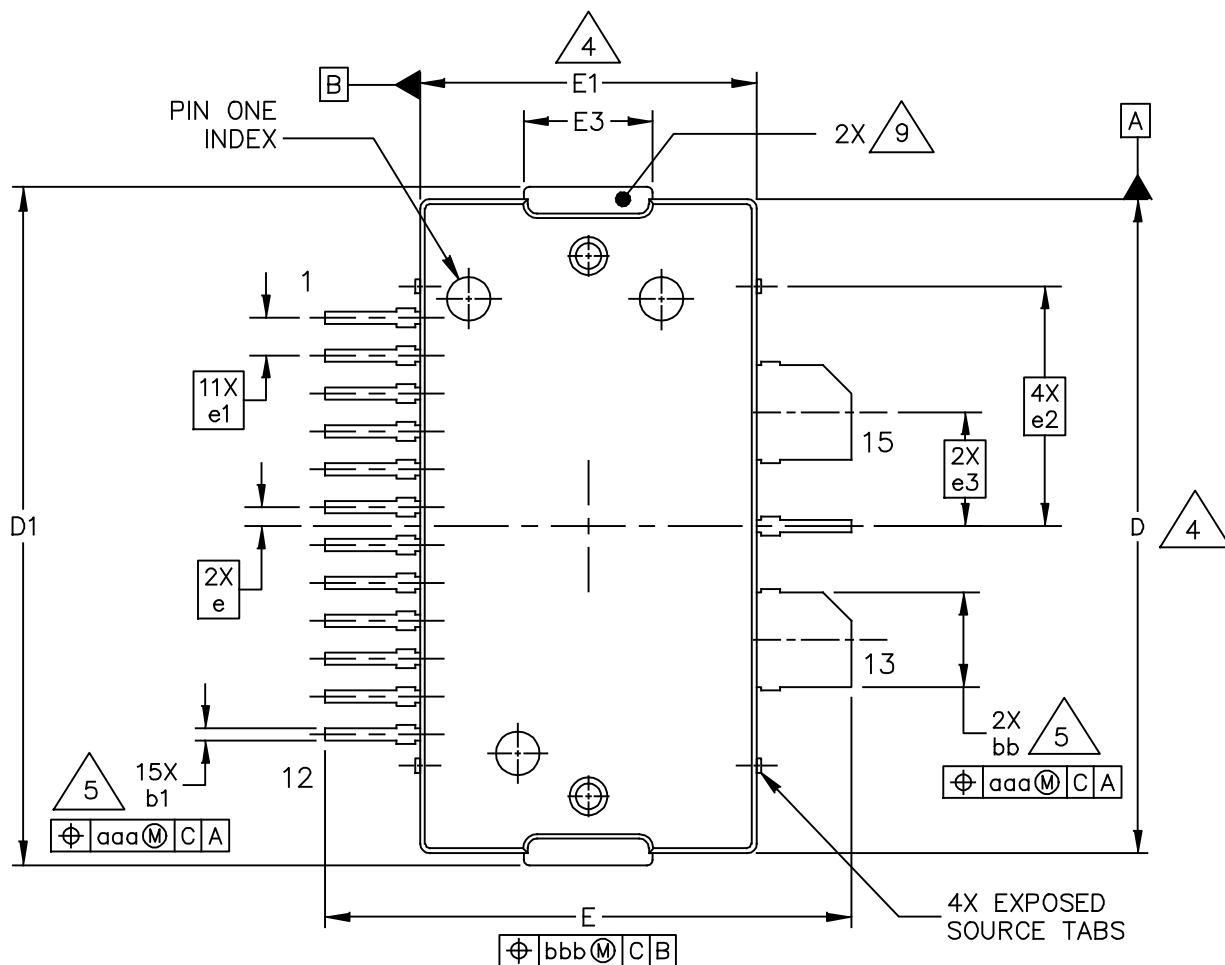
Figure 17. P3dB Load Pull AM/PM Contours (°)

NOTE: (P) = Maximum Output Power

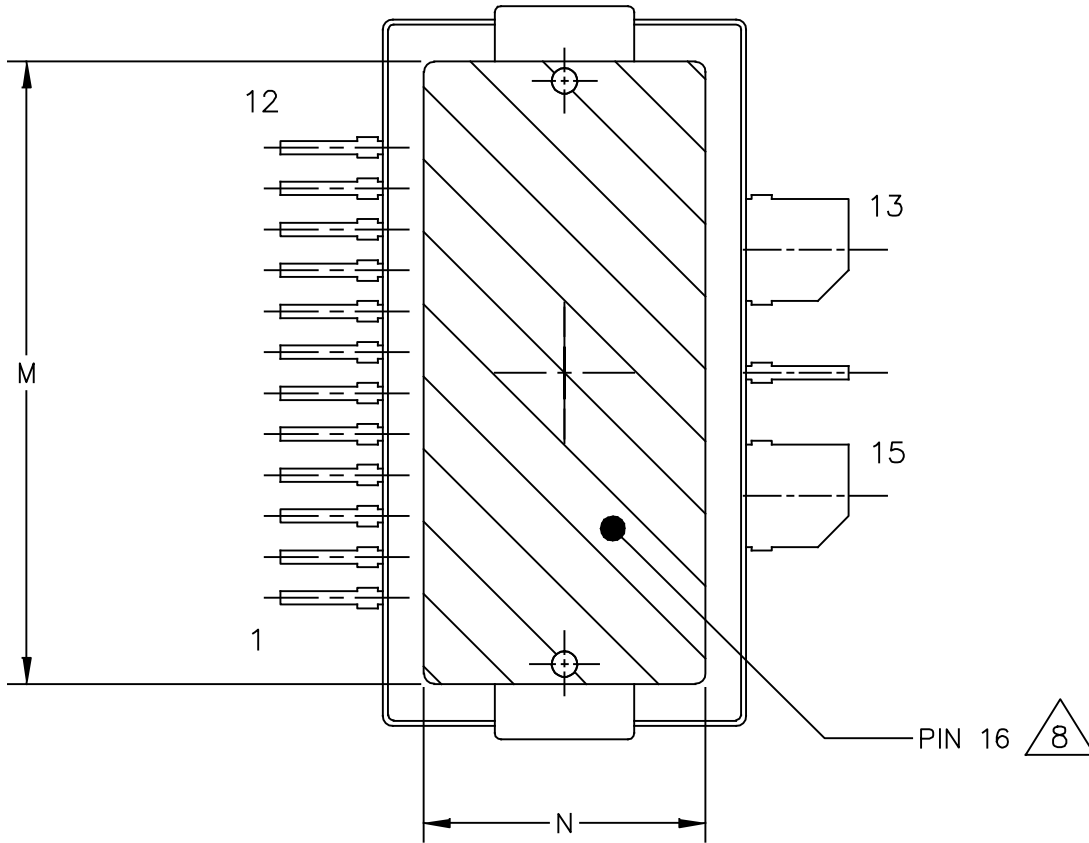
(E) = Maximum Power Added Efficiency

- Gain
- Power Added Efficiency
- Linearity
- Output Power

### PACKAGE DIMENSIONS



© FREESCALE SEMICONDUCTOR, INC. ALL RIGHTS RESERVED.	MECHANICAL OUTLINE	PRINT VERSION NOT TO SCALE
TITLE:  TO-270WB-15	DOCUMENT NO: 98ASA00630D      REV: 0	
STANDARD: NON-JEDEC		17 JUN 2014



VIEW Y-Y

© FREESCALE SEMICONDUCTOR, INC. ALL RIGHTS RESERVED.	MECHANICAL OUTLINE	PRINT VERSION NOT TO SCALE
TITLE:  TO-270WB-15	DOCUMENT NO: 98ASA00630D      REV: 0	
	STANDARD: NON-JEDEC	
	17 JUN 2014	

NOTES:

1. CONTROLLING DIMENSION: INCH
2. INTERPRET DIMENSIONS AND TOLERANCES PER ASME Y14.5M–1994.
3. DATUM PLANE H IS LOCATED AT THE TOP OF LEAD AND IS COINCIDENT WITH THE LEAD WHERE THE LEAD EXITS THE PLASTIC BODY AT THE TOP OF THE PARTING LINE.

4. DIMENSIONS D AND E1 DO NOT INCLUDE MOLD PROTRUSION. ALLOWABLE PROTRUSION IS .006 INCH (0.15 MM) PER SIDE. DIMENSIONS D AND E1 DO INCLUDE MOLD MISMATCH AND ARE DETERMINED AT DATUM PLANE H.

5. DIMENSIONS bb AND b1 DO NOT INCLUDE DAMBAR PROTRUSION. ALLOWABLE DAMBAR PROTRUSION SHALL BE .005 INCH (0.13 MM) TOTAL IN EXCESS OF THE bb AND b1 DIMENSIONS AT MAXIMUM MATERIAL CONDITION.

6. DATUMS A AND B TO BE DETERMINED AT DATUM PLANE H.

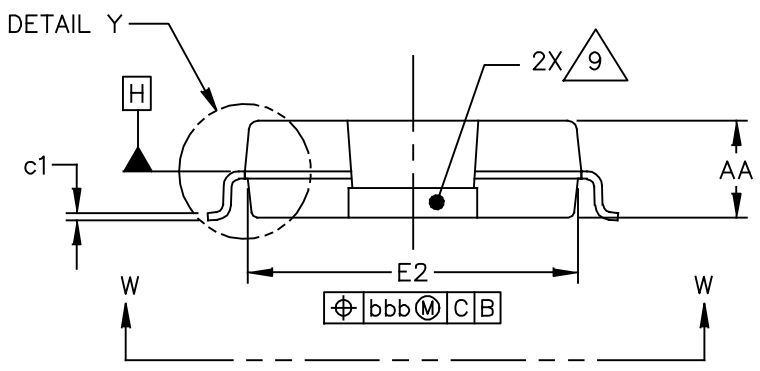
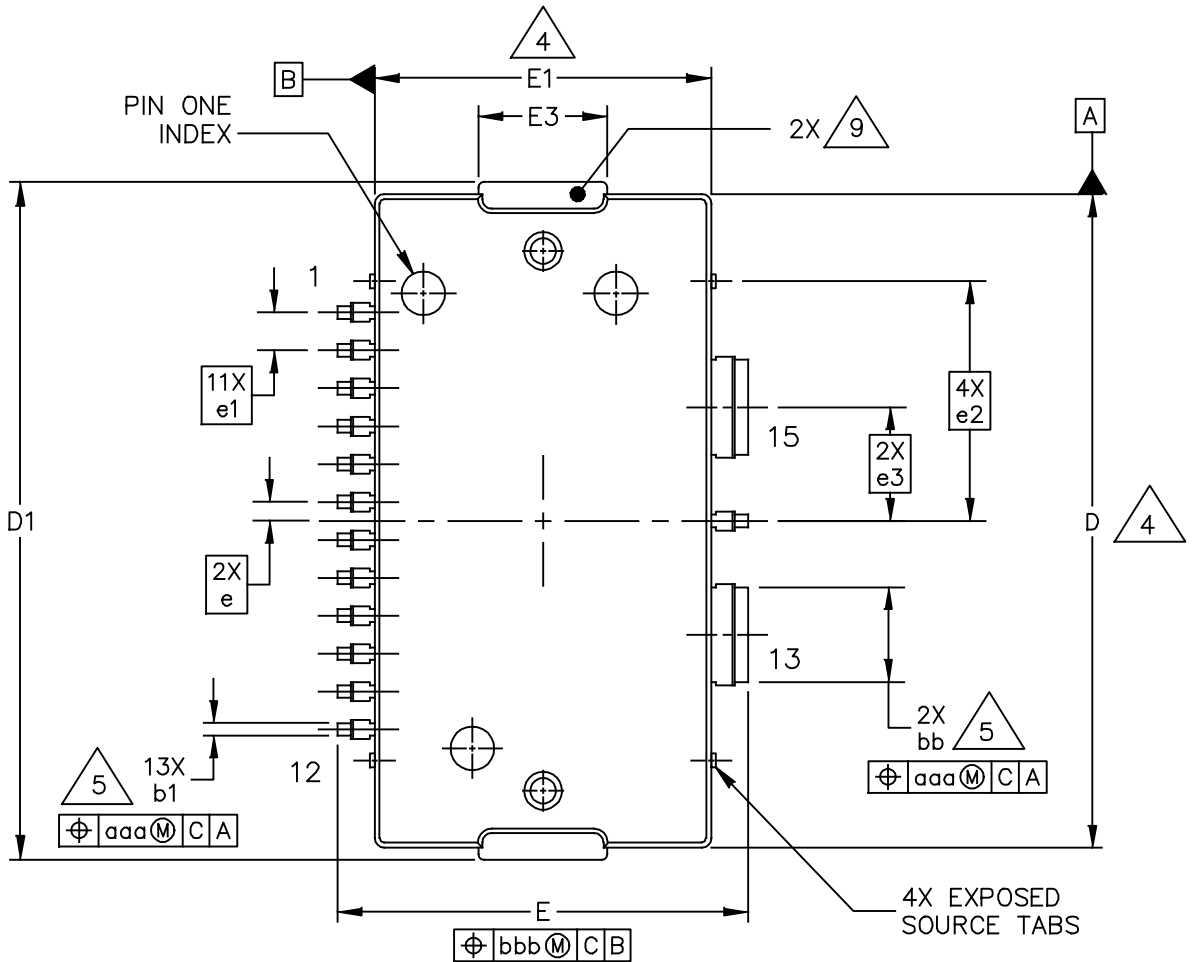
7. DIMENSION A2 APPLIES WITHIN ZONE J ONLY.

8. HATCHING REPRESENTS THE EXPOSED AND SOLDERABLE AREA OF THE HEAT SLUG. DIMENSIONS M AND N REPRESENT THE VALUES BETWEEN THE TWO OPPOSITE POINTS ALONG THE EDGES OF EXPOSED AREA OF THE HEAT SLUG.

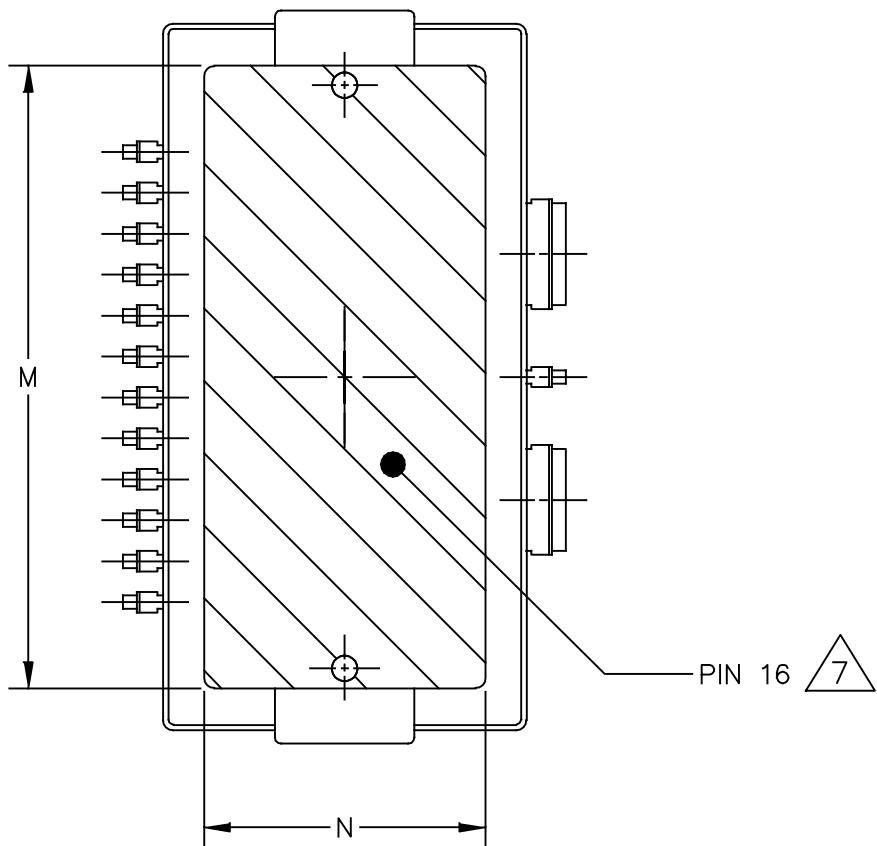
9. THESE SURFACES OF THE HEAT SLUG ARE NOT PART OF THE SOLDERABLE SURFACES AND MAY REMAIN UNPLATED.

DIM	INCH		MILLIMETER		DIM	INCH		MILLIMETER	
	MIN	MAX	MIN	MAX		MIN	MAX	MIN	MAX
AA	.099	.105	2.51	2.67	M	.600	----	15.24	----
A1	.039	.043	0.99	1.09	N	.270	----	6.86	----
A2	.040	.042	1.02	1.07	bb	.097	.103	2.46	2.62
D	.688	.692	17.48	17.58	b1	.010	.016	0.25	0.41
D1	.712	.720	18.08	18.29	c1	.007	.011	0.18	0.28
E	.551	.559	14.00	14.20	e	.020 BSC		0.51 BSC	
E1	.353	.357	8.97	9.07	e1	.040 BSC		1.02 BSC	
E2	.346	.350	8.79	8.89	e2	.253 INFO ONLY		6.43 INFO ONLY	
E3	.132	.140	3.35	3.56	e3	.120 BSC		3.05 BSC	
F	.025 BSC		0.64 BSC		aaa	.004		0.10	
					bbb	.008		0.20	

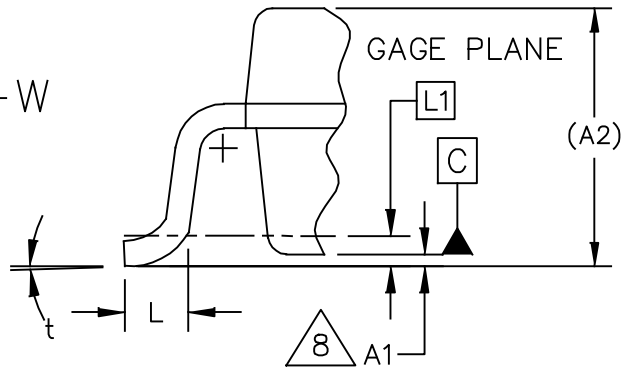
© FREESCALE SEMICONDUCTOR, INC. ALL RIGHTS RESERVED.		MECHANICAL OUTLINE		PRINT VERSION NOT TO SCALE	
TITLE:  TO-270WB-15			DOCUMENT NO: 98ASA00630D		REV: 0
			STANDARD: NON-JEDEC		
			17 JUN 2014		



© FREESCALE SEMICONDUCTOR, INC. ALL RIGHTS RESERVED.	MECHANICAL OUTLINE	PRINT VERSION NOT TO SCALE
TITLE:  TO-270WBG-15	DOCUMENT NO: 98ASA00684D STANDARD: NON-JEDEC	REV: 0
		17 JUN 2014



VIEW W-W



DETAIL "Y"

© FREESCALE SEMICONDUCTOR, INC. ALL RIGHTS RESERVED.	MECHANICAL OUTLINE	PRINT VERSION NOT TO SCALE
TITLE:  TO-270WBG-15	DOCUMENT NO: 98ASA00684D	REV: 0
	STANDARD: NON-JEDEC	
	17 JUN 2014	

NOTES:

1. CONTROLLING DIMENSION: INCH
2. INTERPRET DIMENSIONS AND TOLERANCES PER ASME Y14.5M-1994.
3. DATUM PLANE H IS LOCATED AT THE TOP OF LEAD AND IS COINCIDENT WITH THE LEAD WHERE THE LEAD EXITS THE PLASTIC BODY AT THE TOP OF THE PARTING LINE.
4. DIMENSIONS D AND E1 DO NOT INCLUDE MOLD PROTRUSION. ALLOWABLE PROTRUSION IS .006 INCH (0.15 MM) PER SIDE. DIMENSIONS D AND E1 DO INCLUDE MOLD MISMATCH AND ARE DETERMINED AT DATUM PLANE H.
5. DIMENSIONS bb AND b1 DO NOT INCLUDE DAMBAR PROTRUSION. ALLOWABLE DAMBAR PROTRUSION SHALL BE .005 INCH (0.13 MM) TOTAL IN EXCESS OF THE bb AND b1 DIMENSIONS AT MAXIMUM MATERIAL CONDITION.
6. DATUMS A AND B TO BE DETERMINED AT DATUM PLANE H.
7. HATCHING REPRESENTS THE EXPOSED AND SOLDERABLE AREA OF THE HEAT SLUG. DIMENSIONS M AND N REPRESENT THE VALUES BETWEEN THE TWO OPPOSITE POINTS ALONG THE EDGES OF EXPOSED AREA OF THE HEAT SLUG.
8. DIMENSION A1 IS MEASURED WITH REFERENCE TO DATUM C. THE POSITIVE VALUE IMPLIES THAT THE BOTTOM OF THE PACKAGE IS HIGHER THAN THE BOTTOM OF THE LEAD.
9. THESE SURFACES OF THE HEAT SLUG ARE NOT PART OF THE SOLDERABLE SURFACES AND MAY REMAIN UNPLATED.

DIM	INCH		MILLIMETER		DIM	INCH		MILLIMETER	
	MIN	MAX	MIN	MAX		MIN	MAX	MIN	MAX
AA	.099	.105	2.51	2.67	M	.600	----	15.24	----
A1	.001	.004	0.03	0.10	N	.270	----	6.86	----
A2	(.105)		(2.67)		bb	.097	.103	2.46	2.62
D	.688	.692	17.48	17.58	b1	.010	.016	0.25	0.41
D1	.712	.720	18.08	18.29	c1	.007	.011	0.18	0.28
E	.429	.437	10.90	11.10	e	.020 BSC		0.51 BSC	
E1	.353	.357	8.97	9.07	e1	.040 BSC		1.02 BSC	
E2	.346	.350	8.79	8.89	e2	.253 INFO ONLY		6.43 INFO ONLY	
E3	.132	.140	3.35	3.56	e3	.120 BSC		3.05 BSC	
L	.018	.024	0.46	0.61	t	2'	8'	2'	8'
L1	.010 BSC		0.25 BSC		aaa	.004		0.10	
					bbb	.008		0.20	

© FREESCALE SEMICONDUCTOR, INC. ALL RIGHTS RESERVED.		MECHANICAL OUTLINE	PRINT VERSION NOT TO SCALE
TITLE:  TO-270WBG-15		DOCUMENT NO: 98ASA00684D      REV: 0	
		STANDARD: NON-JEDEC	
		17 JUN 2014	



Refer to the following resources to aid your design process.

**Application Notes**

- AN1955: Thermal Measurement Methodology of RF Power Amplifiers
- AN1977: Quiescent Current Thermal Tracking Circuit in the RF Integrated Circuit Family
- AN1987: Quiescent Current Control for the RF Integrated Circuit Device Family

**Engineering Bulletins**

- EB212: Using Data Sheet Impedances for RF LDMOS Devices

**Software**

- Electromigration MTTF Calculator
- RF High Power Model
- .s2p File

**Development Tools**

- Printed Circuit Boards

For Software and Tools, do a Part Number search at <http://www.freescale.com>, and select the “Part Number” link. Go to Software & Tools on the part’s Product Summary page to download the respective tool.

**REVISION HISTORY**

The following table summarizes revisions to this document.

Revision	Date	Description
0	Sept. 2014	<ul style="list-style-type: none"> <li>• Initial release of data sheet</li> </ul>
1	Mar. 2015	<ul style="list-style-type: none"> <li>• Figs. 4, 6–8: changed drain efficiency to power added efficiency for plots and axes labels, pp. 5, 6</li> <li>• Tables 7 and 8: changed drain efficiency to power added efficiency and added measurement made on a per side basis note, pp. 7, 8</li> </ul>

### ***How to Reach Us:***

**Home Page:**  
[freescale.com](http://freescale.com)

**Web Support:**  
[freescale.com/support](http://freescale.com/support)

Information in this document is provided solely to enable system and software implementers to use Freescale products. There are no express or implied copyright licenses granted hereunder to design or fabricate any integrated circuits based on the information in this document.

Freescale reserves the right to make changes without further notice to any products herein. Freescale makes no warranty, representation, or guarantee regarding the suitability of its products for any particular purpose, nor does Freescale assume any liability arising out of the application or use of any product or circuit, and specifically disclaims any and all liability, including without limitation consequential or incidental damages. "Typical" parameters that may be provided in Freescale data sheets and/or specifications can and do vary in different applications, and actual performance may vary over time. All operating parameters, including "typicals," must be validated for each customer application by customer's technical experts. Freescale does not convey any license under its patent rights nor the rights of others. Freescale sells products pursuant to standard terms and conditions of sale, which can be found at the following address: [freescale.com/SalesTermsandConditions](http://freescale.com/SalesTermsandConditions).

Freescale and the Freescale logo are trademarks of Freescale Semiconductor, Inc., Reg. U.S. Pat. & Tm. Off. Airfast is a trademark of Freescale Semiconductor, Inc. All other product or service names are the property of their respective owners.

© 2014–2015 Freescale Semiconductor, Inc.

## Данный компонент на территории Российской Федерации

### Вы можете приобрести в компании MosChip.

Для оперативного оформления запроса Вам необходимо перейти по данной ссылке:

<http://moschip.ru/get-element>

Вы можете разместить у нас заказ для любого Вашего проекта, будь то серийное производство или разработка единичного прибора.

В нашем ассортименте представлены ведущие мировые производители активных и пассивных электронных компонентов.

Нашей специализацией является поставка электронной компонентной базы двойного назначения, продукции таких производителей как XILINX, Intel (ex.ALTERA), Vicor, Microchip, Texas Instruments, Analog Devices, Mini-Circuits, Amphenol, Glenair.

Сотрудничество с глобальными дистрибьюторами электронных компонентов, предоставляет возможность заказывать и получать с международных складов практически любой перечень компонентов в оптимальные для Вас сроки.

На всех этапах разработки и производства наши партнеры могут получить квалифицированную поддержку опытных инженеров.

Система менеджмента качества компании отвечает требованиям в соответствии с ГОСТ Р ИСО 9001, ГОСТ РВ 0015-002 и ЭС РД 009

### Офис по работе с юридическими лицами:

105318, г.Москва, ул.Щербаковская д.3, офис 1107, 1118, ДЦ «Щербаковский»

Телефон: +7 495 668-12-70 (многоканальный)

Факс: +7 495 668-12-70 (доб.304)

E-mail: [info@moschip.ru](mailto:info@moschip.ru)

Skype отдела продаж:

moschip.ru

moschip.ru\_4

moschip.ru\_6

moschip.ru\_9