

## Schottky Rectifier, 2.1 A

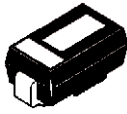

SMA

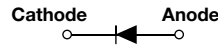

### FEATURES

- Small foot print, surface mountable
- Low forward voltage drop
- High frequency operation
- Guard ring for enhanced ruggedness and long term reliability
- Meets MSL level 1, per J-STD-020, LF maximum peak of 260 °C
- Compliant to RoHS directive 2002/95/EC
- Designed and qualified for industrial level

**RoHS**  
COMPLIANT

### PRODUCT SUMMARY

|             |       |
|-------------|-------|
| $I_{F(AV)}$ | 2.1 A |
| $V_R$       | 60 V  |

### DESCRIPTION

The VS-10MQ060NPbF surface mount Schottky rectifier has been designed for applications requiring low forward drop and very small foot prints on PC boards. Typical applications are in disk drives, switching power supplies, converters, freewheeling diodes, battery charging, and reverse battery protection.

### MAJOR RATINGS AND CHARACTERISTICS

| SYMBOL      | CHARACTERISTICS                             | VALUES      | UNITS            |
|-------------|---|-------------|------------------|
| $I_{F(AV)}$ | DC  | 2.1         | A                |
| $V_{RRM}$   |   | 60          | V                |
| $I_{FSM}$   | $t_p = 5 \mu s$ sine                        | 40          | A                |
| $V_F$       | 1.5 Apk, $T_J = 125 \text{ }^\circ\text{C}$ | 0.63        | V                |
| $T_J$       | Range                                       | - 55 to 150 | $^\circ\text{C}$ |

### VOLTAGE RATINGS

| PARAMETER                            | SYMBOL    | VS-10MQ060NPbF | UNITS |
|--------------------------------------|-----------|----------------|-------|
| Maximum DC reverse voltage           | $V_R$     | 60             | V     |
| Maximum working peak reverse voltage | $V_{RWM}$ |                |       |

### ABSOLUTE MAXIMUM RATINGS

| PARAMETER  | SYMBOL      | TEST CONDITIONS  | VALUES | UNITS |
|--|-------------|--|--------|-------|
| Maximum average forward current<br>See fig. 4                        | $I_{F(AV)}$ | 50 % duty cycle at $T_L = 120 \text{ }^\circ\text{C}$ , rectangular waveform<br>On PC board 9 mm <sup>2</sup> island<br>(0.013 mm thick copper pad area) | 1.5    | A     |
| Maximum peak one cycle<br>non-repetitive surge current<br>See fig. 6 | $I_{FSM}$   | 5 $\mu s$ sine or 3 $\mu s$ rect. pulse  | 40     | A     |
|  |             | 10 ms sine or 6 ms rect. pulse   |        |       |
| Non-repetitive avalanche energy                                      | $E_{AS}$    | $T_J = 25 \text{ }^\circ\text{C}$ , $I_{AS} = 1 \text{ A}$ , $L = 4 \text{ mH}$  | 2.0    | mJ    |
| Repetitive avalanche current   | $I_{AR}$    | Current decaying linearly to zero in 1 $\mu s$<br>Frequency limited by $T_J$ maximum $V_A = 1.5 \times V_R$ typical                                      | 1.0    | A     |

| ELECTRICAL SPECIFICATIONS                     |                |   |                                   |        |            |
|---|----------------|---|-----------------------------------|--------|------------|
| PARAMETER                                     | SYMBOL         | TEST CONDITIONS   |                                   | VALUES | UNITS      |
| Maximum forward voltage drop<br>See fig. 1    | $V_{FM}^{(1)}$ | 1 A   | $T_J = 25\text{ }^\circ\text{C}$  | 0.63   | V          |
|   |                | 1.5 A   |                                   | 0.71   |            |
|   |                | 1 A   | $T_J = 125\text{ }^\circ\text{C}$ | 0.57   |            |
|   |                | 1.5 A   |                                   | 0.63   |            |
| Maximum reverse leakage current<br>See fig. 2 | $I_{RM}^{(1)}$ | $T_J = 25\text{ }^\circ\text{C}$  | $V_R = \text{Rated } V_R$         | 0.5    | mA         |
|   |                | $T_J = 125\text{ }^\circ\text{C}$   |                                   | 7.5    |            |
| Threshold voltage                             | $V_{F(TO)}$    | $T_J = T_J \text{ maximum}$   |                                   | 0.45   | V          |
| Forward slope resistance                      | $r_t$          |   |                                   | 86.8   | m $\Omega$ |
| Typical junction capacitance                  | $C_T$          | $V_R = 10\text{ }V_{DC}$ , $T_J = 25\text{ }^\circ\text{C}$ , test signal = 1 MHz |                                   | 31     | pF         |
| Typical series inductance                     | $L_S$          | Measured lead to lead 5 mm from package body                                      |                                   | 2.0    | nH         |
| Maximum voltage rate of change                | dV/dt          | Rated $V_R$   |                                   | 10 000 | V/ $\mu$ s |

**Note**

(1) Pulse width < 300  $\mu$ s, duty cycle < 2 %

| THERMAL - MECHANICAL SPECIFICATIONS             |                         |                               |  |             |                    |
|---|-------------------------|-------------------------------|--|-------------|--------------------|
| PARAMETER                                       | SYMBOL                  | TEST CONDITIONS               |  | VALUES      | UNITS              |
| Maximum junction and storage temperature range  | $T_J^{(1)}$ , $T_{Stg}$ |                               |  | - 55 to 150 | $^\circ\text{C}$   |
| Maximum thermal resistance, junction to ambient | $R_{thJA}$              | DC operation                  |  | 80          | $^\circ\text{C/W}$ |
| Approximate weight                              |                         |                               |  | 0.07        | g                  |
|   |                         |                               |  | 0.002       | oz.                |
| Marking device                                  |                         | Case style SMA (similar D-64) |  | V1H         |                    |

**Note**

(1)  $\frac{dP_{tot}}{dT_J} < \frac{1}{R_{thJA}}$  thermal runaway condition for a diode on its own heatsink

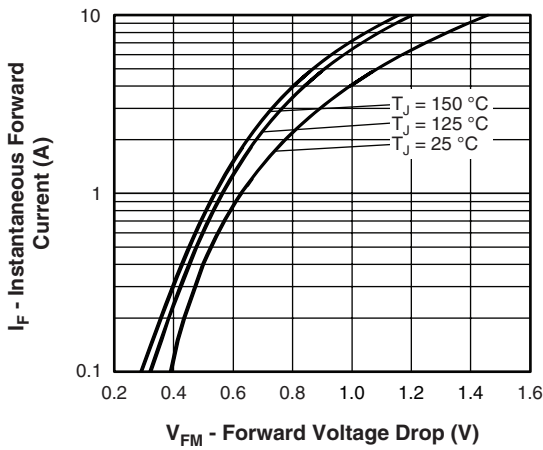

Fig. 1 - Maximum Forward Voltage Drop Characteristics

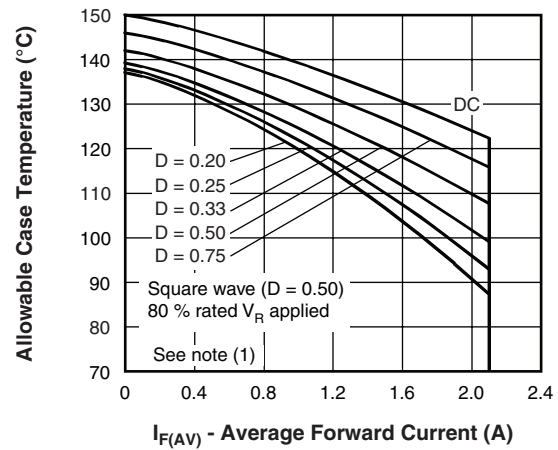

Fig. 4 - Maximum Average Forward Current vs. Allowable Lead Temperature

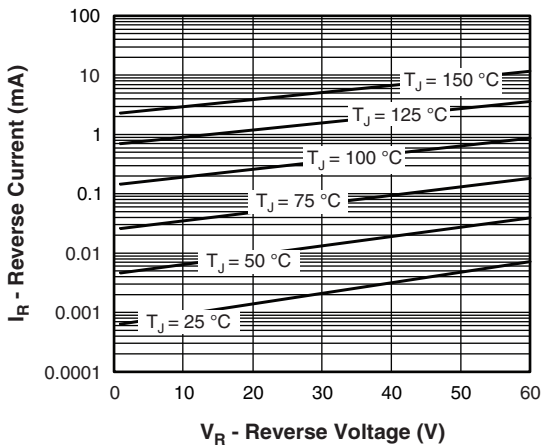

Fig. 2 - Typical Peak Reverse Current vs. Reverse Voltage

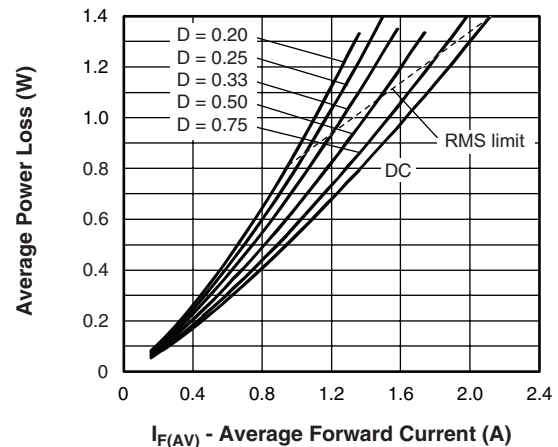

Fig. 5 - Maximum Average Forward Dissipation vs. Average Forward Current

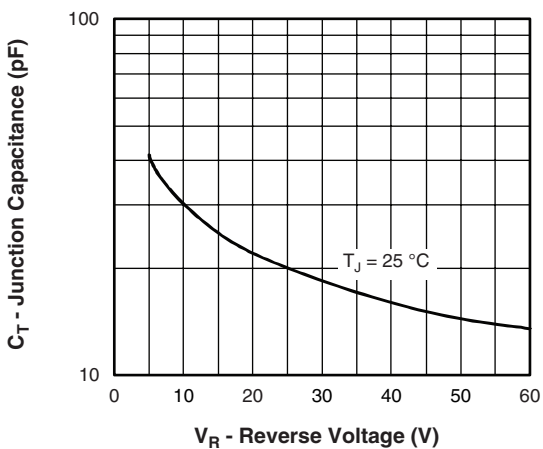

Fig. 3 - Typical Junction Capacitance vs. Reverse Voltage

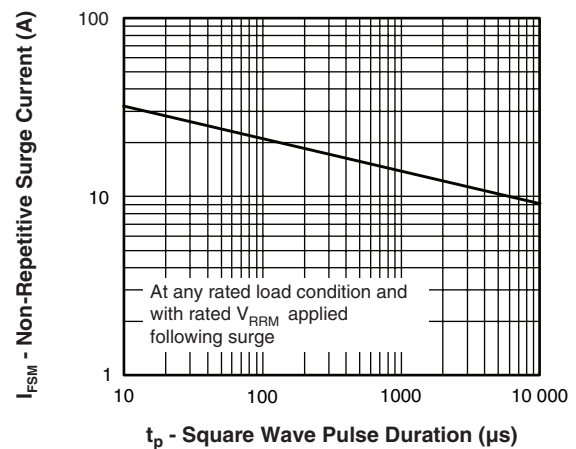
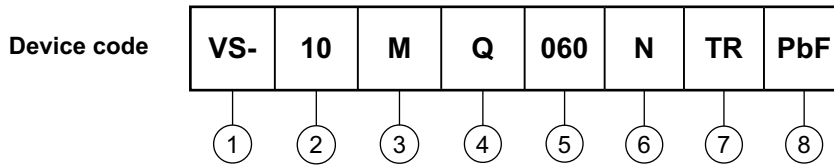

Fig. 6 - Maximum Peak Surge Forward Current vs. Pulse Duration

**Note**

(1) Formula used:  $T_C = T_J - (Pd + Pd_{REV}) \times R_{thJC}$ ;  
 $Pd$  = Forward power loss =  $I_{F(AV)} \times V_{FM}$  at  $(I_{F(AV)}/D)$  (see fig. 6);  $Pd_{REV}$  = Inverse power loss =  $V_{R1} \times I_R (1 - D)$ ;  $I_R$  at  $V_{R1} = 80\%$  rated  $V_R$

## ORDERING INFORMATION TABLE



- 1** - HPP product suffix
- 2** - Current rating
- 3** - M = SMA
- 4** - Q = Schottky "Q" series
- 5** - Voltage rating (060 = 60 V)
- 6** - N = New SMA
- 7** -
  - None = Box (1000 pieces)
  - TR = Tape and reel (7500 pieces)
- 8** - PbF = Lead (Pb)-free

| LINKS TO RELATED DOCUMENTS |  |
|----------------------------|--|
| Dimensions                 | <a href="http://www.vishay.com/doc?95018">www.vishay.com/doc?95018</a>               |
| Part marking information   | <a href="http://www.vishay.com/doc?95029">www.vishay.com/doc?95029</a>               |
| Packaging information      | Tape and reel <a href="http://www.vishay.com/doc?95034">www.vishay.com/doc?95034</a> |
|                            | Bulk <a href="http://www.vishay.com/doc?95397">www.vishay.com/doc?95397</a>          |

## SMA

**DIMENSIONS** in millimeters (inches)

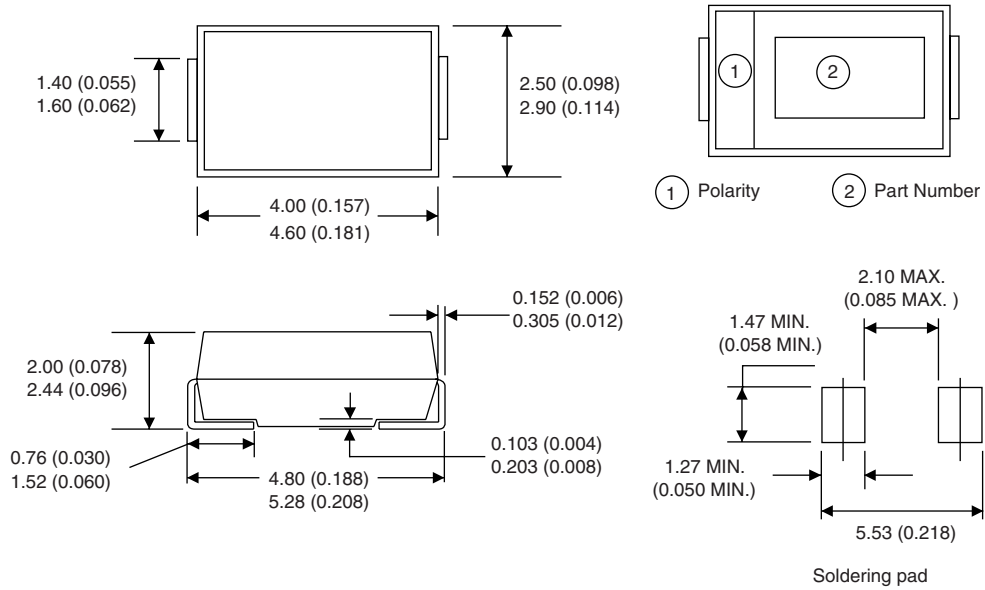



## Disclaimer

ALL PRODUCT, PRODUCT SPECIFICATIONS AND DATA ARE SUBJECT TO CHANGE WITHOUT NOTICE TO IMPROVE RELIABILITY, FUNCTION OR DESIGN OR OTHERWISE.

Vishay Intertechnology, Inc., its affiliates, agents, and employees, and all persons acting on its or their behalf (collectively, "Vishay"), disclaim any and all liability for any errors, inaccuracies or incompleteness contained in any datasheet or in any other disclosure relating to any product.

Vishay makes no warranty, representation or guarantee regarding the suitability of the products for any particular purpose or the continuing production of any product. To the maximum extent permitted by applicable law, Vishay disclaims (i) any and all liability arising out of the application or use of any product, (ii) any and all liability, including without limitation special, consequential or incidental damages, and (iii) any and all implied warranties, including warranties of fitness for particular purpose, non-infringement and merchantability.

Statements regarding the suitability of products for certain types of applications are based on Vishay's knowledge of typical requirements that are often placed on Vishay products in generic applications. Such statements are not binding statements about the suitability of products for a particular application. It is the customer's responsibility to validate that a particular product with the properties described in the product specification is suitable for use in a particular application. Parameters provided in datasheets and/or specifications may vary in different applications and performance may vary over time. All operating parameters, including typical parameters, must be validated for each customer application by the customer's technical experts. Product specifications do not expand or otherwise modify Vishay's terms and conditions of purchase, including but not limited to the warranty expressed therein.

Except as expressly indicated in writing, Vishay products are not designed for use in medical, life-saving, or life-sustaining applications or for any other application in which the failure of the Vishay product could result in personal injury or death. Customers using or selling Vishay products not expressly indicated for use in such applications do so at their own risk and agree to fully indemnify and hold Vishay and its distributors harmless from and against any and all claims, liabilities, expenses and damages arising or resulting in connection with such use or sale, including attorneys fees, even if such claim alleges that Vishay or its distributor was negligent regarding the design or manufacture of the part. Please contact authorized Vishay personnel to obtain written terms and conditions regarding products designed for such applications.

No license, express or implied, by estoppel or otherwise, to any intellectual property rights is granted by this document or by any conduct of Vishay. Product names and markings noted herein may be trademarks of their respective owners.

## Material Category Policy

**Vishay Intertechnology, Inc. hereby certifies that all its products that are identified as RoHS-Compliant fulfill the definitions and restrictions defined under Directive 2011/65/EU of The European Parliament and of the Council of June 8, 2011 on the restriction of the use of certain hazardous substances in electrical and electronic equipment (EEE) - recast, unless otherwise specified as non-compliant.**

**Please note that some Vishay documentation may still make reference to RoHS Directive 2002/95/EC. We confirm that all the products identified as being compliant to Directive 2002/95/EC conform to Directive 2011/65/EU.**

## Данный компонент на территории Российской Федерации

### Вы можете приобрести в компании MosChip.

Для оперативного оформления запроса Вам необходимо перейти по данной ссылке:

<http://moschip.ru/get-element>

Вы можете разместить у нас заказ для любого Вашего проекта, будь то серийное производство или разработка единичного прибора.

В нашем ассортименте представлены ведущие мировые производители активных и пассивных электронных компонентов.

Распределительные склады, находящиеся в России, Европе и в Китае, позволяют нам оперативно поставить необходимые компоненты в оптимальные для Вас сроки.

На всех этапах разработки и производства наши партнеры могут получить квалифицированную поддержку опытных инженеров.

Система менеджмента качества компании отвечает требованиям ISO 9001:2011

### Офис по работе с юридическими лицами:

107023, г.Москва, Семеновский переулок, д.6, Бизнес-центр «АВС»

Телефон: +7 495 668-12-70 (многоканальный)

Факс: +7 495 668-12-70 (доб.304)

E-mail: [info@moschip.ru](mailto:info@moschip.ru)

Skype отдела продаж:

|               |              |
|---------------|--------------|
| moschip.ru_3  | moschip.ru_6 |
| moschip.ru_4  | moschip.ru_7 |
| moschip.ru_11 | moschip.ru_8 |
| moschip.ru_12 | moschip.ru_9 |