

# Intel<sup>®</sup> FM2112 24-Port 10G/1G Ethernet Switch Chip

Data Sheet

---

*April, 2008 (Revision 2.2)*



## Legal

---

INFORMATION IN THIS DOCUMENT IS PROVIDED IN CONNECTION WITH INTEL® PRODUCTS. NO LICENSE, EXPRESS OR IMPLIED, BY ESTOPPEL OR OTHERWISE, TO ANY INTELLECTUAL PROPERTY RIGHTS IS GRANTED BY THIS DOCUMENT. EXCEPT AS PROVIDED IN INTEL'S TERMS AND CONDITIONS OF SALE FOR SUCH PRODUCTS, INTEL ASSUMES NO LIABILITY WHATSOEVER, AND INTEL DISCLAIMS ANY EXPRESS OR IMPLIED WARRANTY, RELATING TO SALE AND/OR USE OF INTEL PRODUCTS INCLUDING LIABILITY OR WARRANTIES RELATING TO FITNESS FOR A PARTICULAR PURPOSE, MERCHANTABILITY, OR INFRINGEMENT OF ANY PATENT, COPYRIGHT OR OTHER INTELLECTUAL PROPERTY RIGHT. Intel products are not intended for use in medical, life saving, life sustaining, critical control or safety systems, or in nuclear facility applications.

Intel may make changes to specifications and product descriptions at any time, without notice.

Intel Corporation may have patents or pending patent applications, trademarks, copyrights, or other intellectual property rights that relate to the presented subject matter. The furnishing of documents and other materials and information does not provide any license, express or implied, by estoppel or otherwise, to any such patents, trademarks, copyrights, or other intellectual property rights.

The Controller may contain design defects or errors known as errata which may cause the product to deviate from published specifications. Current characterized errata are available on request.

Intel and Intel logo are trademarks or registered trademarks of Intel Corporation or its subsidiaries in the United States and other countries.

\*Other names and brands may be claimed as the property of others.

Copyright © 2011. Intel Corporation. All Rights Reserved.



## Table of Contents

---

Overview .....	4
Document Revision History.....	4
Product Applicability.....	4
Other Related Documents and Tools .....	5
<b>1.0 Introduction.....</b>	<b>6</b>
1.1 Product Overview .....	6
1.1.1 Applications.....	6
1.1.2 Features.....	6
1.1.3 Ethernet Interface Flexibility .....	7
1.1.4 Control and Test Interfaces.....	8
1.2 Application Examples .....	8
1.2.1 Advanced TCA Chassis Base Fabric Switch .....	9
1.2.2 Stackable Switch .....	9
1.2.3 2.5 Gigabit Backplane Upgrade.....	10
1.2.4 Applications Summary .....	11
1.3 Supported Standards and Specifications .....	11
1.4 Definitions.....	12
<b>2.0 Architectural Overview .....</b>	<b>13</b>
2.1 Principles of Operation .....	13
2.2 Architectural Partitioning .....	13
<b>3.0 Functional Description .....</b>	<b>16</b>
3.1 Ethernet Port Logic (EPL).....	16
3.1.1 Port and Lane Configuration.....	16
3.1.2 SerDes.....	17
3.1.3 SerDes - Testing with BIST .....	21
3.1.4 PCS .....	22
3.1.5 IFG Stretch (IFGS) .....	24
3.1.6 MAC .....	26
3.2 Frame Control.....	29
3.2.1 MAC Address Security .....	29
3.2.2 IEEE 802.1x - Port Access Control.....	30
3.2.3 VLAN .....	30
3.2.4 Network Topology and Spanning Tree Protocol (STP).....	32
3.2.5 Multicast and Protocol Traps .....	33
3.2.6 MAC Address Table and VLAN Table .....	34
3.2.7 Lookups and Forwarding.....	35
3.2.8 Forwarding .....	36
3.2.9 Discard and Monitoring: User-defined Triggers .....	36
3.2.10 Link-Aggregation.....	38
3.2.11 Table Modification.....	40
3.2.12 Memory Integrity .....	41
3.3 Congestion Management .....	41
3.3.1 Priority Mapping .....	42
3.3.2 Shared Memory Queues .....	43
3.3.3 PWD (Priority Weighted Discard) .....	44
3.3.4 Pause Flow Control .....	46
3.3.5 Egress Scheduling .....	48
3.4 Statistics.....	49
3.5 Management.....	50
3.5.1 Logical CPU Interface .....	52



- 3.5.2 Bootstrap Finite State Machine .....59
- 3.5.3 CPU Interface .....61
- 3.5.4 SPI Interface (EEPROM) .....64
- 3.5.5 LED Interface .....65
- 3.5.6 JTAG .....67
- 3.6 Clocks .....69
  - 3.6.1 SerDes Clocks, RCK[A:B][1:4]P/N .....69
  - 3.6.2 CPU Interface Clock .....69
  - 3.6.3 JTAG Clock .....69
  - 3.6.4 Frame Handler Clock .....70
- 4.0 Electrical Specifications .....71**
  - 4.1 Absolute Maximum Ratings .....71
  - 4.2 Recommended Operating Conditions .....71
  - 4.3 AC Timing Specifications .....73
    - 4.3.1 CPU Interface, General Timing Requirements .....75
    - 4.3.2 JTAG Interface .....76
- 5.0 Register Definitions .....77**
  - 5.1 Register Conventions .....77
  - 5.2 Register Map .....77
  - 5.3 Global Registers .....82
    - 5.3.1 Global Register Tables .....82
  - 5.4 Switch Configuration .....87
    - 5.4.1 Critical Events .....87
    - 5.4.2 System Configuration .....91
    - 5.4.3 Per port Configuration .....95
    - 5.4.4 Non-IEEE 802.3 Header Info .....97
    - 5.4.5 Logical CPU Interface Registers .....97
  - 5.5 Bridge Registers .....99
    - 5.5.1 Switch Control Tables .....99
    - 5.5.2 Port Trunk Registers (Link-Aggregation) .....103
    - 5.5.3 Filtering and Monitoring .....106
  - 5.6 Congestion Management .....107
    - 5.6.1 Priority Mapping .....107
    - 5.6.2 Queue Management - PWD .....109
    - 5.6.3 Switch Latency .....113
  - 5.7 Statistics .....114
    - 5.7.1 Statistics Registers .....115
    - 5.7.2 Counter Groups .....115
  - 5.8 EPL Registers .....121
    - 5.8.1 SERDES Registers .....121
    - 5.8.2 PCS Registers .....126
    - 5.8.3 MAC Registers .....130
    - 5.8.4 Scan Registers .....136
- 6.0 Signal, Ball, and Package Descriptions .....138**
  - 6.1 Package Overview .....138
  - 6.2 Power Mapping .....138
  - 6.3 Interface Mapping .....139
  - 6.4 Signal Descriptions .....139
    - 6.4.1 FM2112 Signals .....140
    - 6.4.2 Recommended Connections .....145
    - 6.4.3 Ball Assignment .....146
  - 6.5 Package Dimensions .....159
  - 6.6 Power Dissipation and Heat Sinking .....161
    - 6.6.1 Power Dissipation .....161

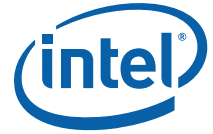

6.6.2	Heat Sinking.....	162
6.6.3	Temperature Sensor Operation.....	163
<b>7.0</b>	<b>Document Revision Information .....</b>	<b>165</b>
7.1	Nomenclature .....	165
7.2	Rev 1.0 to 1.1 Changes .....	165
7.3	Rev 2.0 to 2.1 Changes .....	166
7.4	Rev 2.1 to 2.2 Changes .....	166



## Overview

Intel® intends to offer multiple market- and customer-specific product variants based on the platform. This preliminary data sheet documents the features and functionality of the variant of the Intel® Ethernet Switch Family platform that features eight 10G (quad SerDes) interfaces and sixteen 1G (single SerDes) interfaces, which will be referred to in this document as the FM2112.

*Note:* This document provides information about the FM2112. All specifications are based on pre-production release test data and are subject to change. Rev 2.0 of this datasheet, when released, will contain complete and final specifications and will be available concurrently with the product's production release.

## Document Revision History

Revision	Date	Notes
1.0	Oct 25, 2006	Initial version of Preliminary Datasheet
2.0	July 30, 2007	Updates per section 7.2
2.1	Oct 1, 2007	Updates per section 7.3
2.2	April 17, 2008	Updates per section 7.4

## Product Applicability

This preliminary data sheet documents the features and functionality of the FM2112, the second member of the FM2000 product family. The Intel® Ethernet Switch Family FM2112 part number is structured as follows:

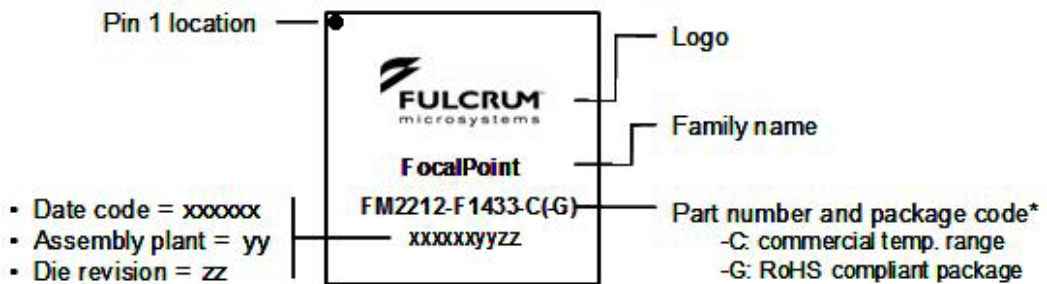

\*Note: Pre-Production part numbering may differ slightly

### Key:

- Product Family: "2" represents the Ethernet L2 switch product family, of which the Intel® Ethernet Switch Family is a member.
- Port Configuration: Provides guidance on the composition of the ports in the device, as follows:



- 1: More than 50% of the interfaces are single-SerDes interfaces
- 2: More than 50% of the interfaces are quad-SerDes interfaces
- Aggregate Bandwidth: "12" represents an aggregate bandwidth of 120Gbps
- Temperature: "C" represents Commercial temperature grade. The grades indicate case temperatures as follows:

Grade	Designator	Tcase(min) (°C)	Tcase(max) (°C)
Commercial	-C	0	+85
Extended	-E	0	+105
Industrial	-I	-40	+115

- RoHS Compliance: The presence of a "-G" means that the device is compliant with the RoHS requirements for restrictions on the use of hazardous substances. Compliance is via exemption #15 in the RoHS Directive Annex, which allows for the use of Pb (lead) in the solder bumps used for die attaché in flip-chip packages. -G parts have lead-free solder balls on the exterior of the package for PC board die attach.

*Note:* The non-RoHS compliant package meets the RoHS limits for the other five substances, but contains Pb in the external solder balls, which is not allowed by the RoHS directive, and in the solder bumps for die attach.

## Other Related Documents and Tools

Other documents that may be useful for evaluating and using the FM2112 include:

- FM2112 Software API Specification
- FM2112 Specification Update, which contains errata and other specification and documentation changes
- FM2112 Design and Layout Guide
- FM2112 Reference Design Data Sheet
- FM2112 Design Support Package on CD



## 1.0 Introduction

### 1.1 Product Overview

The FM2112 is a fully-integrated, single-chip 24-port 10G/2.5G/1G Ethernet layer-2 switch chip that offers wire-speed performance, extremely low-latency characteristics, and leading power efficiency. With its robust layer-2 switching capabilities and the ubiquity of Ethernet, the FM2112 fits comfortably in a number of existing and emerging applications. And, with the unprecedented level of integration, the FM2112 removes the cost, area, and power barrier for rapid and far-reaching high-performance Ethernet deployment.

#### 1.1.1 Applications

With unprecedented integration, performance, power efficiency, and latency characteristics, the FM2112 can be used for a variety of infrastructure and interconnect applications, some of which include:

- Blade computer and IP storage platform internal fabric
- Data center cluster interconnect (clustered computers and storage resources)
- Enterprise stackable switch (performance workgroups and workgroup aggregation)
- AdvancedTCA backplane fabric (star or mesh architecture)
- AdvancedTCA carrier card switch (interconnecting mezzanine cards)
- AdvancedTCA base fabric
- Proprietary system backplane fabric

#### 1.1.2 Features

The following are the general features of the device:

- | Interface Features   | Chip Performance  |
|--|---|
| <ul style="list-style-type: none"><li>• 8 Quad-SerDes Ethernet interfaces (802.3ae), configurable as follows:<ul style="list-style-type: none"><li>• XAUI (10GBase-CX4 compliant)</li><li>• XAUI overspeed up to 12.5Gbps</li></ul></li><li>• 2.5G Ethernet</li><li>• 1G Ethernet (SGMII, 1000BASE-X)</li><li>• 10/100M Ethernet</li></ul> | <ul style="list-style-type: none"><li>• 120 Gbps bandwidth</li><li>• 180M FPS</li><li>• &gt;180M segments per second (segments of 64 bytes)</li><li>• Low-latency cut-through switching: 200 ns @ 10G, 650 ns @ 1G.</li><li>• Store and Forward mode</li></ul>  |
| <ul style="list-style-type: none"><li>• 16 Single-SerDes Ethernet interfaces, configurable as follows:<ul style="list-style-type: none"><li>• 2.5G Ethernet</li><li>• 1G Ethernet (SGMII, 1000B-CX)</li><li>• 10/100M Ethernet</li></ul></li><li>• Link Aggregation (802.3ad)</li></ul>  | <p><b>Switch Element Features</b></p> <ul style="list-style-type: none"><li>• Centrally-buffered, fully provisioned, non-blocking, shared memory switch with ideal transfer characteristics</li><li>• 2x internal fabric overspeed</li><li>• ¾ TB of shared memory bandwidth</li><li>• 600 MHz memory event rate</li><li>• Full speed multicast</li></ul> |





- Multi-point Link-Ag extensions
- PAUSE flow control (802.3x)
- Inter-frame gap stretch (Rate Control)
- Intel® extensions to support complex topologies and large-scale applications

#### Security

- MAC address security
- Port access control (802.1x)

#### Bridge Features

- 16K entry MAC address table
- Spanning Tree (802.1D, s, w)
- VLAN, priority (802.1Q, P)
- 4K VLAN table
- Link Aggregation (802.3ad)
- Duplex Flow Control (802.3x)
- All IEEE protocol traps
- User-defined monitoring and filtering rules
- RMON, and Intel® statisticsChip Performance

#### Test Features

- JTAG and boundary scan support
- Per-interface field loopback and BIST

#### Congestion Management

- Egress scheduling of 4 traffic classes
- Shared and private watermarks
- PWD (Priority Weighted Discard) on 16 priorities
- Priority regeneration

#### Control Features

- 32-bit standard CPU interface
- SPI EEPROM interface
- Standard LED interface

#### Physical

- 1.0W/0.5W (typ) per active 10G/2.5G interface
- Power scales linearly on activity
- 130 nm CMOS process technology
- 897-ball BGA package

### 1.1.3 Ethernet Interface Flexibility

The FM2112 contains 24 interfaces, 8 of which are quad SerDes interfaces and can be independently configured to support one of the following modes:

- 10G Ethernet: XAUI interface, with 10GBase-CX4 compliance (accomplished with four SerDes pairs operating at 3.125 GHz, with 8b/10b encoding)
- 2.5G Ethernet: Pre-standard implementation (accomplished with a single SerDes pair operating at 3.125 GHz, with 8b/10b encoding)
- 1G Ethernet: SGMII and 1000BASE-X compliance (accomplished with a single SerDes pair operating at 1.25 GHz, with 8b/10b encoding)
- User-configurable mode: The FM2112 can support two input reference clocks, each operating up to 400 MHz. Each of the device's 8 quad SerDes interfaces can independently select one of the two reference clocks. Additionally, each interface can be configured to have one or four SerDes pair(s) active. So, as an example, given two input clocks of 312.5 MHz and 400 MHz, each interface can be independently configured to support data rates of , 2.5 Gbps, 3.2 Gbps, 10 Gbps, and 12.8 Gbps.

And 16 of which are single SerDes interfaces and can be independently configured to support one of the following modes:

- 2.5G Ethernet: Pre-standard implementation (accomplished with a single SerDes pair operating at 3.125 GHz, with 8b/10b encoding)
- 1G Ethernet: SGMII and 1000Base-CX compliance (accomplished with a single SerDes pair operating at 1.25 GHz, with 8b/10b encoding)
- User-configurable mode: The FM2112 can support two input interface clocks, each operating up to 4 GHz. Each of the device's 16 interfaces can independently select one of the two reference clocks. Additionally, each interface can be configured to have one or four SerDes pair(s) active. So, as an example, given two input clocks



of 3.125 GHz and 4 GHz, each interface can be independently configured to support data rates of 10 Mbps, 100Mbps, 1 Gbps, or 2.5 Gbps.

When all interfaces are set to the same operating mode, the FM2112 performs as a cut-through switch. When interfaces are configured for different modes, the FM2112 performs a store-and-forward function on the link pairs that don't have matching clock rates to avoid buffer overruns and other congestion due to interface rate mismatch.

#### 1.1.4 Control and Test Interfaces

The FM2112 also contains a standard 32-bit address/data processor bus interface that is used to read and write all Control Status Registers that control the chip configuration and operation, and also to obtain status and to debug the chip. This CPU interface can be configured to support a variety of commercial processors including the Freescale family of PowerPC processors that contain the EBC bus (such as the 8347 and 8541), and various I/O bridge chips (such as the PLX 9030 PCI bridge chip from PLX Technologies). The different modes are supported through pin strapping options. This CPU interface operates up to 100 MHz.

Additionally, the FM2112 contains an LED interface that can be connected to external LED driver chips to provide port- and system-level status and activity via front-panel LEDs.

Lastly, the FM2112 implements an industry-standard JTAG controller for test and design debug. The JTAG controller can access boundary scan registers and all internal registers.

## 1.2 Application Examples

With unprecedented integration, performance, power efficiency, and latency characteristics, the FM2112 can be used for a variety of infrastructure and interconnect applications, some of which include:

- Blade computer and IP storage platform internal fabric
- Data center cluster interconnect (clustered computers and storage resources)
- Enterprise stackable switch (performance workgroups and workgroup aggregation)
- Advanced TCA backplane fabric (star or mesh architecture)
- Advanced TCA carrier card switch (interconnecting mezzanine cards)
- Advanced TCA base fabric
- Proprietary system backplane fabric

The FM2112 is a versatile device that can be used in a variety of applications where efficient Ethernet packet switching is the method of choice for interconnecting the elements in a system. The following subsections detail some of the common applications that the FM2112 is capable of supporting, and identifies some of the device's capabilities that are relevant for each application.



### 1.2.1 Advanced TCA Chassis Base Fabric Switch

The FM2112's high level of integration (high port count) makes it a great fit for the Advanced TCA chassis (including the 14-slot, 19"-rack version and the 16-slot, 23"-rack version, as well as the smaller variants). With 8 10G ports and 16 2.5/1G ports, the device complements the FM2112 on the fabric boards and supports the ATCA-defined dual star base fabric.

In this application, two slots in the chassis are populated with switch fabric cards that provide main fabric and base fabric connections to all other cards in the chassis. The 16 1G Ethernet base interfaces on these hub boards connect to the Shelf Management Controller, the other hub board and the 14 node boards.

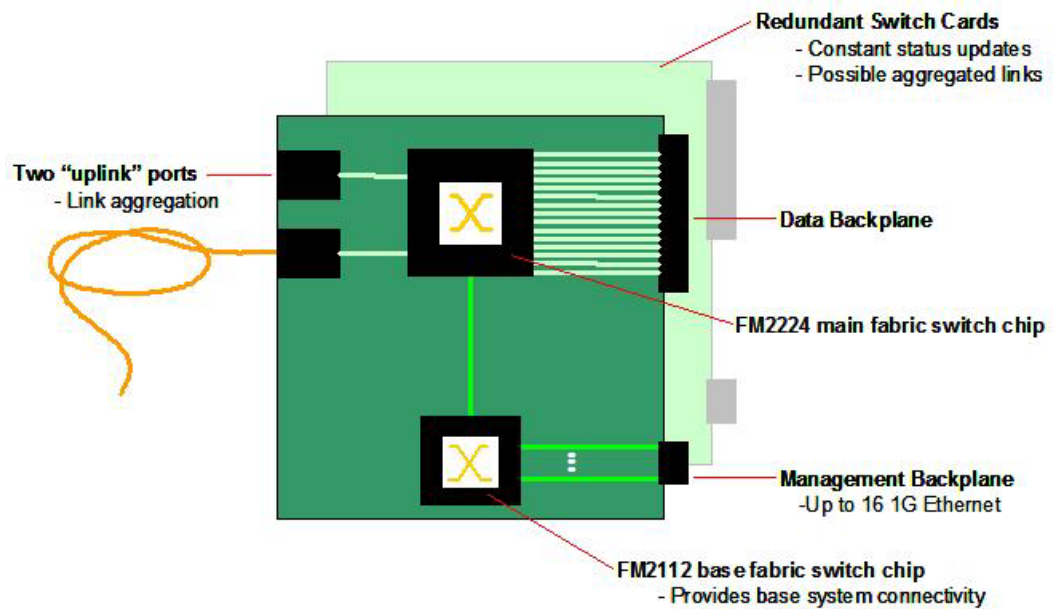

**Figure 1.** Advanced TCA Base Switch Fabric

#### Key Capabilities

- 10G inter-switch links to data fabric switch (optional)
- Up to 16 1G Ethernet ports for connection to the 1G Ethernet base fabric
- Fail-over redundancy from one switch element to the other, using a method of polling status information between the two switch elements, and rapidly switching traffic from one element to the other.

### 1.2.2 Stackable Switch

In this application, the FM2112 serves as the core of a stackable switch implemented in a 1U form factor, providing a low cost point of entry and subsequent scalability. The non-blocking, low latency

characteristics of the FM2112 allow congestion-free, low-latency switching for the high performance data center. Four or more 10G ports can be used for inter-switch links (ISL's) or for high capacity uplinks.

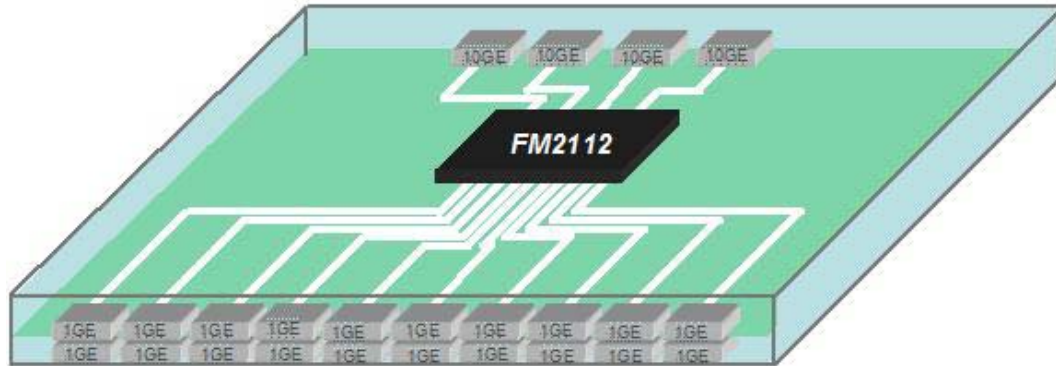
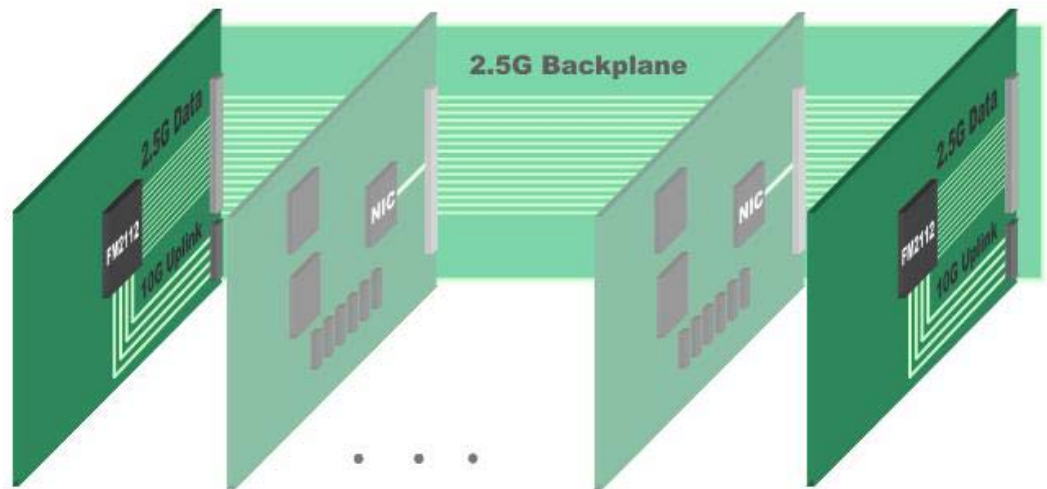

**Figure 2.** Stackable Gigabit Ethernet Switch

### 1.2.3 2.5 Gigabit Backplane Upgrade

Bladed compute systems require low latency, high bandwidth backplane connectivity between server and switch blades. A key feature of bladed systems is a high degree of scalability, most often achieved by out-scaling - increasing computational power via the addition of compute resources. Up-scaling involves increasing the throughput of each component and is generally less attractive because of the requirement for the switches and backplane to operate at higher data rates. The FM2112 facilitates up-scaling of 1Gbps systems by providing switching and SerDes operation at 2.5Gbps over the same backplane traces used for 1Gbps systems. In addition, up to 8 10Gbps ports afford plenty of throughput for uplinks or internal high bandwidth fabric ports.

This example shows a series of bladed servers serviced by a pair of FM2112 switches where 20 1Gbps/2.5Gbps ports are used for interconnect, including ISL's, and 4 10Gbps ports for uplinks. The system can run at 1Gbps across the backplane or 2.5Gbps by changing only the server blades.



**Figure 3.** Bladed Server System with 2.5G Backplane

#### Key Capabilities

- Single SerDes operation at 1Gbps and 2.5Gbps.
- 802.1Q-2004 VLAN.
- 802.1D-2003 Spanning Tree Protocol
- Low latency

### 1.2.4 Applications Summary

Summarizing, with a rich set of features, and unprecedented performance and integration, the FM2112 can be used cost-effectively (and to deliver differentiation) in a variety of Ethernet switching applications in both the communications and computing markets. And, as is the case with Advanced TCA, the FM2112 can provide a platform for accelerating the convergence of the two markets and related applications.

### 1.3 Supported Standards and Specifications

The following standards and specifications are supported by (or otherwise relevant to, as noted) the FM2112:

#### IEEE

- 802.3
  - 802.3-2002
  - 802.3ae
  - 802.3z
  - 802.3ak (CX4)
  - 802.3ad
- 802.1



- 802.1D (2004)
- 802.1Q (2003)
- 802.1p
- 802.1s
- 802.1w
- 802.1X

## 1.4 Definitions

The following are terms that are relevant for the FM2112, and which are used throughout this document to describe the features, functions, configuration, and use of the FM2112.

Interface	Generic term referring to a single logical implementation containing a transmit and receive data path. The FM2112 contains several interface types (XAUI, JTAG, CPU, LED, etc.).
Port	Refer to the definition of "Interface" above. Used interchangeably with "interface", although used more frequently to identify a specific physical implementation - rather than a generic logical implementation. As examples of how both are used: "The FM2112 contains 24 10G Ethernet interfaces"; "Make sure the port is enabled before sending data".
XAUI	Ten-Gigabit Attachment Unit Interface, defined by the IEEE as an interface extender for XGMII (the ten-Gigabit Media Independent Interface).
CX4	Used generically in this document to refer to the ten-Gigabit copper interface extensions made to XAUI (and defined by IEEE as 10GBase-CX4) to support copper "CX4" cables. The interface is intended to connect servers or switches over short distances - up to 15 meters.
CSR (Register)	Control Status Register used for configuration, status reporting, and debug.
Nexus	Intel's Terabit fully-connected non-blocking crossbar; Nexus is used to make the Terabit non-blocking shared memory switch element.
Queue	Conceptually, a temporary packet storage element in the shared memory (a.k.a., FIFO). In the FM2112, each frame has multiple queue associations in the memory, and those associations are used for congestion management and scheduling.
Cut Through	A switching mode or architecture where the switch can begin transmitting the packet as soon as the destination port is known, without waiting for the end of the frame to arrive.
Store-and-Forward	A switching mode or architecture where the packet is first copied to memory (stored) in its entirety before being delivered (forwarded) to the destination port. This mode is typically used to forward between ports of different speeds or to ensure frames with bad CRC are discarded immediately.



## 2.0 Architectural Overview

### 2.1 Principles of Operation

The FM2112 is an IEEE-compliant Ethernet bridge. For an in-depth discussion of the principles of operation, see Clause 7 of the IEEE 802.1D-2004 specification.

### 2.2 Architectural Partitioning

The Intel® Ethernet Switch Family is architecturally partitioned into five major blocks, as shown in Figure 4. They are:

- Ethernet Port Logic (EPL), RX and TX.
- Frame Processor (FP)
- Switch Element Data Path (SEDP)
- Switch Element Scheduler (SES)
- Management (MGMT)

This partitioning was designed specifically to attain high throughput, high port density, low latency, and low power in a single integrated device.

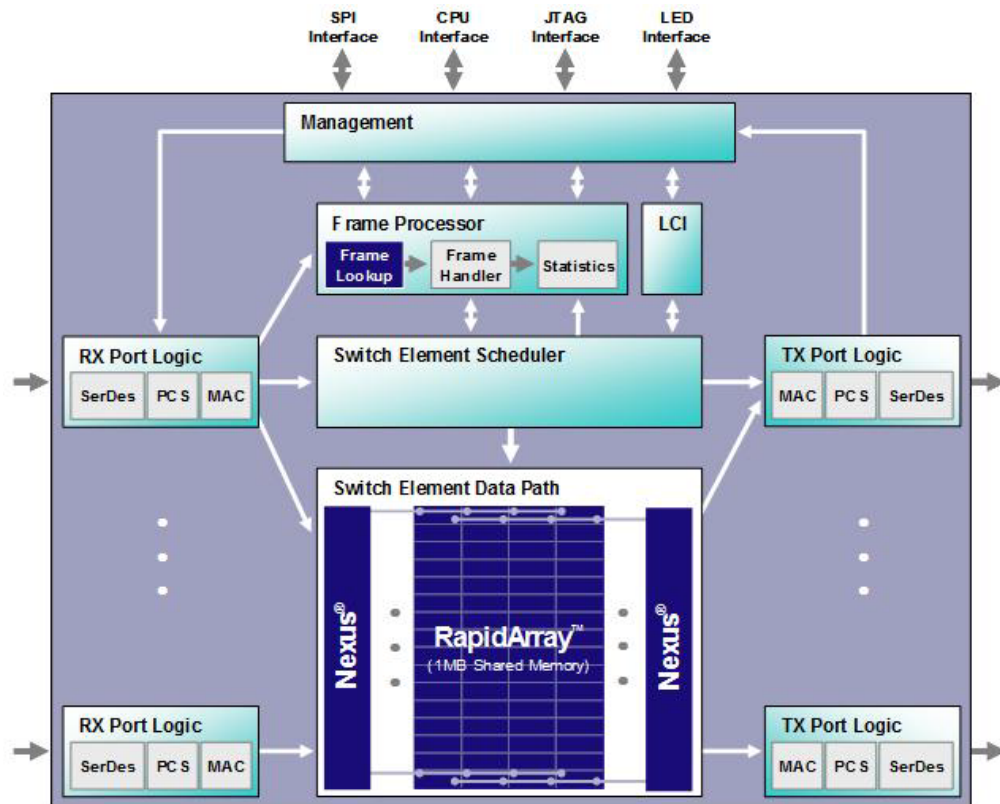

Figure 4. FM2112 Block Diagram



## Ethernet Port Logic (EPL)

The Ethernet Port Logic (EPL) is the per-port replicated block. It is purposely designed to be as “thin” as possible to enable the FM2112 to scale -- practically -- to 24 ports. The EPL contains only the essential features to identify a packet and its header, parse the information appropriately, and stream the information to the correct location. The EPL implements the PMA and PCS layers, and it further checks each frame for various errors, including length and frame errors. The packet data is buffered into a 64-byte segment for streaming into the switch element at the Nexus data rate (30 Gb/s per port), beyond which the EPL is purely cut-through. The header is parsed and sent to the frame processor. On TX, the EPL collects tag information from the scheduler and uses that to perform VLAN egress tagging.

## Frame Processor (FP)

The Frame Processor (FP) is a centralized and highly-optimized pipeline that implements all of the complex frame relay policy and congestion management functions, and keeps statistics for activity across the entire chip. Once a reservation has been set, the frame processor pipeline is deterministic, producing one header per clock, and no further queuing is required. It takes a header as its input and produces a forwarding mask 6 clocks later - at full line rate for up to 24 ports. It processes the destination MAC address, source MAC address, VLAN, and Spanning Tree protocol. In addition, it checks security and reserved traps, and updates the MAC Address table. It receives queue status from the switch element scheduler and determines whether to discard frames or pause inputs on a frame's ingress. And finally it manages the link aggregation groups.

## Switch Element Data Path (SEDP)

The switch element is a fully-provisioned, centrally-buffered switch with ideal transfer characteristics. It consists of the switch element datapath and scheduler.

The Switch Element Data Path (SEDP) is a shared memory structure constructed from Intel's proprietary crossbar and memory technology. The memory delivers approximately three-quarters Tb/s of bandwidth, necessary to support sustained transfer of the worst segment corner case of 65-byte frames. Though it uses crossbars it is not a “crossbar-based” switch; it is centrally buffered. On ingress, frames are streamed in from the 24 EPLs through a crossbar, in a non-blocking fashion, to 16 banks of 64 kB of memory (1 MB total), where they are kept while the headers are queued and scheduled. Each 64-byte segment from the EPL is striped across the 16 32-bit banks of memory (512 bits at a time). Another crossbar then connects the 16 banks of memory back





out again to the 24 ports on egress, permitting a non-blocking transmission of scheduled frames, with no multicast replication bottlenecks.

### **Switch Element Scheduler (SES)**

The Switch Element Scheduler (SES) manages the frame data in the switch element datapath and communicates with the frame processor and switch element datapath. It performs a time-sliced arbitration algorithm to schedule frames streaming across the ingress crossbar. It then represents the frame as a linked list of pointers that may exist anywhere in the memory, allocating pointers on ingress, and freeing pointers on transmission. (A pointer points to a group of four segments, allowing a maximum of 4096 packets in the switch at one time.) The SES queues out-of-band frame information that travels along with the packet and comes from the frame processor, and it queues the segment pointers. It manages multicast replication, as pointers are forwarded from an RX queue to a TX queue. Frames marked with errors, from either the EPL or the FP, are discarded if the frame has not yet been transmitted. If the frame has been partially transmitted, then it is forced to have a bad CRC. The frames are scheduled for egress transmission according to a number of selectable algorithms, including strict priority and weighted round robin. Frames are associated with three queues: RX port, TX port, and shared memory. The queue status is reported to the frame processor for its use in congestion management decisions for pause and discard.

### **Management (MGMT)**

The Management block (MGMT) contains slow interfaces to access and configure the device. It allows the FM2112 to communicate with a host. There is an internal management bus that matches the slow rate of the management interface to all of the different high-speed blocks in the device. The management block cannot get involved with the actual line rate forwarding activity, but it otherwise has a high degree of visibility into the device.



## 3.0 Functional Description

This section describes in detail the features and functions supported by the FM2112.

### 3.1 Ethernet Port Logic (EPL)

The FM2112 contains 24 Ethernet Port Logic transmit and receive pairs; each pair contains the SerDes, PCS, and a portion of the MAC functionality.

#### 3.1.1 Port and Lane Configuration

{Registers described in [Table 133](#).}

The 8 10G interfaces can be independently configured to have one or four lanes active (quad SerDes), while the 16 2.5G interfaces always have only one lane active (single SerDes).

With this combination of configuration parameters, the FM2112 can be configured to support a mixture of 1G, 2.5G, and 10G Ethernet ports within the constraint of 8 interfaces that support up to 10G in quad-SerDes mode and 16 interfaces that support up to 2.5G in single-SerDes mode, as well as any other 1-lane or 4-lane rate, within the supported frequency range of the EPL interface.

For convenience of the board layout, lane reversal is supported, which means that for each quad-SerDes port "Lane 0" to "Lane 3" is either interpreted as an increasing order or a decreasing order. So that 1G and 10G modes can be soft selectable on the same interface, the lane reversal also affects whether "Lane 0" or "Lane 3" is used as the single active SerDes to support 2.5G and 1G modes.

[Figure 5](#) shows an example of an interface configured with one lane active, connected to the first high-speed clock source.

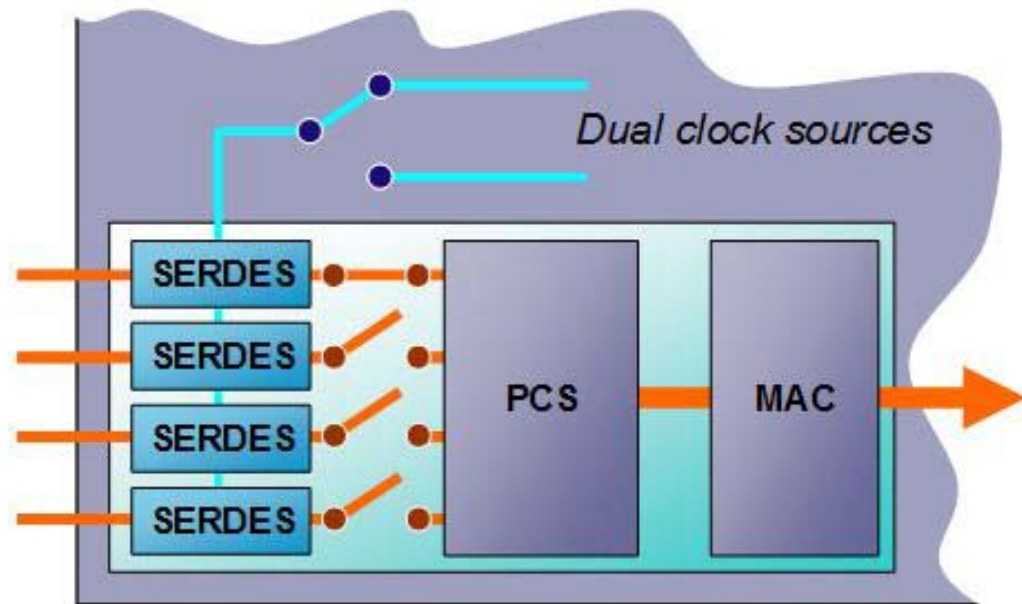

Figure 5. Ethernet Port Logic Functional Blocks

### 3.1.2 SerDes

{Registers described in Table 130 through Table 144.}

Eight of the twenty four ports (port numbers 1 - 8) contain a block of four SerDes and the remaining sixteen ports (port numbers 9 - 24) contain only a single SerDes. Four pairs of independent high-speed clock sources, each of which can operate at any rate from 100 MHz to 400 MHz, may independently service four groups of interfaces, as shown in Table 1. Each of the 24 ports can independently select from among the two clock inputs routed to it by setting the corresponding bit in the PORT\_CLK\_SEL register (Table 46). Since both the serializer and deserializer in a SerDes utilize the same clock, the Tx and Rx sections of an interface cannot operate at different frequencies.

Table 1. Reference Clock to Port Correspondence

RCK1AP/N	Ports 1, 3, 5, 7, 9, 11
RCK1BP/N	
RCK2AP/N	Ports 2, 4, 6, 8, 10, 12
RCK2BP/N	
RCK3AP/N	Ports 13, 15, 17, 19, 21, 23
RCK3BP/N	
RCK4AP/N	Ports 14, 16, 18, 20, 22, 24
RCK4BP/N	



The per-lane data-rate on the “8b” side is a factor of 8 greater, yielding 800 Mb/s to 3.2 Gb/s of actual data throughput, and on the “10b” side this gives 1 Gb/s to 4 Gb/s of serial data per lane.

### 3.1.2.1 Compatibility

The SerDes interface is electrically compatible with the following standards and specifications:

- 1G Ethernet
  - IEEE 802.3ad, 1000BASE-CX
  - SGMII
- 10G Ethernet
  - IEEE 802.3ae, XGXS (XAUI)
  - IEEE 802.3ak, 10GBASE-CX4
- Ethernet at a user-configured rate
  - As an example, 2.5G Ethernet through the use of a single SerDes pair

### 3.1.2.2 Phase-Locked Loop (PLL) and Reference Frequency

The electrical specifications for the clock are described in Section 3.6.1.

Using a divide-by-5 ratio, the PLL has a frequency of operation from 500 MHz to 2 GHz. The data is double pumped off of the voltage-controlled oscillator. The PLL does not need to support 1G operation from the same clock source that supports 10G operation as that feature is achieved through the use of the second off-chip reference clock.

### 3.1.2.3 Transmitter Drive Current

The nominal SerDes output driver current is set to 20 mA by an external resistor of 1.2KΩ tied between the Reference resistor pad. Connect a 1.2KΩ resistor from each RREF pad to 1.2V VDDX or a 1.0KΩ resistor from each RREF to 1.0V VDDX. Provides a reference current for the driver and equalization circuits. pins (1 per port) and VDDX. A new nominal output current value of 10 mA or 28 mA may be set individually for each lane in each port by setting the corresponding High Drive and Low Drive bits in the SERDES\_CNTL\_2 register (see [Table 133](#) for details).

The output currents may be further modified from this nominal value for each of the 4 lanes in each port by setting the corresponding DTX bits in the SERDES\_CNTL\_1 register (see [Table 130](#) for details). Using these bits the current can be set from 60% to 135% of the established nominal value.



### 3.1.2.4 Transmitter Equalization (Pre-emphasis)

Each transmitter has a first-order equalization function implemented as a pre-emphasis current (sometimes termed, “de-emphasis” because the lower frequency components of the signal are reduced, or de-emphasized). Equalization helps reduce the amount of inter-symbol interference by counteracting the effects of frequency dependent transmission loss. The effects of pre-emphasis are shown in The FM2112 SerDes uses a fixed, optimized amount of Rx equalization to complement the pre-emphasis function.

By setting the DEQ bits in the SERDES\_CNTL\_1 Register (see [Table 130](#)), the ratio of equalization current to driver current varies from 0.0 (equalization off) to a maximum of 0.65. With a setting of 0.65, for example, driver current is reduced from the nominal value (set with High Drive, Low Drive and DTX bits) by 65% for those bits where equalization is in effect. Equalization is in effect when successive 1's or 0's are sent. The first bit after a transition is not affected, but the second and all subsequent consecutive bits are affected by the drive current reduction until another transition occurs.

The overall effect of this pre-emphasis function is that of a high-pass filter, which can be used to compensate for the low-pass characteristic of transmission media. The FM2112 SerDes uses a fixed, optimized amount of Rx equalization to complement the pre-emphasis function.

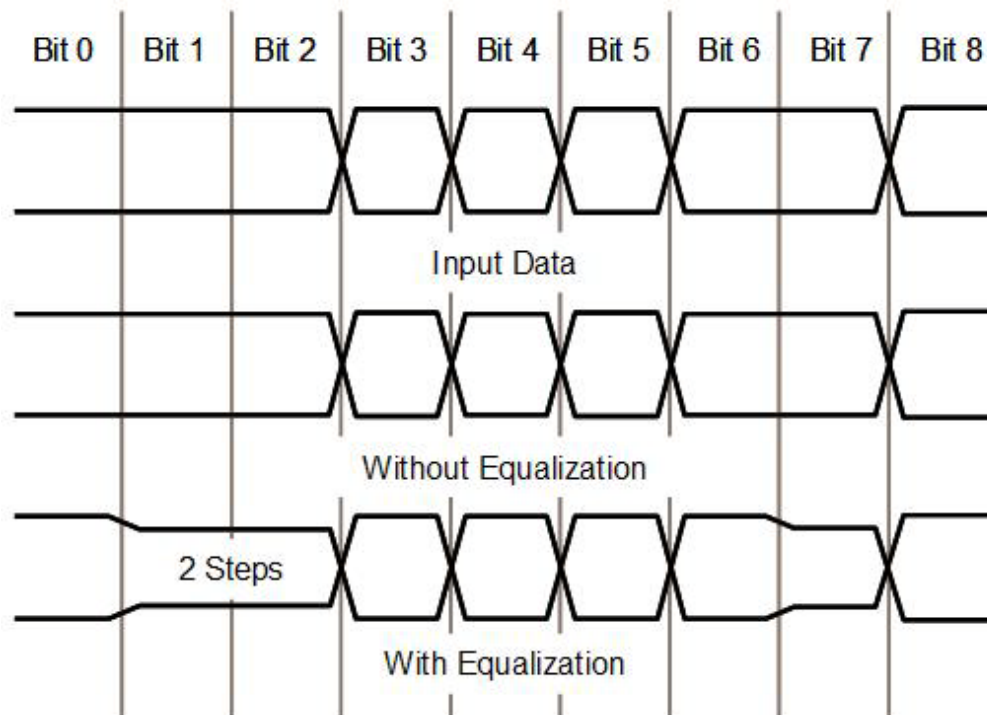

Figure 6. Driver Equalization



### 3.1.2.5 Transmitter Output Voltage

The drivers are terminated in a 25 Ω load, obtained by two 50 Ω in parallel. The single-ended voltage swing, VSW, is determined multiplying the driver current, IDR, by this impedance.

### 3.1.2.6 Driver Termination Voltage

The driver termination voltage is set by the VTT pin. The common mode voltage of the transmitter, VTCM, then results from the termination voltage and the single-ended voltage swing as:

$$V_{TCM} = V_{IT} - V_{SW}$$

The Output High and Output Low voltages are also determined by VTT and VSW:

$$V_{OH} = V_{IT} - 0.5 * V_{SW}$$

$$V_{OL} = V_{IT} - 0.5 * V_{SW}$$

There is a limit placed on VSW by the VTT setting. The limits on VSW for various settings of VTT are given in Table 2. VSW should be controlled by setting the High Drive and Low Drive bits of the SERDES\_CNTL\_2 register and the DTX bits of the SERDES\_CNTL\_1 register.

Table 2. VTT and Max Allowable VSW

VTT (V)	Max VSW (AC, mV)
1.0	250
1.2	350
1.5	500
1.8	750

### 3.1.2.7 Receiver Clock and Data Recovery

Clock and Data recovery (CDR) at the receiver of the FM2112 is dependent on two factors. One is the ppm difference in the clock frequencies between the transmitting device and the FM2112's receiver. The other is the bit transition density in the data stream.

The lock time of the CDR circuit is dependent on the ppm difference in clock frequencies and the transition density. Given a 1 in 10 transition density (XAUI signals meet this criterion), the CDR lock times are given in Table 3 for several ppm differences.

Table 3. CDR Lock Times

Clock PPM Difference	CDR Lock Time (Bit Periods)
0	640

**Table 3. CDR Lock Times (Continued)**

± 25	684
± 50	734
± 100	860

### 3.1.2.8 Receiver Common Mode Voltage

Receiver common mode voltage is fixed internally and set to 0.7V.

### 3.1.2.9 Receiver Signal Threshold

A signal detect circuit in each port indicates when the received signal strength at any one of its four inputs (for quad SerDes ports) or at its only input (for single SerDes ports) falls below the VLOS level indicated in [Table 26](#). When this occurs, the Signal Detect bit in the SERDES\_STATUS register ([Table 138](#)) is asserted. The Signal Detect bit is not de-asserted until a configurable number of above-threshold signal cycles is reached ([Table 136](#)).

### 3.1.2.10 Loopback

A per-port Tx-to-Rx loopback mode is provided that, for each SerDes, loops back data from the output of the serializer to the input of its deserializer/clock recovery circuitry (see [Table 137](#)).

Note that although signal detect is actually achieved, Signal Detect in the SERDES\_STATUS register ([Table 138](#)) is not raised. Frames received in loopback mode are considered as RxSymbolErrors (Group 1 Counters), but this may be ignored by setting the PHY Error Discard bit in MAC\_CFG\_2 ([Table 156](#)).

### 3.1.2.11 Lane Reversal

XAUI lane reversal is supported (See [Table 145](#) PCS\_CFG\_1[RI and TI]) on all ports. IEEE 802.3 specifies XAUI lanes as 0:3 and they are also referred to in this way in this datasheet when referring to them at the PCS layer or higher. Since lane ordering can be reversed at the serdes inputs/outputs, lanes are referred to as A:D at the serdes I/O.

Without setting lane reversal bits, the correspondence between these two designations is 0:3 corresponds to A:D and when lane reversal bits are set, the correspondence is 0:3 to D:A.

## 3.1.3 SerDes - Testing with BIST

{Register described in [Table 137](#), [Table 143](#) and [Table 144](#).}

The FM2112 supports field operation of the BIST (Built-In Self Test).



Each SerDes lane has one (BIST) transmitter and one BIST checker. The supported BIST modes are:

- 0 - Disable
- 1 - PRBS (x9+x5+x1), repeat every 511 cycles
- 2 - High frequency test data = 1010101010
- 3 - Test data = K28.5 (IDLE)
- 4 - Low frequency test data = 0001111100
- 5 - PRBS (x10+x3+x1), repeat every 1023 cycles
- 6 - PRBS (x9+x4+x1), repeat every 511 cycles
- 7 - PRBS (x7+x1), repeat every 127 cycles

The BIST transmitters on all 4 lanes are automatically enabled when the BIST mode is set to a value different than 0. The BIST checkers are activated by writing a 0 into SERDES\_TEST\_MODE[BS]. The values in BIST\_ERR\_CNT count the number of errors received per lane.

The BIST checker will work properly only if symbols are aligned prior to start the checker. The symbol alignment is done by the PCS framer using the comma character as a reference which is the only character to use a series of five 1s or 0s in the normal flow of data. However, as the BIST transmitter may generate this test pattern, it is important to follow the following procedure:

- Obtain symbol lock prior to enabling BIST transmitter (bits 3-0 of SERDES\_STATUS)
- Disable PCS framer (bit 6 of SERDES\_TEST\_MODE)
- Set BIST mode (which automatically enabled the transmitter as well)
- Enable BIST checker (bit 5 of SERDES\_TEST\_MODE)
- Verify BIST\_ERR\_CNT to detect any error

### 3.1.4 PCS

{Registers described in [Table 145](#) through [Table 151](#).}

The PCS is fully compliant to the following specifications:

- IEEE 802.3ae Clause 48 (10GBase-X) specification for XAUI mode
- IEEE 802.3-2002 Clause 36 (1000Base-X) specification for SGMII mode

#### 3.1.4.1 PCS - Frame Format

The frame format in 10G mode is show in the next table. The value of Dp (Data preamble) is 55h (symbol D21.2), the value of Ds (Data start) is D5h (symbol D21.6). The PCS layer always expect a strict 8-symbol preamble (includes 1x|S|, 6x|Dp| and 1x|Ds|).





LANE 0	S	Dp	D	D	...	D	A	R	K	R	R
LANE 1	Dp	Dp	D	D	...	T	A	R	K	R	R
LANE 2	Dp	Dp	D	D	...	K	A	R	K	R	R
LANE 3	Dp	Ds	D	D	...	K	A	R	K	R	R

The frame format in 1G mode is shown in the next table. The PCS layer is programmable (bit SP of PCS\_CFG) to either expect a strict 8-byte preamble (bit SP is set to 0) or a variable size preamble (bit SP is set to 1). When configured for supporting a variable size preamble, the PCS will accept as a valid preamble any starting sequence of  $1x|S|$ ,  $[0..6]x|Dp|$ ,  $1x|Ds|$ ).

LANE 0	S	Dp	Dp	...	Dp	Ds	D	D	D	...	D	T	R	I	...
--------	---	----	----	-----	----	----	---	---	---	-----	---	---	---	---	-----

In the SGMII 100Mbps mode, the PCS will search for  $|S|$  and then sample incoming data every 10 cycle. In the 10M, the PCS will sample incoming data every 100 cycle.

Finally, the PCS supports 4-bit miss-alignment in the data part of the frame ( $|DP|$  to last  $|D|$ ). This is enabled using the ND option of PCS\_CFG. When this option is enabled, the PCS will accept  $0xD5$  or  $0x5?-0x?D$  as a valid start of frame and will automatically realign the frame before sending it to the MAC layer. This is particularly useful when the SGMII interface is coming from a device that did an MII-SGMII conversion and the size of the pre-amble on the MII was not a multiple of 8 bits. This should only be useful in 10M/100M.

In addition to the requirements in these specifications, some optional enhancements are described as followed.

#### 3.1.4.2 Local and Remote Faults

The PCS performs the following functions:

- Upon reception of at least four local fault symbols (LFS) within a 128-cycle period, the PCS enters into a local fault detect state, and exits it when 128 cycles occur without receiving any LFS. While in local fault, the transmitter sends remote fault symbols (RFS) to the link partner. MAC data is discarded.
- Upon reception of at least 4 RFS within a 128-cycle period, the PCS enters into a remote fault detect state, and exits after 128 cycles without receiving any RFS. While in remote fault, the transmitter sends idle symbols to the link partner. MAC data is discarded.
- The PCS layer can be configured to transmit RFS when the link goes down regardless of whether LFS are received.

In the unlikely situation where two faults are received, then the local faults shall take precedence.

A cycle is 4 bytes.



### 3.1.4.3 PCS - Messaging

The PCS supports simple in-band messaging; it is capable of transmitting or receiving up to 24 bits of information.

Upon receiving an FSIG symbol, the PCS registers the lower 24 bits and indicates that an FSIG symbol has been detected, with interrupt generation.

The PCS can transmit an FSIG message. The lower 24 bits are registered and the PCS is forced to transmit the FSIG symbol, with interrupt generation.

### 3.1.4.4 PCS - Balancing the Inter-Frame Gap (IFG)

From the requirement Clause 48 (that frame transmission begins on Lane 0) there is an option of two separate implementations, both supported in the FM2112, as follows:

- Guarantee minimum IFG: The MAC always inserts additional idle characters to align the start of preamble on a four byte boundary. Note that this will reduce the effective data rate for certain packet sizes separated with minimum inter-frame spacing.
- Maintain an average minimum IFG: The MAC sometimes inserts and sometimes deletes idle characters to align the Start control character. A Deficit Idle Count (DIC) represents the cumulative count of idle characters deleted or inserted, and this count is bound to a minimum value of zero and maximum value of three. Note that this may result in inter-frame spacing observed on the transmit XGMII that is up to three octets shorter than the minimum transmitted inter-frame spacing specified in Clause 46.

### 3.1.5 IFG Stretch (IFGS)

{Registers Described in [Table 152](#), [Table 153](#), and [Table 154](#)}

*Note:*

At the link level, frames can no longer be re-ordered. So if the scheduler picks a frame to transmit that can't go because of the IFGS and the frame priority, it is not acceptable for a higher priority frame behind it to be transmitted first even if it meets the watermark check in `EPL_PACE_PRI_WM[i]`.

The index used [0..7] is retrieved from the switch priority to egress priority table `TXPRI_MAP` regardless if the priority regeneration is enabled or not.

Inter-Frame Gap Stretch is a feature that affects the amount of idle characters between packets for the purpose of congestion management. Therefore it should be thought of as being above the XGMII. Since it is independent of MAC functionality, it is described in its own section, as follows:

This feature is not an IEEE compliant feature. However it is a pre-standard implementation of a feature set currently being defined within the IEEE 802.3ar congestion management task force.



### 3.1.5.1 Theory

It is often desirable to limit the rate that a device can send data to its link partner to a defined rate that is below the maximum rate of the link (often referred to as rate pacing). In some situations the link partner is not capable of consuming data at the maximum rate, sustained. By limiting the rate (rate pacing), one can avoid overloading the receiving device. Given that the IEEE 802.3ae specification defines a link rate of 10 Gbps, rate pacing is achieved by sending a frame at line rate, and then stretching the inter-frame gap to some extent to achieve the desired average data rate on the link over a specified period of time, allowing a 10 Gigabit link to maintain an effective rate which is lower than the clock rate.

### 3.1.5.2 Definition of Terms

PR	Pacing Rate: The target bandwidth of the link.
IFGS	Inter-Frame Gap Stretch: The calculated length of byte times that the transmitter places after a frame before the start of the next frame in addition to the standard preamble and IFG to achieve the pacing rate.
Length	Length of the previous frame.
IFGC	Inter-Frame Gap Constant. The traditional IFG, or the IFG when the pacing rate = line rate. $IFG = IFGS + IFGB$ .
Eligible	The port is eligible if it has a frame in memory that the bridge indicates is ready for transmission.

### 3.1.5.3 Functionality

#### Datapath

The transmitter calculates the IFGS for the next frame via the equation:

$$IFGS[n+1] += (1/PR-1)*Length+IFGS[n]$$

$$\text{Next Packet} \geq \text{EOP} + \text{Preamble} + \text{IFGC (strict requirement)}$$

$$\text{Next Packet} \geq \text{EOP} + \text{IFGS (soft requirement)}$$

After a frame is transmitted, the transmitter does not begin transmitting the next frame, even if the port is eligible, until it has waited for the time it would take to transmit the IFGS worth of bytes.

#### Control

The pacing rate is statically controlled. (It is anticipated that the IEEE will define a standard method for dynamically controlling this feature by exchanging control messages with the downstream link partner.



However, this capability has not been defined, and is beyond the scope of the feature in this generation of the Intel® Ethernet Switch Family architecture.)

### Priority Pacing

10G improves latency over 1G because it takes 1/10 the time to transmit a frame. So even if a server doesn't need 10G, it may be desirable to have a 10G connection for low latency. Pacing is used to control the bandwidth to a level that the server can consume. There is a catch though: if a high priority frame follows a low priority frame, then it experiences a delay equal to the length of the low priority frame plus the IFG stretch. In the case of sustained low priority bandwidth, the high priority frame will always find itself behind a low priority frame, and will always get stuck behind the IFGS, which could completely nullify the latency advantage of going to the 10G link.

To mitigate this adverse effect, the link can be configured to run ahead of the pacing rate by a finite amount. This is unavoidable during the transmission of a packet, which must proceed at 10 Gbps. A packet should not be dropped by the downstream link partner provided that over the time interval  $T$ ,  $BW \leq PR * T + C$ , where  $C$  is a constant that represents a reserved amount of space in the downstream link partner's frame buffer. As a latency optimization, priority is taken into account in determining when to repay the accumulated IFGS.

### Counter Implementation

The IFGS is implemented with a counter, which operates with the following rules:

- Every time a frame is transmitted the length of the frame is added to the counter.
- Over time-interval  $T$ ,  $10 \text{ Gbps} * PR * T$  is subtracted from the counter.
- The value of  $T$  is 1024 bytes. This will cause a jitter of +/- 800ns. The maximum pacing rate is 1/256th of the line rate. The precision is 0.4% of a 10 Gbps link.
- The counter may not go below zero. The counter may go as high as the max WM + Max frame size.

There are watermarks per priority. On transmission of a new frame, the counter is checked against the watermark for that frame's IEEE 802.1p priority. If the counter is below the watermark, the frame is transmitted, if the counter is above the watermark, the frame is not transmitted. After the counter is decremented, the watermark is checked again. This check is independent of the minimum inter-frame gap check that all packets must meet.

#### 3.1.6 MAC

{Described in registers [Table 155](#) and [Table 156](#)}



The FM2112 implements a standard 10 Gigabit Ethernet MAC and/or a standard 1G full duplex MAC (SGMII), and in addition supports some optional proprietary and/or pre-standard implementations. The supported specifications are:

- IEEE 802.3ae (10G MAC)
- IEEE 802.3z (SGMII MAC)

The MAC layer performs:

- Frame length enforcement
- CRC checking on ingress and CRC checking and generation on Egress
- Frame padding
- MIB counters (described in the frame control section)
- VLAN tagging (described in VLAN section)
- Priority regeneration (described in congestion management)
- MAC control frame trapping and generation
- Special support for proprietary routing applications

### 3.1.6.1 Frame Length, Errors and Trapping

The MAC supports the following frame lengths, and has specific counters for their bins:

- Standard Ethernet frames - 64 bytes to 1522 bytes
- Jumbo frames - up to 10240 bytes
- Small frames - A minimum frame size configuration that can be set as low as 32 bytes. However, the system must not go above the max frame rate of the FM2112.

The CRC of all incoming frames is checked. In addition on Egress, after queuing and before any tagging, the CRC is checked again, to catch soft errors. Finally, the CRC may be regenerated on Tx if a tag is added or removed. In the event of an error in cut-through mode, the CRC may be forced bad.

Padding:

- If the actual frame length is below specified minimum frame length, and the frame is not discarded, it is padded to the minimum frame length before transmission.
- If a length of a legal frame is reduced below the minimum frame length because a VLAN tag was stripped, then it is padded to the minimum frame length.

### 3.1.6.2 Flow Control

{Described in registers [Table 157](#) through [Table 159](#)}

The FM2112 is fully compliant with the "Pause" specification of IEEE 802.3-2002 Clause 31 and Annex 31B, also published as IEEE 802.3x.

At the link level the following aspects of "Pause" are configurable:

- Whether the pause feature is on



- If the pause feature is off, whether the switch should discard or trap MAC control frames to the CPU
- Number of 512 bit times specified in the Tx Pause message
- Time between Pause messages sent by the Tx to the upstream link partner, when the port is “paused” by the congestion management watermarks.
- The port MAC address which is the source address in a Pause message.

The policy for when a port is paused is described in 3.3.

### 3.1.6.3 Proprietary Header Support

{Described in registers [Table 72](#) and [Table 155](#)}

This is not an IEEE compliant feature, but is generally considered useful for interconnecting XAUI-based ASICs which are not fully IEEE compliant.

The feature is illustrated in [Figure 7](#). It has two components. There is a header offset, which allows the MAC to skip up to 255 bytes (in 4-word increments) before interpreting the next 16 bytes as the actual switching header. Secondly, there is a 128 bit mask that covers any aspect of the header that the switch should ignore (it sets the masked bits to zero internally). Finally, any standard Ethernet feature that is undesired must be turned off.

This enables:

- Pre-pended header information (which the switch can ignore)
- Switching and link aggregation hashing from any field in the header



### Standard Ethernet header

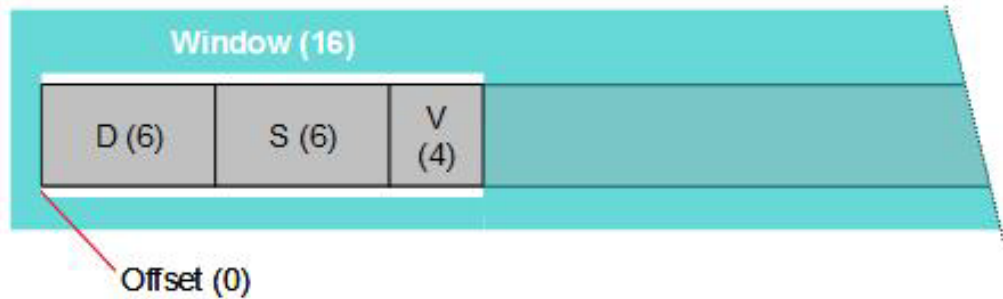

### Proprietary header in front of Ethernet header

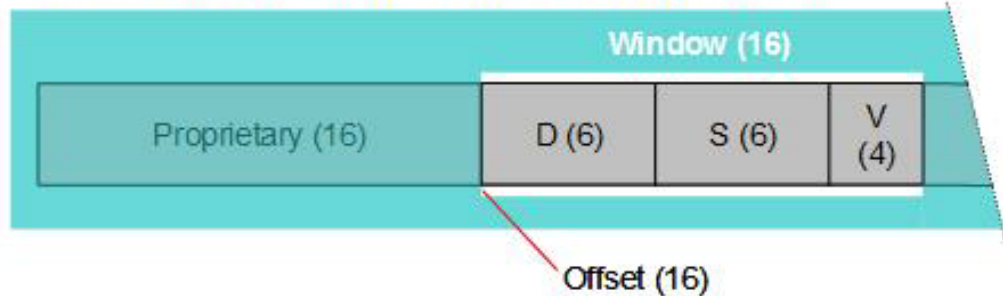

### Switching based on proprietary header

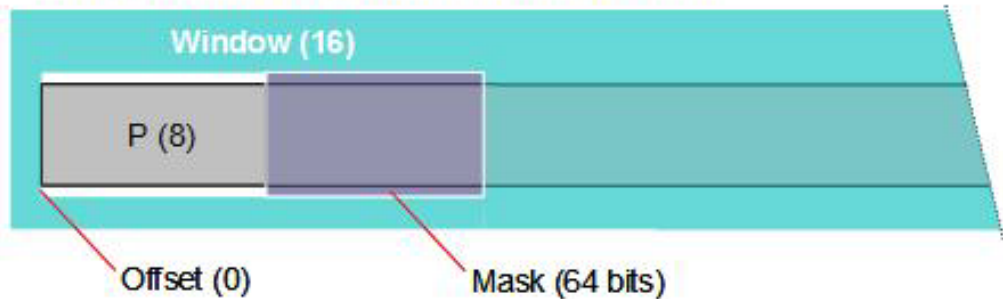

Figure 7. Proprietary Header Support

## 3.2 Frame Control

### 3.2.1 MAC Address Security

{Described in Registers [Table 64](#) and [Table 70](#)}

This is a common ad-hoc feature, not an IEEE compliant feature, which may be used conjunction with IEEE 802.1x

There are two MAC address security checks:



- The Source MAC address in the table
- A Source MAC address in the table is on the correct port

Unknown MAC addresses or known MAC addresses on the wrong port are considered violations when the security feature is enabled. When a frame meets the criteria to be considered a security violation the following actions are possible:

- Security checking is off
  - The frame is forwarded normally
  - No security violations are counted
  - No interrupts are raised
- Security is on
  - The frame is discarded
  - The frame is counted as a security violation
  - A maskable interrupt is raised
  - The frame may be trapped to the CPU

### 3.2.2 IEEE 802.1x - Port Access Control

The FM2112 is fully compliant with IEEE 802.1x, "Port Access Control."

#### 3.2.2.1 Supported Modes

- Single host mode: Software enables MAC security, turns aging/learning off, and statically enters the authenticated supplicant MAC address into the table. Software responds to a security violation.
- Multi-host mode: Software does not enable MAC security, and then any number of MAC address may be learned on the authorized port.
- VLAN Security (guest VLANs): The authentication state of the port in SW is de-authorized, but the physical port is put into the forwarding state, and given a default VLAN. All packets are tagged with this VLAN, all packets that were tagged upstream are discarded. EAPOL messages are trapped. Once the authentication server authorizes the port, it assigns the port a different default VLAN with greater resource access.

### 3.2.3 VLAN

{Described in registers [Table 65](#), [Table 70](#), and [Table 71](#)}

#### 3.2.3.1 Tag-based VLANs

The FM2112 is fully compliant with the IEEE 802.1Q-2004 revision of the VLAN specification. In addition, it supports the following,

- Each port has a default VLAN ID and default priority
- Per port VLAN association and tagging, ingress rule is one of the following:
  - Untagged packets received on a port will be associated with the default VLAN ID and priority configured for that port.
  - For tagged packets, each port may be configured in the following modes:





- The VLAN ID and VLAN priority defined in the packet are used as is
- The VLAN ID and VLAN priority defined in the packet are overwritten with the default VLAN ID and default priority of the port on which the packet is received
- The VLAN ID and VLAN priority is ignored and the packet is considered untagged. The method 3 is useful for support of Q-in-Q (or double tagging).
- Per port VLAN ingress policy, which can be set to any of the following:
  - Discard all untagged packets
  - Discard all tagged packets
  - Discard ingress boundary violation - if the ingress port was not part of the member list of that VLAN ID
  - Discard egress boundary violation - if the egress port was not part of the member list of that VLAN ID for a statically configured address. (boundary violations are counted when none of the egress ports that survive the flood mask are members of the VLAN).
  - The FM2112 supports all 4096 VLANs in a central table that includes the following fields:

*Note:* VLANs are numbered 0-4095, and VLAN# 4095 is reserved.

- Membership list: If the destination is not part of the VLAN it will not be forwarded to that port.
- Egress tag/untagged: If this bit is set, the frame will always leave with the VLAN tag of the associated VLAN.
- Spanning tree state
  - Per VLAN per port spanning tree state enables independent VLAN learning (IVL Bridge).
  - VLAN counters
  - Up to 32 VLANs may be configured for statistics.
- Parity

### 3.2.3.2 Port-based VLAN

Port-based VLANs are an ad-hoc pre-standard implementation of VLANs which can be used instead of or in addition to the IEEE 802.1Q-2004 VLAN tagging. In particular, port-based VLANs provided Mesh architecture support.

In Port-based VLANs, the ports of the switch are separated into groups. Each group is a Virtual LAN.

The following properties apply:

- A port may be a member of any and all other member lists
  - The port configuration must be symmetric. If port A is configured to talk to port B, port B should be configured to talk to A
  - A port has only one VLAN and all frames that ingress that port are associated with it. This VLAN association is implicit; there is no tagging, and the VLAN does not survive outside the switch.
- Frames in one group are not forwarded to the ports that are not also in the group



- When a frame's destination address is not known by the switch, the frame is flooded only to the ports in its VLAN member list

### 3.2.3.3 VLAN Tunnels

The FM2112 supports two VLAN tunnels, an ad-hoc standard:

- VLAN multicast tunnel
- VLAN unicast tunnel

A VLAN tunnel is a means of suppressing the VLAN checking in some circumstances. Normally the VLAN membership list is "anded" with the destination mask to determine the destination port(s) of the traffic and check for boundary violations. However under some circumstances it is desirable to make the VLANs more permissive.

A VLAN multicast tunnel suppresses the membership mask check of the destination address for multicast traffic only.

The VLAN unicast tunnel suppresses the membership mask check for unicast traffic that is static (the lock bit is set in the MAC address Table). VLAN unicast tunnel is only supported in shared learning mode.

### 3.2.3.4 Double VLAN Tagging

Double VLAN tagging simply adds another layer of IEEE 802.1Q tag (called "outer tag") to the 802.1Q tagged packets that enter the network. The purpose is to expand the VLAN space by tagging the tagged packets, thus producing a "double-tagged" frame. The expanded VLAN space allows the service provider to provide certain services, such as Internet access on specific VLANs for specific customers, and yet still allows the service provider to provide other types of services for their other customers on other VLANs.

The FM2000 does support double VLAN tagging by providing the ability to the user to configure any port to systematically tag all packets received regardless if they are already VLAN tagged or not. This is enabled via `SYS_PORT_CFG_1: TagAllPackets`. The ethernet type used for the outer tag on the outbound packets depends on whether the packet was received tagged or untagged. If the packet was received untagged, then the new tag will be of type 8100 as defined in 802.1Q. If the packet was tagged, then the new tag is defined in the `MAC_CFG_1:VlanEtherType` register.

### 3.2.4 Network Topology and Spanning Tree Protocol (STP)

The FM2112 is fully compliant with IEEE 802.1D-2003, and supports:

- Spanning Tree Protocol (STP)
- Rapid Spanning Tree Protocol (RSTP)
- Multiple Spanning Tree Protocol (MSTP).



To support proprietary BPDU addresses, it is possible to use a non-reserved multicast address. The address can be configured in the MAC address table, and VLAN multicast tunnel may be used to prevent this configuration from taking multiple table entries.

The Intel® Ethernet Switch Family supports two learning modes:

- SVL Bridge: Shared VLAN Learning bridge. All of the VLANs are mapped to the same Forwarding information database (FID).
- IVL Bridge: Independent VLAN Learning bridge. Each VLAN is mapped to its own FID. In this case, the VLAN is an extension of the MAC address, and the table is searched with a 60 bit key instead of a 48 bit key. Furthermore independent port state is stored in the VLAN ID table for disabled, listening, learning, and forwarding.

To enable the spanning tree algorithm, the Intel® Ethernet Switch Family supports the following port states

- Disabled: The port drops all packets on Ingress and Egress.
- Listening: The port drops all packets except BPDUs
- Learning: The port drops all packets except BPDUs and on Ingress, the port learns addresses
- Forwarding: The port forwards all packets normally.

The Intel® Ethernet Switch Family stores this state in the VLAN table. There are 4094 vectors of per-port spanning tree state. In independent learning mode, all port state is independent. In shared learning mode, the port state with VLAN ID 0 is used for all VLANs on all ports.

### 3.2.5 Multicast and Protocol Traps

{Described in registers [Table 64](#), [Table 66](#), [Table 67](#), and [Table 68](#)}

#### 3.2.5.1 MAC Address Traps

The reserved group addresses supported by the Intel® Ethernet Switch Family are:

0xFFFFFFFFFFFFFFF	=> Broadcast
0x0180C2000000	=> Spanning tree
0x0180C2000001	=> Pause
0x0180C2000002	=> Link aggregation
0x0180C2000003	=> Port authentication (802.1X)
0x0180C2000020	=> GMRP
0x0180C2000021	=> GVRP
0x01005E000001	=> IGMP v3 query

The switch has the ability to trap frames of some special multicast addresses. Each trap is separately enabled. The traps are:

- BPDU - Spanning Tree : 0x0180C2000000
- LACP - Link Aggregation Control Protocol: 0x0180C2000002
- Port Authentication: 0x0180C2000003



- GARP - Both GMRP and GVRP: 0x0180C2000020-1
- IGMP v3: 0x01005E000001
- All other IEEE: 0x0180C20000xy: where x=0 & y > 3, x=1, or x=2 & y > 1.

*Note:* Broadcast is also sent to the CPU, however it is not a trap.

When a frame is trapped, it is sent to the CPU instead of being treated as a general multicast address. The hardware uses a special internal priority for this transfer, and that prevents the frames from being dropped for PWD calculations, except in the case where the entire memory would fill up.

### 3.2.5.2 CPU MAC Address

In parallel with the MAC address lookup and the protocol multicast address traps, there is a programmable register on which a lookup is performed every cycle. If the destination address matches this register then the frame is sent to the CPU port irrespective of VLAN. However, source address lookups for security and triggers still apply. Ingress rules apply to the frame, but Egress rules do not.

### 3.2.5.3 Ether-type Trap

There is also a configurable Ether-type trap. Any frame that matches the Ether-type will be trapped, and not forwarded normally.

### 3.2.5.4 Multicast Groups

Any entry in the MAC address table may be a multicast group. Therefore, there may be up to 16k multicast entries. Flooding may be used to forward any multicast group for which there is no entry configured in the MAC address table.

## 3.2.6 MAC Address Table and VLAN Table

{Described in registers [Table 79](#), [Table 84](#), and [Table 85](#)}

The Intel® Ethernet Switch Family supports a 16k-entry MAC address table. Any of the 16k entries may be a unicast or a multicast address. The table is an 8-way set-associative hash table.

The table has the following fields:

- MAC Address
- FID: Learning group; for multiple spanning trees this is equal to the VLAN-ID, for shared spanning trees it is equal to zero.
- Valid: Entry is valid
- Lock: Manager has specified this address and switch may not age it out.
- Age: Age time stamp
- Parity



- TRIG-ID: User defined triggers
- Destination Mask: Bit mask for ports associated with this address. One-hot encoding for unicast traffic.

The hash function supports address aliasing resolution. The 32-bit CRC hash function reduces the 60 bit MAC address +VLAN ID to a 16 bit number. Only 12 bits of this are used as the address to the look-up. The FM2112 allows any three of four groups of bits to be selected as the input to the hash function. Performance analysis indicates there is a very low probability of address aliasing (when multiple distinct MAC addresses +VLANs point to the same address) of greater than 8 bins for normal MAC address populations. However, if an address occurrence happens, and there is an unacceptable level of flooding, then the hash input may be changed and the table repopulated to resolve the corner case.

### **3.2.7 Lookups and Forwarding**

#### **3.2.7.1 Source Address Check**

The source address is searched for four reasons:

- Discard and redirection rules
- Security
- Triggers: Can be programmed on source address
- Learning

If all of the features that require a source address check are turned off, then the check may be disabled to save power. Furthermore, the device provides a configurable over-provisioned mode in which the source address search is done on a best-effort basis.

#### **3.2.7.2 Destination Address**

The destination address and VLAN is searched for the following:

- Filtering information (multicast reduced to unicast)
- Traps: Special multicast addresses
- User-defined triggers

#### **3.2.7.3 VLAN ID**

The VLAN ID is searched for the following:

- Ingress and Egress member-list
- Tag processing
- Spanning tree state
- User-defined triggers
- VLAN statistics



### 3.2.8 Forwarding

{Described in registers [Table 64](#)}

Forwarding relay rules are fully compliant with IEEE 802.1Q-2004 (see clause 7 for details).

#### Flooding

When the lookup returns an unknown destination address, the frame is “flooded.” A flood is a normal forwarding that goes out of all switch ports (subject to VLAN membership).

- Either a unicast address or a multicast address that is not in the table is flooded
- When a frame is flooded it is never sent to the CPU port
- If the frame is a broadcast packet, destination address = xFFFFFFFFFFFF, then the packet is sent out of all ports and the CPU

Flooding policy on a DLF is configurable

- Flood both unicast and multicast
- Do not flood unicast (discard), flood multicast
- Do not flood unicast (discard), do not flood multicast (discard)

### 3.2.9 Discard and Monitoring: User-defined Triggers

{Described in registers [Table 92](#) through [Table 95](#)}

In addition to the trapping, discarding, and forwarding rules described above that implement various IEEE protocols, the Intel® Ethernet Switch Family also contains a general set of rules for trapping, redirecting, and discarding traffic. These rules are user programmable and are referred to as “triggers.”

A trigger is a programmable Boolean expression. If all of the conditions defined in the expression are true, then the trigger “fires” and one of a programmable set of actions is taken other than the normal forwarding of the packet.

The trigger programmable conditions are as follows:

- One MAC
  - The MAC address trigger field in the MAC address table indicates this trigger number
  - If either the source address or the destination address matches, then fire the rule. This is useful for monitoring all of the traffic between one MAC address and the rest of the network.
- Both MAC lookup miss
- Both MAC lookup match
  - The trigger field in the MAC address table indicates this trigger number
- Destination MAC address lookup match



- Destination MAC address lookup miss
- Source MAC address lookup match
- Source MAC address lookup miss
- Source Port
  - Configured in trigger source port register
- Destination Port
  - Configured in trigger destination port register
- VLAN
  - The trigger field in the VLAN ID table indicates this trigger number
- Unicast
- Broadcast
- Multicast
- Priority
  - Configured in trigger priority register

The trigger actions are as follows:

- Forward normally but count frames that triggered
- Redirect
  - Do not forward to the MAC address table-configured destination, and instead forward to a specified port (monitoring or CPU)
- Mirror
  - Forward both to the port indicated in tpeified port.
- Discard

Whenever a trigger fires, the count associated with that trigger is incremented. For more information see Section 3.4.

There are 16 separate programmable triggers. Each trigger has identical capabilities. There are 5 bits for triggers in the MAC address table and VLAN ID Table, allowing for future expansion to 32 triggers.

### Limits and Special Conditions

While triggers are very general, as a result of filtering rule precedence, there is a fundamental limit to their use. That is, a frame that has been discarded as a result of the spanning tree state, an IEEE reserved trap, a MAC security violation, or an ingress VLAN filtering rule, is not subject to triggers. Furthermore, if a frame is redirected as a result of the triggers, it is still subject to congestion management, and may not reach its ultimate destination. Triggers have a higher precedence than DLF drops.

The redirection and/or monitoring port is a physical port, not a logical port. This is done so that link-aggregation and triggers may be processed in parallel.



### 3.2.10 Link-Aggregation

{Described in registers [Table 86](#) through [Table 91](#)}

The FM2112 is fully compliant with the link aggregation spec with IEEE 802.3ad-2000, conversely IEEE 802.3-2002 clause 43.

The FM2112 implements all necessary functionality in hardware for high performance link aggregation. However, it does require a control processor to implement the control protocols. LACP and Marker protocols are trapped to the CPU for processing in software.

There can be up to 12 ports in a trunk group. There are up to 12 trunk groups in the FM2112. No port may be in multiple trunk groups. These rules are not enforced in the hardware, it is up to software to follow them.

A hash distribution function is used to index the physical port in the trunk group. The input into the hash function is configurable to include any of the following

- Destination address
- Source address
- Type (If type > 0x600, otherwise this input is zero)
- VLAN-ID
- VLAN-Priority
- Source port - the physical port on which the frame ingressed

The modulus, of the number of ports in the trunk group, is taken of the result of the hash function, yielding the index to the physical port within the trunk group. There is an additional renumbering step to create an arbitrary mapping between the resolved port of the link aggregate group and the actual physical output port, greatly easing the constraints of circuit board layout.

#### 3.2.10.1 Federated Switch Architecture with Link Aggregation

The link aggregation features in conjunction with software support provided in the FM2112 driver enables federated switch architectures with standard Ethernet features.

A federated switch is comprised of "line" switches and "fabric" switches as shown in [Figure 8](#). In a CBB (constant bi-sectional bandwidth) federated switch architecture (aka "Fat Tree"), the bandwidth and port count between the network and the line switch (green links) is the same as the bandwidth between the line switch and the fabric switch (orange links). There are always twice as many line switches as fabric switches.





A maximal configuration 2-tier fat tree has 288 network facing ports and consists of 24 line switches and 12 fabric switches. Each line switch has 12 of its ports facing the network and 12 ports connected to the fabric switches, one port per fabric switch. Sub-maximal configurations are possible, such as a 144-port system with 12 line and 6 fabric switches. In that case, each line switch still has 12 network facing ports, but has 2 ports connected to each of the 6 fabric switches.

The link aggregation hardware features are used to distribute conversations from each line chip across the fabric chips.

- The line chip treats all the fabric chips as being in the same link aggregation group. When an address is not known, it is flooded to only one of the fabric chips, as determined by the hash distribution function.
- The fabric chips view each line chip as being separate (not in the same link aggregation group). When an address is not known, the fabric chip floods the frame to all of the ports except the port that the frame came in on.

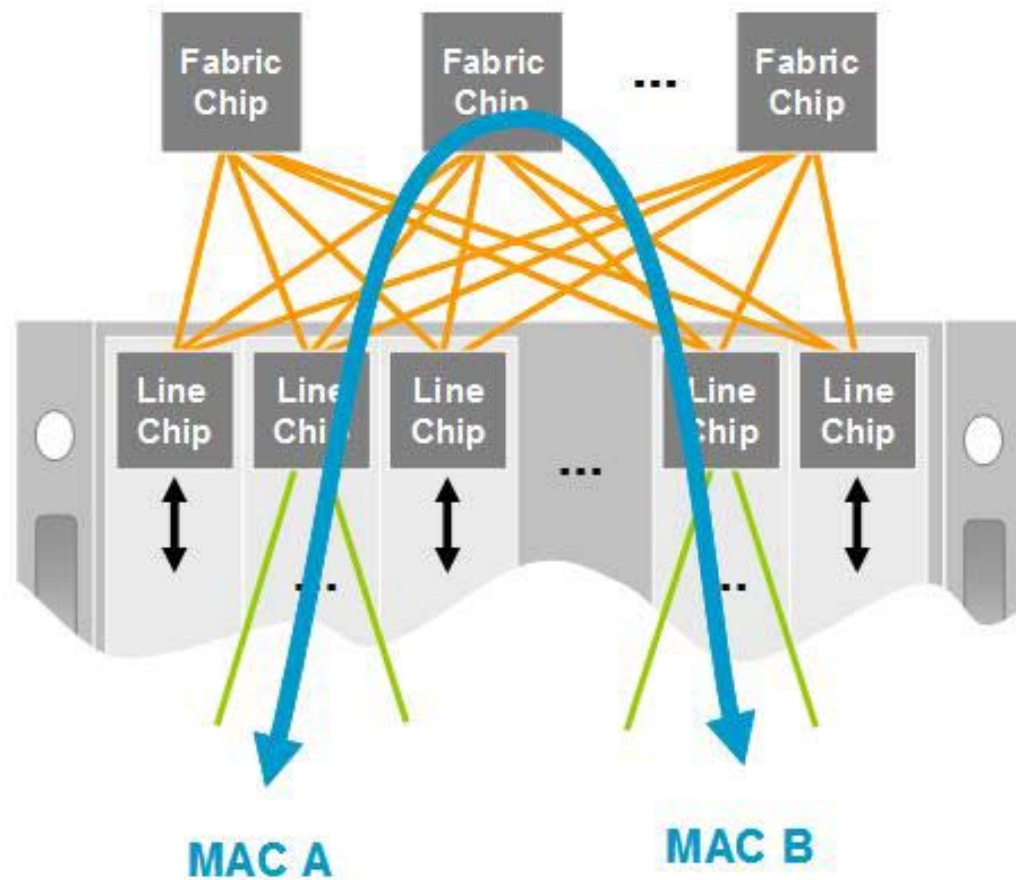

**Figure 8.** Federated Switch Support

The link-aggregation hash function may be configured to produce a symmetrical result for both directions of traffic flow in a conversation. In a conversation between two MAC addresses, MAC A and MAC B, the



source/destination symmetry function will guarantee that frames from A to B and frames from B to A travel the same path through a multi-hop system. This feature enables the use of learning and aging to maintain the table information in a federated switch architecture.

### 3.2.11 Table Modification

{Described in registers [Table 69](#) and [Table 70](#)}

Table entries are dynamic or static.

#### 3.2.11.1 Learning and Aging

Each port is independently configurable for learning. If learning is off, then the only way to add MAC entries to the table is through management. If learning is on, then the switch will add entries to the table after performing a source address lookup.

Aging is a global MAC address table configuration controlled by the `SYS_CFG_7` register (see [Table 69](#)). If the MAC address is dynamic (the lock bit is not set) then entries may be aged out of the table. The configurable times to age the entire table are limited to:

- $32,000 \text{ CPU clock periods} < \text{Age Time} < 6.87 \times 10^{13} \text{ CPU clock periods}$
- Don't age

When a learning or an aging event occurs, the change in the MAC address Table is made available to the CPU and a maskable interrupt is raised. There is a 64-deep queue of MAC address change information. If a burst of learning events happen more quickly than the CPU can service the interrupts, then this FIFO will overflow. In which case, the software image of the table may be resynchronized by reading the hardware table.

If the FM2112 is operated above its guaranteed maximum fully provisioned frame rate, but below its "best effort" maximum frame rate, then the source address look-up rate may be reduced through the best-effort look-up feature. The best effort look-up feature reduces the source address look-up rate when the frame rate is sufficiently high that the look-up would otherwise begin to drop frames. In this rare case, learning becomes statistical.

#### 3.2.11.2 Static Configuration

The switch does not modify static entries in the MAC Table.

The manager may make an entry static, by setting the lock bit.



### 3.2.11.3 Table Access Atomicity

Accesses to the MAC address table's 12 byte (3 word) MAC addresses are atomic. A cache atomically refills a new entry when the lowest order word of a table entry is read. And when the top word in the cache is written, then the whole line is atomically written to the table.

### 3.2.12 Memory Integrity

{Described in registers [Table 53](#) through [Table 55](#)}

The FM2112 tables are protected with parity. There are different policies for parity errors depending on the severity of the outcome. No parity errors are correctable in the hardware. The following is a summary of the checking of parity errors and the actions on discovery of a parity error:

- Frame memory
  - Parity is checked indirectly by checking the RX and TX CRCs. The switch generates an error if the RX CRC is good but the TX CRC is bad. The parity error is counted. This parity error cannot lead to an illegal state.
  - If the switch memory generates a parity error, the frame is transmitted with a forced bad CRC whether the frame was cut-through or s-n-f.
- Scheduler Memory
  - Parity errors are explicitly checked in the scheduler.
  - Some scheduler parity errors are fatal and the chip should be reset immediately. Others cause a memory leak which may not be necessary to fix immediately.
- MAC address table
  - Parity is explicitly checked in the MAC address Table.
  - If a parity error is discovered, that MAC address line is treated as invalid, as if the valid bit were set to zero.
    - If the entry had been learned, then the error is self-correcting as the entry will simply be relearned.
    - However if the entry were statically configured, it must be rewritten by software.
  - A parity error interrupt is raised.
- VID/FID table
  - Parity is explicitly checked in the VID/FID table.
  - If a parity error is discovered the VID and FID entry for that VID TAG is treated as invalid. This means that all frames on that VLAN are discarded until the entry is rewritten by software.
  - A parity error interrupt is raised.

## 3.3 Congestion Management

The FM2112 supports a rich set of congestion management features. [Figure 9](#) illustrates the flow frame data and control through the FM2112.

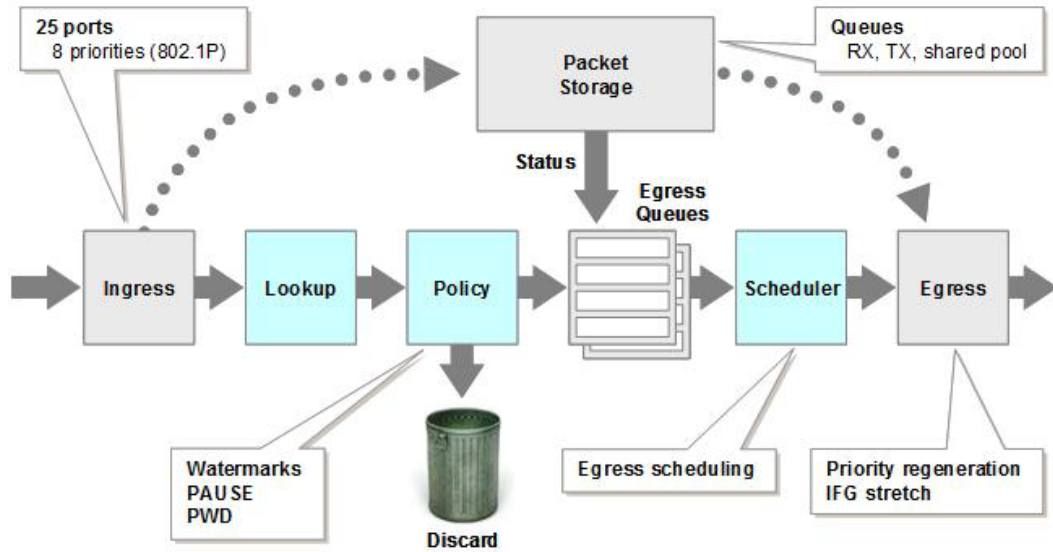

Figure 9. Congestion Management Architecture

### 3.3.1 Priority Mapping

{Described in registers [Table 96](#) through [Table 99](#), [Table 161](#), and [Table 162](#)}

Priority is used to separate traffic into different ordering domains, with differentiated service for each ordering domain. There are 5 types of priority classes in the Intel® Ethernet Switch Family: Ingress (25\*8=200), Switch (16), Egress (25\*8=200), PWD (16) and Egress Scheduling (4), related through mapping functions. Ingress priority is the 3 bit VLAN priority tag that appears on all tagged frames. The Egress Priority has no effect on the switch, it is simply the tag presented to the outside network on each frame.

In addition, user defined triggers, see section 3.2.9, can establish a switch priority based on any trigger rule. This is helpful for applications in which using VLAN priority tagging is not the preferred way of establishing priority.

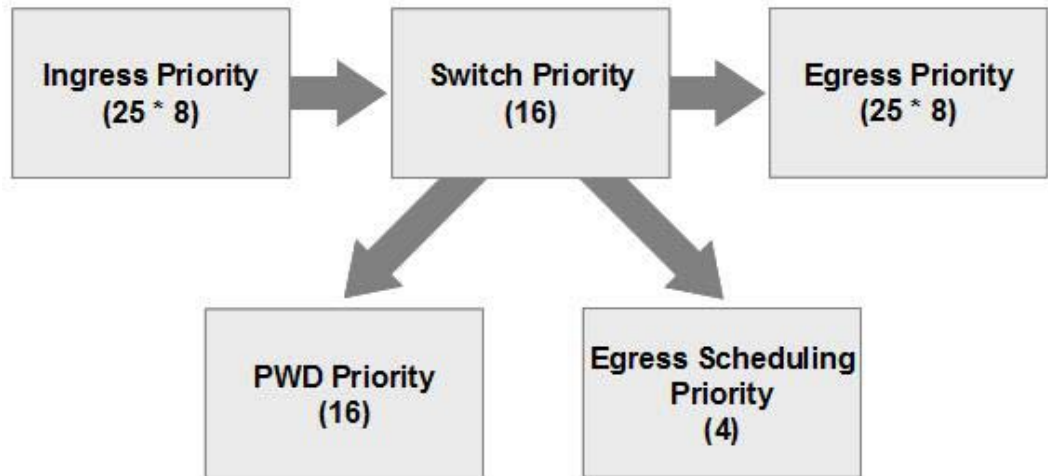

Figure 10. Priority Mapping

### 3.3.1.1 Priority Regeneration

The FM2112 supports priority regeneration where the ingress priorities map to different egress priorities. Up to 8 priorities can be remapped without having any effect on the other PWD or egress scheduling priorities. To remap a priority, the Ingress VLAN priority is mapped to a switch priority 8-15 and that priority is configured with the desired egress priority. The mapping to PWD and egress scheduling must still be configured as they were in switch priorities 0-7.

### 3.3.2 Shared Memory Queues

{Described in registers [Table 101](#) through [Table 107](#), [Table 110](#) and [Table 111](#)}

*Note:* Weights assigned to queues in Strict Priority mode have no relevance.

The FM2112's shared memory architecture allows the construction of queues of variable sizes. A memory segment in the Intel® Ethernet Switch Family has an "association" with multiple queue resources. This association is used to track queue status on which PWD and Pause are based.

There are three types of status or "segment association" reported by the switch element. They are RX port, TX port, and shared pool.

- A segment maintains its RX and global association from when the memory is initially allocated to when it is freed after transmission.
- The TX port association is established once the forwarding information for that frame is determined, and it is freed after transmission. In multicast, it is freed after transmission to the last port.



- The shared pool status specifies how full the memory is that is shared between the different ports. The total available shared pool is defined as the total memory minus the sum of each ports private memory.

The Intel® Ethernet Switch Family supports the following watermarks,

- RX-Private (per port, both Pause and PWD)
  - Frames from the  $i^{\text{th}}$  RX port may use  $i^{\text{th}}$  RX-Private queue.
  - The sum of the  $RX_i$ -Private total memory (1MB).
  - RX-Private is the same for both Pause and PWD
- RX-Shared and TX-Shared watermarks for Pause and PWD
  - Shared watermarks are “Hog watermarks” and once the occupancy exceeds the watermarks, either the ports are paused or the frames are dropped with 100% probability. Note that the pause or drop decision for a frame is made based upon the queue occupancy at its time of arrival and before that frame is added to that queue. If a WM is set to 32, for example, the 33d frame will not be paused/dropped because the WM has not been exceeded. The 34<sup>th</sup> frame to be considered for that queue will be dropped/paused because the WM has now been exceeded.
  - While an RX queue occupancy is between RX-Private and RX-Shared, the switch may pause the RX port or drop frames for PWD.
  - The user must set  $RX_i$ -Shared >  $RX_i$ -Private.
- Global PWD watermarks
  - Low - The lower PWD watermark.
  - High - The upper PWD watermark.
- Global Privileged watermark
  - Prevents MAC overflow

### 3.3.2.1 Queue configuration

For all of the watermarks, the queue size is an integral number of 1024 bytes. The size 1024 bytes is a convenience of the PWD and Pause processing, and does not reflect the segment size of the memory.

### 3.3.3 PWD (Priority Weighted Discard)

The FM2112 uses a PWD (Priority Weighted Discard) to protect queue resources preferentially for higher priority tagged frames. [Figure 11](#) shows a queue without PWD and a queue with the FM2112's implementation of PWD. The solid/dotted lines represent different PWD priorities, where the different priorities begin 100% drop at user assigned queue occupancy levels. This makes the PWD implementation a superset of the simple queue.

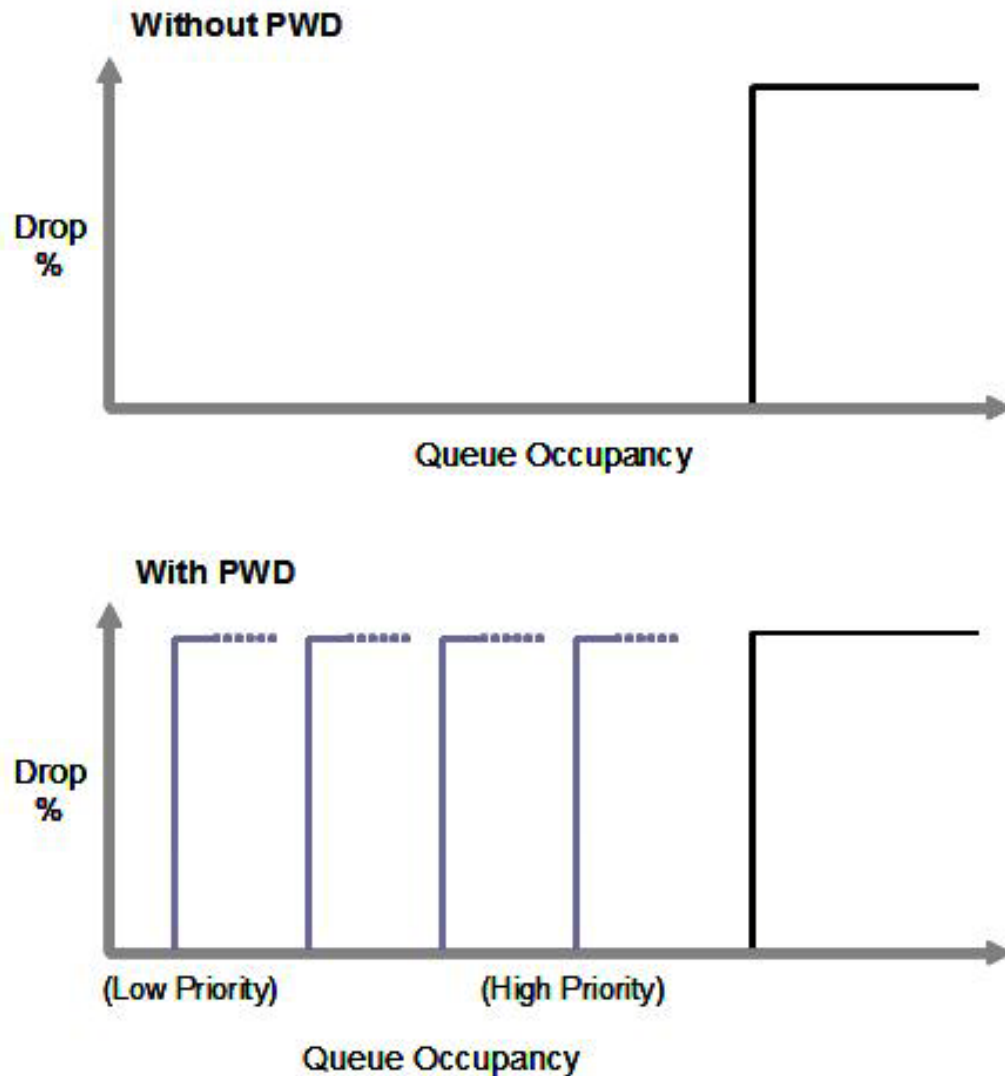

Figure 11. PWD Implementation

### 3.3.3.1 Tail Drop versus PWD

In the FM2112, there are five rules for discarding frames for congestion management:

- The Rx shared watermark for discard is exceeded:  $rx_i > RxSD_i \rightarrow 100\%$  packet drop. [PWD is not used in this case, it is 100% drop].
- The Tx shared watermark for discard is exceeded:  $tx_i > TxSD_i \rightarrow 100\%$  packet drop. [PWD is not used in this case, it is 100% drop].
- The global-PWD-low discard watermark is exceeded and for this switch priority and traffic type, it is configured to check against the low watermark;  $sum(y_i) > GLD$  (Global Low Discard). PWD is applied to GLD.
- The global-PWD-high discard watermark is exceeded and for this switch priority and traffic type, it is configured to check against the high watermark;  $sum(y_i) >$



GHD (Global High Discard). PWD is applied to GHD. GHD should be greater than GLD.

- The Global Privilege watermark is exceeded:  $g > GPD$  (Global Privilege Discard) → 100% packet drop. This is set to the highest watermark. In this case,  $g$  is taken as the total memory used. Not just the memory in the shared pool.

### 3.3.3.2 PWD Calculation

The algorithm for PWD is

- Compute the occupancy level at which 100% drop begins for the priority in question
  - The priority is the internal switch priority as determined by RX\_PRI\_MAP
  - The queue occupancy is the actual occupancy in KB of the shared memory and excludes the private per-port queue.
  - In the Intel® Ethernet Switch Family there is only one PWD calculation per packet, even though there are multiple watermark checks.

The equations describing the drop characteristics are:

#### Equation 1

$$\left\{ 0\% \mid x < \left( WM - \frac{1024}{2^{S\{3:1\}} * 3^{S\{0\}}} \right) \right\}$$

$$\left\{ 100\% \mid x \geq \left( WM - \frac{1024}{2^{S\{3:1\}} * 3^{S\{0\}}} \right) \right\}$$

Where:

- WM - Watermark: either GLD or GHD watermarks (See [Table 104](#))
- x - status value for the queue
- s - PWD slope configuration - 4 bit quantity (see [Table 97](#) and [Table 98](#)).

### 3.3.4 Pause Flow Control

The FM2112 is fully compliant with IEEE 802.3x, and IEEE 802.3-2002 clause 31 and Annex 31a and Annex 31b.

The Intel® Ethernet Switch Family will signal pause-on for two reasons. Either a single port has exceeded its max allotment of the shared memory, or the global memory is too full and the port has exceeded its private memory allotment. This is defined with the following equations:





## Equation 2

$$y_i : \max(rx_i - RxPv_i, 0)$$

$$\left( rx_i > RxsP_i^h \mid \left( y_i > 0 \ \& \ \sum_i y_i > GP^h \right) \right) \ \& \ pause_i == 0 \rightarrow pause_i = 1$$

$$\left( rx_i < RxsP_i^l \ \& \ \left( y_i == 0 \mid \sum_i y_i < GP^l \right) \right) \ \& \ pause_i == 1 \rightarrow pause_i = 0$$

The global watermark default (see Note: Weights assigned to queues in Strict Priority mode have no relevance, [Table 110](#)) is 0x144, corresponding to 324 kB, or about 13.8 kB per port. Private watermark default (see [Table 102](#)) is 16.4 kB per port. The condition for signaling pause-on where a port exceeds its private watermark while the global watermark is also exceeded is:

$$1024\text{kB (total memory)} - [13\text{kB (global WM)} \times 24 \text{ ports}] - [16\text{kB (default RxPvi)} \times 24]$$

which leaves 300 kB unused in the switch, or about 12.5kB/port. For lossless flow control, 2 packets of 2kB each must be stored, leaving over 8kB per port of “wire delay” or “bytes in flight” that can be stored.

Where the following are defined as:

- $pause_i$  - The pause state of the  $i^{\text{th}}$  port.
- $rx_i$  - Number of active 1024 byte segments associated with the Rx of port  $i$ .
- $RxsP_i^h$  - Rx shared pause-on watermark for the  $i^{\text{th}}$  port.
- $RxsP_i^l$  - Rx shared pause-off watermark for the  $i^{\text{th}}$  port.
- $GP^h$  - Global Pause-on watermark.
- $GP^l$  - Global Pause-off watermark.
- $RxPv_i$  - Rx private watermark for the  $i^{\text{th}}$  port.

The rate of signaling pause messages is independent of the status crossing the pause on/off watermarks, and separately configured.

The Intel® Ethernet Switch Family supports the following Pause features:

- Pause on/off based on Equation 2.
- Configurable Pause timer
- Configurable Pause watermarks, including configurable hysteresis between on and off.
- Asymmetric Pause
  - Rx may respond to Pause while TX never transmits pause messages.
  - Rx may be configured to ignore Pause while TX produces pause messages.
  - Both Rx and Tx may be configured to ignore pause and not transmit pause
  - Both Rx and Tx may be configured to respect pause and transmit pause as specified in IEEE 802.3x



Turning the Pause feature off is accomplished by setting the watermarks for Pause to a level which is higher than the device can attain.

### 3.3.5 Egress Scheduling

{Described in registers [Table 108](#) and [Table 109](#)}

Egress scheduling is the rules applied to determine which frames are to be transmitted next on the port from the Egress Scheduling Priority Queues (ESPQ). The priority used to determine the scheduling is the Egress Scheduling Priority, which is defined in section 3.3.1. Egress scheduling is an independent function on each output port. In the Intel® Ethernet Switch Family, Egress Scheduling is based on the number of frames transmitted, not on bytes transmitted or number of segments transmitted.

There are two scheduling modes,

- Strict Priority - Always schedule the frame of the highest priority queue that is ready to transmit
- "Priority Weighted Round Robin" - Service the priority queues in round-robin fashion, scheduling a weighted number of frames per turn per queue. The order in which frames between queues are scheduled, up to the ESPQs' weights, is configurable
  - In priority order, using credit only as the ESPQ is serviced.
  - Pure round robin: schedule the number of frames equal to the weight or until the queue is empty then proceed to the next queue.

Each priority queue can be in either scheduling mode. That is, some queues could be strict priority while other queues are WRR. This is implemented internally with the following constructs:

#### Eligibility

- An ESPQ is said to be eligible if and only if at least one frame within the queue is ready to be transmitted.
  - In store-n-forward mode this means the whole frame is in the ESPQ.
  - In cut-through mode, this means the head sub-segment is in the ESPQ.

#### Initial Credit

- The initial credit is the weight given to the ESPQ. It is the number of frames the queue may schedule per turn.

#### Credit Decrementing

- A strict priority ESPQ never loses credit
- A WRR ESPQ loses credit depending on the service algorithm
  - In priority Order (PO), the ESPQ loses one credit per frame transmitted
  - In Pure Round Robin (PRR), the ESPQ loses one credit per frame transmitted, and all remaining credits once it is not eligible.



### Credit Adding

- In strict priority there is no need to ever add credits
- In WRR credits are added depending on the service algorithm
  - PO - The ESPQ gains its weight of credits once there are no credits left for all eligible ESPQs
  - PRR - All ESPQs are reset to their weight once there are no more credits in any ESPQ

### Weights, Queues and Configuration

- There are 4 ESPQs per port
- Each ESPQ has a 8 bit weight, giving a range of 1-255. The value 0 is illegal.
- The default is strict priority
- Each ESPQ has a configuration between strict and WRR
- For all the WRR ports, the global service algorithm is configurable between PO and PRR.

#### 3.3.5.1 Jitter Buffers

{Described in register [Table 114](#)}

The FM2112 has jitter buffers on either side of the switch element datapath (SED) to prevent RX overflow and TX underflow.

#### Size and Configuration

- RX jitter buffer
  - 256 bytes
  - No configuration
- TX jitter buffer
  - 256 bytes
  - Cut-through Watermark configurable from 8 to 256 bytes in word increments
  - Store-n-Forward Watermark configurable from 8 to 256 bytes in word increments
- Latency
  - The RX jitter buffer adds 50 ns latency (one 64-byte subsegment) to packet transmission regardless of size.
  - The TX jitter buffer adds no more latency than its size / data-rate as configured by the watermarks.
  - However, the last 64 byte segment of a packet is scheduled irrespective of the occupancy assuming the occupancy is greater than 8 bytes. A 64 byte frame is therefore transmitted without an occupancy-watermark check.

### 3.4 Statistics

{Described in registers [Table 117](#) through [Table 129](#)}



The FM2112 keeps packet statistics compliant with IETF RFC 2819, and additional statistics for proprietary features. The general principle is “any time a switch takes action on a frame, count the action.

Statistics are divided into groups. Only one counter within a group is exercised on any given frame. See section 5.7 for a complete list of the counters. The groups are:

- RMON RX frames by type
- RMON RX frames by size
- RMON RX octets
- RMON RX frame by priority
- RMON RX octets by priority
- RX forwarding action
- RMON TX frames by type
- RMON TX frames by size
- RMON TX octets
- Switch frame drops by Congestion Management
- Switch frame forwarded by VLAN
- Switch bytes forwarded by VLAN
- Switch Triggers

All counters in the Intel® Ethernet Switch Family are 64 bits. There is no event rate requirement for reading the statistics for even the byte counters on the order of the lifetime of the chip. The counters are read 32 bits at a time. Bandwidth over the CPU interface may be saved by reading only the lower 32 bits of the counters.

There are other counters in the chip for debug purposes in both the EPL and the MAC table status. See their respective sections for a description of their debug counters.

Counters may be reset to 0 by executing a write access into the counter. The 64-bit counters are reset to 0 regardless of which 32-bit word (high or low) is written and the value written is a don't care.

### 3.5 Management

The chip management block includes the following components:

- BOOT FSM (Master/Slave)
- LCI (Slave)
- SPI (Master)
- CPU Interface (Master)
- JTAG (Master)
- LED (Master)
- JTAG2MGMT (Master)



- SWITCH MGMT (Slave)
- PORT MGMT (Slave)

Figure 12 shows the management infrastructure.

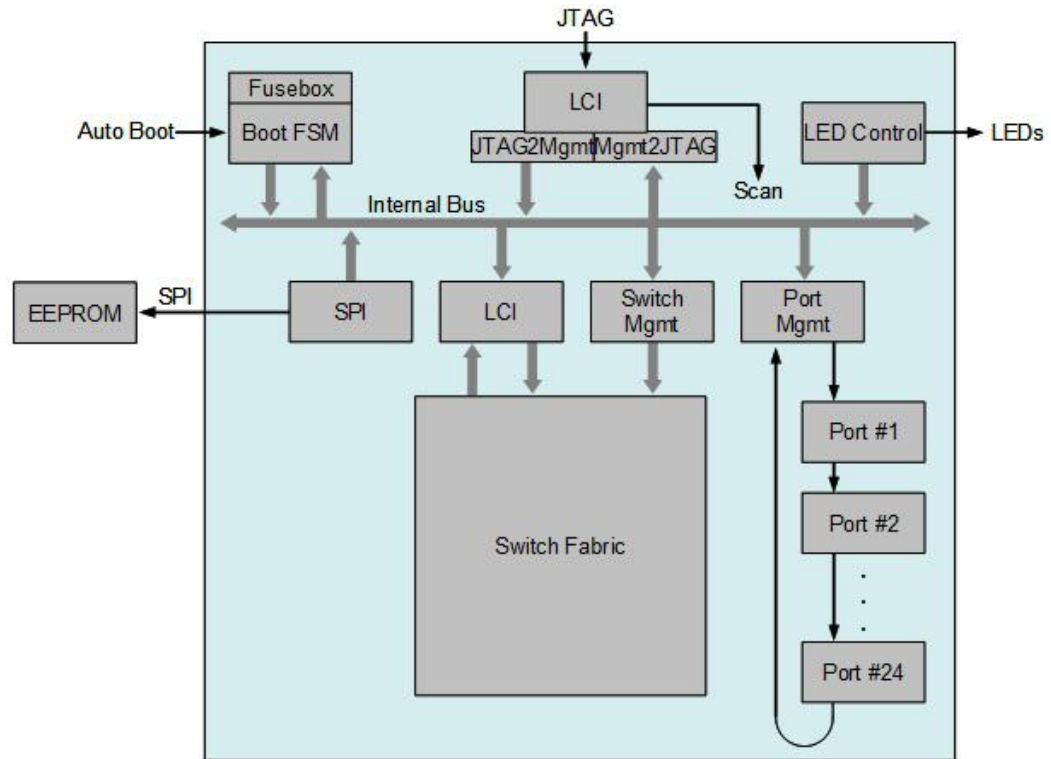

Figure 12. Intel® Ethernet Switch Family Management Infrastructure

A master component is a component capable of issuing commands (read or write) on the management bus, a slave component is a component capable to receive such commands and execute but is not capable to generate one.

The components are defined here and detailed in the next sections:

- CPU Interface: The interface used by a local CPU to manage the device.
- JTAG: The interface used to access the boundary scan chain or the internal scan chains (diagnostic or RAM repair).
- JTAG2MGMT: A bridge from JTAG to the internal bus. The bridge allows an external device connected to the JTAG interface to access the internal management bus and thus any slave device on that bus.
- MGMT2JTAG: A bridge from the internal bus to JTAG. The bridge allows a bus master (CPU Interface, BOOT FSM, or EEPROM) to access internal scan chains.
- LCI: Logical CPU Interface. The port used to send or receive packets from the switch.
- SPI: Serial Port Interface. An interface to an external serial EEPROM.



BOOT FSM:	The bootstrap finite state machine. This is activated once at startup to setup internal registers, repair internal RAM and initialize memory.
SWITCH MGMT:	Interface to manage the switch, this include setting up any frame control registers, access to global statistics and accessing the lookup table.
PORT MGMT:	Interface to manage the port.
LED CTRL:	A block that retrieves the status of the port and present it to a serial LED interface.

### 3.5.1 Logical CPU Interface

{Described in [Table 73](#) through [Table 76](#)}

The FM2112 supports packet transmission to any port of the switch and reception from any port of the switch to the local CPU controller through the CPU Interface. However, this interface is a slave only bus interface. There is no built in DMA controller to retrieve packets from memory for transmission or forward packets received to internal memory. Packet transmission and reception requires the CPU Interface master to write or read each word of a packet transmitted or received.

The FM2112 provides DMA signals allowing the usage of an external dual-channel DMA controller to do the data transfer for the CPU. This is shown in [Figure 13](#).

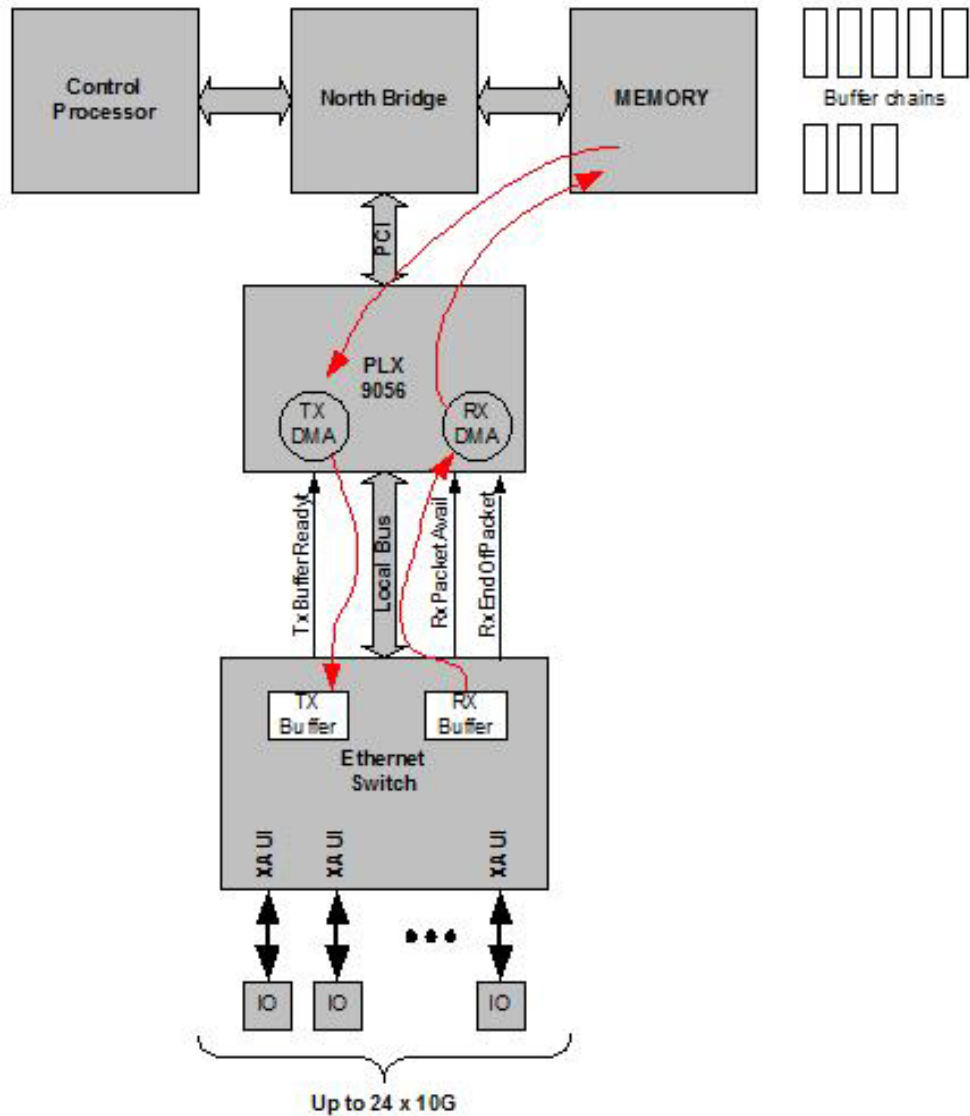

Figure 13. Example of Intel® Ethernet Switch Family with a PCI DMA Controller

### 3.5.1.1 Packet Transmission and Reception without a DMA Controller

In absence of DMA controller, the data transfer protocol is the following:

#### Packet transmission

- Check that the transmitter is ready by reading the TXRDY bit of the LCI\_STATUS register. If not ready, either poll this bit until the transmitter is ready or enable an interrupt to wait for this status.
- Write the packet length word into the LCI\_TX\_FIFO register as described in Table 76.

- Write the destination mask into the LCI\_TX\_FIFO register as described in [Table 11](#).
- Write frame payload words into the LCI\_TX\_FIFO register. The last word shall be padded by the host if the frame length is not a multiple of 4 bytes.

### Packet reception

- Check that the receiver has data by polling the RXRDY bit of the LCI\_STATUS register
  - The CPU can enable an interrupt to wait for data.
- Read LCI\_RXFIFO.
  - There are three ways to indicate packet completion.
    - The CPU can enable an interrupt to inform it that a packet has finished being sent to it.
    - Read the EOT bit in the LCI\_STATUS register every time that LCI\_RXFIFO is read. The EOT bit indicates end of transmission.
    - Observe the EOT pin on the CPU interface.
    - The second to the last word is the end of the packet data, and it is padded to 32 bits.
    - The last word does not contain any packet data. It is an in-band status word. Its definition is contained in the table RX\_FRAME\_STATUS.

#### 3.5.1.2 Packet Transmission and Reception with a DMA Controller

Packet transmission with an external DMA controller is shown in [Figure 14](#). The external TXRDY\_N signal replicates the TXRDY bit of the LCI\_STATUS register and is asserted whenever the Intel® Ethernet Switch Family can accept a packet word from the CPU. The DMA controller may transfer data words as long as this signal is asserted.

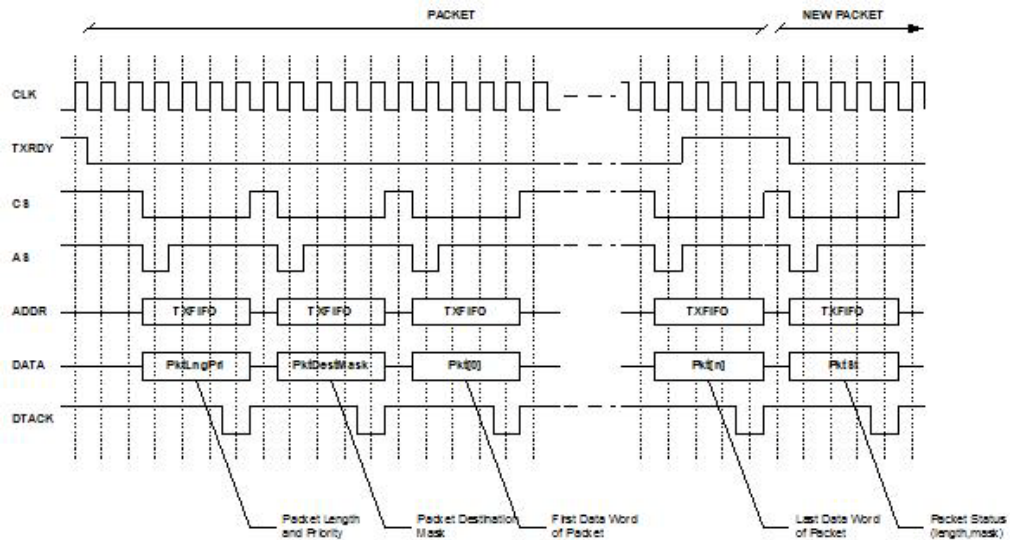

Figure 14. Frame Transmission





Packet reception with an external DMA controller is shown in Figure 15. The RXREQ signal replicates the RXRDY bit of the LCI\_STATUS register and is asserted whenever the Intel® Ethernet Switch Family has a data word available to the CPU. The DMA controller can read data words from packet as long as the signal is asserted. The RXEOT signal is automatically asserted when the last word of a packet is being read (this last word contains the packet length, the source port and the CRC status). The EOT signal allows a DMA controller that has buffer chaining capability to automatically close the current buffer and move to the next one for the next packet without CPU intervention.

The Intel® Ethernet Switch Family has the option to pad the frames to either a 32 bit boundary or a 64-bit boundary. The last 32 bits always contains the status work.

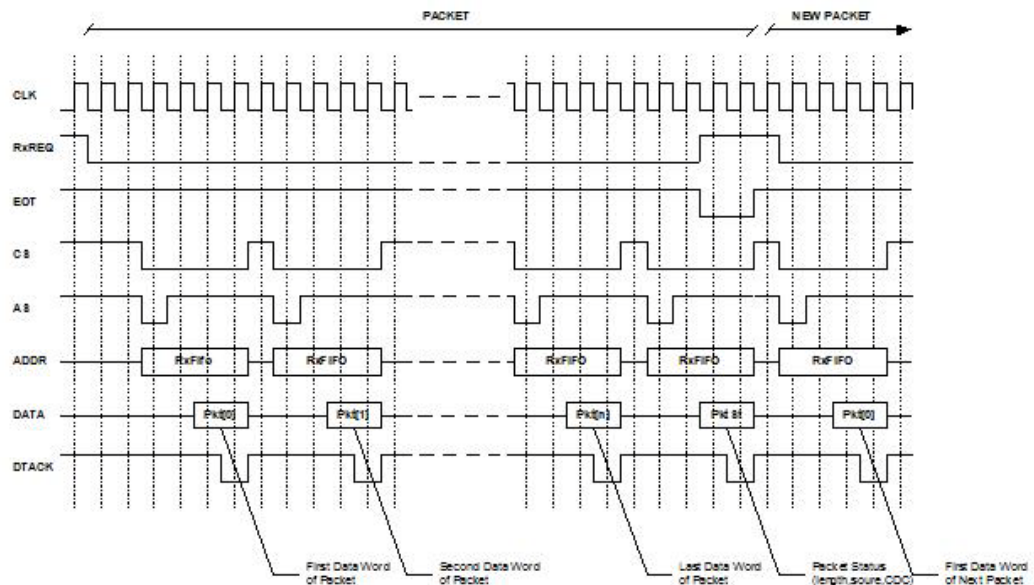

Figure 15. Frame Reception

Implementation notes: It is important that RXREQ is de-asserted at the beginning of the read cycle when there are no more frames in the queue as shown in the figure. This will give enough heads up to the DMA to not start another transfer immediately. The recommend behavior is to de-assert RXREQ only at the end of the frame and at the same time as EOT is asserted and data is driven.

### 3.5.1.3 Little and Big Endian Support

The endianness only affects the position of the bytes within one word. In a big endian processor, the successive bytes of a packet must be stored starting by placing the first byte in the most significant byte location of the memory and moving right. In a little endian processor, the successive bytes of a packet must be store starting by placing the first byte in the least significant byte location and moving left. In the



case of 32 bit quantities, there is no difference between big and little Endian for 32-bit busses. Thus the 3 in-band control words are the same for both little and big Endian. This is illustrated in Table 4 through Table 7.

**Table 4. Packet Transmission on CPU Port in Little Endian**

	31 MSb	24	23	16	15	8	7	0 LSb
First word	LCI_TX_LEN							
Second word	LCI_TX_DMASK							
Payload	frame[3]		frame[2]		frame[1]		frame[0]	
....								
Payload	X		X		X		frame[Length-1]	

**Table 5. Packet Transmission on CPU Port in Big Endian**

	31 MSb	24	23	16	15	8	7	0 LSb
First word	LCI_TX_LEN							
Second word	LCI_TX_DMASK							
Payload	frame[0]		frame[1]		frame[2]		frame[3]	
....								
Payload	frame[Length-1]		X		X		X	

**Table 6. Packet Reception on CPU Port in Little Endian**

	31 MSb	24	23	16	15	8	7	0 LSb
First Status Word	LCI_RX_EXTRA_INFO							
Payload	frame[3]		frame[2]		frame[1]		frame[0]	
....								
Payload	X		X		X		frame[Length-1]	
Second Status Word	LCI_RX_FRAME_STATUS							

**Table 7. Packet Reception on CPU Port in Big Endian**

	31 MSb	24	23	16	15	8	7	0 LSb
First Status Word	LCI_RX_EXTRA_INFO							
Payload	frame[0]		frame[1]		frame[2]		frame[3]	
....								
Payload	frame[Length-1]		X		X		X	
Status Word	LCI_RX_FRAME_STATUS							



### 3.5.1.4 In-band Control Word Definitions

LCI\_RX\_FRAME\_STATUS is appended to the end of a data transmission. Thus the amount of memory taken up in the receive buffer in the host CPU is the packet length + 4 bytes. LCI\_TX\_DMASK and LCI\_TX\_LEN are control words inserted in-band on data transmission. Note that even if the CPU forwarding mode is “forward normally” The control word LCI\_TX\_DMASK is still assumed to be the second word. In this case it is just ignored.

**Table 8. LCI\_RX\_EXTRA\_INFO**

Name	Bit	Description	Type	Default
SrcPort	23:18	Indicates on which port the switch received this frame.		
VLAN Action	17:16	Indicates how the VLAN ID shall be interpreted.  0: Do nothing, the VLAN ID indicated in this register is the same as the VLAN ID in the frame.  1: The VLAN ID indicated in this register is the new VLAN association for this frame and the VLAN tag present in this frame shall be removed.  2: The VLAN ID indicated in this register is the new VLAN association for this frame and shall be added to this frame.  3: The VLAN ID indicates in this register is the new VLAN association for this frame and shall replace the one present in the frame.		
Priority	15:12	Indicates the internal switch priority associated with this frame.		
VLAN ID	11:0	Indicates the VLAN association for this frame.	RO	0
RSVD	31:24	Reserved. Set to 0.	RV	0

**Table 9. LCI\_RX\_FRAME\_STATUS**

Name	Bit	Description	Type	Default
Padding	5:3	The number of bytes in the last word that are not valid	RO	0
Underflow	2	There was an underflow during this frame on the TX side.	RO	0
Tail Error	1	The error bit in the fabric was set for this frame.	RO	0
Bad CRC	0	Packet had a bad CRC	RO	0
RSVD	30:6	Reserved. Set to 0.	RV	0



**Table 10. LCI\_TX\_LEN**

Name	Bit	Description	Type	Default
Switch Mode	31	x0 – Lookup mode – The switch uses the resources of the packet processor to forward the packet, behaving as an ordinary port, and subject to all policy checks of an ordinary port. x1 – Directed mode - The Dmask of LCI_TX_DMASK is used to specify the output port. The switch does not learn or check source addresses in this mode. A frame forwarded in this mode should never be discarded as a reason of policy. Though it is ok to discard this frame for congestion management.	RW	0
Packet Length	15:0	Length of the packet to be transmitted. Includes length of CRC even if the switch is adding the CRC.	RW	0
RSVD	31:16	Reserved. Set to 0.	RV	0

**Table 11. LCI\_TX\_DMASK**

Name	Bit	Description	Type	Default
Dmask	24:1	Destination bit mask of the packet to be transmitted. If any bit of the DMASK is set, then the frame is forwarded in directed mode. If the DMASK=0 then the frame is forwarded in lookup mode.	RW	0
RSVD	31:25; 0	Reserved. Set to 0.	RV	0

### 3.5.1.5 Switching Modes

Frames may be transmitted in either of two modes

#### Directed Mode

- The frame is sent to the output ports without any applied policies.
  - No VLAN, security, spanning tree, or trigger checks.
  - This is a physical port, there is no canonical port resolution.
  - The switch may discard these frames for congestion management
- Source addresses are not learned.
- The LCI may overwrite the CRC field with a correct CRC.
- There is no VLAN tagging or stripping

#### Lookup Mode

- Frame is transmitted as an ordinary packet. The CPU is indistinguishable from any other station on the network.
- The LCI may overwrite the CRC field with a correct CRC.

### 3.5.1.6 Data Integrity

The LCI has CRC generation capability. This is purely a convenience for the CPU.



- If the CRC is enabled then packets transferred from the CPU to the switch do not require a valid CRC. In this case the last four bytes are overwritten with a valid CRC (note: the packet data transmission must include space for the CRC).
- If CRC generation is not enabled, then it is a requirement of software to generate a valid CRC.
- The CRC is not used to check data integrity in the transmission from CPU to the switch. There is a parity check in the CPU Interface for transmission from the CPU to the switch.

### 3.5.2 Bootstrap Finite State Machine

{Described in registers [Table 36](#)}

The BOOT FSM is normally the initial chip manager.

If the AUTOBOOT signal is asserted, then the BOOT FSM starts automatically after RESET is de-asserted, initializing the chip according to the content of fusebox and returning control to the CPU Interface after the initialization is completed.

If the AUTOBOOT signal is de-asserted, then the BOOT FSM will only start if the CPU forces it to start. The CPU in this case will indicate which phases shall be executed. It is not possible to change order, it is only possible to either execute one phase or skip over that phase. Starting the BOOT FSM and defining which phase is executed is controlled by the CHIP\_MODE register.

The BOOT FSM can go through 3 phases: FUSEBOX processing, RAM initialization, EEPROM processing.

#### 3.5.2.1 Boot Phase 1 - Fusebox

During this phase, the BOOT FSM read the fusebox and stores the value read into the FUSEBOX CSRs.

#### 3.5.2.2 Boot Phase 2 - Memory initialization

During this phase, the BOOT FSM initializes the memory to default values and also initializes the list of pointers in the scheduler.

#### 3.5.2.3 Boot Phase 3 - EEPROM Read

#### 3.5.2.4 Chip Bring-up without EEPROM

EEPROM operations will be started if the EEPROM\_ENABLED pin-strap is set.

The SPI FSM will issue one read command to address 24'd0 - the EEPROM will continue to auto-increment through all of its memory. The BOOT FSM will be able to stall the SPI FSM in -order to give time to any required fusebox operations.



#### STEP 1: Taking management out of reset

- Deassert reset (note that both CHIP\_RESET\_N and EBI\_RESET\_N can be tied together)
- Write 0xD04 into CHIP\_MODE
- Poll BOOT\_STATUS periodically until it goes to 0 (will be within few seconds)
- You can now read/write into any management register (read VITAL\_PRODUCT\_DATA as an example)

#### STEP 2: Programming PLL for Frame Processor

- Setup PLL\_FH\_CTRL as desired (depends on FH\_REF\_CLK value)
- Poll PLL\_FH\_STATUS to check it locks, it will normally locks in few microseconds

#### STEP 3: Enabling Frame Processor

- Write 0 into SOFT\_RESET
- You can now read/write into any management register

#### STEP 4: Enabling Ports

- Setup correct reference clock for each port using PORT\_CLK\_SEL (writing 0 in this register will set all ports to use refclk A)
- Take individual ports out of reset using PORT\_RESET (writing 0 will take all ports out of reset).
- Bring-up the serdes as follows:
  - Apply power to all components, including the switch
  - De-assert master reset on board
  - Optional de-assert reset on the switch (but not required at this stage)
  - Processor boots (if processor present)
  - Processor de-assert reset on the switch (if not done)
  - EBI clock must be present on the switch before the reset is deasserted (10 cycles are good enough).

#### 3.5.2.5 Management Bus

The Management bus is used to read / write registers. Access to the management bus is granted with the following precedence.

- BOOT FSM
- JTAG
- CPU Interface

#### 3.5.2.6 Scan Chains Converter

The Scan Chain Converter is a management feature that converts management requests into DFT scan chain requests to grant scan access to the device from the CPU.



The scan chains are used to check the DFT state of the Intel® Ethernet Switch Family. Access to the scan chains are granted with the following precedence:

- External SCAN IF
- JTAG
- Management (CPU Interface or BOOT FSM)

### 3.5.3 CPU Interface

{Described in registers [Table 47](#)}

The CPU interface in the FM2112 is a 24-bit address, 32-bit data bus used to access the registers, tables, and frames. The interface uses a handshaking protocol to allow a variable amount of delay to respond to requests. It supports off-chip DMA functionality.

#### 3.5.3.1 General Description

- Slave-terminated protocol that allows a variable amount of delay to respond to requests
- 32-bit data interface, supporting single, Big Endian, read/write transactions
- Supports parity checking on the data bus
- Interrupt generation
- Support for off-chip DMA PCI bridge devices.
- Maximum frequency range of 66MHz
- Throughput
  - Reads at 528 Mb/s
  - Writes at 1056 Mb/s

#### 3.5.3.2 IO Requirements

- IO power supply = 3.3v
- $V_{IH}$  min = 2v,  $V_{IL}$  max = 0.8v.
- TTL compatibility

#### 3.5.3.3 Register Read/Write Operations

Reads and writes always act on a 32-bit word in the FM2112. Every bus request will always return a response, even if the request was to an unsupported address.

**Table 12. CPU Interface External IO Description**

Signal Name	Direction	Description
ADDR[23:2]	In	Address, word aligned
RW_N	In	Read/Write select
DATA[31:0]	In / Out	Data
PAR[3:0]	In / Out	Data parity per byte

**Table 12. CPU Interface External IO Description (Continued)**

AS_N	In	Address Strobe
CS_N	In	Chip Select
DTACK_N	Out	Data Acknowledge
DERR	Out	Data Error
INTR_N	Out	Interrupt
CPU_RESET_N	In	Reset

**3.5.3.4 CPU Interface Operation**

The CPU Interface timing diagrams are shown in [Figure 17](#) and [Figure 18](#). All input signals and all output signals are driven (or tri-stated) at the rising edge of CLK.

There are two main control signals - one to qualify the incoming request (AS\_N) and the other to qualify the completion of the request (DTACK\_N). There are no timing requirements from the start to the completion of a request. A write will always complete its request on the next cycle following a write request.

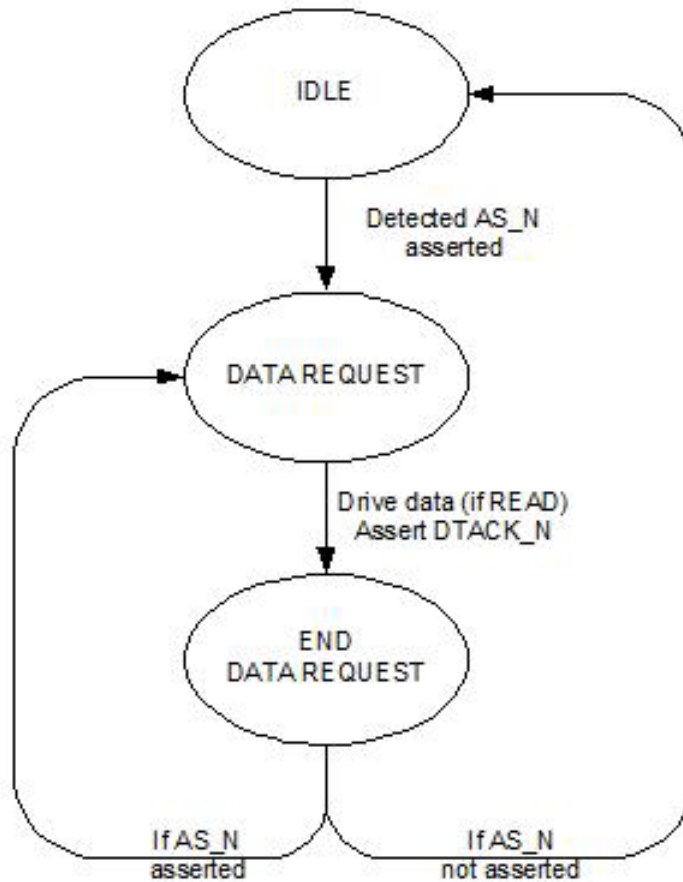

**Figure 16. CPU Bus Interface State Diagram**



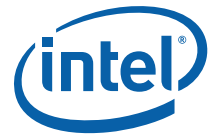

### CPU Interface address space

The Chip-Level address space 0x00000-0x000FF is for the CPU Interface. There are no physical registers within it but if a read to this address range occurs then {31'd0,CPU\_I\_STALL} will be returned. CPU\_I\_STALL indicates whether the CPU Interface is being told to STALL (ie - the BOOT or JTAG are currently using the management bus).

**Table 13. CPU Interface Address Space**

Address Range	Module	Usage
0x00000-0x000FF	CPU Mgmt	<p>There are no physical registers within this module. If a read to this address range occurs then {31'd0,CPU_I_STALL} will be returned. CPU_I_STALL indicates whether the CPU Interface is being told to STALL (ie - the BOOT or JTAG are currently using the management bus).</p> <p>A write will be ignored.</p>

The bus timing interface for read and writes are shown in next two figures. The minimum read frequency is 3 cycles and 2 for writes.

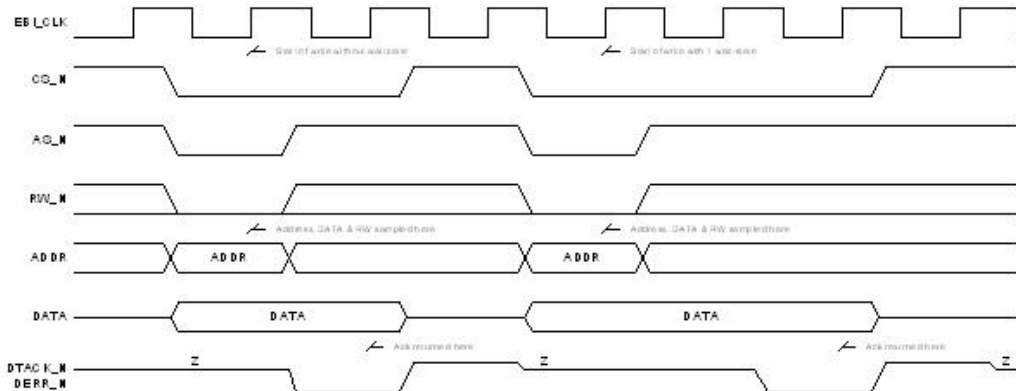

**Figure 17. CPU Interface Read Cycles**

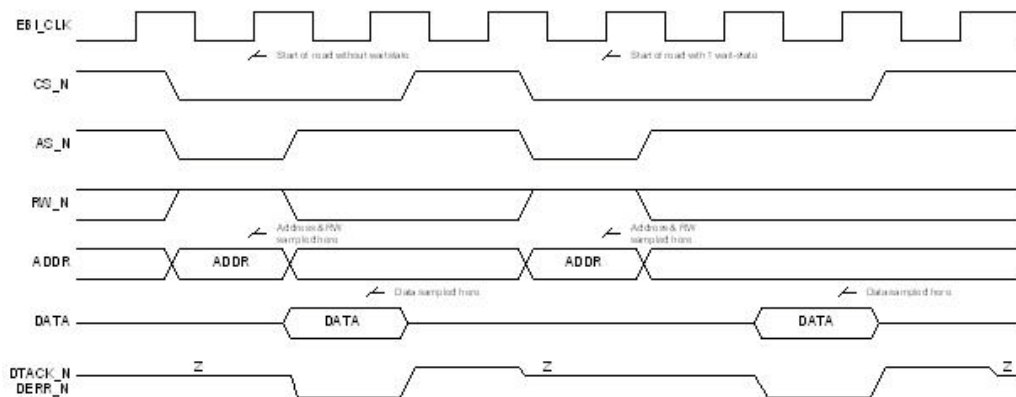

**Figure 18. CPU Interface Write Cycles**



### 3.5.4 SPI Interface (EEPROM)

There are three supported instructions which are always aligned to 32b. They are listed here and shown in

- WRITE(8b) - the write command will be followed by two arguments: 24b (last 2b ignored) address and 32b data - 64b in total
- WAIT(8b) - the wait command will be followed by 1 argument: 24b cycles to wait. Cycles are expressed in terms of the SPI clock, which is derived from the CPU clock (See Table 40). - 32b total
- DONE (8b) - EEPROM sequence is finished. Followed by RSVD (24b).

**Table 14. SPI write Sequence**

0	Dummy Byte (required for 2B addressing only).	WRITE
1	CMD = Write	
2	ADDR (MSB)	
3	ADDR	
4	ADDR (LSB)	
5	DATA (MSB)	
6	DATA	
7	DATA	
8	DATA (LSB)	WAIT
9	CMD = DELAY	
10	SPI_CLKS (MSB)	
11	SPI_CLKS	DONE
12	SPI_CLKS (LSB)	
13	FF	
14	FF	
15	FF	DONE
16	FF	

#### 3.5.4.1 SPI (Serial Peripheral Interface) Controller

A Serial peripheral Interface is needed to access bootstrap code from an off chip ROM.

- The SPI interface has the following constraints
  - Natively supports 3 byte addressing
  - 2-Byte addressing may be used by shifting all data up by 1 byte
- Support of one Chip Select
  - The EEPROM size is restricted to 64Kb - 2Mb - this is sufficient for about 30k instructions in a 2Mb part.
- Support of one Mode 0 (CPOL=0,CPHA=0 - transmit data on the falling edge of the SPICLK and receive data on the rising edge of the SPICLK signal) device (only one CS required)
- Support frequency of operation up to 40 MHz
- Interoperability note: The SPI works with following parts:



- ST FLASH and EEPROM
- ATMEL FLASH
- Fairchild EEPROM
- AKM EEPROM
- MicroChip EEPROM

**Table 15. SPI External Interface Pin List**

Signal Name	Signal Direction	Signal Description
SPI_SO	OUT	Serial Data Output (MOSI, Master-Out- Slave-In, since FM2112 is master). Connect to EEPROM serial data input
SPI_CS_N	OUT	SPI Chip Select (Active Low)
SPI_SCK	OUT	CLOCK for SPI interafce.
SPI_SI	IN	Serial Data Input (MISO, Master-In-Slave-Out, since FM2112 is master). Connect to EEPROM serial data output.

A SPI transaction is shown in [Figure 19](#) and described below:

- Activate SPI\_CS\_N and assert first data bit
- On the negative edge the clock, send the following bit stream - MSB first
  - Send instruction - 8'h3 (I[7:0])
  - Send 3 bytes of address (A[23:0])
- On the positive edge of the clock, receive each bit of data. This will continue until BOOT FSM asserts
- De-activate SPI\_CS\_N, Tri-state SPI\_SO.

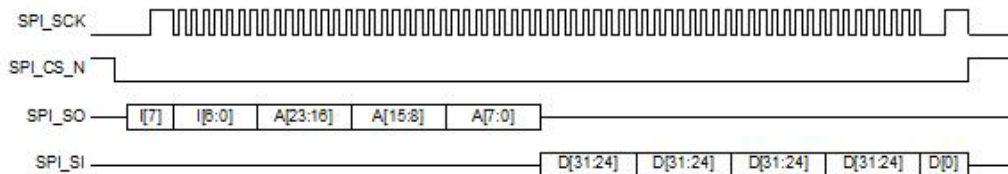

**Figure 19. SPI Timing Diagram**

### 3.5.5 LED Interface

The LED interface consists of 4 signals, CLK, DATA0, DATA1, DATA2, and ENABLE, which transmits 3 bits of status data for the LED per port over the time multiplexed data pins. The 3 bits of status of ports 0-8 are placed onto Data0 and the 3 bits of status on ports 9-16 are placed onto Data1 and the 3 bits of status of ports 17-24 are placed onto Data2.

There are two modes of operation.

Mode=0: This mode selects operations compatible to devices such as the SGS Thompson M5450 LED display drive type device. Data polarity is non-inverted.



Mode=1: This mode selects operations compatible with a standard octal shift register such as (74HC595). Data polarity is inverted.

The only difference between the 2 modes is the polarity of the data. Both will cycle through a continuous 36b cycle pattern. The data for each LED is placed serially on the appropriate data line and clocked out by LED\_CLK. See Table 16 for details on the sequence.

### 3.5.5.1 LED Clock Rate

This section provides information for setting the LED freq bits.

Setting these two bits to 0x0 will cause the CLK\_LED to be CPU\_CLK rate divided by 4. This setting is there mainly for simulation purposes and is not useful for device operation. The LED freq bits may be set to values between 0x1 to 0x7F, corresponding to an LED divisor of 1 to 127. For those settings the LED clock rate will be the CPU clock divided by (2^15 \* divisor).

2^15 is about 33,000, so for a CPU clock of 33MHz, the LED clock would be divided down to 1KHz with no other factor involved. If the LED freq bits are set to 0x02, one would get 500Hz, or a period of 2 ms. Recall that each LED is signaled at 1/36th of this rate (the LED frame rate - see the LED sequence table and LED timing diagram). This would give a rate of about 14 Hz for each LED, which is appropriate because the human eye will be able to detect the blinking LED state at that rate.

Table 16. Port LED Sequence

Cycle	LED_Data0	LED_Data1	LED_Data2	Description
1	Start Bit	Start Bit	Start Bit	Used to start the 48b series. Will always be a logical 1
2:3	Pad Bits	Pad Bits	Pad Bits	Used as fillers in the data stream to extend the length to the required 36b frame length. These bits will always be logical 0.
4:27	LED Data Bits Port1 bits 0,1,2 ... Port8 bits 0,1,2	LED Data Bits Port9 bits 0,1,2 ... Port16 bits 0,1,2	LED Data Bits Port17 bits 0,1,2 ... Port24 bits 0,1,2	Actual data to be transmitted
28:30	Port0 bits 0,1,2	Pad bits	Pad bits	
34:36	Pad Bits	Pad Bits	Pad Bits	Enable will be asserted synchronously with bit 36

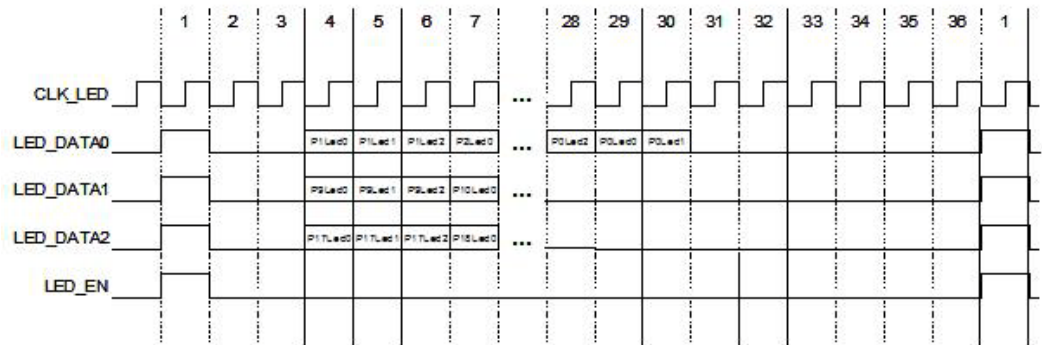

**Figure 20.** Serial LED Timing Diagram

Below is the encoding of the 3 bits per port:

- Port LED0 (Red)
  - Off - Port has no link synch or remote fault error
  - On - Port has a link synch error or no signal
  - Blinking - Port has a remote fault
- RX LED1 (Green)
  - Off - Port is not enabled
  - On - Port has link and is enabled
  - Blinking - Port is receiving data (rate will be controllable by a programmable decimated clock and fixed hysteresis value which when latches indicates that traffic has been received)
- TX LED2 (Green)
  - Off - Port is not transmitting data
  - Blinking - Port is transmitting data (rate will be controllable by a programmable decimated clock and some fixed hysteresis value which when latches indicates that traffic has been transmitted).

This interface clock is a multiple of CLK\_CPUI and CLK\_LED.

### 3.5.6 JTAG

The JTAG controller is compliant to the IEEE 1149.1-2001 specification. The JTAG provides basic external chip debug features,

- Access to an identification register.
- Access to the boundary scan.
- Access to the internal scan chains.
- Ability to Clamp and HighZ all outputs (except SerDes).

The maximum frequency of operation is 40MHZ.

The Supported operations of these registers are:

- Load IR (instruction register)



- Capture - initializes/captures/freezes value of register
- Shift - serially shifts in/out value into/out of register.
- Update - validates the contents of the register. Ie. Logic can now use the new value for its internal operation.

The JTAG reset domain is separate and independent from the chip reset domain.

### 3.5.6.1 Tap Controller

The tap controller is a finite state machine of 16 states controlled by the 5 pin JTAG interface. It is defined by IEEE 1149.1-2001.

### 3.5.6.2 Instruction Register

Supported JTAG Instructions

Table 17. Supported JTAG Instructions

Instruction	Code (6b)	Description
IDCODE	x01	Selects the identification register.
SAMPLE/PRELOAD	x02	Select the boundary scan register. Sample input pins to input boundary scan register, preload the output boundary scan register.
EXTEST	x03	Select the boundary scan register. Output boundary scan register cells drive the covered output pins. Input boundary cell registers sample the input pins.
HIGHZ	x06	Selects the bypass register and sets all covered output pins to high impedance.
CLAMP	x07	Forces a known value on the outputs, but uses the bypass register to shorten scan length.
BYPASS	x3F	Selects the bypass register.

### 3.5.6.3 Bypass Register

The bypass register is a 1 bit register that connects between TDI and TDO. When the bypass register is selected by the instruction, the data driven on the TDI input pin is shifted out the TDO interface one cycle later.

### 3.5.6.4 TAG Scan Chain

The boundary scan register is a 162-bit deep shift register. Refer to the BSDL description file for pin assignment.

Table 18. JTAG ID Register

Bit	Description	Value
31:28	Silicon Version Number	0x00 (pre-A5)
		0x01 (A5 and later)

**Table 18. JTAG ID Register (Continued)**

27:12	Manufacturer part number	0xae18
1:11	Manufacturer ID	0x215
0	Mandatory JTAG field	b1

## 3.6 Clocks

### 3.6.1 SerDes Clocks, RCK[A:B][1:4]P/N

The SerDes reference clocks are externally provided, low jitter, differential CMOS/CML clocks in the range of 100MHz to 400MHz, representing 1/10th the serial data rate. The requirements for these inputs are given in [Table 19](#).

**Table 19. Reference Clock Requirements**

Symbol	Description	Min	Typ	Max	Units
$V_{IL-RC}$	Low-level CML/CMOS input voltage	0		$V_{DD}-0.5$	V
$V_{IH-RC}$	High-level CML/CMOS input voltage	0	$V_{DD}$		V
	Clock frequency range	100		400	MHz
	Duty cycle	40	50	60	%
	Skew between + and - inputs of a single reference clock			.05	RCUI
$J_{CLK-REF}$	Input jitter (peak to peak)			0.1	UI <sup>1</sup>
$T_{RRef}, T_{FRef}$	Rise/Fall time of differential inputs		0.2	0.25	RCUI <sup>2</sup>

Notes:

- 1) UI refers to the Bit Time period
- 2) RCUI refers to the Reference Clock period

### 3.6.2 CPU Interface Clock

The clock source for the CPU interface on the FM2112 must meet the following requirements:

- 3.3V CMOS drive
- Maximum frequency of 100 MHz.

### 3.6.3 JTAG Clock

The FM2112 supports JTAG. The clock source must meet the LVTTL specification and:

- Duty cycle distortion of 40/60%, maximum
- Maximum frequency of 40 MHz

### 3.6.4 Frame Handler Clock

The frame handler clock controls the rate at which frame headers are processed in the frame handler block. Frame headers are processed one header per clock cycle, so if the aggregated 24-port frame throughput is desired to be 300 million frames per second, the frame handler clock must be set at 300 MHz. The aggregate frame rate for all ports in frames per second (FPS) should never exceed the frame handler clock speed in Herz (Hz) or unpredictable behavior will result. The frame handler clock is generated by an internal PLL using the FH\_PLL\_REFCLK clock input pin as its input. The relationship between the input frequency and the PLL output frequency to the frame handler is controlled by parameters input in the PLL\_FH\_CTRL register (See [Table 43](#)). A simplified schematic of the PLL circuit is shown that will clarify the meaning of the input parameters.

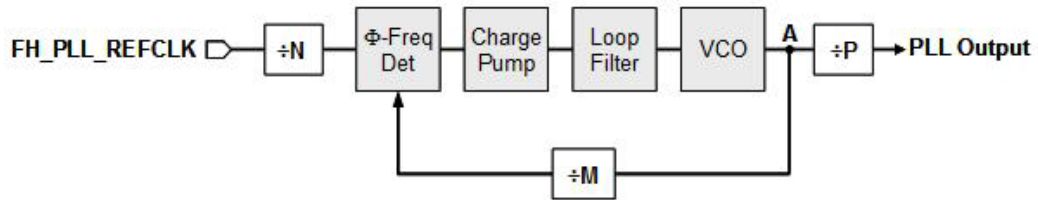

**Figure 21.** Frame Handler Clock Generation

The resulting equation governing the PLL output is:

$$PLL\_OUT = FH\_REFCLK \times M/NP$$

Where:

- N ==> 1 to 16
- M ==> 4 to 128
- 150 MHz < F<sub>VCO</sub> (point A) < 650 MHz
- 12.5 MHz < PLL output < 360 MHz
- 1.2 MHz < FH\_PLL\_REFCLK < 70 MHz

*Note:* See [Table 44](#) for examples of N, M, and P settings.





## 4.0 Electrical Specifications

The following tables provide recommended operating conditions for the FM2112:

### 4.1 Absolute Maximum Ratings

**Table 20. Absolute Maximum Ratings**

Parameter	Symbol	Min	Max	Units
Core Voltage	V <sub>DD</sub>	-0.3	2	Volts
SerDes Supply Voltage	V <sub>DDX</sub>	-0.3	2	Volts
SerDes Bias Voltage	V <sub>DDA</sub>	-0.3	2	Volts
Transmitter Termination Voltage	V <sub>TT</sub>	-0.3	2	Volts
LVTTTL Power Supply	V <sub>DD33</sub>	-0.3	3.9	Volts
PLL Analog power supply	V <sub>DDA33</sub>	-0.3	3.9	Volts
Case Temp under bias		-	+130	°C
Storage Temp		-65	+150	°C
ESD		-2000	+2000	Volts

### 4.2 Recommended Operating Conditions

**Table 21. Recommended Operating Conditions**

Parameter	Symbol	Min	Typ	Max	Units
Core Voltage	V <sub>DD</sub>	1.14	1.2	1.26	Volts
SerDes Supply Voltage	V <sub>DDX</sub>	1.14	1.2	1.26	Volts <sup>1,3</sup>
		0.95	1.0	1.1	Volts <sup>2,3</sup>
SerDes Bias Voltage	V <sub>DDA</sub>	1.14	1.2	1.26	Volts
		0.95	1.0	1.1	Volts
LVTTTL Power Supply	V <sub>DD33</sub>	3.14	3.3	3.47	Volts
PLL Analog power supply	V <sub>DDA33</sub>	3.14	3.3	3.47	Volts
Transmitter Termination Voltage	V <sub>TT</sub>	V <sub>DD</sub>	1.5	1.8	Volts
Operating Temp (Case)					
Commercial		0		+85	°C
Extended		0		+105	°C
Industrial		-40		+115	°C

- (1) Connect a 1.2KΩ resistor from RREF to V<sub>DDX</sub> for 1.2V operation
- (2) Connect a 1.0KΩ resistor from RREF to V<sub>DDX</sub> for 1.0V operation.



(3) Operating with VDDX = 1.0V results in less power dissipation, but operating with VDDX = 1.2V may be desired to avoid implementation of another supply voltage.

Use caution if doing this as the proper filtering must be implemented. See the Design Guide and/or contact Intel® for details.

**Table 22. DC Characteristics of 4mA LVTTTL Outputs**

Parameter	Symbol	Test Conditions	Min	Typ	Max	Units
HIGH Force Tri-State output leakage	I <sub>OZH</sub>	V <sub>DD</sub> = Max V <sub>O</sub> =V <sub>DD</sub>	-1	-	+1	µA
LOW Force Tri-State output leakage	I <sub>OZL</sub>	V <sub>DD</sub> =Max V <sub>O</sub> =GND	-1	-	+1	µA
Output HIGH Current	I <sub>ODH</sub>	V <sub>DD</sub> =1.2 V, V <sub>DD33</sub> =3.3 V, V <sub>O</sub> = 1.5 V	-	-17	-	mA
Output LOW Current	I <sub>ODL</sub>	V <sub>DD</sub> =1.2 V, V <sub>DD33</sub> =3.3 V, V <sub>O</sub> = 1.5 V	-	20	-	mA
Output HIGH Voltage	V <sub>OH</sub>	V <sub>DD</sub> = Min V <sub>DD33</sub> =Min I <sub>OH</sub> = -0.4 mA	V <sub>DD33</sub> - 0.2	-	-	V
Output HIGH Voltage	V <sub>OH</sub>	V <sub>DD</sub> = Min V <sub>DD33</sub> =Min I <sub>OH</sub> = -4.0 mA	V <sub>DD33</sub> - 0.5	-	-	V
Output LOW Voltage	V <sub>OL</sub>	V <sub>DD</sub> = Min V <sub>DD33</sub> =Min I <sub>OL</sub> = -0.4 mA	-	-	0.2	V
Output LOW Voltage	V <sub>OL</sub>	V <sub>DD</sub> = Min V <sub>DD33</sub> =Min I <sub>OL</sub> = -4.0 mA	-	0.2	0.4	V
Short Circuit Current	I <sub>OS</sub>	V <sub>DD</sub> =MAX V <sub>O</sub> =GND			-32	mA
Power Supply Quiescent Current	I <sub>AA</sub>	V <sub>DD</sub> = Max V <sub>DD33</sub> =Max			74	µA
Power Supply Quiescent Current	I <sub>AA</sub>	Tri-stated			-1	µA

**Table 23. DC Characteristics of 8mA LVTTTL Outputs**

Parameter	Symbol	Test Conditions	Min	Typ	Max	Units
HIGH Force Tri-State output leakage	I <sub>OZH</sub>	V <sub>DD</sub> = Max V <sub>O</sub> =V <sub>DD</sub>	-1	-	+1	µA
LOW Force Tri-State output leakage	I <sub>OZL</sub>	V <sub>DD</sub> =Max V <sub>O</sub> =GND	-1	-	+1	µA
Output HIGH Current	I <sub>ODH</sub>	V <sub>DD</sub> =1.2 V, V <sub>DD33</sub> =3.3 V, V <sub>O</sub> = 1.5 V	-	-35	-	mA
Output LOW Current	I <sub>ODL</sub>	V <sub>DD</sub> =1.2 V, V <sub>DD33</sub> =3.3 V, V <sub>O</sub> = 1.5 V	-	-40	-	mA
Output HIGH Voltage	V <sub>OH</sub>	V <sub>DD</sub> = Min V <sub>DD33</sub> =Min I <sub>OH</sub> = -0.4 mA	V <sub>DD33</sub> - 0.2	-	-	V

**Table 23. DC Characteristics of 8mA LVTTTL Outputs (Continued)**

Output HIGH Voltage	$V_{OH}$	$V_{DD} = \text{Min}$ $V_{DD33} = \text{Min}$ $I_{OH} = -4.0 \text{ mA}$	$V_{DD33} - 0.5$	-	-	V
Output LOW Voltage	$V_{OL}$	$V_{DD} = \text{Min}$ $V_{DD33} = \text{Min}$ $I_{OL} = -0.4 \text{ mA}$	-	-	0.2	V
Output LOW Voltage	$V_{OL}$	$V_{DD} = \text{Min}$ $V_{DD33} = \text{Min}$ $I_{OL} = -4.0 \text{ mA}$	-	0.2	0.4	V
Short Circuit Current	$I_{OS}$	$V_{DD} = \text{MAX}$ $V_o = \text{GND}$			-64	mA
Power Supply Quiescent Current	$I_{AA}$	$V_{DD} = \text{Max}$ $V_{DD33} = \text{Max}$			74	$\mu\text{A}$
Power Supply Quiescent Current	$I_{AA}$	Tri-stated			-1	$\mu\text{A}$

**Table 24. DC Characteristics of LVTTTL Inputs**

Parameter	Symbol	Test Conditions	Min	Typ	Max	Units
Input HIGH Level (Input and I/O pins)	$V_{IH}$	Guaranteed Logic HIGH Level	2	-	$V_{DD33} + 0.5$ (1)	V
Input LOW Level (Input and I/O pins)	$V_{IL}$	Guaranteed Logic LOW Level	-0.3	-	0.8	V
Input Hysteresis	$V_H$	it0		5		mV
Input Hysteresis	$V_H$	it2		200		mV
Input HIGH Current (Input pins)	$I_{IH}$	$V_{DD} = \text{Max}$ , $V_I = V_{IH}(\text{Max})$			+ -1	$\mu\text{A}$
Input HIGH Current (I/O pins)	$I_{IH}$	$V_{DD} = \text{Max}$ , $V_I = V_{DD33}$			+ -1	$\mu\text{A}$
Input LOW Current (Input pins)	$I_{IL}$	$V_{DD} = \text{Max}$ , $V_I = \text{GND}$			+ -1	$\mu\text{A}$
Input LOW Current (I/O pins)	$I_{IL}$	$V_{DD} = \text{Max}$ , $V_I = \text{GND}$			+ -1	$\mu\text{A}$
Clamp Diode Voltage	$V_{IK}$	$V_{DD} = \text{Min}$ , $I_{IN} = -18\text{mA}$		-0.7	-1.2	V
Quiescent Power Supply Current	$I_{DD33L}$	$V_{DD} = \text{Max}$ , $V_{DD33} = \text{Max}$ , $V_{IN} = \text{GND}$		0.1	10	$\mu\text{A}$
Quiescent Power Supply Current	$I_{DD33H}$	$V_{DD} = \text{Max}$ , $V_{DD33} = \text{Max}$ , $V_{IN} = V_{DD}$		0.1	10	$\mu\text{A}$

## 4.3 AC Timing Specifications

**Table 25. XAUI Transmitter Characteristics**

Symbol	Parameter	Min	Typ	Max	Units
$V_{SW}$	Output voltage (peak-to-peak, single-ended)	200 <sup>a</sup>	500	750 <sup>b</sup>	mV
$V_{DIFF-PP}$	Output voltage (peak-to-peak, differential)	400 <sup>a</sup>	1000	1500 <sup>b</sup>	mV
$V_{OL}$	Low-level output voltage		$V_{TT} - 1.5^*$ $V_{SW}$		



**Table 25. XAUI Transmitter Characteristics (Continued)**

$V_{OH}$	High-level output voltage		$V_{TT} - 0.5 * V_{SW}$		
$V_{TCM}$	Transmit common-mode voltage <sup>c</sup>		$V_{TT} - V_{SW}$		
$J_{TT}@1.25$ Gb/S	Transmitter Total Jitter (Peak-Peak) <sup>d</sup>			.24	UI
	Random jitter component (RJ)			.12	
	Deterministic jitter component (DJ)			.12	
$J_{TT}@3.125$ Gb/S	Transmitter Total Jitter (Peak-Peak) <sup>d</sup>			.35	UI
	Random jitter component (RJ)			.18	
	Deterministic jitter component (DJ)			.17	
$Z_{OSE}$	Single Ended Output Impedance	40	50	60	Ohms
$Z_D$	Differential Output Impedance	80	100	120	Ohms
$T_{TR}, T_{TF}$	Rise, fall times of differential outputs <sup>e</sup>	80		110	ps

- a. HiDrv bit set to 0, LoDrv bit set to 1 in SERDES\_CNTL\_2 register - see [Table 133](#), and Current Drive bits set to 1100 in SERDES\_CNTL\_1 register - see [Table 130](#).
- b.  $V_{TT} = 1.8V$ , HiDrv bit set to 1, LoDrv bit set to 0 in SERDES\_CNTL\_2 register - see [Table 133](#), and Current Drive bits set to 0011 in SERDES\_CNTL\_1 register - see [Table 130](#).
- c. AC coupled operation only.
- d. Based on CJPAT.
- e. 20% to 80%.

**Table 26. XAUI Receiver Characteristics**

Symbol	Parameter	Min	Typ	Max	Units
$V_{LOS}$	Low signal differential input threshold voltage	85			mV
$V_{IN}$	Differential input voltage, peak to peak	170		2000	mV
$V_{RCM}$	Common mode voltage		0.70		V
$T_{RR}, T_{RF}$	Rise, fall times of differential inputs			160	ps
$J_{RT} @ 1.25$ Gbps	Total jitter tolerance <sup>a</sup>			.71	UI
	Random jitter component (RJ)			.26	
	Deterministic jitter component (DJ)			.45	
$J_{TT} @ 3.25$ Gbps	Total jitter tolerance <sup>a</sup>			.65	UI
	Random jitter component (RJ)			.24	
	Deterministic jitter component (DJ)			.41	
$Z_{IN}$	Impedance, single-ended	40	50	60	W
$L_{DR}$	Differential return loss <sup>b</sup>	10			dB
$V_{RHP}$	Hot plug voltage (applied with power on or off) <sup>c</sup>	-.5		1.6	V

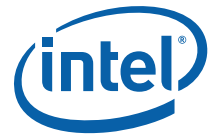

- a. CJPAT
- b. Frequency range of 100MHz to 1.875GHz
- c. Without damage to any signal pin

**4.3.1 CPU Interface, General Timing Requirements**

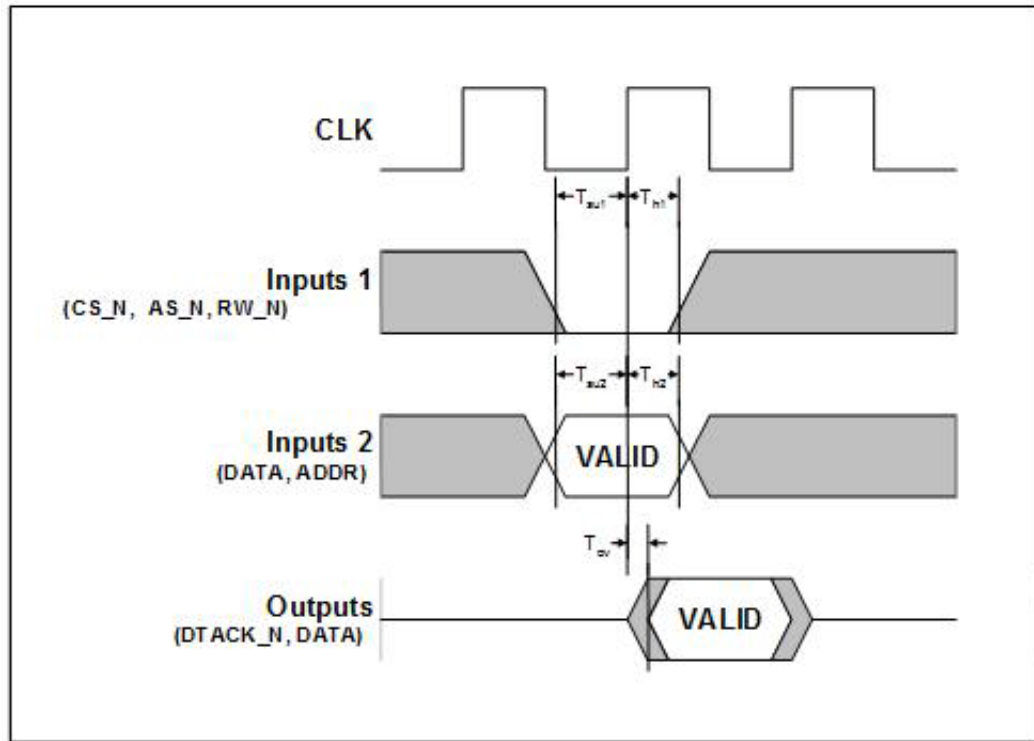

**Figure 22.** CPU Signal Timing

**Table 27.** CPU Interface Timing Constraints

Parameter	Symbol	Min	Typ	Max	Units	Test Conditions
Setup time for CS_N, AS_N, and RW_N, to rising edge of clock	Tsu1	3.0	-	-	ns	-
Hold time for CS_N, AS_N and RW_N, to rising edge of clock	Th1	0.5	-	-	ns	-
Setup time for ADDR and DATA(in) to rising edge of clock	Tsu2	3.0	-	-	ns	-



**Table 27. CPU Interface Timing Constraints (Continued)**

Hold time for ADDR and DATA(in) to rising edge of clock	Th2	0.5	-	-	ns	-
Output valid for DTACK_N and DATA(out) to rising edge of clock	Tov	0	-	4.5	ns	
Notes						
<ul style="list-style-type: none"><li>• DTACK_INV, RW_N_INV, SYNC_MODE are static signals. They must be stable before RESET_N is de-asserted.</li><li>• BUSIF_RESET and INTR are asynchronous signals.</li><li>• Typical latency to access an internal 32-bit register is in the range of 100-150ns</li></ul>						

### 4.3.2 JTAG Interface

The JTAG interface follows standard timing as defined in the IEEE 1149.1 Standard Test Access Port and Boundary-Scan Architecture, 2001.

*Note:* When not using the JTAG interface, either drive the TCK pin with an external clock, or drive the TRST\_N pin low. Conversely, when using the JTAG interface assert TRST\_N along with chip reset to ensure proper reset of the JTAG interface prior to use.



## 5.0 Register Definitions

This section provides information on the registers used in the FM2112. Although the registers are generally directly accessible, it is recommended that they be accessed through the Intel® API where related registers can be rationally configured as a group in the context of the application.

### 5.1 Register Conventions

Registers follow these conventions:

- All registers are 32 bits in length
- Tables may be more than 32 bits in length
- There are four types of register fields:
  - RW - Read / Write
  - RO - Read Only
  - CR - Clear on Read
  - PIN - Pin
- Registers are located on different reset domains and are reset to their default value only when their respective domain is reset. The reset domains are:
  - Global Reset Domain: Reset only when CHIP\_RESET\_N is asserted
  - Ethernet Port Logic Reset Domain: Reset when CHIP\_RESET\_N is asserted or the port reset is active (see PORT\_RESET register)
  - Frame Handler Reset Domain: Reset when frame handler reset is asserted (see SOFT\_RESET register)

*Note:* The entries in the MAC address (MA), VLAN Information Database (VID), Forwarding Information Database (FID), and Management Information Base (MIB) tables are larger than 32 bits, as follows: MA: 95 bits; VID: 64 bits; FID: 50 bits; MIB: 64 bits. the Intel® Ethernet Switch Family supports atomic access to these addresses. A read or write to the MAC address, VLAN, or Flooding ID tables, or the read of a MIB counter is atomic.

### 5.2 Register Map

*Note:* The statistics register map is detailed in section 5.7.

**Table 28. Global Register List**

Global Registers			
Name	Reset Domain	Description	Address
BOOT_STATUS	Global	Boot status	0x00000
SOFT_RESET	Global	Reset switch by software	0x00300
PORT_RESET	Global	Reset port by software	0x00318
CHIP_MODE	Global	Configures various chip-level modes	0x00301



**Table 28. Global Register List (Continued)**

CLK_MULT_1	Global	Clock multiples between the CPU interface, LED interface, and SPI interface	0x00302
FRAME_TIME_OUT	Global	Configures whether (and how) frames time out	0x00303
VPD	Global	Vital Product Data	0x00304
PLL_FH_CTRL	Global	Frame Handler PLL Control	0x00315
PLL_FH_STAT	Global	Frame Handler PLL Status	0x00316
PORT_CLK_SEL	Global	Selects between 2 CML clocks per port	0x00317

**Table 29. Switch Configuration Register List**

Switch Configuration Registers			
Name	Reset Domain	Description	Address
INTERRUPT_DETECT	Global	Detects an interrupt	0x00309
GLOBAL_EPL_INT_DETECT	Global	Detects an interrupt on a port	0x0030A
MGR_IP	Global	Chip interrupt pending	0x0030B
MGR_IM	Global	Chip interrupt mask	0x0030C
FRAME_CTRL_IP	Global	Frame control interrupt pending	0x0030D
FRAME_CTRL_IM	Global	Frame control interrupt mask	0x0030E
PERR_IP	Global	Parity error interrupt pending	0x00312
PERR_IM	Global	Parity error interrupt mask	0x00313
PERR_DEBUG	Global	Parity error debug	0x00314
TRIGGER_IP	FH	Trigger interrupt pending	0x640C6
TRIGGER_IM	FH	Trigger interrupt mask	0x640C7
PORT_MAC_SEC_IP	FH	MAC security interrupt pending	0x640C4
PORT_MAC_SEC_IM	FH	MAC security interrupt mask	0x640C5
PORT_VLAN_IP_1	FH	VLAN violation interrupt pending	0x640C0
PORT_VLAN_IM_1	FH	VLAN violation interrupt mask	0x640C1
PORT_VLAN_IP_2	FH	VLAN violation interrupt pending	0x640C2
PORT_VLAN_IM_2	FH	VLAN violation interrupt mask	0x640C3
SYS_CFG_1		General feature configuration	0x60001
SYS_CFG_2	Mgmt	General feature configuration in the asynchronous logic	0x58121
SYS_CFG_3	Global	Most significant bit of the CPU's MAC address (Port 0)	0x60002
SYS_CFG_4	Global	Least significant bit of the CPU's MAC address (Port 0)	0x60003
SYS_CFG_6	Global	Ether-type Trap	0x60004
SYS_CFG_7	Global	Age time	0x0030F



**Table 29. Switch Configuration Register List (Continued)**

PORT_CFG_1 [1..24]	Global	Security and VLAN settings	0x54000+i
PORT_CFG_2 [1..24]	Global	Port-based VLAN flood map	0x60060+i
HEADER_MASK [0..3]	Mgmt	128-bit mask of the Ethernet header	0x58110 0x58111 0x58112 0x58113

**Table 30. Logical CPU Interface Register List**

LCI Configuration Registers			
Name	Reset Domain	Description	Address
LCI_RX_FIFO	Mgmt	LCI RX FIFO	0x04000
LCI_TX_FIFO	Mgmt	LCI TX FIFO	0x04001
LCI_IP	Mgmt	LCI interrupt	0x04002
LCI_IM	Mgmt	LCI interrupt mask	0x04003
LCI_STATUS	Mgmt	LCI status	0x04004
LCI_CFG	Mgmt	LCI mode configuration	0x04005

**Table 31. Bridge Register List**

Bridge Registers			
Name	Reset Domain	Description	Address
MA_TABLE[0..16383]	Global	MAC address table	0x10000+i*4
VID_TABLE[0..4095]	Global	VLAN table	0x50000+i*2
FID_TABLE[0..4095]	Global	Spanning tree status per VLAN	0x52000+i*2
MA_TABLE_CFG	Mgmt	MAC address table configuration	0x58120
MA_TABLE_STATUS_1	Mgmt	Status of switch-modified entries in the MAC address Table	0x58000
MA_TABLE_STATUS_2	Mgmt	Bin full count and hash	0x58001
MA_TABLE_STATUS_3	Mgmt	No source address lookup count	0x03010
TRUNK_PORT_MAP [1..24]	FH	Indicates whether a port is in a Link Aggregation Group	0x63000+i
TRUNK_GROUP_1 [0..11]	FH	Link Aggregation Group entries 0-5	0x63020+i
TRUNK_GROUP_2 [0..11]	FH	Link Aggregation Group entries 6-11	0x63040+i
TRUNK_GROUP_3 [0..11]	FH	Length of Link Aggregation Group	0x63060+i
TRUNK_CANONICAL [1..24]	FH	Mapping to canonical port	0x60020+i
TRUNK_HASH_MASK	FH	byte mask for link aggregation hash function	0x61000
TRIGGER_CFG [0..15]	FH	Configures user programmable triggers	0x62020+i



**Table 31. Bridge Register List (Continued)**

TRIGGER_PRI [0..15]	FH	Switch priority to be in trigger	0x62040+i
TRIGGER_RX [0..15]	FH	Source port of trigger	0x62060+i
TRIGGER_TX [0..15]	FH	Destination port of trigger	0x62080+i

**Table 32. Congestion Management Register List**

Traffic Management Registers			
Name	Reset Domain	Description	Address
RX_PRI_MAP [0..24]	FH	Mapping of ingress priority to switch priority	0x60040+i
CM_PRI_MAP_1	FH	Mapping 1 of switch priority to PWD priority	0x64000
CM_PRI_MAP_2	FH	Mapping 2 of switch priority to PWD priority	0x64001
SCHED_PRI_MAP	FH	Mapping of switch priority to scheduling priority	0x60000
LFSR_CFG	FH	Random number configuration for PWD	0x64002
QUEUE_CFG_1 [0..24]	FH	RX and TX queue shared watermark for frame discard check	0x64020+i
QUEUE_CFG_2 [0..24]	FH	RX private watermark and configuration	0x64040+i
QUEUE_CFG_3	FH	Congestion management priority watermark selection	0x65000
QUEUE_CFG_4	FH	Congestion management low and high watermark	0x64003
STREAM_STATUS_1 [0..24]	FH	Occupancy for RX and TX queues	0x64060+i
STREAM_STATUS_2	FH	Occupancy of global stream memory	0x64008
EGRESS_SCHED_1	Mgmt	Egress scheduling configuration	0x02040
EGRESS_SCHED_2	Mgmt	Egress scheduling weights	0x02041
GLOBAL_PAUSE_WM [0..24]	FH	Watermarks for PAUSE based on stream memory occupancy	0x64080+i
RX_PAUSE_WM [0..24]	FH	Watermarks for PAUSE based on RX queue occupancy	0x640A0+i
SAF_MATRIX[0..24]	FH	Cut-through switching configuration	0x650C0+i
JITTER_CFG	Mgmt	Configures the TX jitter controller	0x020FC

**Table 33. Statistics and Counter Registers**

Statistics and Counter Registers			
Name	Reset Domain	Description	Address
STATS_CFG		Enable/Disable counter groups	0x66200
STATS_DROP_COUNT		Counts event rate related counter drops	0x66202
GROUP 1 COUNTERS		RX packet counters per type	0x70000
GROUP 2 COUNTERS		RX packet counters per size	0x70080

**Table 33. Statistics and Counter Registers (Continued)**

GROUP 3 COUNTERS		RX octet counters	0x700A0
GROUP 4 COUNTERS		RX packet counters per priority	0x70010
GROUP 5 COUNTERS		RX octet counters per priority	0x70120
GROUP 6 COUNTERS		RX packet counters per flow	0x70100
GROUP 7 COUNTERS		TX packet counters per type	0x70020
GROUP 8 COUNTERS		TX packet counters per size	0x700A8
GROUP 9 COUNTERS		TX octet counters	0x802C0
GROUP 10 COUNTERS		Congestion Management counters	0x66080
GROUP 11 COUNTERS		VLAN octet counters	0x66180
GROUP 12 COUNTERS		VLAN packet counters	0x66100
GROUP 13 COUNTERS		Trigger counters	0x660C0

**Table 34. Ethernet Port Logic Register List**

PHY Registers (EPL register addresses are $0x8000 + 0x400 * (N-1) + \text{Offset}$ , where N is the port number)			
Name	Reset Domain	Description	Offset
SERDES_CTRL_1	EPL	Per-lane DEQ and DTX	0x000
SERDES_CTRL_2	EPL	Lane, PLL, and mode control	0x001
SERDES_CTRL_3	EPL	Signal detect de-assertion count	0x002
SERDES_TEST_MODE	EPL	BIST test modes	0x003
SERDES_STATUS [1..24]	EPL	Counter for any interrupt in the SERDES	0x004
SERDES_IP	EPL	SERDES interrupt pending	0x005
SERDES_IM	EPL	SERDES interrupt mask	0x006
SERDES_BIST_ERR_CNT	EPL	BIST error count per lane.	0x008
PCS_CFG_1	EPL	PCS Control	0x009
PCS_CFG_2	EPL	Data value on local TX fault	0x00A
PCS_CFG_3	EPL	Data value on remote TX fault	0x00B
PCS_CFG_4	EPL	Data value on signal ordered set Sent	0x00C
PCS_CFG_5	EPL	Data value on signal ordered set received	0x00D
PCS_IP	EPL	PCS interrupt pending	0x00E
PCS_IM	EPL	PCS interrupt mask	0x00F
PACING_PRI_WM [0..7]	EPL	Watermarks per priority for inter-frame gap stretch	0x010+i
PACING_RATE	EPL	Pacing rate for inter-frame gap stretch	0x018
PACING_STATUS	EPL	Pacing status for inter-frame gap stretch	0x019
MAC_CFG_1	EPL	MAC configuration 1	0x01A
MAC_CFG_2	EPL	MAC configuration 2	0x01B
MAC_CFG_3	EPL	MAC configuration 3: Pause time value	0x01C
MAC_CFG_4	EPL	MAC Configuration 4: Pause re-send time	0x01D



**Table 34. Ethernet Port Logic Register List (Continued)**

MAC_CFG_5	EPL	MAC configuration 5: Most significant 16 bits of the MAC address, SA for Pause	0x01E
MAC_CFG_6	EPL	MAC configuration 6: Least significant 32 bits of the MAC address, SA for Pause	0x01F
TX_PRI_MAP_1	EPL	Switch to egress 1	0x020
TX_PRI_MAP_2	EPL	Switch to egress 2	0x021
MAC_STATUS	EPL	Idle status	0x022
MAC_IP	EPL	Interrupt pending	0x023
MAC_IM	EPL	Interrupt mask	0x024
EPL_INT_DETECT	EPL	Interrupt detect for the Ethernet Port Logic	0x02B
EPL_LED_STATUS	EPL	LED status bits	0x02A
STAT_EPL_ERROR1	EPL	Error count	0x025
STAT_EPL_ERROR2	EPL	Error count	0x028
STAT_TX_CRC	EPL	BAD CRC transmitted count	0x27
STAT_TX_PAUSE	EPL	Pause transmitted count	0x26
STAT_RX_JABBER	EPL	Received oversized with bad CRC	0x29
STAT_TX_BYTECOUNT	EPL	Transmit byte count	0x2C

**Table 35. Scan Chain Access Register List**

Global Registers			
Name	Ref	Description	Address
SCAN_FREQ_MULT		Boot status	0x00100
SCAN_CTRL		Reset switch by software	0x00101
SCAN_SEL		Reset port by software	0x00102
SCAN_DATA_IN		Configures various chip level modes	0x00103
SCAN_DATA_OUT		Clock multiples between CPU and LED and SPI	0x00104

## 5.3 Global Registers

### 5.3.1 Global Register Tables

**Table 36. BOOT\_STATUS**

Name	Bit	Description	Type	Default
Memory Initialization	2	Indicates that the boot FSM has not completed this step yet.	RO	0
EEPROM Reading	1	Indicates that the boot FSM has not completed this step yet.	RO	0
Boot Running	0	The boot process is actually running (1) or completed (0). The CPU shall not attempt to read/write any register until this bit is 0.	RO	0
RSVD	31:3	Reserved. Set to 0.	RV	0

**Table 37. SOFT\_RESET**

Name	Bit	Description	Type	Default
Frame Handler Reset	1	The Frame Handler block goes into reset on CHIP_RESET_N and stays in reset until it is explicitly taken out of reset. Note: The bit enables the frame handler PLL to be initialized while the block is in reset.	RW	1
Core Reset	0	Reset of Switch Element and Frame Processor (except the Frame Handler) Note: In this mode, it is not necessary to power down the SERDES, however all EPLs should be disabled before running Internal Reset. This bit will self-reset to 0 after 16 clocks. The software must wait at least 16 clock cycles after writing this bit to 1 before attempting to access any other registers.	RW	0
RSVD	31:2	Reserved. Set to 0.	RV	0

*Note:* The management block is reset off of the CPU interface Reset.

It includes LED, SPI, LCI, and other related blocks and interfaces.

The following Reset domains contain the “or” of the following signals:

EPL(n): PORT\_RESET[n] | ~CHIP\_RST\_N  
 Switch Element and Frame Processor: Internal Reset | ~CHIP\_RST\_N  
 Management: ~CHIP\_RST\_N  
 CPU Interface: ~CPU\_INT\_RST\_N | ~CHP\_RST\_N  
 JTAG: ~TRST\_N

TRST\_N and CHIP\_RST\_N are independent domains.

**Table 38. PORT\_RESET**

Name	Bit	Description	Type	Default
Port Reset	24:1	Reset Ethernet port logic per port. The bit number corresponds to the port number.	RW	1
RSVD	31:25, 0	Reserved. Set to 0.	RV	1

*Notes:*

- To use a port, the Port Reset bit must be cleared.
- Any management access to a port in Reset will be trapped
- On a Write, the write data will have no effect
- On a Read, a read data word of zero will be sourced to the management block
- There is no way to inspect the EPL register states of a port in reset through management. However, a port may be disabled, and its state may be debugged while it has an operational clock.
- If all ports on a common clock are in Reset, it is safe to disable the port clock.



**Table 39. CHIP\_MODE**

Name	Bit	Description	Type	Default
Bypass PLL	13	Bypass the PLL in the Frame Handler and take the clock from off-chip. Note: this is not the same as the PLL_FH_CTRL[bypass] bit. This bit must be reset to 0 after the bootstrap is completed and FH PLL has been initialized and locked for the device to work properly. This bit should be held at 1 for scan test of the Frame Handler.	RW	1
Exec Mem Init	10	x1 – Execute memory initialization phase of BOOT FSM. x0 – Do not execute memory initialization phase of BOOT FSM	RW	0
Exec EEPROM	9	x1 – Execute EEPROM phase of BOOT FSM. x0 – Do not execute EEPROM phase of BOOT FSM	RW	0
Start BOOT FSM	8	x1 – Starts the BOOT FSM using the content of CHIP_MOD[9:11] to define which step is executed or skipped. This is a self clear register once the BOOT FSM has completed the operation. x0 – Do not start the BOOT FSM.	RW	0
RSVD	7:4	Reserved. Set to 0.	RV	0
LED Mode	3	1 – Invert LED data on the LED interface. 0 – Do not invert LED data on the LED interface.	RW	0
LED Enable	2	1 – Present LED signals on the LED interface. 0 – Disable the generation of LED signals	RW	0
RSVD	1	Reserved. Set to 0.	RV	0
DFT Access	0	Grants access of the DFT functions to the control interfaces	RW	0
RSVD	31:14, 11:12	Reserved. Set to 0.	RV	0

**Table 40. CLK\_MULT\_1**

Name	Bit	Description	Type	Default
SPI Divider	15:8	The SPI EEPROM clock divider SPI clock = CPU Interface clock / (2*(SPI Div+1)) Default value gives CPU clock speed divisor of 52.	RW	0x19
LED Divider	7:0	LED clock divisor 0x0: LED clock = CPU_CLK / 4  0x1...0x7F: LED Clock = CPU_CLK/(2 <sup>15</sup> * LED Div)	RW	0x00
RSVD	31:16	Reserved. Set to 0.	RV	0



Table 41. FRAME\_TIME\_OUT

Name	Bit	Description	Type	Default
Frame Timer	27:0	Timer to determine whether a frame has been in the switch element for too long. Once the timer is reached the frame will be discarded. x0 – turns off the feature x000001 – x3FFFFFF – Timer in increments of $2^{10}$ * CPU Interface cycle time. x000001 – 15 uS x00F4240 – 15 seconds xFFFFFFFF – 1 hour Note: The values listed here by way of example assume a 66 MHz CPU Interface.	RW	0x0
RSVD	31:28	Reserved. Set to 0.	RV	0

Table 42. VITAL\_PRODUCT\_DATA

Name	Bit	Description	Type	Default
Version	31:28	Version, pre A5 silicon Version, A5 silicon	RO	0x0 0x1
Part Number	27:12	Part Number – Intel® specific	RO	0xAE18
JTAG ID	11:1	JEDEC Manufacturer's ID for Intel® (4 bytes of continuation code and ID of 7'h15)	RO	0x215
CONST	0	1 bit constant alignment field	RO	1

Table 43. PLL\_FH\_CTRL

Name	Bit	Description	Type	Default
Out Enable	15	Allows the PLL output to be driven out of the chip for debug purposes	RW	0
N Divider	14:11	N Parameter. See section 3.6.3. . (Note: setting this parameter to 0 will cause the divider to be 16.)	RW	4
M Divider	10:4	M Parameter. See section 3.6.3. . (Note: setting this parameter to 0 will cause the multiplier to be 128.)	RW	20
P Divider	3:2	P Parameter. See section 3.6.3.  0 = divide by 1 1 = divide by 2 2 = divide by 4 3 = divide by 8	RW	0
Disable	1	Power down the PLL	RW	1
Bypass	0	Bypass FH_PLL_REFCLK through to the output of the PLL. FH_PLL_REFCLK is the input to the PLL.	RW	0
RSVD	31:16	Reserved. Set to 0.	RV	0



**Table 44. PLL Configuration Examples**

FH_REFCLK	M	N	P	PLL_OUT
33MHZ	24	3	0	264MHZ
33MHZ	27	3	0	297MHZ
33MHZ	30	3	0	330MHZ
33MHZ	31	3	0	341MHZ
33MHZ	33	3	0	363MHZ
66MHZ	20	4	0	330MHZ
66MHZ	22	4	1	363MHZ

**Table 45. PLL\_FH\_STAT**

Name	Bit	Description	Type	Default
Lock	0	PLL has achieved lock	RO	0
RSVD	31:1	Reserved. Set to 0.	RV	0

**Table 46. PORT\_CLK\_SEL**

Name	Bit	Description	Type	Default
RefClkSel (n)	(n)	Selects one of the two low-jitter RefClks for port (n). b0 selects RCK[i][A] b1 selects RCK[i][B] The index [i] is the group number of the clocks available at port (n).	RW	0
RSVD	31:25,0	Reserved. Set to 0.	RV	0

*Note:* The physical clock inputs to the chip group the ports into 4 groups of 6 ports; each group shares the same two clock references. These groups are based on proximity. The following table specifies which ports are in which clock group:

GROUP	PORTS	REFCLK
1	1,3,5,7,9,11	RCK[1][A] RCK[1][B]
2	2,4,6,8,10,12	RCK[2][A] RCK[2][B]
3	13,15,17,19,21,23	RCK[3][A] RCK[3][B]
4	14,16,18,20,22,24	RCK[4][A] RCK[4][B]





## 5.4 Switch Configuration

### 5.4.1 Critical Events

**Table 47. INTERRUPT\_DETECT**

Name	Bit	Description	Type	Default
PERR_INT	12	Parity error has been detected	RO	0
PORT_VLAN_INT_1	11	A VLAN egress boundary violation has occurred	RO	0
PORT_VLAN_INT_2	10	A VLAN ingress boundary violation has occurred	RO	0
PORT_MAC_SEC_INT	9	A security violation has occurred	RO	0
EPL_INT_DETECT	8	An Ethernet port has raised an interrupt	RO	0
RSVD	7:6	Reserved. Set to 0.	RV	0
MGR_INT	5	An interrupt has occurred in the Manager unit	RO	0
FC_INT	4	An interrupt has occurred in the Frame control	RO	0
RSVD	3	Reserved. Set to 0.	RV	0
TRIGGER_INT	2	An Interrupt has occurred in the Triggers	RO	0
LCI_INT	1	An Interrupt has occurred in the Logical CPU Interface	RO	0
RSVD	31:13,0	Reserved. Set to 0.	RV	0

*Note:* All unmasked interrupts in the interrupt detect register are “or-d” together to form the bus interrupt: INT\_N.

**Table 48. GLOBAL\_EPL\_INT\_DETECT**

Name	Bit	Description	Type	Default
GLOBAL_INT_DET	24:1	Interrupt on Port[i] is indicated by bit[i]	RO	0
RSVD	0, 31:25	Reserved. Set to 0.	RV	0

**Table 49. MGR\_IP**

Name	Bit	Description	Type	Default
RSVD	6:5	Reserved. Set to 0.	RV	0
Boot Done	4	Boot complete	RO	0
EEPROM Error	3	Error on SPI interface	CR	0
RSVD	2:0	Reserved. Set to 0.	RV	0
RSVD	31:7	Reserved. Set to 0.	RV	0



**Table 50. MGR\_IM**

Name	Bit	Description	Type	Default
Mask Interrupts	6:0	For each interrupt: 1 – Mask Interrupt 0 – Do not mask interrupt Note: EEPROM interrupts default to active so the CPU can be called in if there is an EEPROM error, without having to write this register.	RW	x7F
RSVD	31:7	Reserved. Set to 0.	RV	0

**Table 51. FRAME\_CTRL\_IP**

Name	Bit	Description	Type	Default
Skip Learn	10	A learning event was skipped because there wasn't adequate time to complete the operation	CR	0
Skip source address lookup	9	A source address lookup was skipped because there wasn't adequate time to complete the operation (requires source address lookup mode=1 in MA_CFG_2)	CR	0
Frame Time Out	8	Frames have timed out from being in the fabric for too long.	CR	0
Parity Error	7	Indicate a parity error while processing a frame.	CR	0
CM Privilege drop	6	A frame was dropped because it would have exceeded the privileged watermark. This means the entire memory is full and is an equivalent condition to MACs overflowing.	CR	0
VID table parity error	5	A parity error has occurred in the VLAN ID table. Note: In the hardware the membership and spanning tree state are separated into two different tables. The parity information from both tables is combined in this interrupt.	CR	0
MAC address status buffer overflow	4	The 64-place status buffer overflowed and now the table is fatally out of synchronization with software	CR	0
MAC address full bin	3	A MAC address bin is full	CR	0
MAC address new entry	2	A new entry has been learned in the MAC address table	CR	0
MAC address Aged entry	1	An address has been aged out of the MAC address table	CR	0
MAC address table parity error	0	A parity error has occurred in the MAC address table	CR	0
RSVD	31:11	Reserved. Set to 0.	RV	0

*Note:* The following interrupts actually occur in the switch element, but are reported in the FRAME\_CTRL\_IP register: Frame Time Out; Parity Error in the Scheduler

**Table 52. FRAME\_CTRL\_IM**

Name	Bit	Description	Type	Default
Mask Interrupts	10:0	For each interrupt: 1 – Mask Interrupt 0 – Do not mask interrupt	RW	x7FF
RSVD	31:11	Reserved. Set to 0.	RV	0

**Table 53. PERR\_IP**

Name	Bit	Description	Type	Default
Parity Error	15:12	A fatal parity error has occurred from one of three sources of parity errors. (If the watchdog is enabled it will reboot the chip.)	CR	0
Parity Error	11:4	A parity error occurred in one of eight sources. The switch removed one memory segment from the free pool to recover from this error. It is recommended to reboot the device.	CR	0
Parity Error	3:0	A parity error has occurred in one of four sources. The switch recovered from this error.	CR	0
RSVD	31:16	Reserved. Set to 0.	RV	0

**Table 54. PERR\_IM**

Name	Bit	Description	Type	Default
Mask Interrupts	15:0	For each interrupt: 1 – Mask Interrupt 0 – Do not mask interrupt Note: EEPROM interrupts default to active so the CPU can be called in if there is an EEPROM error, without having to write this register.	RW	xFFFF
RSVD	31:16	Reserved. Set to 0.	RV	0

**Table 55. PERR\_DEBUG**

Name	Bit	Description	Type	Default
Fatal Parity Error	23:16	Count of fatal parity errors	CR	0
Cumulative Parity Error	15:8	Count of cumulative parity errors	CR	0
Transient Parity Error	7:0	Count of transient parity errors	CR	0
RSVD	31:24	Reserved. Set to 0.	RV	0



**Table 56. PORT\_VLAN\_IP\_1**

Name	Bit	Description	Type	Default
VLAN egress BV (port n)	24:1 (port n)	A known unicast address couldn't be forwarded to its destination because the egress port was not in its VLAN membership group, and VLAN unicast tunnel is off, or the destination address is not locked.  This does not apply to standard VLAN flooding.  The bit number corresponds to the port number of the port of the frame's ingress.	CR	0
RSVD	31:25,0	Reserved. Set to 0.	RV	0

**Table 57. PORT\_VLAN\_IM\_1**

Name	Bit	Description	Type	Default
Mask Interrupts	24:1	For each interrupt: 1 – Mask Interrupt 0 – Do not mask interrupt	RW	0xFFFFFFFF
RSVD	31:25,0	Reserved. Set to 0.	RV	0

**Table 58. PORT\_VLAN\_IP\_2**

Name	Bit	Description	Type	Default
VLAN Ingress BV (port n)	24:1 (port n)	Source port not a member for that VLAN ID. The bit number corresponds to the port number of the port of the frame's ingress.	CR	0
RSVD	31:25,0	Reserved. Set to 0.	RV	0

**Table 59. PORT\_VLAN\_IM\_2**

Name	Bit	Description	Type	Default
Mask Interrupts	24:1	For each interrupt: 1 – Mask Interrupt 0 – Do not mask interrupt	RW	0xFFFFFFFF
RSVD	31:25,0	Reserved. Set to 0.	RV	0

**Table 60. PORT\_MAC\_SEC\_IP**

Name	Bit	Description	Type	Default
MAC Security violation (port n)	24:1 (port n)	A security violation occurred on this port. The bit number corresponds to the port number.	CR	0
RSVD	31:25,0	Reserved. Set to 0.	RV	0

**Table 61. PORT\_MAC\_SEC\_IM**

Name	Bit	Description	Type	Default
Mask Interrupts	24:1	For each interrupt: 1 – Mask Interrupt 0 – Do not mask interrupt	RW	FFFFFF
RSVD	31:25,0	Reserved. Set to 0.	RV	0

**Table 62. TRIGGER\_IP**

Name	Bit	Description	Type	Default
Trigger [n]	n (15:0)	An interrupt has occurred on Trigger [n]	CR	0
RSVD	31:16	Reserved. Set to 0.	RV	0

**Table 63. TRIGGER\_IM**

Name	Bit	Description	Type	Default
Mask Interrupts	15:0	For each interrupt: 1 – Mask Interrupt 0 – Do not mask interrupt	RW	FFFF
RSVD	31:16	Reserved. Set to 0.	RV	0

## 5.4.2 System Configuration

**Table 64. SYS\_CFG\_1**

Name	Bit	Description	Type	Default
Broadcast disable	15	x1 – Discard broadcast frames x0 – Treat broadcast frames normally (see SYS_CFG_1[Broadcast Control]) for further details.	RW	0
Flood control multicast	14	If a multicast address is unknown on destination address look-up, it will be flooded unless this bit is set.	RW	0
Flood control unicast	13	If a unicast address is unknown on destination address look-up, it will be flooded unless this bit is set.	RW	0
RSVD	12:11	Reserved. Set to 0.	RV	0
Drop Pause	10	This bit only has an effect when the Ethernet Port Logic is streaming pause into the switch element. x0 – Frames with the MAC control address 01-80-c2-00-00-01 are treated as ordinary multicast (pause pass-through). RxMcast counter is incremented. x1 – Frames with the MAC control address 01-80-c2-00-00-01 are discarded (normal Ethernet behavior). RxPause counter is incremented.	RW	1



**Table 64. SYS\_CFG\_1 (Continued)**

Remap ET SP15	9	1 – Remap any frame for which the Ether-type = the programmed Ether-type trap to switch priority 15 0 – Do not do this priority remapping. This only applies if the trap is enabled.	RW	0
Remap CPU SP15	8	1 – Remap any frame for which the destination address = the programmable CPU MAC address to switch priority 15. 0 – Do not do this priority remapping. This only applies if the trap is enabled.	RW	0
Remap IEEE SP15	7	1 – Remap any frame with IEEE reserved destination address, or IGMPv3 destination address to Switch Priority 15. 0 – Do not do this priority remapping. This only applies if the trap is enabled	RW	1
Broadcast control	6	1 – Send broadcast to the CPU port 0 – Do not send the broadcast to the CPU port A broadcast occurs when Destination address = xFFFFFFFF	RW	1
Trap 802.1x frames	5	1 – Trap frames with destination address = 0x0180C2000003. This may be used in connection with Ether-type trap set to 88-8E	RW	1
Trap IGMP v3 frames	4	1 – IGMPv3 configuration frames will be forwarded to the CPU destination address = 0x01005E000001. 0 – IGMPv3 configuration frames are treated as regular multicast frames	RW	1
Trap GARP frames	3	1 – GARP ports will be forwarded to the CPU 0 – GARP frames are treated as regular multicast frames Note: This includes both GMRP and GVRP. Destination address = 0x0180c2000020 and destination address = 0x0180C2000021	RW	1
Trap BPDU frames (Enable Spanning Tree)	2	1 – BPDU ports will be forwarded to the CPU. Destination address = 0x0180C2000000. 0 – BPDU frames are treated as regular multicast frames	RW	1
Trap LACP and Marker frames (Enable Link aggregation)	1	1 – LACP and Marker frames will be forwarded to the CPU. Destination address = 0x0180C2000002. 0 – LACP and Marker frames will be treated as regular multicast frames.	RW	1
Trap Other generic slow protocols	0	1 – Frames of all other IEEE reserved multicast addresses (not enumerated above) will be forwarded to the CPU. Destination address = 0x0180C20000xy: where x==0 & y > 3, x==1, or x==2 & y > 1 0 – Frames of all other IEEE reserved multicast addresses (not enumerated above) will be treated normally.	RW	1
RSVD	31:16	Reserved. Set to 0.	RV	0



Table 65. SYS\_CFG\_2

Name	Bit	Description	Type	Default
Multiple Spanning Trees	3	1 – There is one spanning tree per VLAN 0 – There is one spanning tree shared by all of the VLANs	RW	0
Enable 802.1q VLAN tagging	2	1 – Use the VLAN table, L2 packet look-up is by MAC address and VLAN. All frames have a VID association. (Either from tag that is already there on Ingress or by port association). <b>Note: VLAN #4095 is Reserved.</b> 0 – Ignore tags. The tag (or lack of a tag) of the outgoing frame is the same as when the frame Ingressed. There is no notion of a VID in this context. However, the port-based VLAN membership list is stored in the VID table, indexed by port instead of VID.	RW	0
VLAN multicast Tunnel	1	1 – Multicast bit mask is not “anded” with VLAN mask. In IVL mode, the FID address is made “zero” for multicast if the tunnel is on. 0 – Multicast bit mask is “anded” with VLAN mask as normal.	RW	0
VLAN unicast Tunnel	0	1 – Unicast bit mask is not “anded” with VLAN membership if the entry is locked in the table. Note: This feature is only efficient in shared learning mode.	RW	0
RSVD	31:4	Reserved. Set to 0.	RV	0

Table 66. SYS\_CFG\_3

Name	Bit	Description	Type	Default
CPU MAC address MSB	15:0	Top 16 bits of the CPU MAC address	RW	x0000
RSVD	31:16	Reserved. Set to 0.	RV	0

*Note:* If a frame has a destination address = CPU MAC address, then that packet is sent to the CPU regardless of VLAN association.

Table 67. SYS\_CFG\_4

Name	Bit	Description	Type	Default
CPU MAC address LSB	31:0	Bottom 32 bits of the CPU MAC address	RW	x00000000



**Table 68. SYS\_CFG\_6**

Name	Bit	Description	Type	Default
Ether-type Trap on	16	1 - Enable Ether-type trap 0 - Disable Ether-type trap	RW	0
Ether-type value	15:0	Value of 2 byte ether-type field to be trapped. Any packet with this field will be sent to the CPU instead of forwarded normally. Like IEEE group addresses, this trap takes precedence over VLAN and MAC security. Default is set to type for IEEE 802.1x.	RW	x888E
RSVD	31:17	Reserved. Set to 0.	RV	0

**Table 69. SYS\_CFG\_7**

Name	Bit	Description	Type	Default
Disable Aging	31	x1 - Do not age the table x0 - Age the table with the age time specified below.	RW	0x1
Age Time	30:0	MAC table entry age time, t, in terms of CPU clock periods. Table aging proceeds one entry every 2t periods. The 16K table requires 16K*t*2 periods to complete the aging process. Example: CPU clock 50 MHz (period = 20 ns) Timer set to 0x7530 (decimal 30,000) Entries are aged one per 1.2 ms (30,000*2*20 ns) Entire table aging process occurs in 19.2 sec.  Note: This is a best case calculation. Other activity on the bus takes precedence over aging requests, so actual age timing may be somewhat slower. 0x0 - RSVD	RW	0x7530





### 5.4.3 Per port Configuration

Table 70. PORT\_CFG\_1 [0..24]

Name	Bit	Description	Type	Default
Multiple VLAN Tagging	25	x1 – Treat the incoming frame as if it is untagged for the purpose of VLAN association and tagging. The frame is associated with the per port VLAN default. If the frame leaves the switch tagged in 802.1Q mode, it gets an additional VLAN tag. If the frame leaves the switch untagged in 802.1Q mode, then any original VLAN is preserved, but this tag is not added. Note: If set to 1, VLAN ingress port precedence (bit 19) must also be set to 1. x0 – Single tag only. All of the VLAN rules pertain to the traditional VLAN tag only.	RW	0
Remap Security SP15	24	x1 – Remap a security violation frame that is trapped and sent to the CPU to Switch Priority 15 x0 – Do not do this priority remapping	RW	0
Security CFG	23	x0 – Do not trap the frame that caused a security violation. In which case the frame is simply discarded. x1 –Trap the frame and send it to the CPU. Note: Security violations are never forwarded to non-CPU Ethernet ports.	RW	0
MAC security enable	22:21	x0 – No security checks x1 – Unknown source MAC address is considered a security violation x2 – Unknown source MAC address or a source MAC association with another port is a security violation. x3 - reserved Note: Port security is not VLAN aware.	RW	0
Learning Enable	20	1 – Source addresses from this port will be learned. 0 - Source addresses from this port will not be learned.	RW	1
VLAN ingress port precedence	19	0 – Tag untagged frames only 1 – Overwrite all frames with port default VID and internal switch priority. (Note that egress frame's priority is still subject to the regeneration bits in TX_PRI_MAP.)	RW	0
Filter ingress VLAN boundary violations	18	1 - If the source port does not match the VLAN membership, it is a VLAN boundary violation and the packet is dropped. 0 – Such packet is not dropped.	RW	0
Drop untagged frames	17	1 – Filter frames that do not Ingress with a VLAN tag. 0 – Accept frames that do not Ingress with a VLAN tag. Note: If the “Multiple VLAN Tagging” bit is set, then this filter will result in a discard if the incoming frame does not have its first level tag. That is, the ethertype does not equal VLAN. If Ethertype = VLAN but VLAN-ID = 0, the frame is considered untagged.	RW	0



**Table 70. PORT\_CFG\_1 [0..24] (Continued)**

Drop tagged frames	16	1 – Filter frames that ingress with a VLAN tag (Ethertype = VLAN) and (VLAN-ID > 0) 0 – Do not drop tagged frames.	RW	0
Default VLAN Priority	15:13	Default VLAN priority.	RW	x0
RSVD	12	Reserved. Set to 0.	RW	0
Default VID	11:0	Default VLAN ID for this port.	RW	x001
RSVD	31:26	Reserved. Set to 0.	RV	0

See Figure 9-4 of IEEE 802.3Q-2003 (page 85) for frame format of the 2 byte VLAN tag.

*Note:* The VLAN priority is associated with the frame logically, before any other priority based calculation, inclusive of priority mapping, RX priority counters, etc.

**Table 71. PORT\_CFG\_2 [0..24]**

Name	Bit	Description	Type	Default
Source Mask	24:0	A vector for each port i, a bit for each port j, 1 – Port i may send packets to port j. 0 – Port i may not send packets to port j. This feature is used to: Prevent multicast and broadcast traffic from going out the port it came in on, Cut loops in statically-configured networks, Prevent link aggregates from receiving multiple copies of multicast and broadcast traffic. This mask is always “anded” with the destination mask. It is not enabled, if the mask were set to all ones, it would have no effect. There is no need to have a default setting of bit i on port i = 0 to prevent loops. The reflect bit in the VLAN table automatically creates this effect.	RW	x1FFFFFF
RSVD	31:25	Reserved. Set to 0.	RV	0

*Note:* The Port Based VLAN registers are also viewed as a general port membership list. This is used for other features in the device besides legacy non-802.3q VLANs. The features are:

- Port-based VLAN
- Link Aggregation
- Preventing Loop back

*Note:* If ingress port frame reflection is enabled, and the per-VLAN frame reflection bit is set for the VLAN associated with a given frame, then a frame may egress its ingress port, if either:

- The frame is flooded for a DLF
- The egress port is the forwarding port as determined by the MAC table
- The frame is a broadcast frame



*Note:* There is no requirement for a static table entry. This rule supersedes PORT\_CFG\_2 [1..24]. x0 - a frame's egress port may not also be its ingress port.

#### 5.4.4 Non-IEEE 802.3 Header Info

Non IEEE-compliant header support comes from two features:

- The location of the 16-byte header can be offset in the global per port settings from the start of packet by any arbitrary byte amount up to 256bytes from the start of the header.
- A bit mask can be applied to any bits in the 16-byte header to generalize the standard source, destination, and type/VLAN fields that would normally exist.

**Table 72. HEADER\_MASK [0..3]**

Name	Bit	Description	Type	Default
SWM	31:0	Bit mask for sliding window mask.	RW	xFFFFFFFF

*Note:* These registers do not modify the packet itself.

#### 5.4.5 Logical CPU Interface Registers

**Table 73. LCI\_CFG**

Name	Bit	Description	Type	Default
RSVD	16:11	Reserved. Set to 0.	RV	0
RSVD	10:5	Reserved. Set to 0.	RV	0
Host Padding	4	1 - Padding for frames sent from the switch to the host is to 64 bit boundaries. 0 - Padding for frames sent from the switch to the host is to 32 bit boundaries. Note: Padding is not required when sending frames from the host to the switch. This feature is to increase compatibility with off-chip DMA engines.	RW	0
Endianess	3	0 - CPU is little Endian. 1 - CPU is big Endian.	RW	0
Tx Compute CRC	2	1- Computes the CRC and overwrites the last 4 bytes of the packet with the new CRC. 0 - Does not compute the CRC and relies on what the CPU has written in the CRC field.	RW	1
RSVD	1		RV	0
Rx Enable	0	1 - Receive packets in the LCI. 0 - Discard all packets in the LCI. Must be set to receive packets into the receive buffer.	RW	0
RSVD	31:17	Reserved. Set to 0.	RV	0

**Table 74. LCI\_STATUS**

Name	Bit	Description	Type	Default
RSVD	4	Reserved. Set to 0.	RV	0
RSVD	3	Reserved. Set to 0.	RV	0



**Table 74. LCI\_STATUS (Continued)**

RX EOT	2	1 – Signals end of frame transmission. This bit does not raise an interrupt but it is redundant with the RX end of frame bit in the LCI_IP register. This is done so that software only needs to read one register.	CR	0
RX Ready	1	1 – Frame data is in the receive FIFO. 0 – There is no frame data in the receive FIFO. The transition from 0 to 1 occurs on a new frame. The transition from 1 to 0 occurs at the end of a frame.	RO	0
TX Ready	0	This signal is equivalent to the inverse of Pause. The pause watermarks exist for the switch port, and when pause is triggered this status bit changes to 0. When the port is “unpaused” this bit changes back to 0. Note: it is not anticipated under normal operation, that the CPU port will ever be paused.	RO	1
RSVD	31:5	Reserved. Set to 0.	RV	0

Notes:

1. RX Ready itself does not signal new frame or end of frame. Rx Ready could stay high over multiple packets.
2. The TX interrupt is equivalent to a change in state of TX Ready.

**Table 75. LCI\_RX\_FIFO**

Name	Bit	Description	Type	Default
RxData	31:0	Rx Data channel. All incoming packet data appears on this channel in FIFO order. At the end of the packet the LCI_RX_FRAME_STATUS register data is appended.	RO	0

**Table 76. LCI\_TX\_FIFO**

Name	Bit	Description	Type	Default
TxData	31:0	Tx Data channel. The CPU or DMA bridge writes exclusively to this register during packet transmission. See LCI functional description for the bit format and “in-band” control fields.	RW	0

Note:

See LCI description for treatment of endianness. Endianness only applies to RxData and TxData.

**Table 77. LCI\_IP**

Name	Bit	Description	Type	Default
LCI_TX Overrun	7	The frame being sent from the manager to the switch was corrupted because the switch did not have room to store the frame.	CR	0
LCI_RX Underflow	6	The frame being sent to the manager underflowed because all the frame data was not available in the switch quickly enough to keep up with the CPU interface	CR	0
LCI_RX Tail error	5	The frame being sent from the switch to the manager had the error bit set in the fabric	CR	0

**Table 77. LCI\_IP (Continued)**

LCI_RX Internal Error	4	There was an error on the frame being transmitted from the switch to the manager, however when it entered the switch from the network it was error free. So the switch generated the error.	CR	0
LCI_RX Error	3	There was an error on the frame being transmitted from the switch to the manager	CR	0
LCI_RX End	2	The switch is done transmitting the packet to the Manager.	CR	0
LCI_RX Request	1	A new packet has arrived for processing. That is, a frame from Ethernet port N > 0 headed for Port 0, has arrived in the switch and needs to be read from the LCI.	CR	0
TXRDY Transition	0	Either of the following two conditions: Change of pause state. The switch had been able to accept new frames from the manager and it no longer can, or vice versa, from a change in pause state. From an overflow in the RX buffer (switch port).	CR	0
RSVD	31:8	Reserved. Set to 0.	RV	0

*Note:*

By convention:

LCI\_RX means frames going to the CPU from the switch which have come from the network.

LCI\_TX means frames going from the CPU to the switch on their way to the network.

**Table 78. LCI\_IP**

Name	Bit	Description	Type	Default
Mask Interrupts	7:0	For each interrupt: 1 – Mask Interrupt 0 – Do not mask interrupt	RW	xFF
RSVD	31:8	Reserved. Set to 0.	RV	0

## 5.5 Bridge Registers

### 5.5.1 Switch Control Tables

#### 5.5.1.1 MAC Address Table

**Table 79. MAC Address Table**

	94:70	69	68	67	66:62	61..50	49..2	1	0
Address	Dest. Mask	Age	Lock	Valid	TRIG-ID	FID	MAC Address	RSVD	Parity
0									
...									
16,383									

#### Address Table Fields



- Destination Mask - a bit mask of the destination ports to which this address corresponds.
- TRIG-ID - Each trigger has a TRIG-ID and a defined in TRIGGER\_CFG. If the trigger calls for a single MAC address match, then of the 2 MAC address lookups, there must be one match for that trigger. If the trigger calls for a source address and destination address match, then both lookups must resolve to the same TRIG-ID as the trigger lookups.
- Parity - memory protection. A parity error is assumed to be a soft error in the table and is a reason to Reset the chip.
- Age - The age timer. 1 - The entry is new, 0 - The entry is old. Every time the table is accessed the bit is refreshed. If the age clock comes around between refreshes, it purges the table of the entry.
- Valid - The entry is valid.
- Lock - The entry may not be aged out of the table. It can only be removed from the CPU.
- FID - Learning Group. In shared spanning tree mode, FID = 0. In multiple spanning tree mode, FID = VID.
- MA Address - MAC address.

Notes:

1. The table is searched by MAC address and FID. That is, the same MAC address may exist once per VLAN in the table in multiple spanning tree mode. On a VLAN boundary violation, an address is not learned.
2. On a parity error, the line is considered invalid.
3. On power-up, all bits are zero by default.
4. MAC entries take 3 32-bit words to completely specify. The entries are aligned to 128 bit boundaries in address space, that is, one entry every four addresses.

**Table 80. MA\_TABLE\_CFG**

Name	Bit	Description	Type	Default
Hash Rotation	2:1	The hash function produces a 16 bit value. The hash address is only 12 bits. Which 4 bits are excluded is programmable. 0x0 - Bits 15:12 are not used. 0x1 - Bits 11:8 are not used. 0x2 - Bits 7:4 are not used. 0x3 - Bits 3:0 are not used.	RW	0x3
Source address lookup mode	0	1 - The source address lookup is only performed while the frame processor is ahead of the requests for destination address lookups. 0 - The source address lookup is performed on every frame. Note: This mode is incompatible with port security. It is used for achieving high event rate to support forwarding small packets at line rate. Normally, it should be set to 0.	RW	0
RSVD	31:3	Reserved. Set to 0.	RV	0

**Table 81. MA\_TABLE\_STATUS\_1**

Name	Bit	Description	Type	Default
Type	18:16	0x0 – Empty (No new entry since last read). 0x1 – Entry was learned. 0x2 – Entry was aged. 0x3 – Entry was a parity error. 0x4-0x7 – RSVD.	CR	0
Last learned/aged entry	15:0	Index of the most recently modified entry in the MAC address table.	CR	0
RSVD	31:19	Reserved. Set to 0	RV	0

Note:

There is a 64 place FIFO behind this. Once the value of the data is read, the register is cleared. If the switch has to place more than 64 changes in the FIFO ahead of the CPU, the FIFO fills up, and the reports of any subsequent table changes will be discarded and the “MA Status Buffer Overflow” interrupt in FRAME\_CTRL\_IP will be set. This implies that the MAC address table in the switch and the MAC address table in the host software are out of synchronization. The CPU now needs to re-read the entire table, to make the software image of the table consistent.

**Table 82. MA\_TABLE\_STATUS\_2**

Name	Bit	Description	Type	Default
Bin full count	31:16	Count of times an address was not learned from full bin.	CR	0
Bin Full Hash	11:0	Hash value of last bin that was full.	RO	0
RSVD	15:12	Reserved. Set to 0.	RV	0

**Table 83. MA\_TABLE\_STATUS\_3**

Name	Bit	Description	Type	Default
Skip LRN count	31:16	Count of the number of times a learning event was skipped because it is best effort and there wasn't time.	CR	0
Skip source address count	15:0	Count the number of times a source address lookup or learning event was not done because it is best effort and there wasn't time. (Learning events are always best-effort, source address lookup is only best-effort if the mode bit is set).	CR	0

**Table 84. VLAN ID Table**

	63:14	13	12:8	7:2	1	0
Address	Port Membership and Tag	RSVD	TRIG ID	VCNT	Reflect	Parity
0						
...						
4094						



### VLAN Table Fields

- VCNT - Check this index, and if VCNT < 32, then VCNT is the index into the counters for this VLAN to count octets, unicast frames, non-unicast frames in the VLAN.

Parity - If there is a parity error in the VLAN table it is grounds for resetting the chip.

Reflect - If this bit is set then the frame may be sent out the port it came in on, subject to the description in PORT\_CFG\_1.

TRIG ID - See section on monitoring.

Port Membership and Spanning tree state. 2 bits per port flood map (50 bits).

- b0 - Tag bit
  - 0 - Frame leaves untagged
  - 1 - Frame leaves tagged
- b1 - Membership bit
  - 0 - Port is not a member of this VLAN
  - 1 - Port is a member of this VLAN
- Port membership includes CPU.

On power-up all bits are zero by default.

In port-based VLAN there is no tagging, however this table is used to store the state of the membership lists. In that case the table is indexed by the port the traffic came in on, instead of the VLAN ID. The tag bit is ignored, as the frame always exits the switch unmodified. The membership bit indicates which ports can receive frames from the source port.

### 5.5.1.2 Forwarding Information Database (FID) Table

Each FID entry corresponds to a unique spanning tree.

Table 85. FID\_TABLE (Spanning Tree State Table)

	63:50	49:2	1	0
Address	RSVD	Spanning Tree State	RSVD	Parity
0				
...				
4094				

Two bits of spanning tree state per port. This facilitates multiple spanning tree learning.

- Disabled - All packets are discarded in this state. (b1b0=00)
- Listening - All packets but BPDUs are discarded in this state. (b1b0=01)





- Learning - All packets are discarded, however they are subject to Source lookups and learning. (b1b0=10)
- Forwarding - Port behaves normally. (b1b0=11)

Spanning Tree State does not include CPU (Port 0).

If the VLAN is not valid, that state is encoded by its membership group being zero. Then a Frame with that VID will be an Ingress and Egress boundary violation. Any VLAN boundary violation will lead to the frame not being learned. The frame may be discarded per security setting.

On Power up, all bits are zero by default.

## 5.5.2 Port Trunk Registers (Link-Aggregation)

**Table 86. TRUNK\_PORT\_MAP [1..24]**

Name	Bit	Description	Type	Default
Is mapped	4	1 – Port i is a member of the trunk group specified in LAG. 0 – Port i is not a member of any trunk group.	RW	0
LAG	3:0	Port i is a member of trunk group # 0x0-0xB are the 12 defined trunk groups. 0xC-0xF are reserved.	RW	0
RSVD	31:5	Reserved. Set to 0	RV	0

Notes:

1. Address of TRUNK\_PORT\_MAP[0] is RSVD.
2. There are 12 supported LAGs.
3. Port 0 is special and may not be configured into an LAG.

**Table 87. TRUNK\_GROUP\_1 [0..11]**

Name	Bit	Description	Type	Default
P6	29:25	Sixth port in the trunk group.	RW	0
P5	24:20	Fifth port in the trunk group.	RW	0
P4	19:15	Fourth port in the trunk group.	RW	0
P3	14:10	Third port in the trunk group.	RW	0
P2	9:5	Second port in the trunk group.	RW	0
P1	4:0	First port in the trunk group.	RW	0
RSVD	31:30	Reserved. Set to 0.	RV	0

**Table 88. TRUNK\_GROUP\_2 [0..11]**

Name	Bit	Description	Type	Default
P12	29:25	Twelfth in the trunk group.	RW	0
P11	24:20	Eleventh port in the trunk group.	RW	0
P10	19:15	Tenth port in the trunk group.	RW	0



**Table 88. TRUNK\_GROUP\_2 [0..11] (Continued)**

P9	14:10	Ninth port in the trunk group.	RW	0
P8	9:5	Eighth port in the trunk group.	RW	0
P7	4:0	Seventh port in the trunk group.	RW	0
RSVD	31:30	Reserved. Set to 0.	RV	0

**Table 89. TRUNK\_GROUP\_3 [0..11]**

Name	Bit	Description	Type	Default
Group Length	4:0	Number of ports in the trunk group.	RW	0
RSVD	31:5	Reserved. Set to 0.	RV	0

Notes:

1. The trunk is valid if the length is set to ? 1.
2. It is illegal, but not checked in the switch hardware for the following conditions, which will result in undefined behavior:
  - A port may not be a member of more than one trunk group.
  - The CPU port may not be in any trunk group.

**Table 90. TRUNK\_CANONICAL [1..24]**

Name	Bit	Description	Type	Default
Canonical Port	4:0	The physical port <i>i</i> maps to the canonical port. Valid values are 1 – 24.	RW	"I" equal to port number
RSVD	31:5	Reserved. Set to 0.	RV	0

The address of TRUNK\_CANONICAL[0] is RSVD. Port 0 is not mapped.

Note:

The ports in the MAC table are considered canonical and to get a physical port, this is the mapping. Thus to observe a frame coming out a statically mapped physical, the MAC address table must agree with the TRUNK\_CANONICAL register.



Table 91. TRUNK\_HASH\_MASK

Name	Bit	Description	Type	Default
Force Symmetric Hash (A4 and earlier silicon revisions)	6	0x0 – symmetric hash not enabled. 0x1 – The hash function will give the same result for: DA=MAC #1 and or SA=MAC #2 DA=MAC #2 and or SA=MAC #1 When Force Symmetric Hash is applied, the actual value of "Include DA" and "Include SA" are ignored and treated as true. The values of "Include VLAN-ID," and "Include VLAN-Pri" may be true or false, and should always result in preserving the symmetry. "Include Type and Source" may not be set to 0x2, or symmetry will be broken.  Note: This feature is used for Fat tree topologies where it is desired for the distribution function to resolve to the same uplink port (chip) for both sides of a conversation.	RW	0
Symmetric Hash Mode (A5 and later revisions of silicon)	6	Selects between two independent symmetric hash functions.  Note that "SA Symmetry" and "DA Symmetry" must both be set to 0 to enable symmetric hashing.	RW	0
Include VLAN-PRI	5	0x1 -- Include VLAN PRI. Note: This includes the CFI bit. (The field is a total of 4 bits)	RW	1
Include VLAN-ID	4	0x1 -- Include VLAN ID. (The field is 12 bits)	RW	1
Include Type and Source	3:2	0x0 -- Do not include the Type or Source field. 0x1 -- Include the Type and not the Source port. However if the Type < 0x600 then set Type to 0 (This prevents hashing on length) 0x2 -- Include the Source Port, but do not include the Type. 0x3 -- RSVD.	RW	0
Include SA (A4 and earlier revisions of silicon)	1	Include in the MASK the source address field (bytes 11:6)	RW	1
SA Symmetry (A5 and later revisions of silicon)	1	Allows for symmetric hashing when set to 0. When set to 1, the complete set of SA bits will be represented in the hash function in a manner that disrupts the SA/DA symmetry of the hash function.	RW	1
Include DA (A4 and earlier revisions of silicon)	0	Include in the MASK the destination address field (bytes 5:0)	RW	1
DA Symmetry (A5 and later revisions of silicon)	0	Allows for symmetric hashing when set to 0. When set to 1, the complete set of DA bits will be represented in the hash function in a manner that disrupts the SA/DA symmetry of the hash function.	RW	1
RSVD	31:7	Reserved. Set to 0	RV	0

Note: For a description of the type field, see IEEE 802.3-2002 page 40.



### 5.5.3 Filtering and Monitoring

**Table 92. TRIGGER\_CFG [0..15]**

Name	Bit	Description	Type	Default
MAC ID	31:28	TRIG ID for look-up. If the TRIG ID in this trigger [n] matches the TRIG ID in the MAC table or VID table, then the MAC and VLAN rules are checked for the trigger [n]. This applies to source and destination lookups and for VLAN match.	RW	0
Triggered Switch Priority	27:24	New switch priority associated with the frame when priority association actions are selected.	RW	0
Mirror Port	23:19	Port number of Mirror or redirect port.	RW	0x0 (CPU)
Action	18:16	0x0 – Forward Normally 0x1 – Redirect (send to mirror port only) 0x2 – Mirror (send to output port and mirror port) 0x3 – Discard. 0x4 – Forward normally and associate the frame with the Triggered Switch Priority 0x5 – Redirect and associate the frame with the Triggered Switch Priority 0x6 – Mirror and associate the frame with the Triggered Switch Priority. 0x7 – Reserved.  Note: these actions are mutually exclusive. Note: If the trigger fires, the trigger action is taken on the frame. The first trigger to fire in the precedence order of the trigger number 0..15, is the only trigger taken. There are counts for all triggers.	RW	0
RSVD	15:12	Reserved. Set to 0.	RV	0
Any one MAC address match	11	Requires either the source address or the destination address to match, or both.	RW	0
Priority	10	Require frame to have a switch priority match.	RW	0
Multicast	9	Require frame to be multicast.	RW	0
Broadcast	8	Require frame to be broadcast.	RW	0
Unicast	7	Require frame to be unicast.	RW	0
VLAN	6	Require a VLAN trigger match.	RW	0
Destination Port	5	Require a destination port mask match.	RW	0
Source Port	4	Require a source port mask match.	RW	0
Destination MAC miss	3	Require a destination MAC table miss.	RW	0
Destination MAC	2	Require a destination MAC trigger match.	RW	0
Source MAC miss	1	Require a source MAC table miss.	RW	1
Source MAC	0	Require a source MAC table match.	RW	1

- Notes:*
- 1) The default value of source MAC address hit and a source MAC address miss effectively disables the triggers, which is the default state.
  - 2) Trapped frames such as BDPU, GVRP, etc., are not subject to triggers.

**Table 93. TRIGGER\_PRI [0..15]**

Name	Bit	Description	Type	Default
Priority Mask	15:0	Switch priority mask for this trigger.	RW	0
RSVD	31:16	Reserved. Set to 0.	RV	0

**Table 94. TRIGGER\_RX [0..15]**

Name	Bit	Description	Type	Default
Source Port Mask	24:1	Source port mask for this trigger.	RW	0
RSVD	31:25,0	Reserved. Set to 0.	RV	0

**Table 95. TRIGGER\_TX [0..15]**

Name	Bit	Description	Type	Default
Destination Port Mask	24:1	Destination port mask for this trigger.	RW	0
RSVD	31:25,0	Reserved. Set to 0.	RV	0

## 5.6 Congestion Management

Any register in congestion management may be changed during device operation. This should not result in the corruption of any frames.

All addresses are offset by BASE.

BASE = 0x30E00

### 5.6.1 Priority Mapping

*Note:* Priority regeneration registers are located in the MAC section. That is, switch to Egress tag priority mapping. All other priority mappings are in the following registers. They are:

RX priority to switch priority

Switch priority to PWD priority

Switch priority to scheduling priority

**Table 96. RX\_PRI\_MAP [0..24]**

Name	Bit	Description	Type	Default
Pri7	31:28	Map ingress priority 7 to switch priority	RW	0x7
Pri6	27:24	Map ingress priority 6 to switch priority	RW	0x6
Pri5	23:20	Map ingress priority 5 to switch priority	RW	0x5
Pri4	19:16	Map ingress priority 4 to switch priority	RW	0x4
Pri3	15:12	Map ingress priority 3 to switch priority	RW	0x3



**Table 96. RX\_PRI\_MAP [0..24] (Continued)**

Pri2	11:8	Map ingress priority 2 to switch priority	RW	0x2
Pri1	7:4	Map ingress priority 1 to switch priority	RW	0x1
Pri0	3:0	Map ingress priority 0 to switch priority	RW	0x0

**Table 97. CM\_PRI\_MAP\_1**

Name	Bit	Description	Type	Default
Pri7	31:28	Map switch priority 7 to PWD priority	RW	0xD
Pri6	27:24	Map switch priority 6 to PWD priority	RW	0xD
Pri5	23:20	Map switch priority 5 to PWD priority	RW	0xD
Pri4	19:16	Map switch priority 4 to PWD priority	RW	0xD
Pri3	15:12	Map switch priority 3 to PWD priority	RW	0xD
Pri2	11:8	Map switch priority 2 to PWD priority	RW	0xD
Pri1	7:4	Map switch priority 1 to PWD priority	RW	0xD
Pri0	3:0	Map switch priority 0 to PWD priority	RW	0xD

**Table 98. CM\_PRI\_MAP\_2**

Name	Bit	Description	Type	Default
Pri15	31:28	Map switch priority 15 to PWD priority	RW	0xD
Pri14	27:24	Map switch priority 14 to PWD priority	RW	0xD
Pri13	23:20	Map switch priority 13 to PWD priority	RW	0xD
Pri12	19:16	Map switch priority 12 to PWD priority	RW	0xD
Pri11	15:12	Map switch priority 11 to PWD priority	RW	0xD
Pri10	11:8	Map switch priority 10 to PWD priority	RW	0xD
Pri9	7:4	Map switch priority 9 to PWD priority	RW	0xD
Pri8	3:0	Map switch priority 8 to PWD priority	RW	0xD

**Table 99. SCHED\_PRI\_MAP**

Name	Bit	Description	Type	Default
Pri15	31:30	Map switch priority 15 to scheduling priority	RW	0x3
Pri14	29:28	Map switch priority 14 to scheduling priority	RW	0x3
Pri13	27:26	Map switch priority 13 to scheduling priority	RW	0x2
Pri12	25:24	Map switch priority 12 to scheduling priority	RW	0x2
Pri11	23:22	Map switch priority 11 to scheduling priority	RW	0x1
Pri10	21:20	Map switch priority 10 to scheduling priority	RW	0x0
Pri9	19:18	Map switch priority 9 to scheduling priority	RW	0x0
Pri8	17:16	Map switch priority 8 to scheduling priority	RW	0x1
Pri7	15:14	Map switch priority 7 to scheduling priority	RW	0x3
Pri6	13:12	Map switch priority 6 to scheduling priority	RW	0x3
Pri5	11:10	Map switch priority 5 to scheduling priority	RW	0x2
Pri4	9:8	Map switch priority 4 to scheduling priority	RW	0x2

**Table 99. SCHED\_PRI\_MAP (Continued)**

Pri3	7:6	Map switch priority 3 to scheduling priority	RW	0x1
Pri2	5:4	Map switch priority 2 to scheduling priority	RW	0x0
Pri1	3:2	Map switch priority 1 to scheduling priority	RW	0x0
Pri0	1:0	Map switch priority 0 to scheduling priority	RW	0x1

## 5.6.2 Queue Management - PWD

The PWD algorithm requires a seed to configure the random number generator.

**Table 100. LFSR\_CFG**

Name	Bit	Description	Type	Default
Seed	30:0	Random seed.	RW	0
RSVD	31	Reserved. Set to 0.	RV	0

*Note:* The degenerate case of the random seed is x7FFFFFFF.

**Table 101. QUEUE\_CFG\_1 [0..24]**

Name	Bit	Description	Type	Default
TX Hog WM	25:16	TX queue size, based on 1024 byte values. Frames are dropped 100% at this watermark. Note that a frame causing the WM to be exceeded is not dropped. The next frame considered for that queue is dropped since the WM is now exceeded.	RW	0x0FF
RX Hog WM	9:0	RX queue size, based on 1024 byte values. For Switch PRI != 15 frames are dropped 100% at this watermark. Note that a frame causing the WM to be exceeded is not dropped. The next frame considered for that queue is dropped since the WM is now exceeded. Should be set higher than the Rx Private WM by at least a max frame size (round up to nearest 1024 byte value).	RW	0x0FF
RSVD	31:26, 15:10	Reserved. Set to 0.	RW	0

*Note:* The RX shared watermark and TX shared watermark default to 255 kB, or about 25% of the switch resources. These are "hog watermarks," protecting the switch from any one port needing too much of the switch resources. This arises during congestion.



**Table 102. QUEUE\_CFG\_2 [0..24]**

Name	Bit	Description	Type	Default
RX Private CFG	15	b1 – Discard frames that fail the TX shared check, even if the RX port associated with that frame has not exceeded its RX private watermark. b0 – Only discard frames that exceed both the TX shared and RX private watermarks.	RW	0
RX Private WM	9:0	RX queue size, based on 1024 byte values. This memory is protected from congestion management for unicast frames.	RW	0x10
RSVD	31:16, 14:10	Reserved. Set to 0.	RW	0

*Note:* The RX private watermark default to 16 kB (0x10), the total amount of private memory is 400 kB for 24 ports, or about 38% of the memory. 16k is chosen to guarantee a jumbo packet may be received on an empty port, irrespective of the congestion of the shared memory. RX private watermark does not enter into the calculation for flow control.

**Table 103. QUEUE\_CFG\_3**

Name	Bit	Description	Type	Default
Switch Pri WM Select	$2*i+1:2*i$ ( $15 \geq i \geq 0$ )	0x0 – All frames in this switch priority are checked against the low global watermark for PWD. 0x1 – All multicast and broadcast frames in this switch priority are checked against the low global watermark for PWD, but all unicast frames in this switch priority are checked against the high global watermark 0x2 – All frames in this switch priority are check against the high global watermark for PWD 0x3 – All frames in this switch priority are checked against the privileged watermark only (no PWD).	RW	0x1

**Table 104. QUEUE\_CFG\_4**

Name	Bit	Description	Type	Default
RSVD	31:28	Reserved. Set to 0.	RV	0
Global High Watermark	27:16	Global high watermark based on 1024 byte values. If the frame matches a type in QUEUE_CFG_3 configured to be checked against the high watermark, then the PWD line for that frame intersects this watermark at 100% drop probability.	RW	0x21C
RSVD	15	Reserved. Set to 0.	RV	0
RSVD	14:12	Reserved. Set to 0.	RV	0
Global low Watermark	11:0	Global low watermark based on 1024 byte values. If the frame matches a type in QUEUE_CFG_3 configured to be checked against the low watermark, then the PWD line for that frame intersects this watermark at 100% drop probability.	RW	0x21C





*Note:* The low global watermark defaults to leaving about 15% of the memory empty for high priority traffic assuming 16KB RX private FIFOs. The calculation is:

$$0.85 * \{ 1024 \text{ kB (total memory)} - \sum \text{RX Private}(i) \} = 540 \text{ kB (0x21C)}$$

**Table 105. QUEUE\_CFG\_5**

Name	Bit	Description	Type	Default
Global Watermark - Privileged	11:0	Global queue size, based on 1024 byte values. All frames are dropped 100% at this watermark.	RW	0x3d0
RSVD	32:12	Reserved. Set to 0.	RV	0

**Table 106. STREAM\_STATUS\_1 [0..24]**

Name	Bit	Description	Type	Default
TX Queue Status	27:16	Number of 1024 byte segments that are occupied in this TX Queue.	RO	0
RX Queue Status	11:0	Number of 1024 byte segments that are occupied in this RX Queue.	RO	0
RSVD	31:28, 15:12	Reserved. Set to 0.	RV	0

**Table 107. STREAM\_STATUS\_2**

Name	Bit	Description	Type	Default
Global Shared Queue Status	27:16	Number of 1024 byte segments that are in the shared portion of the memory. That is, the total memory segment usage minus the segments in the private RX queues.	RO	0
Global Queue Status	11:0	Number of 1024 byte segments that are occupied in the stream memory. Total segments.	RO	0
RSVD	31:28, 15:12	Reserved. Set to 0.	RV	0



**Table 108. EGRESS\_SCHEDULE\_1 [0..24]**

Name	Bit	Description	Type	Default
WRR Ports	3:2	Number of ESPQ in strict priority mode, counted from the highest priority ESPQ downward. 0x3 – All queues are WRR. 0x2 – The lowest 3 priority queues are WRR. 0x1 – The lowest 2 priority queues are WRR. 0x0 – All queues are strict priority. Any queues which are not WRR are strict priority. If they are weighted round robin, then the service order and weights are used to determine the scheduling.	RW	0
Service mode	1:0	This only applies to the WRR mode. 0x0 – Priority Round Robin. 0x1 – Reserved. 0x2 – Pure Round Robin. 0x3 – RSVD.	RW	0
RSVD	31:4	Reserved. Set to 0.	RV	0

**Table 109. EGRESS\_SCHEDULE\_2 [0..24]**

Name	Bit	Description	Type	Default
Weight Queue 3	31:24	0x01-0xFF - Number of packets per turn in Queue 3. 0x00 - Illegal value, undefined behavior.	RW	x0F
Weight Queue 2	23:16	0x01-0xFF - Number of packets per turn in Queue 2. 0x00 - Illegal value, undefined behavior.	RW	x07
Weight Queue 1	15:8	0x01-0xFF - Number of packets per turn in Queue 1. 0x00 - Illegal value, undefined behavior.	RW	x03
Weight Queue 0	7:0	0x01-0xFF - Number of packets per turn in Queue 0. 0x00 - Illegal value, undefined behavior.	RW	x01

*Note:* Weights assigned to queues in Strict Priority mode have no relevance.

**Table 110. GLOBAL\_PAUSE\_WM [0..24]**

Name	Bit	Description	Type	Default
Pause OFF	27:16	The occupancy of 1024 byte segments in the global shared memory that ends the transmission of Pause frames out of the port. That is, not total memory, but sum of all ports above their RX private watermark.	RW	x120
Pause ON	11:0	The occupancy of 1024 byte segments in the global shared memory that initiates the transmission of Pause frames out of the port. In addition, the RX private watermark must be surpassed on any port before it will generate Pause messages.	RW	x144
RSVD	31:28, 15:12	Reserved. Set to 0.	RV	0

**Table 111. RX\_PAUSE\_WM [0..24]**

Name	Bit	Description	Type	Default
Pause OFF	27:16	The occupancy of 1024 byte segments in the RX Status that ends the transmission of Pause frames out of the port.	RW	x0F5
Pause ON	11:0	The occupancy of 1024 byte segments in the RX Status that initiates the transmission of Pause frames out of the port.	RW	x0FF
RSVD	31:28, 15:12	Reserved. Set to 0.	RV	0

The RX pause watermark refers to the total RX status, not the portion of RX status that contributes to the shared memory (RX total - RX private). The defaults for RX\_PAUSE\_WM are calculated by:

Pause on : 25% of the memory

Pause off: Pause on - 16 kB

The following further restrictions apply to transmitting Pause Frames:

- Once the smaller Pause On watermark is achieved (global or per-port), that port will begin transmitting pause frames.
- Once both queues are below their pause off watermarks, that port will end transmitting pause frames.
- In order to send any pause frames, the per-port configuration of RX pause on must be set.

The CPU port (port 0) reports pause status in an out of band register, and the CPU may react to it anyway it pleases. There are no pause frames sent to the CPU interface.

### 5.6.3 Switch Latency

This section provides information on configuration of the cut-through and store-and-forward modes, on a per-port-pair basis.

**Table 112. SAF\_MATRIX [0]**

Name	Bit	Description	Type	Default
RSVD	j	Reserved. Set to 1.	RW	1
RSVD	31:25	Reserved. Set to 1.	RV	1

The ports are grouped into the following banks:

The CPU, port 0, is always store-and-forward.



Table 113. SAF\_MATRIX [1..24]

Name	Bit	Description	Type	Default
SNF port-pair i-j	j (1:24)	Frames sent from Port i to Port j are store-and-forward.	RW	0
RSVD	0	Reserved. Set to 1.	RV	1
RSVD	31:25	Reserved. Set to 1.	RV	1

**Caution:** It is illegal for a port-pair to be cut-through if the clocks of the two ports differ by more than +/- 100 PPM. This will result in under-run from the slower port to the faster port. For this reason the CPU port must always be store-and-forward.

Table 114. JITTER\_WATERMARK

Name	Bit	Description	Type	Default
TX Jitter CT	21:16	Number of frame handler clock cycles before transmission of a cut-through frame. This counter applies if the frame is not store-and-forward and the scheduler does not know whether the data path has finished storing the frame when the scheduler schedules the frame.	RW	0x20
TX Jitter SF	13:8	Number of frame handler clock cycles before transmission of a frame that meets the following condition: The writing of the frame is at least one segment (256 bytes) ahead of the reading of the frame. Note: This applies to store-and-forward traffic, as well as cut-through traffic that has at least a segment in the memory as a result of switch congestion.	RW	0x20
TX Jitter SS	5:0	Number of EPL clock cycles before starting transmission of a frame that is one sub-segment in length (64 bytes) or less.	RW	0x20
RSVD	31:22, 15:14, 7:6	Reserved. Set to 0.	RV	0

## 5.7 Statistics

With few exceptions, all counters are 64 bits in the FM2112. The 64-bit counters are stored least significant 32-bit word first (even address). The MIB counters may be read as rarely or often as desired. A MIB counter must be read one at a time. The counters are listed in groups. Each counter in a group is mutually exclusive.

The MIB counters are split into two types: RMON and non-RMON counters. For RMON counters, the FM2112 implements the standard set of counters with no additions or deletions. There are two categories of exceptions to this rule:

- Any counter which is not meaningful in 802.3ae has been deleted. (RxAlignment Errors, TX collisions, etc)



- Packet size bins have been expanded to include some non-standard Ethernet packets, but these bins are only counted if the FM2112 is configured to allow the transmission of non-standard frame sizes.

The FM2112 contains additional counters beyond the traditional RMON MIB definitions. These counters are not targeted at well established software applications. Instead, their definition follows the principle that if the FM2112 has a rule to treat a specific class of packets in a certain way, then that treatment is counted. From this principle follows the security, filtering, and priority based counters, user programmable triggers and VLAN statistics.

### 5.7.1 Statistics Registers

**Table 115. STATS\_CFG**

Name	Bit	Description	Type	Default
RSVD	11	Reserved. Set to 0	RW	0
RSVD	10	Reserved. Set to 0.	RW	0
Group 8 Enable	9	Enable all group 8 counters.	RW	1
Group 7 Enable	8	Enable all group 7 counters.	RW	1
RSVD	7	Reserved. Set to 0.	RW	0
Group 3 Enable	6	Enable all group 3 counters.	RW	1
Group 5 Enable	5	Enable all group 5 counters.	RW	1
RSVD	4	Reserved. Set to 0.	RW	0
Group 6 Enable	3	Enable all group 6 counters.	RW	1
Group 4 Enable	2	Enable all group 4 counters.	RW	1
Group 2 Enable	1	Enable all group 2 counters.	RW	1
Group 1 Enable	0	Enable all group 1 counters.	RW	1
RSVD	31:12	Reserved. Set to 0.	RV	0

**Table 116. STATS\_DROP\_COUNT**

Name	Bit	Description	Type	Default
Drop Count 2	31:16	Number of counter updates in groups 7-9 that were dropped due to counter event rate issues.	CR/W	0
Drop Count 1	15:0	Number of counter updates in groups 1-6 that were dropped due to counter event rate issues.	CR/W	0

### 5.7.2 Counter Groups

There are 13 groups of counters excluding the extra counters in the Ethernet Port Logic. They are:

Per-port counters (one set per port):

- Group 1: RX packet counters per type.



- Group 2: RX packet counters per size.
- Group 3: RX octet counters.
- Group 4: RX packet counters per priority.
- Group 5: RX octet counters per priority.
- Group 6: RX packet counters per flow.
- Group 7: TX packet counters per type.
- Group 8: TX packet counters per priority.
- Group 9: TX octet counters.

**Non-per port counters:**

- Group 10: Congestion management packet counters (one global set).
- Group 11: VLAN octet counters (32 sets, assigned per VLAN).
- Group 12: VLAN packet counters (32 sets, assigned per VLAN).
- Group 13: Trigger packet counters (16 sets, one per trigger).

**Table 117. Group 1 Counters - RX Packet Counters per Type [0..24]**

Name	Description	Address
RxUcast	Unicast frames received. (Note: oversize and undersize frames with good or bad CRC are counted. Proper size frames with bad CRC are not counted; they are counted as RxFCSErrors.)	0x70000+0x200*i
RxBcast	Valid broadcast frames received (good frames only).	0x70002+0x200*i
RxMcast	Valid multicast frames received (good frames only, does not include broadcast or Pause frames).	0x70004+0x200*i
RxPause	Valid received pause frames	0x70006+0x200*i
RxFCSErrors	Received frames of proper size but CRC error, and integral number of octets.	0x70008+0x200*i
RxSymbolErrors	Received frames of proper size, but with symbol error.	0x7000A+0x200*i

**Table 118. Group 2 Counters - RX Packet Counters per Size [0..24]**

Name	Description	Address
RxMinto63	Received frames of < 64 octets that are not error frames because the min frame size is set below the Ethernet minimum (good and bad frames counted).	0x70080+0x200*i
Rx64	Received frames of 64 octets (good and bad frames counted).	0x70082+0x200*i
Rx65to127	Received frames of 65 to 127 octets (good and bad frames counted).	0x70084+0x200*i
Rx128to255	Received frames of 128 to 255 octets (good and bad frames counted).	0x70086+0x200*i
Rx256to511	Received frames of 256 to 511 octets (good and bad frames counted).	0x70088+0x200*i
Rx512to1023	Received frames of 512 to 1023 octets (good and bad frames counted).	0x7008A+0x200*i
Rx1024to1522	Received frames of 1024 to 1522 octets (good and bad frames counted).	0x7008C+0x200*i
Rx1523to2047	Received frames of 1523 to 2047 octets (good and bad frames counted).	0x7008E+0x200*i

**Table 118. Group 2 Counters - RX Packet Counters per Size [0..24]**

Rx2048to4095	Received frames of 2048 to 4095 octets (good and bad frames counted).	0x70090+0x200*i
Rx4096to8191	Received frames of 4096 to 8191 octets (good and bad frames counted).	0x70092+0x200*i
Rx8191to10239	Received frames of 8192 to 10239 octets (good and bad frames counted).	0x70094+0x200*i
Rx10240toMax	Received frames of 10240 to MaxFrame octets. Note: Maxframe is configurable. This counter will only be activated if MaxFrame is > 10240. That is it is the count of non-error frames above 10240. In any case, Intel® strongly recommends against sending packets above 10240 octets, as the Ethernet CRC is no longer valid.	0x70096+0x200*i
RxFragments	Received frames smaller than Min Sized Frame octets with either a CRC or alignment error.	0x7009C+0x200*i
RxUndersized	Received frames smaller than the minimum frame size but otherwise well formed with a good CRC.	0x70098+0x200*i
RxJabbers	Received frames greater than MaxFrame octets and alignment error and good or bad CRC. This counter is only 16 bits.	0x80029+0x400*(N-1)
RxOversized	Received frames greater than MaxFrame octets . This counter includes oversized well formed packets as well oversized packets with bad a CRC or an alignment problem. The software must read the counter STAT_RX_JABBER[Jabber Count] in the EPL to detect how many of the oversized frames where actually malformed packets. NOTE: If the frame is counted here, it is not counted in a bin counter RxXXXXtoYYYY even if it fits in that bin.	0x7009A+0x200*i

**Table 119. Group 3 Counters - RX Octet Counters [0..24]**

Name	Description	Address
RxGoodOctets	Received octets on good packets.	0x700A0+0x200*i
RxBadOctets	Received octets on bad packets. Note: total received octets is the sum of RxGoodOctets and RxBadOctets.	0x700A2+0x200*i

**Table 120. Group 4 Counters - RX Packet Counters per Priority [0..24]**

Name	Description	Address
RxP0	Received frames of priority 0.	0x70010+0x200*i
RxP1	Received frames of priority 1.	0x70012+0x200*i
RxP2	Received frames of priority 2.	0x70014+0x200*i
RxP3	Received frames of priority 3.	0x70016+0x200*i
RxP4	Received frames of priority 4.	0x70018+0x200*i
RxP5	Received frames of priority 5.	0x7001A+0x200*i
RxP6	Received frames of priority 6.	0x7001C+0x200*i
RxP7	Received frames of priority 7.	0x7001E+0x200*i



**Table 121. Group 5 Counters - RX Octet Counters per Priority [0..24]**

Name	Description	Address
RxOctetsP0	Received octets on Priority 0.	0x70120+0x200*i
RxOctetsP1	Received octets on Priority 1.	0x70122+0x200*i
RxOctetsP2	Received octets on Priority 2.	0x70124+0x200*i
RxOctetsP3	Received octets on Priority 3.	0x70126+0x200*i
RxOctetsP4	Received octets on Priority 4.	0x70128+0x200*i
RxOctetsP5	Received octets on Priority 5.	0x7012A+0x200*i
RxOctetsP6	Received octets on Priority 6.	0x7012C+0x200*i
RxOctetsP7	Received octets on Priority 7.	0x7012E+0x200*i

**Table 122. Group 6 Counters - RX Packet Counters per Flow [0..24]**

Name	Description	Address
FIDForwarded	Number of frames that were forwarded normally, either unicast or multicast, as a result of a lookup of a valid entry in the MAC address table, or a broadcast. Note: This counter does not count mirrored frames.	0x70100+0x200*i
FloodForwarded	Number of good unicast addressed frames that were flooded because the destination is unknown, or an unregistered multicast.	0x70102+0x200*i
TriggerMirrored	Number of good frames that were mirrored. Note: Total number of normally forwarded packets = FIDForwarded + FloodForwarded + TriggerMirrored (note that trapped frames are not subject to triggers, so are not mirrored). This counter is only incremented if flooding is enabled in the switch.	0x70112+0x200*i
STPDrops	Number of frames that were dropped because either the ingress or egress port is not in the forwarding spanning tree state, resulting in a frame drop on ingress.	0x70104+0x200*i
ReservedTraps	Number of frames that are trapped to the CPU and not forwarded normally, as a result of any of the three specific trap functions: Destination address = IEEE reserved group address (as configured in SYS_CFG_1) Destination address = CPU MAC address (as configured in SYS_CFG_3 and SYS_CFG_4) Ether-type = Ether-type trap (as configured in SYS_CFG_6)	0x70106+0x200*i
BroadcastDrops	Number of frames that were dropped with DA=xFFFFFFFF because storm control is enabled.	0x70116+0x200*i
SecurityViolationDrops	Number of frames that are dropped or trapped because they are considered a security violation.	0x70108+0x200*i
VLANTagDrops	Number of frames discarded because the frames were untagged, and drop untagged is configured, or the frames were tagged, and drop tagged is configured.	0x7010A+0x200*i



**Table 122. Group 6 Counters - RX Packet Counters per Flow [0..24]**

VLANIngressBVDrops	Number of frames dropped for an Ingress VLAN boundary violation. Note: This only applies to 802.1Q, because in port-based VLAN there is no such thing as an ingress violation.	0x7010C+0x200*i
VLANEgressBVDrops	Number of frames dropped for an Egress VLAN boundary violation. This does not mean the number of ports filtered by the VLAN membership list in a multicast or flood; it means the destination address corresponds to a port that is not (or no longer) in the VLAN membership list, so the frame was dropped and not forwarded.	0x7010E+0x200*i
TriggerRedirAndDrops	Number of frames that were dropped or redirected because they caused a user defined trigger to fire.	0x70110+0x200*i
DlFDrops	Number of frames that were discarded because there was a destination lookup failure and flooding is not enabled in the switch. Note: This counter is incremented for unicast. & multicast	0x70114+0x200*i
CMRx Drops	Number of frames dropped for exceeding the RX shared watermark.	0x70118+0x200*i

**Table 123. Group 7 Counters - TX Packet Counters per Type [0..24]**

Name	Description	Address
TxUnicast	Unicast frames transmitted, possibly with incorrect FCS due to cut-through. (Note: undersized frames that have been padded to the min size (MAC_CFG_2[PadMinSize]=1) are counted.)	0x70020+0x200*i
TxBroadcast	Broadcast frames transmitted, possibly with incorrect FCS due to cut-through.	0x70022+0x200*i
TxMulticast	Multicast frames transmitted, possibly with incorrect FCS due to cut-through.	0x70024+0x200*i
TxPause	Transmitted pause frames, and valid FCS. This counter is a 32 bit counter only.	0x00026+0x400*(N-1)
TxFCSErrors	Transmitted frames with FCS errors. (Note: undersized frames that have been padded to the min size (MAC_CFG_2[PadMinSize]=1) are not counted even though they have a forced bad CRC.) This counter is a 32 bit counter only. Also described in <a href="#">where????</a>	0x00027+0x400*(N-1)
TxErrorDrops	The number of frames that were marked on ingress as erroneous (either due to an FCS or PHY error, or due to under/over size problems) which the switch element actually managed to discard. Frames marked as erroneous on ingress which were transmitted (due to cut-through) will not be included in this counter.	0x70028+0x200*i
TxTimeoutDrops	A frame in a TX queue was dropped as a result of a timeout.	0x70026+0x200*i



**Table 124. Group 8 Counters - TX Packet Counters per Size [0..24] \***

Name	Description	Address
TxMinto63	Transmitted frames of min frame size to 63 octets. This counter is for non-error frames that are less than 64 octets because the min frame size is set below 64 octets in the MAC, or error frames that the switch transmitted anyway because MAC_CFG_2[Min Frame Discard] was not set (includes bad frames)	0x700A8+0x200*i
Tx64	Transmitted frames of 64 octets. (includes bad frames)	0x700AA+0x200*i
Tx65to127	Transmitted frames of 65 to 127 octets. (includes bad frames)	0x700AC+0x200*i
Tx128to255	Transmitted frames of 128 to 255 octets. (includes bad frames)	0x700AE+0x200*i
Tx256to511	Transmitted frames of 256 to 511 octets. (includes bad frames)	0x700B0+0x200*i
Tx512to1023	Transmitted frames of 512 to 1023 octets. (includes bad frames)	0x700B2+0x200*i
Tx1024to1522	Transmitted frames of 1024 to 1522 octets. (includes bad frames)	0x700B4+0x200*i
Tx1523to2047	Transmitted frames of 1522 to 2047 octets. (includes bad frames)	0x700B6+0x200*i
Tx2048to4095	Transmitted frames of 2048 to 4095 octets. (includes bad frames)	0x700B8+0x200*i
Tx4096to8191	Transmitted frames of 4096 to 8191 octets. (includes bad frames)	0x700BA+0x200*i
Tx8192to10239	Transmitted frames of 8192 to 10239 octets. (includes bad frames)	0x700BC+0x200*i
Tx10240toMax	Transmitted frames of 10240 to MaxFrame octets. (includes bad frames). This counter will only be activated if Maxframe is > 10240. That is it is the count of non-error frames above 10240. However, Intel® strongly recommends not sending packets above 10240, as the Ethernet CRC isn't long enough.	0x700BE+0x200*i

*Note:* Packet lengths are calculated before any frame length modifications are made by the EPL (Ethernet Port Logic) such as VLAN tag removal, for example.

**Table 125. Group 9 Counters - TX Octet Counters [1..24]**

Name	Description	Address
TxOctets	Transmitted octets including CRC but excluding preambles and inter-frame characters.	Port 1...N: 0x802C + 0x400*(i-1)

**Table 126. Group 10 Counters - Congestion Management Counters**

Name	Description	Address
CMTxDrops[0..24]	Count of frames dropped for congestion management from TX port 0.	0x66080+2*i
CMGlobalLowDrops	Count of frames dropped for congestion management from the global low PWD watermark.	0x66000
CMGlobalHighDrops	Count of frames dropped from the global high PWD watermark.	0x66002
CMGlobalPrivilegeDrops	Count of frames dropped from the global privilege watermark.	0x66004



*Note:* The CMTxDrop[n] refer to the shared watermarks only. A packet is only dropped (and counted) for one reason, though there may be multiple watermark checks that a frame has to pass before it is forwarded, there is only one PWD check.

**Table 127. Group 11 Counters - VLAN Octet Counters [0..31]**

Name	Description	Address
VLANUnicastOctets[i]	Unicast octets received on VLAN[i].	0x66180+2*i
VLANXcastOctets[i]	Broadcast and multicast octets received on VLAN[i].	0x661C0+2*i

**Table 128. Group 12 Counters - VLAN Packet Counters [0..31]**

Name	Description	Address
VLANUnicast[i]	Unicast frames received on VLAN[i]	0x66100+2*i
VLANXcast[i]	Broadcast and multicast frames received on VLAN[i]	0x66140+2*i

*Note:*  $0 \leq i \leq 31$ . See VCNT field in VID table. This is the index i.

**Table 129. Group 13 Counters - Trigger Counters [0..16]**

Name	Description	Address
TrigCount[i]	Number of times trigger "I" was taken, where $0 \leq i \leq 15$ .	0x660C0+2*i
TrigCount[16]	No trigger was taken.	0x660E0

## 5.8 EPL Registers

### 5.8.1 SERDES Registers

**Table 130. SERDES\_CTRL\_1 [1..8]**

Name	Bit	Description	Type	Default
DEQ Lane D	31:28	Equalization for lane D.	RW	0
DEQ Lane C	27:24	Equalization for lane C.	RW	0
DEQ Lane B	23:20	Equalization for lane B.	RW	0
DEQ Lane A	19:16	Equalization for lane A.	RW	0
DTX Lane D	15:12	Current drive for lane D.	RW	0
DTX Lane C	11:8	Current drive for lane C.	RW	0
DTX Lane B	7:4	Current drive for lane B.	RW	0
DTX Lane A	3:0	Current drive for lane A.	RW	0

**Table 131. SERDES\_CTRL\_1 [9..24]**

Name	Bit	Description	Type	Default
RSVD	31:20	Reserved. Set to 0.	RW	0
DEQ	19:16	Equalization for single SerDes output.	RW	0
RSVD	15:12	Reserved. Set to 0.	RW	0
DTX	3:0	Current drive for single SerDes output.	RW	0



**Table 132. Equalization and Driver Table**

Dtx[3:0]	Actual/Nominal Current	Deq[3:0]	Ieq/Idr versus Deq[3:0]
0000	1.00	0000	0.00
0001	1.05	0001	0.04
0010	1.10	0010	0.08
0011	1.15	0011	0.12
0100	1.20	0100	0.16
0101	1.25	0101	0.20
0110	1.30	0110	0.24
0111	1.35	0111	0.28
1000	0.60	1000	0.32
1001	0.65	1001	0.36
1010	0.70	1010	0.40
1011	0.75	1011	0.44
1100	0.80	1100	0.48
1101	0.85	1101	0.52
1110	0.90	1110	0.60
1111	0.95	1111	0.65

**Table 133. SERDES\_CTRL\_2 [1..8]**

Name	Bit	Description	Type	Default
PLL Reset CD	17	PLL reset of the PLL that covers lanes C and D.	RW	1
PLL Reset AB	16	PLL reset of the PLL that covers lanes A and B.	RW	1
Lane Power Down	15:12	Independent lane power down. 1 bit per lane. Note: Interfaces 1-8 operate in 4 lane or 1 lane modes only. In the one lane mode, only lane 0 or lane 3 will be enabled.	RW	b1111
Lane Reset	11:8	Independent lane reset. 1 bit per lane.	RW	b1111
High Drive	7:4	1 bit per lane. See table.	RW	0
Low Drive	3:0	1 bit per lane. See table.	RW	0
RSVD	31:18	Reserved. Set to 0.	RV	0

*Note:* The 2 bit number constructed from 1 bit per lane of the Low Drive field and one bit per lane of the High Drive field is used to encode the nominal drive current, according to the following table:

**Table 134. SERDES\_CTRL\_2 [9..24]**

Name	Bit	Description	Type	Default
RSVD	17	Reserved. Set to 1.	RW	1
PLL Reset	16	PLL reset of the PLL that covers the single SerDes	RW	1
RSVD	15:13	Reserved. Set to 1.	RW	b111
Lane Power Down	12	Single lane power down.	RW	1

**Table 134. SERDES\_CTRL\_2 [9..24] (Continued)**

RSVD	11:9	Reserved. Set to 1.	RW	b111
Lane Reset	8	Reset for single SerDes..	RW	1
RSVD	7:5	Reserved. Set to 0.	RW	0
High Drive	4	High drive for single SerDes.	RW	0
RSVD	3:1	Reserved. Set to 0.	RW	0
Low Drive	0	Low drive for single SerDes.	RW	0
RSVD	31:18	Reserved. Set to 0.	RV	0

**Table 135. Nominal SERDES Drive Current**

HiDrv	LoDrv	Nominal Driver Current
0	0	20mA
0	1	10mA
1	0	28mA
1	1	Reserved

**Table 136. SERDES\_CTRL\_3 [1..24]**

Name	Bit	Description	Type	Default
DC	19:0	Lane locked and signal detect de-assertion count. Number of cycles to count before de-asserting SD bit in SERDES STATUS register. (CX4 spec is 250us) and LU in PCS Status register (default: 78,125)	RW	x1312D
RSVD	31:20	Reserved. Set to 0.	RV	0

**Table 137. SERDES\_TEST\_MODE [1..24]**

Name	Bit	Description	Type	Default
FE	6	Enables PCS framer. The function of the PCS framer is to look for the comma character and instruct the SERDES I/O to shift by a certain number of bits when the comma character is not properly aligned. The PCS framer must be enabled at all time except during SERDES testing using BIST.	RW	1
BS	5	Synchronizes the RX BIST checker. When register de-asserted allows RX BIST to start checking. Change in state is delayed by 5 cycles to allow for starting of pattern through setting BM and also de-assertion the BS bit.	RW	1



**Table 137. SERDES\_TEST\_MODE [1..24] (Continued)**

Test Mode	4:3	Test Mode 0x0 – normal -default 0x1 - Parallel Loop-back 0x2-0x3 – RSVD	RW	0
BIST Mode	2:0	0x0 – Disabled 0x1 – PRBS, Test Data = $x^9+x^5+1$ 0x2 – Test Data = D21.5 Pattern 0x3 – Test Data = K28.5(Idle) Pattern 0x4 – Test Data = K28.7(Test) Pattern 0x5 – PRBS, Test Data = $x^{10}+x^3+1$ 0x6 – PRBS, Test Data = $x^9+x^4+1$ 0x7 – PRBS, Test Data = $X^7+1$	RW	0
RSVD	31:6	Reserved. Set to 0.	RV	0

**Table 138. SERDES\_STATUS [1..24]**

Name	Bit	Description	Type	Default
Signal Detect	4	Signal Detect based on all four lanes (quad SerDes). There is hysteresis in this status, see SERDES_CTRL_3. For quad SerDes in 1 lane mode, the Signal detect is only based on lane A or lane D, depending the lane reversal state. For single SerDes interfaces, pertains to the single operational SerDes. Note that when in SerDes Loopback mode, Signal Detect is achieved but not displayed via this bit.	RO	0
Symbol Lock	3:0	Symbol Lock. 1 bit per lane. In 1 lane mode only the 1 active lane should be read for polling the lock status. The other 3 bits are undefined. For single SerDes interfaces, only lane A should be read. The other 3 bits are undefined.	RO	0
RSVD	31:5	Reserved. Set to 0.	RV	0

**Table 139. SERDES\_IP [1..8]**

Name	Bit	Description	Type	Default
EC	31:12	Saturating Error counter – increments once per any kind of error in any lane. For instance if all 12 errors(3 per lane) were asserted the Error count would increment by 1	CR	0
ER3DE	11	Lane D Disparity Error.	CR	0
ER3BC	10	Lane D Out of band Character.	CR	0
ER3LS	9	Lane D Loss of Signal.	CR	0
ER2DE	8	Lane C Disparity Error.	CR	0
ER2BC	7	Lane C Out of band Character.	CR	0
ER2LS	6	Lane C Loss of Signal.	CR	0
ER1DE	5	Lane B Disparity Error.	CR	0
ER1BC	4	Lane B Out of band Character.	CR	0
ER1LS	3	Lane B Loss of Signal.	CR	0

**Table 139. SERDES\_IP [1..8] (Continued)**

ER0DE	2	Lane A Disparity Error.	CR	0
ER0BC	1	Lane A Out of band Character.	CR	0
ER0LS	0	Lane A Loss of Signal.	CR	0

*Note:* The interrupt detect field for SERDES\_IP is only the OR of bits 11:0. Not the counter.

**Table 140. SERDES\_IP [9..24]**

Name	Bit	Description	Type	Default
EC	31:12	Saturating Error counter – increments once per any kind of error. For instance if all 3 errors were asserted the Error count would increment by 1	CR	0
RSVD	11:3	Reserved	CR	0
ER0DE	2	Disparity Error.	CR	0
ER0BC	1	Out of band Character.	CR	0
ER0LS	0	Loss of Signal.	CR	0

**Table 141. SERDES\_IM [1..8]**

Name	Bit	Description	Type	Default
Interrupt Mask	11:0	1 – Mask interrupt. 0 – Do not mask interrupt.	RW	XFFF
RSVD	31:12	Reserved. Set to 0.	RV	0

**Table 142. SERDES\_IM [9..24]**

Name	Bit	Description	Type	Default
Interrupt Mask	2:0	1 – Mask interrupt. 0 – Do not mask interrupt.	RW	b111
RSVD	31:3	Reserved. Set to 0.	RV	0

**Table 143. SERDES\_BIST\_ERR\_CNT [1..8]**

Name	Bit	Description	Type	Default
BEC	31:0	8 bits per lane. Saturating counter.	CR	0

**Table 144. SERDES\_BIST\_ERR\_CNT [9..24]**

Name	Bit	Description	Type	Default
RSVD	31:8	Reserved. Set to 0.	CR	0
BEC	7:0	Saturating counter for single SerDes interfaces	CR	0



### 5.8.2 PCS Registers

Table 145. PCS\_CFG\_1 [1..24]

Name	Bit	Description	Type	Default
RSVD	31	Reserved. Set to 0	RW	0
DS	30:29	Datapath structure 2'b00: 4lanes (10Gb) [Note that this setting is not valid for interfaces 9-24, where only a single lane is operational.] 2'b01: 1 lane (1Gb) 2'b10: 1 lane – 1/10 effective data rate (100Mb) 2'b11: 1 lane – 1/100 effective data rate (10Mb)	RW	0
AA	28	Arbitration scheme 1'b0: Fast Arbitration – used when EPL datapath frequency is the highest in the chip 1'b1: Slow Arbitration – used when EPL datapath is slower frequency and do not want to buffer up header data before arbitrating.	RW	1
DR	27	Disable Receive RS. This will stop accepting data from the MAC.	RW	0
DT	26	Disable Transmit RS.	RW	0
FS	25	Force Sequence Ordered Set Note: Cleared when FSIG is sent and will also cause FS bit to be asserted in PCS_IP Register	RW	0
FR	24	Force Remote Fault. Will force transmission of remote fault symbol continuously.	RW	0
FL	23	Force Local Fault. Will force transmission of local fault symbol continuously.	RW	0
EL	22	Enabling sending remote fault in response to RX link being down	RW	0
EF	21	Enable sending of remote faults on RX and also allow the disabling of TX channel when 4 or more RF seen	RW	0
RI	20	Invert RX lane ordering (L3 – L0) In 1 lane mode this receives all data on lane 3 instead of lane 0	RW	0
TI	19	Invert TX lane ordering (L3-L0) In 1 lane mode this sends all data out on lane 3 instead of lane 0	RW	0
DE	18	Enables the deficit idle count. The DIC counter allows an average of the programmed IFG, usually taken as 12, while forcing alignment of the start of frame to lane zero.	RW	0
II	17	Ignore inter-frame gap errors. (Recommend setting this bit, especially in single serdes mode.)	RW	0
IP	16	Ignore Preamble Errors (Recommend setting this bit, especially in single serdes mode.)	RW	0



**Table 145. PCS\_CFG\_1 [1..24] (Continued)**

ID	15	Ignore Data Errors. These are non-data characters found within the frame - bounded by  S  and  T	RW	0
IA	14	Ignore All RX errors	RW	0
IF	13:8	Programmable inter-frame gap (6b – 0-63B) Transmit only.	RW	0xC
RSVD	7:5	Reserved. Set to 0.	RV	0
SP	4	Enable support of shorter preamble in 10M/100M/1G mode only. Do not set this option in 10G mode.	RW	0
LF	3:0	LFSR seed, used to randomize /K/R/A characters in 10G mode. Must be non-zero; 0xA works well.	RW	0xA

*Note:* Bits: 14:17 are used for filtering out “garbage.” This garbage is not counted, A packet that cannot be initially resolved will not be counted in the Ethernet counters as a bad packet.

**Table 146. CS\_CFG\_2 [1..24]**

Name	Bit	Description	Type	Default
LF	23:0	Local fault value. The default value is required for compliance to 802.3ae.	RW	x000001
RSVD	31:24	Reserved. Set to 0.	RV	0

**Table 147. PCS\_CFG\_3 [1..24]**

Name	Bit	Description	Type	Default
RF	23:0	Remote fault value The default value is required for compliance to 802.3ae.	RW	x000002
RSVD	31:24	Reserved. Set to 0.	RV	0

**Table 148. PCS\_CFG\_4 [1..24]**

Name	Bit	Description	Type	Default
FSIGTX	23:0	Transmit FSIG value	RW	x000000
RSVD	31:24	Reserved. Set to 0.	RV	0

**Table 149. PCS\_CFG\_5 [1..24]**

Name	Bit	Description	Type	Default
FSIGRX	23:0	Received FSIG value	RO	X000000
RSVD	31:24	Reserved. Set to 0.	RV	0



**Table 150. PCS\_IP [1..24]**

Name	Bit	Description	Type	Default
Fault change	14	Indicates that there was a local fault or remote fault status change on the line. Read the LF or RF bit to determine the current status.	CR	0
Link Up	13	This bit reflects the current status of the link.  If this bit is set, then the link is in good working order, i.e. signal is detected (SERDES Status[SD]), symbol locked (SERDES Status[SL]) and lanes are aligned (PCS Status[LA]).  Hysteresis on this signal is controlled by register SERDES_CONTROL_3	RO	0
Link went up	12	Link transitioned from being down to being up	CR	0
Link went down	11	Link transitioned from being up to being down	CR	0
OV3	10	PCS FIFO overflow Lane D [Note: should be masked for single SerDes interfaces 9-24.]	CR	0
OV2	9	PCS FIFO overflow Lane C [Note: should be masked for single SerDes interfaces 9-24.]	CR	0
OV1	8	PCS FIFO overflow Lane B [Note: should be masked for single SerDes interfaces 9-24.]	CR	0
OV0	7	PCS FIFO overflow Lane A	CR	0
LA	6	Lanes Mis-Aligned Should be masked in 1 lane mode and for interfaces 9-24.	CR	0
FSIG Sent	5	FSIG Sent	CR	0
RS	4	Remote fault sent	CR	0
LS	3	Local fault sent	CR	0
FD	2	FSIG detected	CR	0
RD	1	Remote Fault Detected. This is a status bit, not an interrupt bit. The switch set this bit when at least 4 RF symbols are received from the line within 128 cycles. The switch reset this bit when no RF symbols are received within 128 cycles.	RO	0
LD	0	Local Fault Detected. This is a status bit, not an interrupt bit. The switch set this bit when at least 4 LF symbols are received from the line within 128 cycles. The switch reset this bit when no LF symbols are received within 128 cycles.	RO	0
RSVD	31:15	Reserved. Set to 0.	RV	0

*Notes:*

1. Since the status register is sticky, many of the status errors bits will naturally be asserted after reset. Once the link is up, this register should be read to clear out the "old" reset values and allow new errors to be caught.



2. In 1 lane mode the Autoneg Receive, UD, DU and LU bits are based on only the 1 active lane (could be lane 0 - default or lane 3 if lanes are reversed)

**Table 151. PCS\_IM [1..24]**

Name	Bit	Description	Type	Default
Interrupt Mask	14:0	1 – Mask interrupt 0 – Do not mask interrupt  Note that bits 0, 1 and 13 correspond to status bits in the PCS_IP register and shall remain masked.	RW	X7FFF
RSVD	31:15	Reserved. Set to 0.	RV	0

**Table 152. PACING\_PRI\_WM [0..7] [1..24]**

Name	Bit	Description	Type	Default
Pace_WM[i]	24:0	Watermark (in 4 byte words). For a frame of IEEE 802.1p, the WM is checked against the IFGS. If the IFGS has exceeded this WM, then the frame is held on transmission until the IFGS has been decremented to this WM.*  In 1 lane mode will increment counter by 4B for each cycle actual data is sent. One can think of the counter to be an effectively 23b byte counter. 1 lane 1/10 and 1/100 mode operation will be ignored and will make IFGS ineffective for these 2 modes.	RW	x0000
RSVD	31:25	Reserved. Set to 0.	RV	0

*Note:*

At the link level, frames can no longer be re-ordered. So if the scheduler picks a frame to transmit that can't go because of the IFGS and the frame priority, it is not acceptable for a higher priority frame behind it to be transmitted first even if it meets the watermark check in EPL\_PACE\_PRI\_WM[i].

The index used [0..7] is retrieved from the switch priority to egress priority table TXPRI\_MAP regardless if the priority regeneration is enabled or not.

**Table 153. PACING\_RATE [1..24]**

Name	Bit	Description	Type	Default
Pacing Rate	7:0	Pacing Rate controls the rate to a degree of 1 in 256. 0x00 – Pacing is not enabled 0x01 – Pacing is 1/256 the bandwidth. ... 0xFF – Pacing is 255/256 the bandwidth	RW	x00
RSVD	31:8	Reserved. Set to 0.	RV	0

**Table 154. PACING\_STAT [1..24]**

Name	Bit	Description	Type	Default
IFGS	24:0	IFGS (calculated in bytes) from each frame accumulated from frame to frame.	RO	x0000
RSVD	31:25	Reserved. Set to 0.	RV	0



### 5.8.3 MAC Registers

**Table 155. MAC\_CFG\_1 [1..24]**

Name	Bit	Description	Type	Default
Min Frame	29:24	Min Frame Size in words	RW	0x10
Max Frame	23:12	Max Frame Size in words	RW	0x180
CRC start	11:6	Number of words to skip before starting the CRC.	RW	0
Header Offset	5:0	Number of words to skip before the next 16 bytes is sent from the EPL to the frame processor.	RW	0
RSVD	31:30	Reserved. Set to 0.	RV	0

*Note:* If a frame violates the min size frame, the following frame on that port will be corrupted as well.

**Table 156. MAC\_CFG\_2 [1..24]**

Name	Bit	Description	Type	Default
VLAN Ether Type	31:16	This register is used when a new VLAN tag is added in front of an existing VLAN tag of type 8100. It defines the new Ethernet type to use for this new VLAN tag. If there is no VLAN tag x8100 present in the frame, then the Ethernet type used will be x8100 regardless of the content of this register.	RW	x8100
Pad Min Size	7	Pad frames that violate the Min Size to Min Size. If the frame entered the switch $\geq$ Min Size with a good CRC, and it has had a tag removed in the switch, it is padded to Min Size with a good CRC. If the frame entered the switch $<$ Min Size and it cannot be discarded, then it leaves the switch padded to Min Size with a forced bad CRC.	RW	1
PHY Error Discard	6	Mark the frame as discard eligible if an illegal character has been detected by the PHY during packet reception.	RW	1
Max Len Discard	5	Mark the frame as discard eligible if the frame is above the maximum size. Once the length of a frame has exceeded Max Frame, its additional data is discarded at the RX MAC regardless of the state of this bit.	RW	1
RX CRC Discard	4	Mark the frame as discard eligible if the frame received as an RX CRC error.	RW	1
Min Frame Discard	3	Mark the frame as discard eligible if the frame is smaller than the minimum size configured.	RW	1
Disable RX Pause	2	0 - Parse RX Pause. The MAC will parse incoming RX pause frames, pausing transmission on the associated Tx port for the specified time. 1 - Do not parse RX Pause. Stream the pause frame into the switch, as a normal multicast frame, where it is subject to further processing.	RW	1

**Table 156. MAC\_CFG\_2 [1..24] (Continued)**

Disable TX MAC	1	When set to 1, will stop transmission of frames from this port. Packets still drain from the switch element. The link transmits idles and stays in sync.	RW	0
Disable RX MAC	0	When set to 1, this idles the RX MAC on the next frame boundary. All incoming packets are then discarded and are thus prevented from entering the switch.	RW	0
RSVD	15:8	Reserved. Set to 0.	RV	0

*Notes:*

1. Marking a frame as discard eligible will force the frame to be dropped in store and forward mode and may cause the frame to be dropped in the cut-through mode. If the frame is not dropped and actually forwarded in the cut-through mode, then the frame will be transmitted with a corrupted CRC
2. A runt frame is flagged as an error to the frame processor and S.E. as soon as it is discovered.
3. In store and forward mode, all error frames are discarded before being sent. In cut-through mode, a packet is discarded if the error "catches up" with the head of the packet.
4. Overflow always discards. It is not a programmable option.
5. It's not a valid packet if you overflow on the first word.
6. If Min frame is set to 64 bytes, and Min Frame Discard is enabled, then garbage inputs will never do more harm than result in a first good frame being discarded on the same port as the last bad frame. If in addition, the data-sheet specs a higher Total Switch Max Frame Rate than (Ports\*64 bytes), then Min Frame can be reduced until  $(1/\text{Min Frame}) * \text{Ports} = \text{Total Switch Max Frame Rate}$ . If MAC\_CFG\_2[Min Frame discard] is off, but MAC\_CFG\_2[Pad to Min Size] is on, then the switch will never discard more than one good frame after the last bad frame per port. However, if Min Frame Discard is off and Pad to Min Size is not enabled, then all guarantees of frame discard are off except that the switch should not get into an illegal state.

**Table 157. MAC\_CFG\_3 [1..24]**

Name	Bit	Description	Type	Default
Pause Value	15:0	Number of 512 bit times that the link partner needs to Pause.	RW	xFFFF
RSVD	31:16	Reserved. Set to 0.	RV	0

**Table 158. MAC\_CFG\_4 [1..24]**

Name	Bit	Description	Type	Default
Time to resend Pause Value	15:0	Pause time before the TX resends the pause ON frame. Should be set about 20% lower than Pause Value to ensure that the port remains paused. To account for a lost or corrupted PAUSE frame, the time value should be divided by two, and by three to account for back-to-back lost PAUSE frames.	RW	xFFFF
RSVD	31:16	Reserved. Set to 0.	RV	0



Table 159. MAC\_CFG\_5 [1..24]

Name	Bit	Description	Type	Default
MSB of MA	15:0	Most significant 16 bits of the MAC address. Used as a source address when a PAUSE frame is transmitted.	RW	0
RSVD	31:16	Reserved. Set to 0.	RV	0

Table 160. MAC\_CFG\_6 [1..24]

Name	Bit	Description	Type	Default
LSB of MA	31:0	Least significant 32 bits of the MAC address. Used as a source address when a PAUSE frame is transmitted.	RW	0

Table 161. TX\_PRI\_MAP\_1 [1..24]

Name	Bit	Description	Type	Default
Pri7 Regen	31	Indicates if the Egress Priority shall be replace (1) or not (0) for switch priority 7.	RW	0x0
Pri7	30:28	Map Switch Priority 7 to Egress Priority	RW	0x7
Pri6 Regen	27	Indicates if the Egress Priority shall be replace (1) or not (0) for switch priority 6.	RW	0x0
Pri6	26:24	Map Switch Priority 6 to Egress Priority	RW	0x6
Pri5 Regen	23	Indicates if the Egress Priority shall be replace (1) or not (0) for switch priority 5.	RW	0x0
Pri5	22:20	Map Switch Priority 5 to Egress Priority	RW	0x5
Pri4 Regen	19	Indicates if the Egress Priority shall be replace (1) or not (0) for switch priority 4.	RW	0x0
Pri4	18:16	Map Switch Priority 4 to Egress Priority	RW	0x4
Pri3 Regen	15	Indicates if the Egress Priority shall be replace (1) or not (0) for switch priority 3.	RW	0x0
Pri3	14:12	Map Switch Priority 3 to Egress Priority	RW	0x3
Pri2 Regen	11	Indicates if the Egress Priority shall be replace (1) or not (0) for switch priority 2.	RW	0x0
Pri2	10:8	Map Switch Priority 2 to Egress Priority	RW	0x2
Pri1 Regen	7	Indicates if the Egress Priority shall be replace (1) or not (0) for switch priority 1.	RW	0x0
Pri1	6:4	Map Switch Priority 1 to Egress Priority	RW	0x1
Pri0 Regen	3	Indicates if the Egress Priority shall be replace (1) or not (0) for switch priority 0.	RW	0x0
Pri0	2:0	Map Switch Priority 0 to Egress Priority	RW	0x0

Table 162. TX\_PRI\_MAP\_2 [1..24]

Name	Bit	Description	Type	Default
Pri15 Regen	31	Indicates if the Egress Priority shall be replace (1) or not (0) for switch priority 15.	RW	0x0
Pri15	30:28	Map Switch Priority 15 to Egress Priority	RW	0x7

**Table 162. TX\_PRI\_MAP\_2 [1..24] (Continued)**

Pri14 Regen	27	Indicates if the Egress Priority shall be replace (1) or not (0) for switch priority 14.	RW	0x0
Pri14	26:24	Map Switch Priority 14 to Egress Priority	RW	0x6
Pri13 Regen	23	Indicates if the Egress Priority shall be replace (1) or not (0) for switch priority 13.	RW	0x0
Pri13	22:20	Map Switch Priority 13 to Egress Priority	RW	0x5
Pri12 Regen	19	Indicates if the Egress Priority shall be replace (1) or not (0) for switch priority 12.	RW	0x0
Pri12	18:16	Map Switch Priority 12 to Egress Priority	RW	0x4
Pri11 Regen	15	Indicates if the Egress Priority shall be replace (1) or not (0) for switch priority 11.	RW	0x0
Pri11	14:12	Map Switch Priority 11 to Egress Priority	RW	0x3
Pri10 Regen	11	Indicates if the Egress Priority shall be replace (1) or not (0) for switch priority 10.	RW	0x0
Pri10	10:8	Map Switch Priority 10 to Egress Priority	RW	0x2
Pri9 Regen	7	Indicates if the Egress Priority shall be replace (1) or not (0) for switch priority 9.	RW	0x0
Pri9	6:4	Map Switch Priority 9 to Egress Priority	RW	0x1
Pri8 Regen	3	Indicates if the Egress Priority shall be replace (1) or not (0) for switch priority 8.	RW	0x0
Pri8	2:0	Map Switch Priority 8 to Egress Priority	RW	0x0

**Table 163. MAC\_STATUS [1..24]**

Name	Bit	Description	Type	Default
TX Status	1	TX idle	RO	0
RX Status	0	RX idle	RO	0
RSVD	31:2	Reserved. Set to 0.	RV	0

**Table 164. MAC\_IP [1..24]**

Name	Bit	Description	Type	Default
FE	10	Fabric error. This bit is set whenever the enable signal from the switch array becomes deasserted regardless where we are in the frame or if there is any data received at all. This could only happen if the crossbar becomes congested. It is not expected to happen if the chip is operated in normal conditions.	CR	0
PE	9	RX Pause Enable de-asserted (for debug purposes – should not be observed in normal operation)	CR	0
TU	8	TX underflow	CR	0
TR	7	TX CRC without RX CRC error	CR	0
TC	6	TX CRC error (inclusive of TR)	CR	0
HE	5	RX PHY error	CR	0



**Table 164. MAC\_IP [1..24] (Continued)**

PO	4	RX Pause Overflow. Note that this is for debug purpose at the unit level and cannot happen at the system level.	CR	0
JE	3	RX Oversized error	CR	0
CE	2	RX CRC error	CR	0
OE	1	Overflow error. This bit is set if a data word has been discarded because either the fabric or the frame control back pressured and data was actually lost. This could only happen once per frame.	CR	0
RE	0	RX Runt error	CR	0
RSVD	31:5	Reserved. Set to 0	RV	0

*Note:* The MAC and SERDES and PCS IP registers are or'd together to form a hardware EPL interrupt. This is visible at the per-port level interrupts.

**Table 165. MAC\_IM [1..24]**

Name	Bit	Description	Type	Default
Mask Interrupts	10:0	For each interrupt: 1 – Mask Interrupt 0 – Do not mask interrupt	RW	0x7FF
RSVD	31:11	Reserved. Set to 0.	RV	0

**Table 166. PL\_INT\_DETECT [1..24]**

Name	Bit	Description	Type	Default
EPL_IP_3	2	There is an interrupt in MAC_IP	RO	0
EPL_IP_2	1	There is an interrupt in PCS_IP	RO	0
EPL_IP_1	0	There is an interrupt in SERDSE_IP	RO	0
RSVD	31:3	Reserved. Set to 0.	RV	0

**Table 167. EPL\_LED\_STATUS [1..24]**

Name	Bit	Description	Type	Default
TT	4	TX Port Transmitting – TX port transmitting data	CR	0
RR	3	RX Port Receiving – RX port receiving data	CR	0
RL	2	RX Port Status – RX port has link up	CR	0
PR	1	Port Remote Fault – port has or has sent a remote fault	CR	0
TT	4	TX Port Transmitting – TX port transmitting data	CR	0
RR	3	RX Port Receiving – RX port receiving data	CR	0



**Table 167. EPL\_LED\_STATUS [1..24] (Continued)**

RL	2	RX Port Status – RX port has link up	CR	0
PR	1	Port Remote Fault – port has or has sent a remote fault	CR	0
PS	0	Port Status - port has link sync error or no signal	CR	0

*Note:*

This register is made clear on read for the LED state machine. It is possible for the CPU to read this as well, in which case the results are cleared independent of the LED state machine. These fields are not “Or-d” into a standard interrupt detect chain.

**Table 168. STAT\_EPL\_ERROR1[1..24]**

Name	Bit	Description	Type	Default
Overflow Count	15:8	Number of overflowed frames (RX) that were discarded before any information was sent to the FCU	RO	0
Underflow Count	7:0	Number of frame that were terminated early or discarded due to underflow in the TX	RO	0
RSVD	31:16	Reserved. Set to 0.	RV	0

**Table 169. STAT\_EPL\_ERROR2[1..24]**

Name	Bit	Description	Type	Default
Corrupted Frame Count	15:0	Count the number of frames that were received with good CRC but transmitted with a bad CRC by this port because there was an error detected in the message array memory.	RO	0
RSVD	31:16	Reserved. Set to 0.	RV	0

**Table 170. STAT\_RX\_JABBER [1..24]**

Name	Bit	Description	Type	Default
Jabber Count	15:0	Number of frames received in which frame size > MaxFrame and the CRC is invalid. Writing into this register will reset the register to 0.	RWC	0
RSVD	31:16	Reserved. Set to 0.	RV	0

**Table 171. STAT\_TX\_CRC [1..24]**

Name	Bit	Description	Type	Default
TX CRC Errors	31:0	Number of frames transmitted with CRC errors. Part of the RMON counters, even though they are physically located in the MAC. Writing into this register will reset the register to 0.	RWC	0



Table 172. STAT\_TX\_PAUSE [1..24]

Name	Bit	Description	Type	Default
TX Pause	31:0	Number of Pause frames transmitted by the MAC. Part of the RMON counters, even though they are physically located in the MAC. Writing into this register will reset the register to 0.	RWC	0

Table 173. STAT\_TX\_BYTECOUNT [1..24]

Name	Bit	Description	Type	Default
TX Byte Count	63:0	Number of bytes transmitted (see STAT_TxOctets in the statistics section). Writing into this register will reset the register to 0.	RWC	0

## 5.8.4 Scan Registers

Table 174. SCAN\_FREQ\_MULT

Name	Bit	Description	Type	Default
MGMT2SCAN	7:0	CLK_CPU divider	RW	0
RSVD	31:8	Reserved. Set to 0.	RV	0

Table 175. SCAN\_CTRL

Name	Bit	Description	Type	Default
Shift Count	6:2	Number of bits to shift	RW	0
Test Mode	1	Select group of scan chain: 0 = scan chains 0-15 1 = scan chains 16-31	RW	0
Enable Capture	0	Execute capture (self clear after capture done)	RW	0
RSVD	31:7	Reserved. Set to 0.	RV	0

Table 176. SCAN\_SEL

Name	Bit	Description	Type	Default
Select	31:0	Select scan chain. This is a one hot encoding (1 << "n").	RW	0

Table 177. SCAN\_DATA\_IN

Name	Bit	Description	Type	Default
Data	31:0	Data received from scan chain	RO	0



**Table 178. SCAN\_DATA\_OUT**

Name	Bit	Description	Type	Default
Data	31:0	Data sent to scan chain	RW	0



## 6.0 Signal, Ball, and Package Descriptions

### 6.1 Package Overview

The FM2112 uses the following package:

- Overall package dimensions of 32mm x 32mm
- Flip-chip-based BGA package, with attached heat spreader
  - 31 balls on a side (ball pitch of 1.0mm)
  - 897 total balls in use

### 6.2 Power Mapping

Figure 23 shows a visual mapping of the power pins for the device.

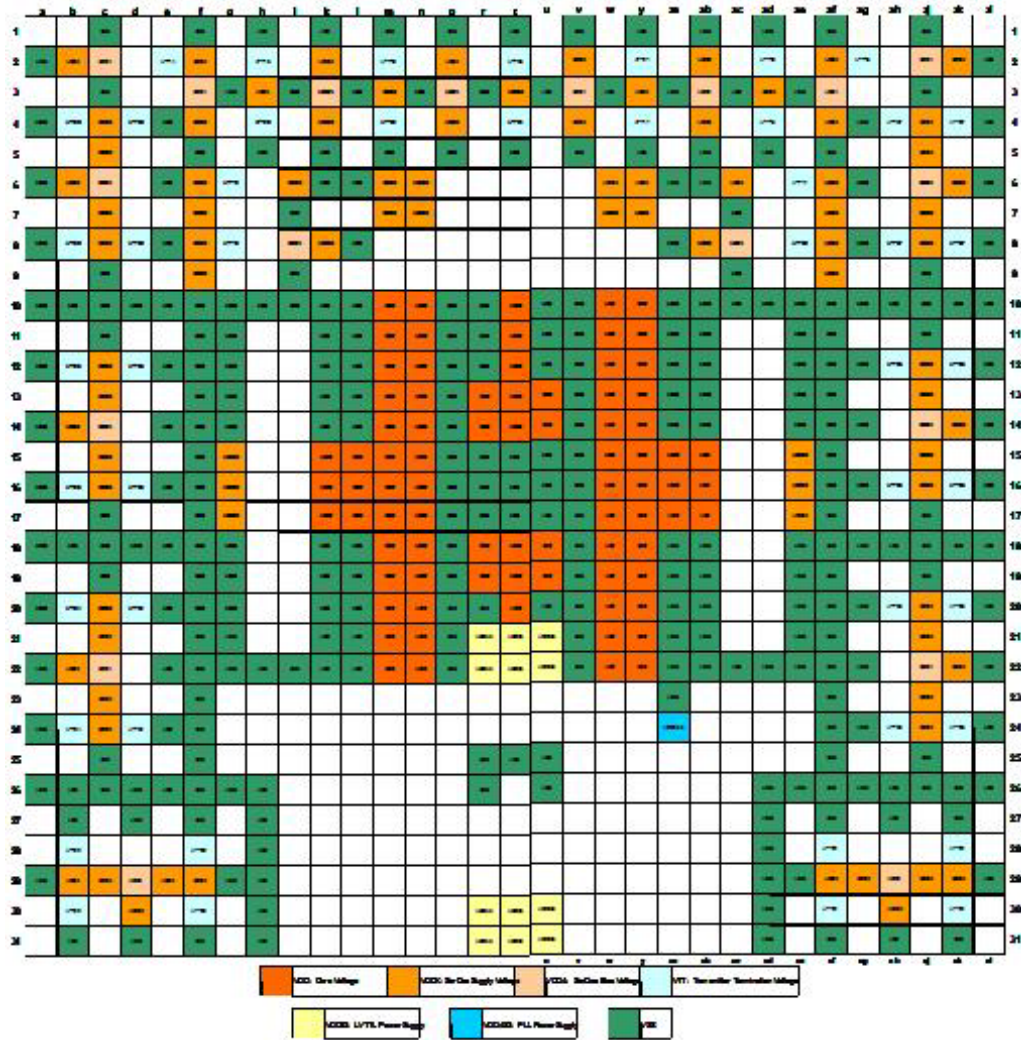

Figure 23. Power Mapping for the FM2112 897-ball BGA Package (bottom view)



Note: Consult the FM2112 Design and Layout Guide (Intel® document number: FM2112-DG) for specific information on filtering strategies.

### 6.3 Interface Mapping

Figure 24 shows a visual mapping of the interface pins for the device.

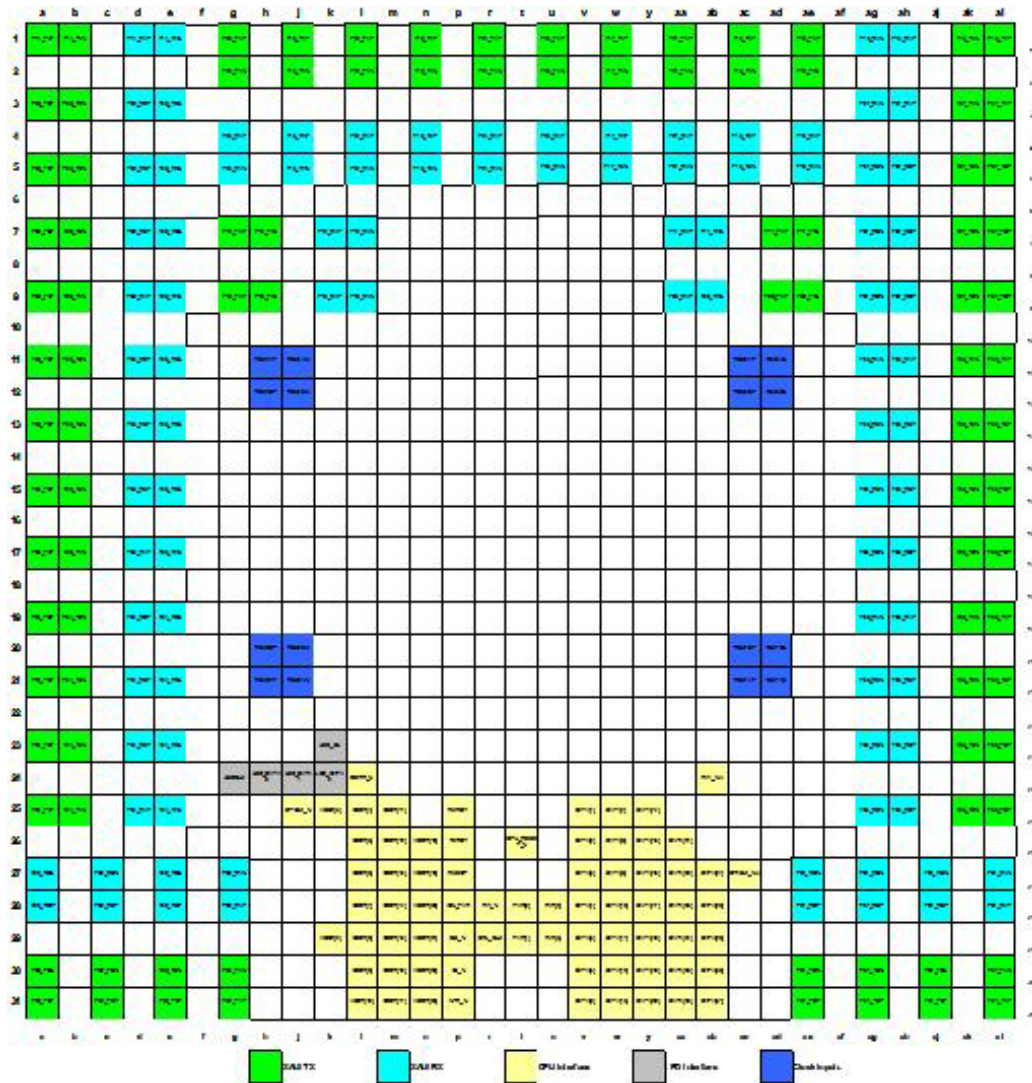

Figure 24. Interface Mapping (bottom view)

### 6.4 Signal Descriptions

This section describes the signals for the device, providing details on the name, ball assignment, type, and use of each signal.



### 6.4.1 FM2112 Signals

**Table 179. FM2112 XAUI Signal Pins**

Signal Name	I/O	Type	Description
Pnn_RAN [1:24]	CML	Input	Differential receive inputs for channel A -- Complement
Pnn_RAP [1:24]	CML	Input	Differential receive inputs for channel A -- True
Pnn_RBN [1:8]	CML	Input	Differential receive inputs for channel B -- Complement
Pnn_RBP [1:8]	CML	Input	Differential receive inputs for channel B -- True
Pnn_RCN [1:8]	CML	Input	Differential receive inputs for channel C -- Complement
Pnn_RCP [1:8]	CML	Input	Differential receive inputs for channel C -- True
Pnn_RDN [1:8]	CML	Input	Differential receive inputs for channel C -- Complement
Pnn_RDP [1:8]	CML	Input	Differential receive inputs for channel C -- True
Pnn_TAN [1:24]	CML	Output	Differential transmit outputs for channel A - Complement
Pnn_TAP [1:24]	CML	Output	Differential transmit outputs for channel A - True
Pnn_TBN [1:8]	CML	Output	Differential transmit outputs for channel B - Complement
Pnn_TBP [1:8]	CML	Output	Differential transmit outputs for channel B - True
Pnn_TCN [1:8]	CML	Output	Differential transmit outputs for channel C - Complement
Pnn_TCP [1:8]	CML	Output	Differential transmit outputs for channel C - True
Pnn_TDN [1:8]	CML	Output	Differential transmit outputs for channel D - Complement
Pnn_TDP [1:8]	CML	Output	Differential transmit outputs for channel D - True
RREF [1:24]	Analog	Ref-erence	Reference resistor pad. Connect a 1.2KΩ resistor from each RREF pad to 1.2V V <sub>DDX</sub> or a 1.0KΩ resistor from each RREF to 1.0V V <sub>DDX</sub> . Provides a reference current for the driver and equalization circuits.

*Note:* There are twenty-four XAUI interfaces in total. The “nn” in the above signal names represent a port number from 1 to 24.

**Table 180. FM2112 High-Speed Clock Signal Pins**

Signal Name	I/O	Type	Description
RCK1AN	CML (1) LVDS LVPECL	Input	Differential Reference Clock A for Ports 1, 3, 5, 7, 9, 11 Complement
RCK1AP	CML (1) LVDS LVPECL	Input	Differential Reference Clock A for Ports 1, 3, 5, 7, 9, 11 True
RCK1BN	CML (1) LVDS LVPECL	Input	Differential Reference Clock B for Ports 1, 3, 5, 7, 9, 11 Complement



Table 180. FM2112 High-Speed Clock Signal Pins (Continued)

RCK1BP	CML (1) LVDS LVPECL	Input	Differential Reference Clock B for Ports 1, 3, 5, 7, 9, 11 True
RCK2AN	CML (1) LVDS LVPECL	Input	Differential Reference Clock A for Ports 2, 4, 6, 8, 10, 12 Complement
RCK2AP	CML (1) LVDS LVPECL	Input	Differential Reference Clock A for Ports 2, 4, 6, 8, 10, 12 True
RCK2BN	CML (1) LVDS LVPECL	Input	Differential Reference Clock B for Ports 2, 4, 6, 8, 10, 12 Complement
RCK2BP	CML (1) LVDS LVPECL	Input	Differential Reference Clock B for Ports 2, 4, 6, 8, 10, 12 True
RCK3AN	CML (1) LVDS LVPECL	Input	Differential Reference Clock A for Ports 13, 15, 17, 19, 21, 23 Complement
RCK3AP	CML (1) LVDS LVPECL	Input	Differential Reference Clock A for Ports 13, 15, 17, 19, 21, 23 True
RCK3BN	CML (1) LVDS LVPECL	Input	Differential Reference Clock B for Ports 13, 15, 17, 19, 21, 23 Complement
RCK3BP	CML (1) LVDS LVPECL	Input	Differential Reference Clock B for Ports 13, 15, 17, 19, 21, 23 True
RCK4AN	CML (1) LVDS LVPECL	Input	Differential Reference Clock A for Ports 14, 16, 18, 20, 22, 24 Complement
RCK4AP	CML (1) LVDS LVPECL	Input	Differential Reference Clock A for Ports 14, 16, 18, 20, 22, 24 True
RCK4BN	CML (1) LVDS LVPECL	Input	Differential Reference Clock B for Ports 14, 16, 18, 20, 22, 24 Complement
RCK4BP	CML (1) LVDS LVPECL	Input	Differential Reference Clock B for Ports 14, 16, 18, 20, 22, 24 True

*Note:* These pins are AC coupled and are compatible with the stated IO. For LVDS IO a 2K resistor is required between the lines on the driver side of the isolation capacitors



**Table 181. FM2112 CPU Interface Signal Pins**

Signal Name	I/O	Type	Description
CPU_CLK	Input	LVTTTL	Clock for Bus Interface (maximum frequency is 100MHz)
CS_N	Input	LVTTTL	Chip select. Active low. Enables the FM2112 to act on an incoming request. Allows multiple devices with the same address space to share the bus. Two uses for the signal: (1) To enable the start of a new request – to qualify AS_N; (2) To qualify the outputs DATA and DTACK_N. When asserted, the two outputs are tri-stated. (Pull-up recommended on board.)
ADDR[23:2]	Input	LVTTTL	Address Bus. Address must be driven whenever AS_N asserted.
DATA[31:0]	In/Out	LVTTTL	Bi-directional data bus. Must be driven when AS_N and RW_N (read) are asserted. Will be driven on a write when DTACK_N is asserted. The DATA bus is undriven when the device is coming out of reset. (Pull-down recommended on board.)
PAR[3:0]	In/Out	LVTTTL	Even parity for each byte of data. PAR must be driven when AS_N and RM_N (read) are asserted and Ignore_Parity strapping pin is not asserted. PAR will be driven on a write when DTACK_N is asserted. (Pull-down recommended on board.)
AS_N	Input	LVTTTL	Address Strobe. Indicates the start of a valid transaction on the bus. Active Low. Must be inactive after reset. (Pull-up recommended on board.)
RW_N	Input	LVTTTL	Read/Write. Indicates when a read (active high) or write (active low) transaction is being requested. Determines which device drives the data bus. Polarity can be switched through the RW_INV strapping pin.
RW_INV	Input	LVTTTL	Inverts RW_N pin. When connected to ground, then read is active high while write is active low. Conversely, when connected to VDD33, read is active low while write is active high.
DTACK_N	Output	LVTTTL	Data transfer acknowledge. Indicates the completion of a data transfer. At the termination of a request, this signal is actively driven inactive for 1 cycle and then tri-stated. The pin is tri-stated when the device is coming out of reset. Pull-up or pull-down should be added to board, according to whether DTACK_INV is asserted.
DTACK_INV	Input	LVTTTL	Strap pin. Inverts sense of DTACK_N. If connected to ground, then DTACK_N is active low. If connected to VDD33, then DTACK_N is active high.
DERR_N	Output	LVTTTL	Data error occurred; transaction must be aborted and was not completed. Indicates write data parity errors. Only asserted (and valid) when DTACK_N asserted. Tri-stated otherwise.



**Table 181. FM2112 CPU Interface Signal Pins (Continued)**

CPU_RESET_N	Input	LVTTTL	Hard reset for Management block domain. Reserved for Intel®. Connect to an external pull-up.
INTR_N	Output	SE, Open Drain	Synchronous interrupt. Indicates an internal error. The global interrupt status register must be checked to ascertain the source of the problem. Active Low. (Pull-up recommended on board.)
IGNORE_PARITY	Input	LVTTTL	Disables parity checking on incoming write data.

**Table 182. FM2112 DMA Pins**

Signal Name	I/O	Type	Description
TXRDY_N	Output	LVTTTL	Transmit queue is ready to receive (connected to Pause channel)
RXRDY_N	Output	LVTTTL	Receive queue has data to send to CPU
RXEOUT	Output	LVTTTL	End of frame indication (instructs DMA controller to begin storing data to a new frame descriptor)

**Table 183. FM2112 SPI Interface Signal Pins**

Signal Name	I/O	Type	Description
SPI_CLK	Output	LVTTTL	SPI clock
SPI_CS_N	Output	LVTTTL	SPI chip select (active low)
SPI_SI	Input	LVTTTL	Serial data input
SPI_SO	Output	LVTTTL	Serial data output

**Table 184. FM2112 LED Interface Signal Pins**

Signal Name	I/O	Type	Description
LED_CLK	Output	LVTTTL	Provides a continuous clock synchronous to the serial data stream output on the LED_DATA pin. Tri-stated with LED_EN.
LED_DATA0	Output	LVTTTL	Serial bit stream from ports 1-8, and 0. Ports 1-8 are driven first, and then the CPU port (port 0) is driven. Asserted on the negative edge of LED_CLK. Tri-stated with LED_EN.
LED_DATA1	Output	LVTTTL	Serial bit stream from ports 9-16. Data is driven on the negative edge of LED_CLK and is valid on the rising edge of CLK_LED. Mode 1 inverts the polarity of the data. Tri-stated with LED_EN.
LED_DATA2	Output	LVTTTL	Serial bit stream from ports 17-24. Data is driven on the negative edge of LED_CLK and is valid on the rising edge of CLK_LED. Mode 1 inverts the polarity of the data. Tri-stated with LED_EN.
LED_EN	Output	LVTTTL	Used in Mode1 as the latch enable for the shift register chain. In Mode 0, this signal is not used and should be left unconnected. Asserted when LED_CLK is low, coincident with the 36 <sup>th</sup> bit (last bit in LED data stream). Tri-stated with LED_EN.



**Table 185. FM2112 JTAG Interface Signal Pins**

Signal Name	I/O	Type	Description
TCK	Input	LVTTTL	JTAG Clock
TDI	Input	LVTTTL	JTAG Input Data. Internally pulled up.
TMS	Input	LVTTTL	JTAG Test Mode. Internally pulled up.
TRST_N	Input	LVTTTL	JTAG Reset Pin. Internally pulled up.
TDO	Output	LVTTTL	JTAG Data Out

*Note:* When not using the JTAG interface, either drive the TCK pin with an external clock, or drive the TRST\_N pin low. Conversely, when using the JTAG interface assert TRST\_N along with chip reset to ensure proper reset of the JTAG interface prior to use.

**Table 186. FM2112 Miscellaneous Signal Pins**

Signal Name	I/O	Type	Description
CHIP_RESET_N	Input	LVTTTL	Hard reset for the entire chip.
CONT_EN	Input	LVTTTL	SerDes continuity test enable.
CONT_OUT	Output	LVTTTL	SerDes continuity test output.
DIODE_IN DIODE_OUT	Sense	LVTTTL	Die temperature is measured with a standard temperature sensing diode. Both terminals of the diode are exposed through the die to the package.
EEPROM_EN	Input	LVTTTL	EEPROM enable. Enabled when high. Pull low to bypass EEPROM and boot from processor.
AUTOBOOT	Input	LVTTTL	When asserted, the BOOT FSM starts automatically after RESET is de-asserted, initializing the chip according to the content of fusebox. Returns control to the CPU Interface after the initialization is completed. Pull low to boot from processor.
FH_PLL_REFCLK	Input	LVTTTL	Refclock input to frame handler PLL
FH_PLL_CLKOUT	Output		Reserved for Intel® use an should be left unconnected.
TESTMODE	Input		Reserved for Intel® use. Must be pulled down in normal operation.

**Table 187. List of No Connects and Unpopulated Ball Locations**

Pins	Description
AC13, AC14, AC15, AC16, AC17, AC18, AC19 AD13, AD14, AD15, AD16, AD17, AD18, AD19 P13, P14, P15, P16, P17, P18, P19 H13, H14, H15, H16, H17, H18, H19 J13, J14, J15, J16, J17, J18, J19 M8, M9, M23, M24 N8, N9, N23, N24 P8, P9, P23, P24 R8, R9, R23, R24 T8, T9, T23, T24 U8, U9, U23, U24 V8, V9, V23, V24 W8, W9, W23, W24 Y8, Y9, Y23, Y24	Ball grid locations that are not populated with solder balls
AB23, AC23, AC28, AC29, AC30, AC31, AD23, R27, AE23, AE24, T27, G25, U27, H25, J26, J28, J29, K26, K27, K28	No connects

**Table 188. FM2112 Power Supply Signal Descriptions**

Signal Name	Quantity	Type	Description
V <sub>SS</sub>	305	Power	Ground, for Core and I/O
V <sub>DD</sub>	80	Power	Core VDD (1.2 V)
V <sub>DD33</sub>	12	Power	I/O VDD (3.3 V), for LVTTTL
V <sub>DDA33</sub>	1	Power	PLL analog supply
V <sub>DDA</sub>	18	Power	SerDes bias voltage
V <sub>DDX</sub>	85	Power	SerDes supply voltage
V <sub>TT</sub>	48	Power	TX termination voltage, which can be used to adjust the common mode voltage and swing of TX outputs

## 6.4.2 Recommended Connections

Ideally the following power supplies should be on the board containing the FM2112:

- A 1.2 V source to supply the core (V<sub>DD</sub>)
- A 1.2 V or 1.0 V source to supply power to the SerDes (V<sub>DDX</sub>)
- A 1.2 V source to supply bias to the SerDes (V<sub>DDA</sub>)
- A 1.5 V typical source to terminate and set the common mode of the CML TX interface (V<sub>TT</sub>)
- A 3.3 V supply for the LVTTTL I/O signals (V<sub>DD33</sub>)
- A 3.3 V noise minimized source to supply the PLL (V<sub>DDA33</sub>)



### 6.4.2.1 Recommended Filtering

The power supply should be filtered both at the source of the power supply and local to the power supply balls on the FM2112. The power balls have been designed to take advantage of the space on the inside of the signal pins on the back side of the board for this purpose.

Note Consult the FM2112 Design and Layout Guide (Intel® document number: FM2112 DG) for specific information on filtering strategies.

### 6.4.2.2 Power Supply Sequencing

The FM2112 TTL I/Os use the 3.3V supply, but the internal logic in the switch controlling those I/Os uses the VDD supply. If the 3.3V is present on the part and the VDD is not, then the I/Os are in an unpredictable state. As an example, if a processor is attached to the FM2112 via the CPU bus and to a boot ROM on the same bus, then the fact that the FM2112 I/Os could be in an unknown state (if VDD is not present) may cause a boot problem. To solve this problem, ensure that VDD is applied before a general master reset is de-asserted to the main processor as this will ensure that the TTL I/Os are in a correct state. Another way to solve this problem would be to use tri-state buffers on the EBI bus.

The correct power sequencing is:

- Apply power to all components, including the switch
- De-assert master reset on board
- Optional de-assert reset on the switch (but not required at this stage)
- Processor boots (if processor present)
- Processor de-assert reset on the switch (if not done)
  - EBI clock must be present on the switch before the reset is deasserted (10 cycles good enough).

### 6.4.3 Ball Assignment

Table 189. Package Ball Assignment in Numerical Order

Pkg Ball	Signal Name	Pkg Ball	Signal Name	Pkg Ball	Signal Name
A1	P14_TAP	L16	VDD	AA31	DATA[26]
A2	VSS	L17	VDD	AB1	VSS
A3	P08_TDP	L18	VSS	AB2	VDDX
A4	VSS	L19	VSS	AB3	VDDA
A5	P08_TCP	L20	VSS	AB4	VDDX
A6	VSS	L21	VSS	AB5	VSS
A7	P08_TBP	L22	VSS	AB6	VSS
A8	VSS	L23	TESTMODE	AB7	P11_RAN



Table 189. Package Ball Assignment in Numerical Order (Continued)

A9	P08_TAP	L24	DERR_N	AB8	VDDX
A10	VSS	L25	ADDR[4]	AB9	P09_RAN
A11	P06_TDP	L26	ADDR[5]	AB10	VSS
A12	VSS	L27	ADDR[6]	AB11	VSS
A13	P06_TCP	L28	ADDR[7]	AB12	VSS
A14	VSS	L29	ADDR[8]	AB13	VSS
A15	P06_TBP	L30	ADDR[9]	AB14	VSS
A16	VSS	L31	ADDR[10]	AB15	VDD
A17	P06_TAP	M1	VSS	AB16	VDD
A18	VSS	M2	VTT18	AB17	VDD
A19	P04_TDP	M3	VDDX	AB18	VSS
A20	VSS	M4	VTT22	AB19	VSS
A21	P04_TCP	M5	VSS	AB20	VSS
A22	VSS	M6	VDDX	AB21	VSS
A23	P04_TBP	M7	VDDX	AB22	VSS
A24	VSS	M8	NO BALL	AB23	NC
A25	P04_TAP	M9	NO BALL	AB24	RW_INV
A26	VSS	M10	VDD	AB25	TCK
A27	P02_RDN	M11	VDD	AB26	DIODE_IN
A28	P02_RDP	M12	VDD	AB27	DATA[27]
A29	VSS	M13	VDD	AB28	DATA[28]
A30	P02_TDN	M14	VDD	AB29	DATA[29]
A31	P02_TDP	M15	VDD	AB30	DATA[30]
B1	P14_TAN	M16	VDD	AB31	DATA[31]
B2	VDDX	M17	VDD	AC1	P15_TAP
B3	P08_TDN	M18	VDD	AC2	P15_TAN
B4	VTT08	M19	VDD	AC3	VSS
B5	P08_TCN	M20	VDD	AC4	P15_RAP
B6	VDDX	M21	VDD	AC5	P15_RAN
B7	P08_TBN	M22	VDD	AC6	VDDX
B8	VTT08	M23	NO BALL	AC7	VSS
B9	P08_TAN	M24	NO BALL	AC8	VDDA
B10	VSS	M25	ADDR[11]	AC9	VSS
B11	P06_TDN	M26	ADDR[12]	AC10	VSS
B12	VTT06	M27	ADDR[13]	AC11	RCK3AP
B13	P06_TCN	M28	ADDR[14]	AC12	RCK3BP
B14	VDDX	M29	ADDR[15]	AC13	NO BALL
B15	P06_TBN	M30	ADDR[16]	AC14	NO BALL
B16	VTT06	M31	ADDR[17]	AC15	NO BALL
B17	P06_TAN	N1	P18_TAP	AC16	NO BALL
B18	VSS	N2	P18_TAN	AC17	NO BALL
B19	P04_TDN	N3	VSS	AC18	NO BALL



**Table 189. Package Ball Assignment in Numerical Order (Continued)**

B20	VTT04	N4	P18_RAP	AC19	NO BALL
B21	P04_TCN	N5	P18_RAN	AC20	RCK1BP
B22	VDDX	N6	VDDX	AC21	RCK1AP
B23	P04_TBN	N7	VDDX	AC22	VSS
B24	VTT04	N8	NO BALL	AC23	NC
B25	P04_TAN	N9	NO BALL	AC24	FH_PLL_CLKOUT
B26	VSS	N10	VDD	AC25	TRST_N
B27	VSS	N11	VDD	AC26	DIODE_OUT
B28	VTT02	N12	VDD	AC27	DTACK_INV
B29	VDDX	N13	VDD	AC28	NC
B30	VTT02	N14	VDD	AC29	NC
B31	VSS	N15	VDD	AC30	NC
C1	VSS	N16	VDD	AC31	NC
C2	VDDA	N17	VDD	AD1	VSS
C3	VSS	N18	VDD	AD2	VTT19
C4	VDDX	N19	VDD	AD3	VDDX
C5	VDDX	N20	VDD	AD4	VTT15
C6	VDDA	N21	VDD	AD5	VSS
C7	VDDX	N22	VDD	AD6	RREF11
C8	VDDX	N23	NO BALL	AD7	P11_TAP
C9	VSS	N24	NO BALL	AD8	RREF09
C10	VSS	N25	AUTOBOOT	AD9	P09_TAP
C11	VSS	N26	ADDR[18]	AD10	VSS
C12	VDDX	N27	ADDR[19]	AD11	RCK3AN
C13	VDDX	N28	ADDR[20]	AD12	RCK3BN
C14	VDDA	N29	ADDR[21]	AD13	NO BALL
C15	VDDX	N30	ADDR[22]	AD14	NO BALL
C16	VDDX	N31	ADDR[23]	AD15	NO BALL
C17	VSS	P1	VSS	AD16	NO BALL
C18	VSS	P2	VDDX	AD17	NO BALL
C19	VSS	P3	VDDA	AD18	NO BALL
C20	VDDX	P4	VDDX	AD19	NO BALL
C21	VDDX	P5	VSS	AD20	RCK1BN
C22	VDDA	P6	RREF20	AD21	RCK1AN
C23	VDDX	P7	RREF16	AD22	VSS
C24	VDDX	P8	NO BALL	AD23	NC
C25	VSS	P9	NO BALL	AD24	FH_PLL_REFCLK
C26	VSS	P10	VSS	AD25	TMS
C27	P02_RCN	P11	VSS	AD26	VSS
C28	P02_RCP	P12	VSS	AD27	VSS
C29	VDDX	P13	VSS	AD28	VSS
C30	P02_TCN	P14	VSS	AD29	VSS



Table 189. Package Ball Assignment in Numerical Order (Continued)

C31	P02_TCP	P15	VSS	AD30	VSS
D1	P14_RAP	P16	VSS	AD31	VSS
D2	RREF14	P17	VSS	AE1	P19_TAP
D3	P08_RDP	P18	VSS	AE2	P19_TAN
D4	VTT08	P19	VSS	AE3	VSS
D5	P08_RCP	P20	VSS	AE4	P19_RAP
D6	RREF08	P21	VSS	AE5	P19_RAN
D7	P08_RBP	P22	VSS	AE6	VTT11
D8	VTT08	P23	NO BALL	AE7	P11_TAN
D9	P08_RAP	P24	NO BALL	AE8	VTT09
D10	VSS	P25	RXRDY	AE9	P09_TAN
D11	P06_RDP	P26	TXRDY_N	AE10	VSS
D12	VTT06	P27	RXEOT	AE11	VSS
D13	P06_RCP	P28	IGN_PAR	AE12	VSS
D14	RREF06	P29	CS_N	AE13	VSS
D15	P06_RBP	P30	AS_N	AE14	VSS
D16	VTT06	P31	INTR_N	AE15	VDDX
D17	P06_RAP	R1	P24_TAP	AE16	VDDX
D18	VSS	R2	P24_TAN	AE17	VDDX
D19	P04_RDP	R3	VSS	AE18	VSS
D20	VTT04	R4	P24_RAP	AE19	VSS
D21	P04_RCP	R5	P24_RAN	AE20	VSS
D22	RREF04	R6	RREF22	AE21	VSS
D23	P04_RBP	R7	RREF18	AE22	VSS
D24	VTT04	R8	NO BALL	AE23	NC
D25	P04_RAP	R9	NO BALL	AE24	NC
D26	VSS	R10	VSS	AE25	TDO
D27	VSS	R11	VSS	AE26	VSS
D28	RREF02	R12	VSS	AE27	P01_RDN
D29	VDDA	R13	VDD	AE28	P01_RDP
D30	VDDX	R14	VDD	AE29	VSS
D31	VSS	R15	VSS	AE30	P01_TDN
E1	P14_RAN	R16	VSS	AE31	P01_TDP
E2	VTT14	R17	VSS	AF1	VSS
E3	P08_RDN	R18	VDD	AF2	VDDX
E4	VSS	R19	VDD	AF3	VDDA
E5	P08_RCN	R20	VSS	AF4	VDDX
E6	VSS	R21	VDD33	AF5	VSS
E7	P08_RBN	R22	VDD33	AF6	VDDX
E8	VSS	R23	NO BALL	AF7	VDDX
E9	P08_RAN	R24	NO BALL	AF8	VDDX
E10	VSS	R25	VSS	AF9	VDDX



**Table 189. Package Ball Assignment in Numerical Order (Continued)**

E11	P06_RDN	R26	VSS	AF10	VSS
E12	VSS	R27	NC	AF11	VSS
E13	P06_RCN	R28	RW_N	AF12	VSS
E14	VSS	R29	CLK_CPU	AF13	VSS
E15	P06_RBN	R30	VDD33	AF14	VSS
E16	VSS	R31	VDD33	AF15	VSS
E17	P06_RAN	T1	VSS	AF16	VSS
E18	VSS	T2	VTT23	AF17	VSS
E19	P04_RDN	T3	VDDX	AF18	VSS
E20	VSS	T4	VTT24	AF19	VSS
E21	P04_RCN	T5	VSS	AF20	VSS
E22	VSS	T6	RREF24	AF21	VSS
E23	P04_RBN	T7	RREF23	AF22	VSS
E24	VSS	T8	NO BALL	AF23	VSS
E25	P04_RAN	T9	NO BALL	AF24	VSS
E26	VSS	T10	VDD	AF25	VSS
E27	P02_RBN	T11	VDD	AF26	VSS
E28	P02_RBP	T12	VDD	AF27	VSS
E29	VDDX	T13	VDD	AF28	VTT01
E30	P02_TBN	T14	VDD	AF29	VDDX
E31	P02_TBP	T15	VSS	AF30	VTT01
F1	VSS	T16	VSS	AF31	VSS
F2	VDDX	T17	VSS	AG1	P13_RAN
F3	VDDA	T18	VDD	AG2	VTT13
F4	VDDX	T19	VDD	AG3	P07_RAN
F5	VSS	T20	VDD	AG4	VSS
F6	VDDX	T21	VDD33	AG5	P07_RBN
F7	VDDX	T22	VDD33	AG6	VSS
F8	VDDX	T23	NO BALL	AG7	P07_RCN
F9	VDDX	T24	NO BALL	AG8	VSS
F10	VSS	T25	VSS	AG9	P07_RDN
F11	VSS	T26	CPU_RESET_N	AG10	VSS
F12	VSS	T27	NC	AG11	P05_RAN
F13	VSS	T28	PAR[0]	AG12	VSS
F14	VSS	T29	PAR[1]	AG13	P05_RBN
F15	VSS	T30	VDD33	AG14	VSS
F16	VSS	T31	VDD33	AG15	P05_RCN
F17	VSS	U1	P23_TAP	AG16	VSS
F18	VSS	U2	P23_TAN	AG17	P05_RDN
F19	VSS	U3	VSS	AG18	VSS
F20	VSS	U4	P23_RAP	AG19	P03_RAN
F21	VSS	U5	P23_RAN	AG20	VSS





Table 189. Package Ball Assignment in Numerical Order (Continued)

F22	VSS	U6	RREF17	AG21	P03_RBN
F23	VSS	U7	RREF21	AG22	VSS
F24	VSS	U8	NO BALL	AG23	P03_RCN
F25	VSS	U9	NO BALL	AG24	VSS
F26	VSS	U10	VSS	AG25	P03_RDN
F27	VSS	U11	VSS	AG26	VSS
F28	VTT02	U12	VSS	AG27	P01_RCN
F29	VDDX	U13	VDD	AG28	P01_RCP
F30	VTT02	U14	VDD	AG29	VDDX
F31	VSS	U15	VSS	AG30	P01_TCN
G1	P20_TAP	U16	VSS	AG31	P01_TCP
G2	P20_TAN	U17	VSS	AH1	P13_RAP
G3	VSS	U18	VDD	AH2	RREF13
G4	P20_RAP	U19	VDD	AH3	P07_RAP
G5	P20_RAN	U20	VSS	AH4	VTT07
G6	VTT12	U21	VDD33	AH5	P07_RBP
G7	P12_TAP	U22	VDD33	AH6	RREF07
G8	VTT10	U23	NO BALL	AH7	P07_RCP
G9	P10_TAP	U24	NO BALL	AH8	VTT07
G10	VSS	U25	VSS	AH9	P07_RDP
G11	VSS	U26	VSS	AH10	VSS
G12	VSS	U27	NC	AH11	P05_RAP
G13	VSS	U28	PAR[2]	AH12	VTT05
G14	VSS	U29	PAR[3]	AH13	P05_RBP
G15	VDDX	U30	VDD33	AH14	RREF05
G16	VDDX	U31	VDD33	AH15	P05_RCP
G17	VDDX	V1	VSS	AH16	VTT05
G18	VSS	V2	VDDX	AH17	P05_RDP
G19	VSS	V3	VDDA	AH18	VSS
G20	VSS	V4	VDDX	AH19	P03_RAP
G21	VSS	V5	VSS	AH20	VTT03
G22	VSS	V6	RREF15	AH21	P03_RBP
G23	CONT_EN	V7	RREF19	AH22	RREF03
G24	LEDCLK	V8	NO BALL	AH23	P03_RCP
G25	NC	V9	NO BALL	AH24	VTT03
G26	VSS	V10	VSS	AH25	P03_RDP
G27	P02_RAN	V11	VSS	AH26	VSS
G28	P02_RAP	V12	VSS	AH27	VSS
G29	VSS	V13	VSS	AH28	RREF01
G30	P02_TAN	V14	VSS	AH29	VDDA
G31	P02_TAP	V15	VSS	AH30	VDDX
H1	VSS	V16	VSS	AH31	VSS



**Table 189. Package Ball Assignment in Numerical Order (Continued)**

H2	VTT16	V17	VSS	AJ1	VSS
H3	VDDX	V18	VSS	AJ2	VDDA
H4	VTT20	V19	VSS	AJ3	VSS
H5	VSS	V20	VSS	AJ4	VDDX
H6	RREF12	V21	VSS	AJ5	VDDX
H7	P12_TAN	V22	VSS	AJ6	VDDA
H8	RREF10	V23	NO BALL	AJ7	VDDX
H9	P10_TAN	V24	NO BALL	AJ8	VDDX
H10	VSS	V25	DATA[1]	AJ9	VSS
H11	RCK4AP	V26	DATA[2]	AJ10	VSS
H12	RCK4BP	V27	DATA[3]	AJ11	VSS
H13	NO BALL	V28	DATA[4]	AJ12	VDDX
H14	NO BALL	V29	DATA[5]	AJ13	VDDX
H15	NO BALL	V30	DATA[6]	AJ14	VDDA
H16	NO BALL	V31	DATA[0]	AJ15	VDDX
H17	NO BALL	W1	P17_TAP	AJ16	VDDX
H18	NO BALL	W2	P17_TAN	AJ17	VSS
H19	NO BALL	W3	VSS	AJ18	VSS
H20	RCK2BP	W4	P17_RAP	AJ19	VSS
H21	RCK2AP	W5	P17_RAN	AJ20	VDDX
H22	VSS	W6	VDDX	AJ21	VDDX
H23	CONT_OUT	W7	VDDX	AJ22	VDDA
H24	LED_DATA0	W8	NO BALL	AJ23	VDDX
H25	NC	W9	NO BALL	AJ24	VDDX
H26	VSS	W10	VDD	AJ25	VSS
H27	VSS	W11	VDD	AJ26	VSS
H28	VSS	W12	VDD	AJ27	P01_RBN
H29	VSS	W13	VDD	AJ28	P01_RBP
H30	VSS	W14	VDD	AJ29	VDDX
H31	VSS	W15	VDD	AJ30	P01_TBN
J1	P16_TAP	W16	VDD	AJ31	P01_TBP
J2	P16_TAN	W17	VDD	AK1	P13_TAN
J3	VSS	W18	VDD	AK2	VDDX
J4	P16_RAP	W19	VDD	AK3	P07_TAN
J5	P16_RAN	W20	VDD	AK4	VTT07
J6	VDDX	W21	VDD	AK5	P07_TBN
J7	VSS	W22	VDD	AK6	VDDX
J8	VDDA	W23	NO BALL	AK7	P07_TCN
J9	VSS	W24	NO BALL	AK8	VTT07
J10	VSS	W25	DATA[7]	AK9	P07_TDN
J11	RCK4AN	W26	DATA[8]	AK10	VSS
J12	RCK4BN	W27	DATA[9]	AK11	P05_TAN



Table 189. Package Ball Assignment in Numerical Order (Continued)

J13	NO BALL	W28	DATA[10]	AK12	VTT05
J14	NO BALL	W29	DATA[11]	AK13	P05_TBN
J15	NO BALL	W30	DATA[12]	AK14	VDDX
J16	NO BALL	W31	DATA[13]	AK15	P05_TCN
J17	NO BALL	Y1	VSS	AK16	VTT05
J18	NO BALL	Y2	VTT21	AK17	P05_TDN
J19	NO BALL	Y3	VDDX	AK18	VSS
J20	RCK2BN	Y4	VTT17	AK19	P03_TAN
J21	RCK2AN	Y5	VSS	AK20	VTT03
J22	VSS	Y6	VDDX	AK21	P03_TBN
J23	EEPROM_EN	Y7	VDDX	AK22	VDDX
J24	LED_DATA1	Y8	NO BALL	AK23	P03_TCN
J25	DTACK_N	Y9	NO BALL	AK24	VTT03
J26	NC	Y10	VDD	AK25	P03_TDN
J27	CHIP_RESET_N	Y11	VDD	AK26	VSS
J28	NC	Y12	VDD	AK27	VSS
J29	NC	Y13	VDD	AK28	VTT01
J30	SPI_CS_N	Y14	VDD	AK29	VDDX
J31	SPI_SI	Y15	VDD	AK30	VTT01
K1	VSS	Y16	VDD	AK31	VSS
K2	VDDX	Y17	VDD	AL1	P13_TAP
K3	VDDA	Y18	VDD	AL2	VSS
K4	VDDX	Y19	VDD	AL3	P07_TAP
K5	VSS	Y20	VDD	AL4	VSS
K6	VSS	Y21	VDD	AL5	P07_TBP
K7	P12_RAP	Y22	VDD	AL6	VSS
K8	VDDX	Y23	NO BALL	AL7	P07_TCP
K9	P10_RAP	Y24	NO BALL	AL8	VSS
K10	VSS	Y25	DATA[14]	AL9	P07_TDP
K11	VSS	Y26	DATA[15]	AL10	VSS
K12	VSS	Y27	DATA[16]	AL11	P05_TAP
K13	VSS	Y28	DATA[17]	AL12	VSS
K14	VSS	Y29	DATA[18]	AL13	P05_TBP
K15	VDD	Y30	DATA[19]	AL14	VSS
K16	VDD	Y31	DATA[20]	AL15	P05_TCP
K17	VDD	AA1	P21_TAP	AL16	VSS
K18	VSS	AA2	P21_TAN	AL17	P05_TDP
K19	VSS	AA3	VSS	AL18	VSS
K20	VSS	AA4	P21_RAP	AL19	P03_TAP
K21	VSS	AA5	P21_RAN	AL20	VSS
K22	VSS	AA6	VSS	AL21	P03_TBP
K23	LED_EN	AA7	P11_RAP	AL22	VSS



**Table 189. Package Ball Assignment in Numerical Order (Continued)**

K24	LED_DATA2	AA8	VSS	AL23	P03_TCP
K25	ADDR[3]	AA9	P09_RAP	AL24	VSS
K26	NC	AA10	VSS	AL25	P03_TDP
K27	NC	AA11	VSS	AL26	VSS
K28	NC	AA12	VSS	AL27	P01_RAN
K29	ADDR[2]	AA13	VSS	AL28	P01_RAP
K30	SPI_SO	AA14	VSS	AL29	VSS
K31	SPI_SCK	AA15	VDD	AL30	P01_TAN
L1	P22_TAP	AA16	VDD	AL31	P01_TAP
L2	P22_TAN	AA17	VDD		
L3	VSS	AA18	VSS		
L4	P22_RAP	AA19	VSS		
L5	P22_RAN	AA20	VSS		
L6	VSS	AA21	VSS		
L7	P12_RAN	AA22	VSS		
L8	VSS	AA23	VSS		
L9	P10_RAN	AA24	VDDA33		
L10	VSS	AA25	TDI		
L11	VSS	AA26	DATA[21]		
L12	VSS	AA27	DATA[22]		
L13	VSS	AA28	DATA[23]		
L14	VSS	AA29	DATA[24]		
L15	VDD	AA30	DATA[25]		

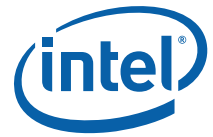

## 6.5 Package Dimensions

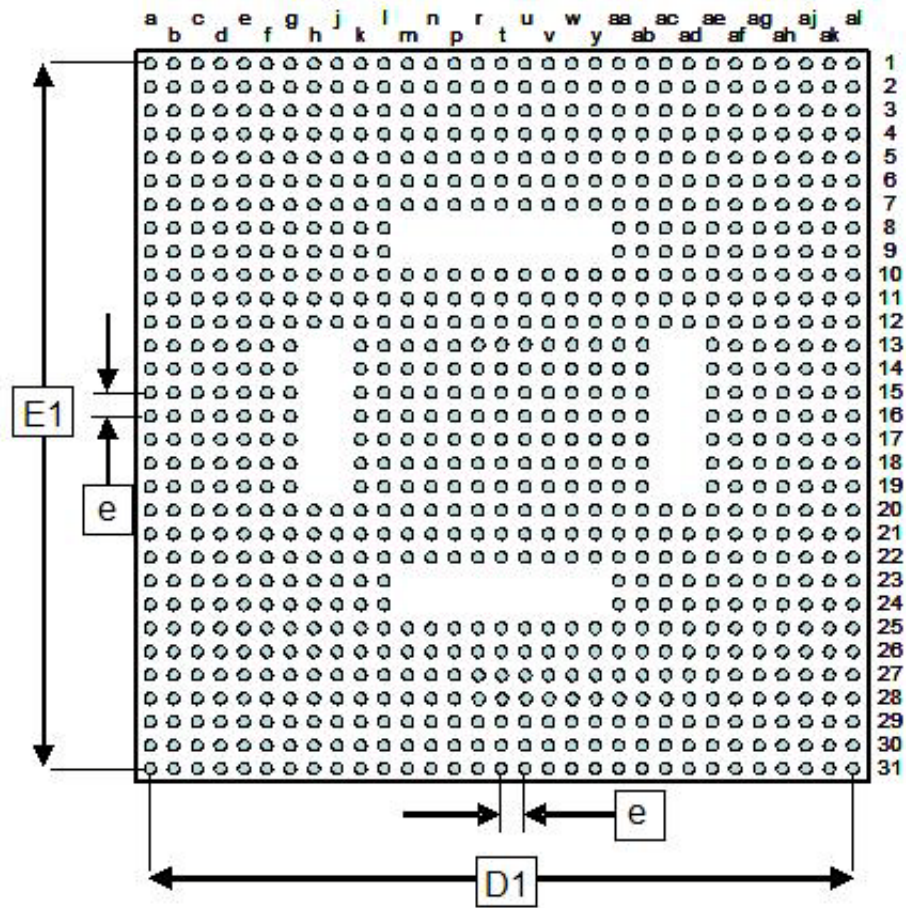

Figure 25. FM2112 Package Bottom View

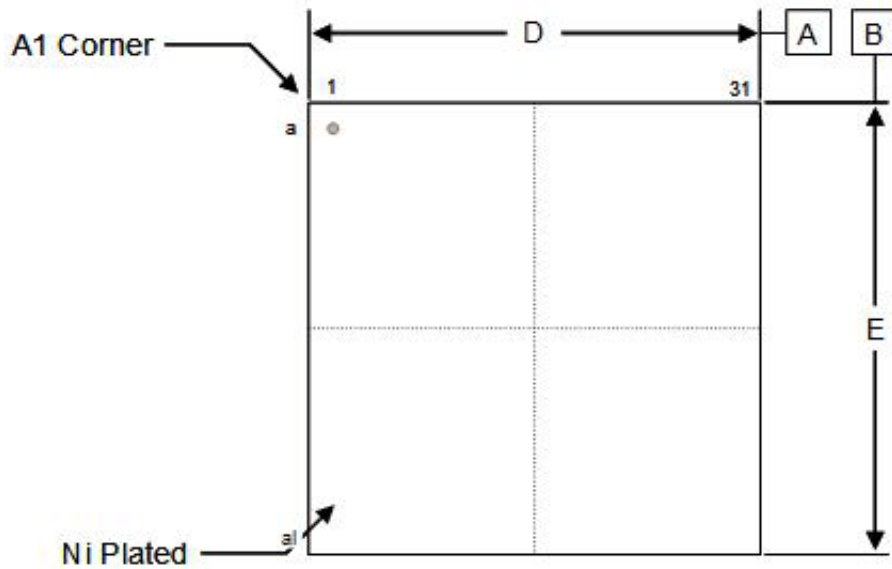

Figure 26. M2112 Package Top View (relative to the bottom view, the package has been flipped holding the a1-a131 diagonal constant)

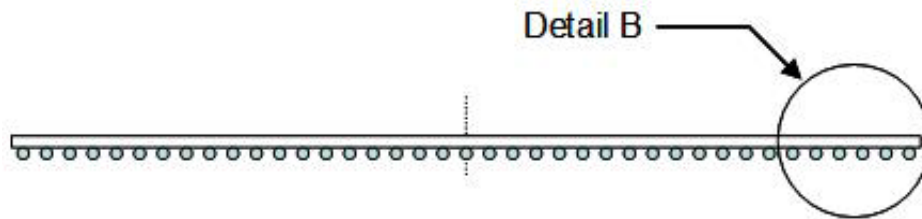

Figure 27. FM2112 Package Side View

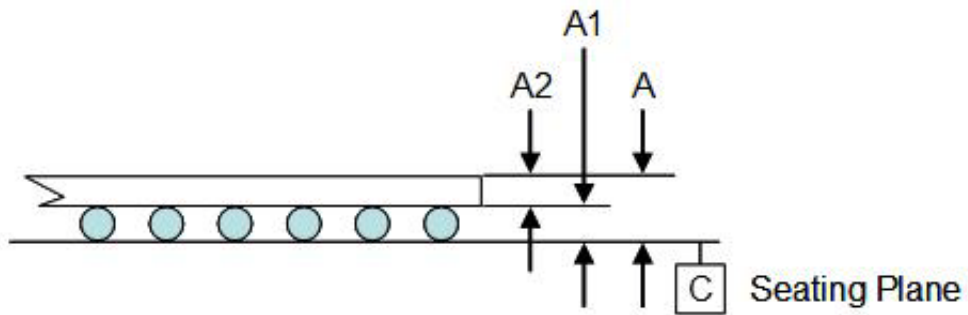

Figure 28. Expanded Detail B of Side View

**Table 190. Dimensions Used in Figures**

Dimensional References			
Reference	Min	Nom	Max
A	2.67	3.07	3.47
A1	0.39	0.49	0.59
A2	2.18	2.58	2.98
D	31.80	32.00	32.20
D1	30.0 BSC		
E	31.80	32.00	32.20
E1	30.0 BSC		
e	1.00 BSC		
M	31		
N	897		
Ref.: JEDEC MS-034 B			

**Notes:**

- All dimensions are in millimeters.
- "e" represents the basic solder ball grid pitch.
- "M" represents the basic solder ball matrix size, and symbol "N" is the maximum allowable number of balls after depopulating.
- Primary datum C and Seating Plane are defined by the spherical crowns of the solder balls.
- Package surface is Ni plated.
- Black spot (or circular etch) for pin 1 identification.
- Dimensioning and tolerancing per ASME Y14.5M 1994

## 6.6 Power Dissipation and Heat Sinking

### 6.6.1 Power Dissipation

The power dissipation of the FM2112 is dependent on a number of different operational factors including:

- The number of ports in operation
- The operating rate of each port (10 Gbps, 2.5 Gbps, 1.0 Gbps, etc)
- The utilization factor of each port (the percentage of the bit stream that is actual data, vs. 8B/10B idle characters)
- The distribution of frame sizes
- SerDes drive strengths
- Use of the CPU interface
- Supply voltages
- Temperature



Though the dependencies above have a considerable effect on supply current draws and overall power dissipation, useful guidelines can be provided through measured data under two operating conditions. One condition consists of the most aggressive possible values for the parameters that have the most impact, namely utilization percentage and frame size. Other parameters such as SerDes drive strength, supply voltages and case temperatures are kept at nominal values. Values under a second, more typical use model assume more moderate values for frame sizes and utilization percentages, while keeping the other parameters at their nominal values. The test conditions and resulting current draws and overall power dissipation values are shown in Table 191 and Table 192.

**Table 191. Conditions for Power Measurements**

Parameter	Aggressive Case	Typical
Operating ports	24	24
Operating rate of ports	8x10G, 16x1G	8x10G, 16x1G
Utilization factor	100%	50%
Frame size	64B	256B
SerDes drive parameters	Nominal	Nominal
CPU utilization	Not in use	Not in use
Supply voltages	Nominal	Nominal
Temperature, case	~60°C	~60°C
Frame handler clock	200 MHz	200 MHz

**Table 192. FM2112 Currents and Power**

	Power Supply Currents (A)			Total Power (W)
	I <sub>DD</sub>	I <sub>DDX</sub>	I <sub>TT</sub>	
	(V <sub>DD</sub> =1.2V)	(V <sub>DDX</sub> =1.0V)	(V <sub>TT</sub> =1.5V)	
Typical Use	7.8	3.0	1.3	14.3
Most Aggressive	11.3	3.0	1.3	18.5

Notes:

- (1) I<sub>DDA</sub> is approximately 10 mA per port and is measured as a part of I<sub>DDX</sub>.
- (2) V<sub>DDA33</sub> is approximately 4 mA
- (3) V<sub>DD33</sub> is used for the CPU interface and no current is drawn when not in use.
- (4) Using V<sub>DDX</sub> = 1.2V will raise power dissipations by up to 2W, depending on use parameters.

### 6.6.2 Heat Sinking

It is anticipated that a heat sink will be required for most FM2112 applications. The goal of heat sink design is to keep the operating case temperature of the device below its maximum allowed value. This will also ensure that the junction stays below its maximum allowable





temperature of 125 °C. With a junction-to-case thermal resistance ( $\theta_{JC}$ ) of only 0.15 °C/W, even the highest allowed value of case temperature, 115°C, will keep the junction temperature below 125°C. This is true even assuming a worst case power dissipation approaching 20W, which results in a 3°C rise in junction temperature over case temperature ( $20W \times 0.15^{\circ}C/W = 3^{\circ}C$ ).

The relevant thermal parameters for choosing or designing a heat sink are listed in [Table 193](#). A heat sink is chosen based on the value of CA it gives in the presence of the anticipated airflow. The resulting case temperature is calculated using the parallel combination of  $\theta_{CA}$  and  $\Psi_{JB}$  multiplied by the expected power dissipation.

**Table 193. FM2112 Thermal Parameters**

Parameter	Description	Value	
$\theta_{JC}$	Thermal resistance, junction to case	0.15 °C/Watt	
$\Psi_{JB}^{1,2}$	Thermal resistance, junction to board	4.5 °C/Watt	
$P_{diss(max)}$	Maximum power dissipation. 8 ports operating in 10G mode and 16 ports operating in 1G mode. Min frame size (64B) and min IFG (12B) on all ports.	19 Watts	
$T_{CASE(max)}$	Maximum case temperature	Commercial, -C	85 °C
		Extended, -E	105 °C
		Industrial, -I	115 °C

*Notes:*

(1) This parameter is similar to JB as defined by JEDEC, except that the presence of an isothermal cold ring is not assumed. The value of JB is more relevant to real world use scenarios.

(2) The PC board is assumed to be at ambient temperature.

### 6.6.3 Temperature Sensor Operation

The FM2112 has an integrated temperature sensing diode on board with LVTTTL outputs DIODE\_IN and DIODE\_OUT. Die temperature is read using these outputs through a temperature sensor IC such as the National LM95231. The temperature as reported by this IC has been checked in temperature controlled conditions across a range of temperatures. It was found that the LM95231 measured temperature was higher than the controlled case temperature by approximately 11 to 13 °C. [Table 194](#) shows the corrections that must be applied to the LM95231 temperature to arrive at the correct case temperature. Temperature readings with this IC are not expected to be degree-accurate, but approximately +/- 5°C. Temperature accuracy with other IC's is unspecified and may vary significantly from the table below, especially for those IC's where series resistance nulling is used.



**Table 194. LM95231 Temperature Offsets**

Tcase	Tmeas (LM95231)	Tmeas - Tcase
-44.6	-33.0	11.6
-27.4	-15.0	12.4
-10.0	2.5	12.5
7.6	20.0	12.4
31.4	44	12.6
35.8	48.5	12.7
50.0	62.5	12.5
70.0	82.5	12.5
92.4	105.0	12.6
110.8	123.5	12.7
119.4	132.5	13.1
120.5	133.5	13.0



## 7.0 Document Revision Information

The following tables list the changes made to the FM2112 Datasheet resulting in the publication of a new revision.

### 7.1 Nomenclature

Document revisions are placed in either of two categories to allow the user to quickly focus on changes of a substantive nature (Category 1), that is, changes that may have an impact on system or board level design.

Category 1 changes describe documentation revisions that reflect substantial changes in the way the form, fit or function of the device is described. These changes may affect the design of a product using the device. An example might be the correction of a wrong pin number assignment because that would affect the trace routing on a board.

Category 2 changes are documentation changes consisting of clarifications or corrections, primarily to descriptive or graphical sections, and do not represent substantial changes in the descriptions of form, fit or function. Typo's and grammatical error corrections are not recorded in the table below.

### 7.2 Rev 1.0 to 1.1 Changes

	Page	Category		Description
		1	2	
1	46		X	Removed references to a switch priority protected from the PWD mechanism. Also noted in QUEUE_CFG_1 register.
2	113		X	Added note of clarification to <a href="#">Table 108</a> .
3	74		X	<a href="#">Figure 22</a> : Removed reference to DS_N pin, which does not exist.
4	85		X	<a href="#">Table 41</a> : Added version number for A5 silicon.
5	23	X		<a href="#">Table 1</a> : Corrected RCK to port assignments for the 4 port groups
6	144	X		<a href="#">Table 179</a> . Corrected RCK to port assignments for the 4 port groups.
7	129		X	<a href="#">Table 144</a> : Recommend setting "Ignore IFG errors" and "Ignore preamble" errors bits.
8	129		X	<a href="#">Table 144</a> : Change bits 3:0 from reserved to LF, controlling the /K/A/R randomization.
9	151		X	Added note on power supply sequencing
10	149	X		<a href="#">Table 185</a> : Changed TESTMODE pin from "leave unconnected" to "pull down".
11	72		X	<a href="#">Table 23</a> : Add note on overshoot for $V_{IH}$ on LVTTTL inputs.
12	111		X	<a href="#">Table 100</a> : QUEUE_CFG_1, TX shared watermark. Remove text to the effect that switch priority 15 is exempt from PWD dropping
17	106		X	<a href="#">Table 90</a> : Include new definitions of 3 bits in TRUNK_HASH_MASK table.
18	113		X	<a href="#">Table 104</a> : Documented QUEUE_CFG_5 register, which had been missing.



19	126		X	Table 136: BIST mode 0x2 corrected to D21.5 pattern.
20	-		X	Removed references to FUSEBOX and SHADOW FUSEBOX register operations in several locations. Fusebox processing is not customer configurable.
21	79		X	Added Table 32: Statistics and Counter Registers table to register map.
22	59		X	Added serdes power-up procedure to Step 4 of Bring-up without EEPROM procedure.

### 7.3 Rev 2.0 to 2.1 Changes

	Page	Category		Description
		1	2	
1	162		X	Made several additions/corrections to the page numbers and Table numbers in Rev 1.0 to 2.0 change table.
2	150		X	Table 186: Removed N26, N27, N28 from table of "No Connects" these are actually ADDR pins.
3	59		X	Step 4 Enabling Ports: Clarified serdes bring-up procedure.
4	162		X	Added thermal parameter information.
5	152		X	Clarified power sequencing at boot-up.
6	122		X	Table 121, VLANegressBVDrops: removed the word "unicast" as this applies to multicast also
7	86		X	Table 42, Bypass bit: Replace CPU_CLK with FH_PLL_REFCLK, as this is the actual PLL reference clock.
8	65		X	Added section 3.5.5.1, clarifying the LED clock divider scheme
9	85		X	Table 39: clarified LEDfreq description.
10	68		X	Table 17: Update silicon version bit description.
11	122		X	Table 122: changed offset for TXMulticast register to 0x70024+0x200*I, and removed +0x26 and +0x27 from offsets for TxPause and TxFCSErrors, respectively.

### 7.4 Rev 2.1 to 2.2 Changes

	Page	Category		Description
		1	2	
1	163		X	Added section 6.6.3 on Temperature Sensor Operation
3	34		X	Improve description of Discard Egress Boundary Violation
4	98		X	Clarify behavior of PORT_CFG_1:VLAN ingress port precedence
5	164		X	Change Vddx = 1.2V penalty (vs 1.0V) from 4W to 2W.
6	71		X	Recommended Operating Conditions, Note 4: added note of caution if using Vddx = 1.2V.
7	108		X	Table 91 TRUNK_HASH_MASK: Modify VLAN-PRI to note that the CFI bit is included.
8	36		X	Removed reference to support for IGMPv3 Snooping. Limitations on its use render it not practical to use.
9	119		X	Table 101: Bit names changed to Tx and Rx Hog watermarks. They are not associated with PWD.

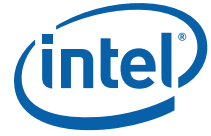

10	63		X	Section 3.5.4: Change Wait command description to express wait cycles in terms of SPI clock, not CPU clock.
11	79		X	<a href="#">Table 29</a> : Corrected register addresses for PORT_VLAN_IP1/2 and PORT_VLAN_IM1/2.
12	86		X	<a href="#">Table 41</a> : Frame Timer default changed to 0x0
13	136		X	<a href="#">Table 158</a> : Included recommendations for setting value of PAUSE resend interval
14	123		X	Group 7 Counters: Modify Unicast, Multicast and Broadcast to include possible bad FCS frames.

§ §







**NOTE:**      *This page intentionally left blank.*



## Данный компонент на территории Российской Федерации

### Вы можете приобрести в компании MosChip.

Для оперативного оформления запроса Вам необходимо перейти по данной ссылке:

<http://moschip.ru/get-element>

Вы можете разместить у нас заказ для любого Вашего проекта, будь то серийное производство или разработка единичного прибора.

В нашем ассортименте представлены ведущие мировые производители активных и пассивных электронных компонентов.

Нашей специализацией является поставка электронной компонентной базы двойного назначения, продукции таких производителей как XILINX, Intel (ex.ALTERA), Vicor, Microchip, Texas Instruments, Analog Devices, Mini-Circuits, Amphenol, Glenair.

Сотрудничество с глобальными дистрибьюторами электронных компонентов, предоставляет возможность заказывать и получать с международных складов практически любой перечень компонентов в оптимальные для Вас сроки.

На всех этапах разработки и производства наши партнеры могут получить квалифицированную поддержку опытных инженеров.

Система менеджмента качества компании отвечает требованиям в соответствии с ГОСТ Р ИСО 9001, ГОСТ РВ 0015-002 и ЭС РД 009

### Офис по работе с юридическими лицами:

105318, г.Москва, ул.Щербаковская д.3, офис 1107, 1118, ДЦ «Щербаковский»

Телефон: +7 495 668-12-70 (многоканальный)

Факс: +7 495 668-12-70 (доб.304)

E-mail: [info@moschip.ru](mailto:info@moschip.ru)

Skype отдела продаж:

moschip.ru

moschip.ru\_4

moschip.ru\_6

moschip.ru\_9