

## Dome Lens SMD LED



VLD.1535R...



VLD.1535G...

### DESCRIPTION

The dome lens SMD LED series has been designed in a small untinted and clear molded package with lens for surface mounting as gullwing or reverse gullwing version. The VLD.1535... series is using recent ultrabright AllnGaP / Si chip technology with high luminous flux and large chip size allowing a high DC forward current up to 70 mA.

### PRODUCT GROUP AND PACKAGE DATA

- Product group: LED
- Product series: power
- Package: SMD dome lens
- Angle of half intensity:  $\pm 22^\circ$

### FEATURES

- Utilizing latest advanced AllnGaP technology
- Package type: surface-mount
- Package form: gullwing, reverse gullwing
- Dimensions (L x W x H in mm): 2.3 x 2.3 x 2.6
- High luminous flux and luminous intensity
- Luminous intensity and color categorized per packing unit
- Luminous intensity ratio per packing unit  $I_{Vmax}/I_{Vmin} \leq 1.6$
- ESD-withstand voltage: up to 2 kV according to JESD22-A114-B
- Preconditioning according to JEDEC® level 2a
- Suitable for reflow soldering according to J-STD-020
- Material categorization: for definitions of compliance please see [www.vishay.com/doc?99912](http://www.vishay.com/doc?99912)



### APPLICATIONS

- Traffic signals and signs
- Interior and exterior lighting
- Indicator and backlighting purposes for audio, video, LCDs switches, symbols, illuminated advertising etc.

PARTS TABLE														
PART	COLOR	LUMINOUS INTENSITY (mcd)			at $I_F$ (mA)	WAVELENGTH (nm)			at $I_F$ (mA)	FORWARD VOLTAGE (V)			at $I_F$ (mA)	TECHNOLOGY
		MIN.	TYP.	MAX.		MIN.	TYP.	MAX.		MIN.	TYP.	MAX.		
VLDS1535G-08	Super red	2800	5000	9000	50	626	630	637	50	1.9	2.2	2.7	50	AllnGaP on Si
VLDS1535R-08	Super red	2800	5000	9000	50	626	630	637	50	1.9	2.2	2.7	50	AllnGaP on Si
VLDR1535G-08	Red	3550	6500	11 200	50	619	624	631	50	1.9	2.2	2.7	50	AllnGaP on Si
VLDR1535R-08	Red	3550	6500	11 200	50	619	624	631	50	1.9	2.2	2.7	50	AllnGaP on Si
VLDK1535G-08	Amber	4500	8000	14 000	50	611	616	621	50	1.9	2.25	2.7	50	AllnGaP on Si
VLDK1535R-08	Amber	4500	8000	14 000	50	611	616	621	50	1.9	2.25	2.7	50	AllnGaP on Si
VLDY1535G-08	Yellow	4500	8000	14 000	50	583	589	595	50	1.9	2.3	2.7	50	AllnGaP on Si
VLDY1535R-08	Yellow	4500	8000	14 000	50	583	589	595	50	1.9	2.3	2.7	50	AllnGaP on Si

ABSOLUTE MAXIMUM RATINGS ( $T_{amb} = 25^\circ\text{C}$ , unless otherwise specified)				
VLDS1535..., VLDR1535..., VLDK1535..., VLDY1535...				
PARAMETER	TEST CONDITION	SYMBOL	VALUE	UNIT
Reverse voltage <sup>(1)</sup>	Short term application only	$V_R$	5	V
DC Forward current	$T_{amb} \leq 60^\circ\text{C}$	$I_F$	70	mA
Power dissipation		$P_V$	200	mW
Junction temperature		$T_j$	125	$^\circ\text{C}$
Operating temperature range		$T_{amb}$	-40 to +100	$^\circ\text{C}$
Storage temperature range		$T_{stg}$	-40 to +100	$^\circ\text{C}$
Thermal resistance junction-to-ambient	Mounted on PC board (pad size > 16 mm <sup>2</sup> )	$R_{thJA}$	325	K/W

#### Note

<sup>(1)</sup> Driving the LED in reverse direction is suitable for a short term application only



<b>OPTICAL AND ELECTRICAL CHARACTERISTICS</b> ( $T_{amb} = 25\text{ }^{\circ}\text{C}$ , unless otherwise specified) <b>VLDS1535G, VLDS1535R, SUPER RED</b>						
PARAMETER	TEST CONDITION	SYMBOL	MIN.	TYP.	MAX.	UNIT
Luminous intensity <sup>(1)</sup>	$I_F = 50\text{ mA}$	$I_V$	2800	5000	9000	mcd
Luminous flux/luminous intensity		$\phi_V/I_V$	-	1.2	-	mlm/mcd
Dominant wavelength <sup>(1)</sup>	$I_F = 50\text{ mA}$	$\lambda_d$	626	630	637	nm
Peak wavelength	$I_F = 50\text{ mA}$	$\lambda_p$	-	639	-	nm
Spectral bandwidth at 50 % $I_{rel\ max.}$	$I_F = 50\text{ mA}$	$\Delta\lambda$	-	18	-	nm
Angle of half intensity	$I_F = 50\text{ mA}$	$\phi$	-	$\pm 22$	-	deg
Forward voltage <sup>(1)</sup>	$I_F = 50\text{ mA}$	$V_F$	1.9	2.2	2.7	V
Reverse current	$V_R = 5\text{ V}$	$I_R$	-	0.01	10	$\mu\text{A}$

**Note**

<sup>(1)</sup> Tolerances:  $\pm 15\%$  for  $I_V$ ,  $\pm 0.1\text{ V}$  for  $V_F$ ,  $\pm 1\text{ nm}$  for  $\lambda_d$

<b>OPTICAL AND ELECTRICAL CHARACTERISTICS</b> ( $T_{amb} = 25\text{ }^{\circ}\text{C}$ , unless otherwise specified) <b>VLDR1535G, VLDR1535R, RED</b>						
PARAMETER	TEST CONDITION	SYMBOL	MIN.	TYP.	MAX.	UNIT
Luminous intensity <sup>(1)</sup>	$I_F = 50\text{ mA}$	$I_V$	3550	6500	11 200	mcd
Luminous flux/luminous intensity		$\phi_V/I_V$	-	1.2	-	mlm/mcd
Dominant wavelength <sup>(1)</sup>	$I_F = 50\text{ mA}$	$\lambda_d$	619	624	631	nm
Peak wavelength	$I_F = 50\text{ mA}$	$\lambda_p$	-	632	-	nm
Spectral bandwidth at 50 % $I_{rel\ max.}$	$I_F = 50\text{ mA}$	$\Delta\lambda$	-	18	-	nm
Angle of half intensity	$I_F = 50\text{ mA}$	$\phi$	-	$\pm 22$	-	deg
Forward voltage <sup>(1)</sup>	$I_F = 50\text{ mA}$	$V_F$	1.9	2.2	2.7	V
Reverse current	$V_R = 5\text{ V}$	$I_R$	-	0.01	10	$\mu\text{A}$

**Note**

<sup>(1)</sup> Tolerances:  $\pm 15\%$  for  $I_V$ ,  $\pm 0.1\text{ V}$  for  $V_F$ ,  $\pm 1\text{ nm}$  for  $\lambda_d$

<b>OPTICAL AND ELECTRICAL CHARACTERISTICS</b> ( $T_{amb} = 25\text{ }^{\circ}\text{C}$ , unless otherwise specified) <b>VLDK1535G, VLDK1535R, AMBER</b>						
PARAMETER	TEST CONDITION	SYMBOL	MIN.	TYP.	MAX.	UNIT
Luminous intensity <sup>(1)</sup>	$I_F = 50\text{ mA}$	$I_V$	4500	8000	14 000	mcd
Luminous flux/luminous intensity		$\phi_V/I_V$	-	1.2	-	mlm/mcd
Dominant wavelength <sup>(1)</sup>	$I_F = 50\text{ mA}$	$\lambda_d$	611	616	621	nm
Peak wavelength	$I_F = 50\text{ mA}$	$\lambda_p$	-	622	-	nm
Spectral bandwidth at 50 % $I_{rel\ max.}$	$I_F = 50\text{ mA}$	$\Delta\lambda$	-	18	-	nm
Angle of half intensity	$I_F = 50\text{ mA}$	$\phi$	-	$\pm 22$	-	deg
Forward voltage <sup>(1)</sup>	$I_F = 50\text{ mA}$	$V_F$	1.9	2.25	2.7	V
Reverse current	$V_R = 5\text{ V}$	$I_R$	-	0.01	10	$\mu\text{A}$

**Note**

<sup>(1)</sup> Tolerances:  $\pm 15\%$  for  $I_V$ ,  $\pm 0.1\text{ V}$  for  $V_F$ ,  $\pm 1\text{ nm}$  for  $\lambda_d$



<b>OPTICAL AND ELECTRICAL CHARACTERISTICS</b> ( $T_{amb} = 25\text{ }^{\circ}\text{C}$ , unless otherwise specified) <b>VLDY1535G, VLDY1535R, YELLOW</b>						
PARAMETER	TEST CONDITION	SYMBOL	MIN.	TYP.	MAX.	UNIT
Luminous intensity <sup>(1)</sup>	$I_F = 50\text{ mA}$	$I_V$	4500	8000	14 000	mcd
Luminous flux/luminous intensity		$\phi_V/I_V$	-	1.2	-	mlm/mcd
Dominant wavelength <sup>(1)</sup>	$I_F = 50\text{ mA}$	$\lambda_d$	583	589	595	nm
Peak wavelength	$I_F = 50\text{ mA}$	$\lambda_p$	-	591	-	nm
Spectral bandwidth at 50 % $I_{rel\ max.}$	$I_F = 50\text{ mA}$	$\Delta\lambda$		17		nm
Angle of half intensity	$I_F = 50\text{ mA}$	$\phi$		$\pm 22$		deg
Forward voltage <sup>(1)</sup>	$I_F = 50\text{ mA}$	$V_F$	1.9	2.3	2.7	V
Reverse current	$V_R = 5\text{ V}$	$I_R$		0.01	10	$\mu\text{A}$

**Note**

<sup>(2)</sup> Tolerances:  $\pm 15\%$  for  $I_V$ ,  $\pm 0.1\text{ V}$  for  $V_F$ ,  $\pm 1\text{ nm}$  for  $\lambda_d$

<b>COLOR CLASSIFICATION</b>				
GROUP	DOMINANT WAVELENGTH (nm)			
	AMBER		YELLOW	
	MIN.	MAX.	MIN.	MAX.
2	611	616		
3	616	621	583	586
4			586	589
5			589	592
6			592	595

**Note**

• Wavelengths are tested at a current pulse duration of 25 ms and an accuracy of  $\pm 1\text{ nm}$

<b>LUMINOUS INTENSITY CLASSIFICATION</b>		
GROUP	LUMINOUS INTENSITY (mcd)	
STANDARD	MIN.	MAX.
CA	2800	3550
CB	3550	4500
DA	4500	5600
DB	5600	7100
EA	7100	9000
EB	9000	11 200
FA	11 200	14 000

**Note**

• Luminous intensity is tested at a current pulse duration of 25 ms and an accuracy of  $\pm 15\%$ .  
 The above type numbers represent the order groups which include only a few brightness groups. Only one group will be shipped on each reel (there will be no mixing of two groups on each reel).  
 In order to ensure availability, single brightness groups will not be orderable.  
 In a similar manner for colors where wavelength groups are measured and binned, single wavelength groups will be shipped on any one reel.  
 In order to ensure availability, single wavelength groups will not be orderable

**TYPICAL CHARACTERISTICS** ( $T_{amb} = 25\text{ }^{\circ}\text{C}$ , unless otherwise specified)



Fig. 1 - Maximum Permissible Forward Current vs. Ambient Temperature

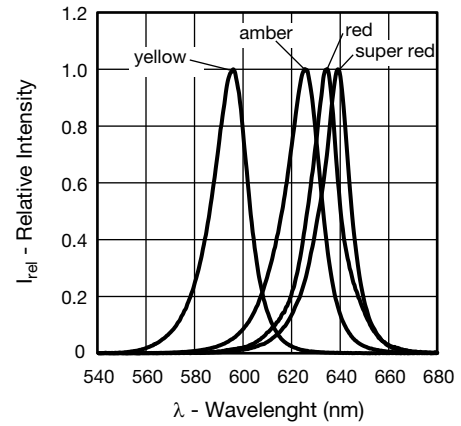

Fig. 4 - Relative Intensity vs. Wavelength

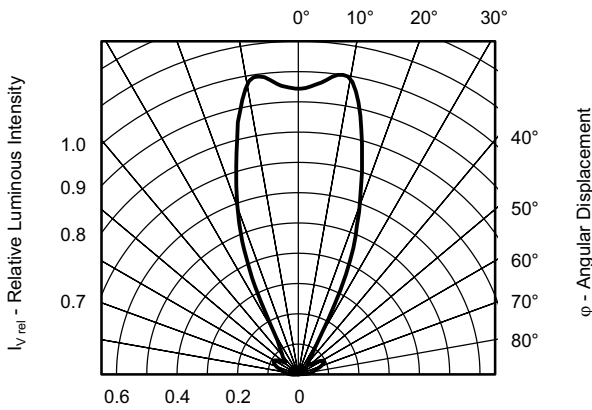

Fig. 2 - Relative Luminous Intensity vs. Angular Displacement

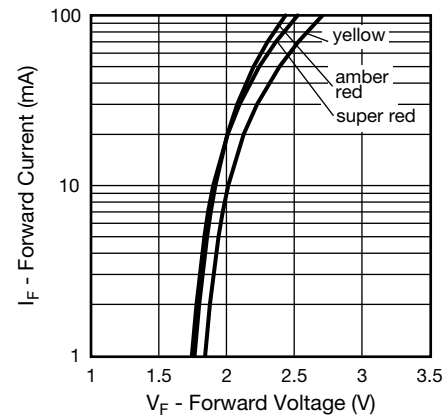

Fig. 5 - Forward Current vs. Forward Voltage

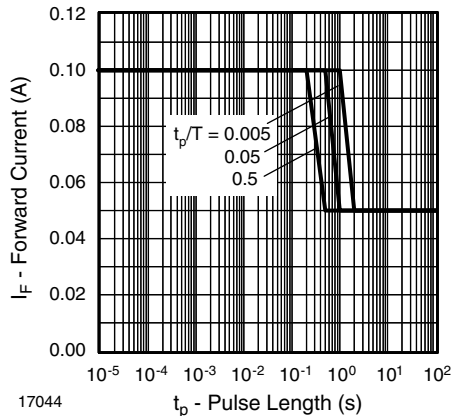

Fig. 3 - Forward Current vs. Pulse Length

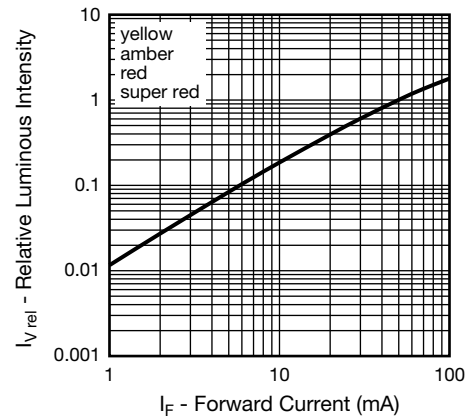

Fig. 6 - Relative Luminous Intensity vs. Forward Current



Fig. 7 - Change of Forward Voltage vs. Ambient Temperature

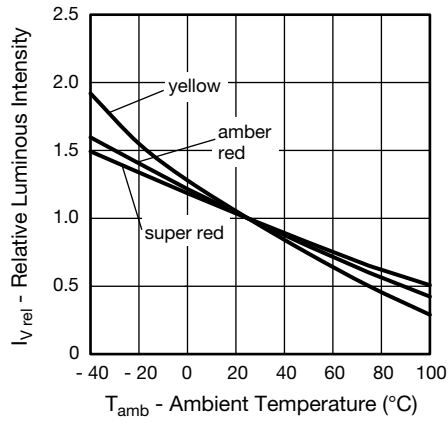

Fig. 8 - Relative Luminous Intensity vs. Ambient Temperature



Fig. 9 - Change of Dominant Wavelength vs. Ambient Temperature



PACKAGE DIMENSIONS in millimeters: **VLD.1535G..** (gullwing)



Technical drawings according to DIN specifications



Not indicated tolerances ± 0.2



Drawing-No.: 6.544-5408.01-4  
Issue: 1; 13.09.12



# VLDS1535., VLDR1535., VLDK1535., VLDY1535..

[www.vishay.com](http://www.vishay.com)

Vishay Semiconductors

**PACKAGE DIMENSIONS** in millimeters: **VLD.1535R..** (reverse gullwing)



Drawing-No.: 6.544-5409.01-4  
Issue: 1; 13.09.12

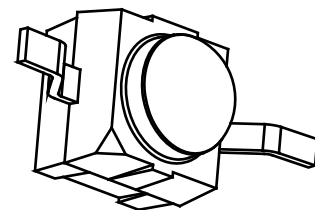

## TAPING AND REEL DIMENSIONS in millimeters: **VLD.1535G..** (gullwing)

### Reel

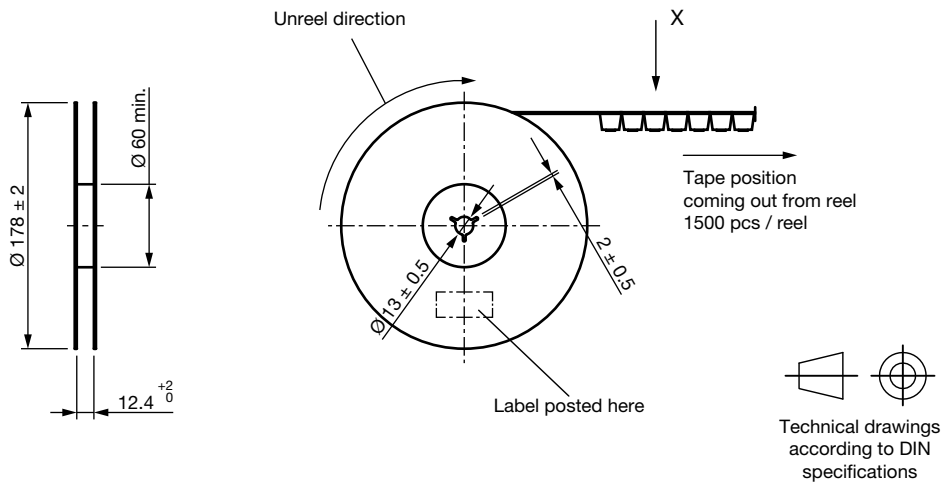

### Leader and trailer tape



### Terminal position in tape

Device	Lead I	Lead II
VLDY153.G...-08	Cathode	Anode
VLDK153.G...-08		
VLDR153.G...-08		
VLDS153.G...-08		



Drawing-No.: 9.800-5137.01-4  
Issue: 1; 17.03.16





**TAPING AND REEL DIMENSIONS** in millimeters: **VLD.1535R..** (reverse gullwing)

Reel



Leader and trailer tape



Terminal position in tape

Device	Lead I	Lead II
VLDY153.R...-08	Cathode	Anode
VLDK153.R...-08		
VLDR153.R...-08		
VLDS153.R...-08		



Drawing-No.: 9.800-5138.01-4  
Issue: 1; 17.03.16

**COVER TAPE PEEL STRENGTH**

According to DIN EN 60286-3  
0.1 N to 1.3 N  
300 ± 10 mm/min  
165° to 180° peel angle

**LABEL**

Standard bar code labels for finished goods  
The standard bar code labels are product labels and used for identification of goods. The finished goods are packed in final packing area. The standard packing units are labeled with standard bar code labels before transported as finished goods to warehouses. The labels are on each packing unit and contain Vishay Semiconductor GmbH specific data.

**SOLDERING PROFILE**



Fig. 10 - Vishay Lead (Pb)-free Reflow Soldering Profile (according to J-STD-020)

**BAR CODE PRODUCT LABEL (example)**

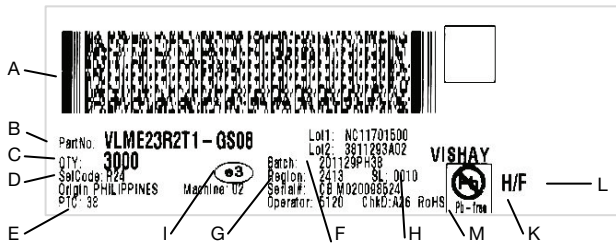

- A. 2D barcode
- B. PartNo = Vishay part number
- C. QTY = quantity
- D. SelCode = selection code (binning)
- E. PTC = code of manufacturing plant
- F. Batch = date code: year / week / plant code
- G. Region code
- H. SL = sales location
- I. Terminations finishing
- J. Lead (Pb)-free symbol
- K. Halogen-free symbol
- L. RoHS symbol

**DRY PACKING**

The reel is packed in an anti-humidity bag to protect the devices from absorbing moisture during transportation and storage.



15973

**FINAL PACKING**

The sealed reel is packed into a cardboard box. A secondary cardboard box is used for shipping purposes.

**RECOMMENDED METHOD OF STORAGE**

Dry box storage is recommended as soon as the aluminum bag has been opened to prevent moisture absorption. The following conditions should be observed, if dry boxes are not available:

- Storage temperature 10 °C to 30 °C
- Storage humidity ≤ 60 % RH max.

After more than 672 h under these conditions moisture content will be too high for reflow soldering.

In case of moisture absorption, the devices will recover to the former condition by drying under the following condition:

- 192 h at 40 °C + 5 °C / - 0 °C and < 5 % RH (dry air / nitrogen) or
- 96 h at 60 °C + 5 °C and < 5 % RH for all device containers or
- 24 h at 100 °C + 5 °C not suitable for reel or tubes.

An EIA JEDEC standard JESD22-A112 level 2a label is included on all dry bags.

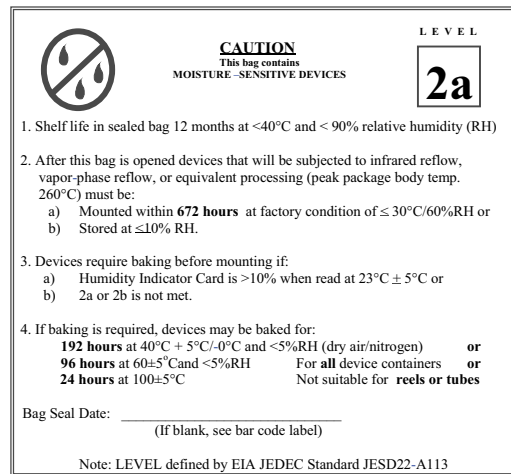

Example of JESD22-A112 level 2a label

**ESD PRECAUTION**

Proper storage and handling procedures should be followed to prevent ESD damage to the devices especially when they are removed from the antistatic shielding bag. Electrostatic sensitive devices warning labels are on the packaging.

**VISHAY SEMICONDUCTORS STANDARD BAR CODE LABEL**

The Vishay Semiconductors standard bar code labels are printed at final packing areas. The labels are on each packing unit and contain Vishay Semiconductors specific data.



## **Disclaimer**

ALL PRODUCT, PRODUCT SPECIFICATIONS AND DATA ARE SUBJECT TO CHANGE WITHOUT NOTICE TO IMPROVE RELIABILITY, FUNCTION OR DESIGN OR OTHERWISE.

Vishay Intertechnology, Inc., its affiliates, agents, and employees, and all persons acting on its or their behalf (collectively, "Vishay"), disclaim any and all liability for any errors, inaccuracies or incompleteness contained in any datasheet or in any other disclosure relating to any product.

Vishay makes no warranty, representation or guarantee regarding the suitability of the products for any particular purpose or the continuing production of any product. To the maximum extent permitted by applicable law, Vishay disclaims (i) any and all liability arising out of the application or use of any product, (ii) any and all liability, including without limitation special, consequential or incidental damages, and (iii) any and all implied warranties, including warranties of fitness for particular purpose, non-infringement and merchantability.

Statements regarding the suitability of products for certain types of applications are based on Vishay's knowledge of typical requirements that are often placed on Vishay products in generic applications. Such statements are not binding statements about the suitability of products for a particular application. It is the customer's responsibility to validate that a particular product with the properties described in the product specification is suitable for use in a particular application. Parameters provided in datasheets and / or specifications may vary in different applications and performance may vary over time. All operating parameters, including typical parameters, must be validated for each customer application by the customer's technical experts. Product specifications do not expand or otherwise modify Vishay's terms and conditions of purchase, including but not limited to the warranty expressed therein.

Except as expressly indicated in writing, Vishay products are not designed for use in medical, life-saving, or life-sustaining applications or for any other application in which the failure of the Vishay product could result in personal injury or death. Customers using or selling Vishay products not expressly indicated for use in such applications do so at their own risk. Please contact authorized Vishay personnel to obtain written terms and conditions regarding products designed for such applications.

No license, express or implied, by estoppel or otherwise, to any intellectual property rights is granted by this document or by any conduct of Vishay. Product names and markings noted herein may be trademarks of their respective owners.

## Данный компонент на территории Российской Федерации

### Вы можете приобрести в компании MosChip.

Для оперативного оформления запроса Вам необходимо перейти по данной ссылке:

<http://moschip.ru/get-element>

Вы можете разместить у нас заказ для любого Вашего проекта, будь то серийное производство или разработка единичного прибора.

В нашем ассортименте представлены ведущие мировые производители активных и пассивных электронных компонентов.

Нашей специализацией является поставка электронной компонентной базы двойного назначения, продукции таких производителей как XILINX, Intel (ex.ALTERA), Vicor, Microchip, Texas Instruments, Analog Devices, Mini-Circuits, Amphenol, Glenair.

Сотрудничество с глобальными дистрибьюторами электронных компонентов, предоставляет возможность заказывать и получать с международных складов практически любой перечень компонентов в оптимальные для Вас сроки.

На всех этапах разработки и производства наши партнеры могут получить квалифицированную поддержку опытных инженеров.

Система менеджмента качества компании отвечает требованиям в соответствии с ГОСТ Р ИСО 9001, ГОСТ РВ 0015-002 и ЭС РД 009

### Офис по работе с юридическими лицами:

105318, г.Москва, ул.Щербаковская д.3, офис 1107, 1118, ДЦ «Щербаковский»

Телефон: +7 495 668-12-70 (многоканальный)

Факс: +7 495 668-12-70 (доб.304)

E-mail: [info@moschip.ru](mailto:info@moschip.ru)

Skype отдела продаж:

moschip.ru

moschip.ru\_4

moschip.ru\_6

moschip.ru\_9