

FA / FS SERIES

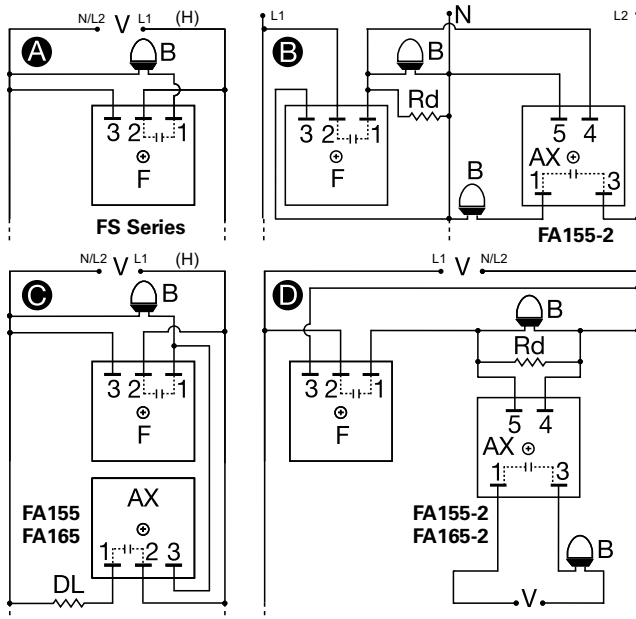

*(FS155 & FA155 models only)

Wiring Diagram



V = Voltage N = Neutral B = Beacon
 DL = Dummy Load for Constant Line Loading
 Rd = 3.3 K Ω @ 5W for 120VAC; 8.5 K Ω @ 5W for 230VAC
 F = Flasher (FS155-30T, FS155-30RF, FS165-30T)
 AX = Auxiliary Unit (FA155, FA155-2, FA165, FA156-2)

Description

The FA/FS Series have proven their reliability through years of use on communication towers, smoke stacks, cooling towers, tall buildings, bridges and utility towers. The highest quality components are encapsulated in a rugged plastic housing with a molded-in heat transfer plate. The flash rate, ratio, and fail-safe design meet FAA regulations. Zero voltage switching can increase lamp life up to ten times. The FS155-30RF includes superior RF filtering circuitry for use in high RF installations, including AM hot towers.

Operation

FS Series - Flasher (OFF First)

FA Series - Auxiliary Modules

Upon application of input voltage, the T2 OFF time begins. At the end of the OFF time, the T1 ON time begins and the load energizes. At the end of T1, T2 begins and the load de-energizes. This cycle repeats until voltage is removed.

Reset: Removing input voltage resets the output and the sequence to T2.

Features & Benefits

FEATURES	BENEFITS
Zero voltage switching	Delivers up to 10 times longer lamp life
Encapsulated	Protects against shock, vibration, and humidity
Metalized mounting surface	Facilitates heat transfer in high current applications
Superior RF filtering circuitry (RF models only)	Ideal for AM hot towers and other high RF installations
High inrush capability up to 200A	Will withstand the repetitive inrush current of incandescent beacons

Ordering Information

MODEL	INPUT VOLTAGE	WATTAGE	INRUSH RATING	DESCRIPTION
FA155	120VAC	2500W	200A	Auxiliary unit to provide constant line loading
FA155-2	120VAC	2500W	200A	Auxiliary unit for synchronized operating of additional beacons. Synchronized flashing of additional beacons on a 3 wire system
FA165	230VAC	5000W	200A	Auxiliary unit to provide constant line loading
FA165-2	230VAC	5000W	200A	Auxiliary unit for synchronized operating of additional beacons. Synchronized flashing of additional beacons on a 2 wire system
FS155-30RF	120VAC	2500W	200A	For high RF interference locations including AM hot towers
FS155-30T	120VAC	2500W	200A	Standard beacon flasher
FS165-30T	230VAC	5000W	200A	Standard beacon flasher

If you don't find the part you need, call us for a custom product 800-843-8848

FA / FS SERIES

Accessories



P1015-13 (AWG 10/12), **P1015-64** (AWG 14/16), **P1015-14** (AWG 18/22) **Female Quick Connect**
These 0.25 in. (6.35 mm) female terminals are constructed with an insulator barrel to provide strain relief.



P1015-18 Quick Connect to Screw Adapter
Screw adapter terminal designed for use with all modules with 0.25 in. (6.35 mm) male quick connect terminals.

Flasher Function Diagrams



V = Voltage
R = Reset
L = Load
T1 = ON Time
T2 = OFF Time
T1 = T2
F = Flasher
DL = Dummy Load
AX = Auxillary Module



Specifications

Operation

Single & multiple beacon flashing with auxiliary modules

Flash Rate (FS Series Only)

30 ±10 FPM

ON/OFF Ratio

(FS Series Only)

50 - 67% ON time; 33 - 50% OFF time

Voltage

120 or 230VAC ±20%

AC Line Frequency

50/60Hz

Output Rating (Zero

Voltage Switching)

2500W @ 120VAC; 5000W @ 230VAC

Inrush Current

200A peak for 1 cycle of AC line

Mounting*

Surface mount with one #10 (M5 x 0.8) screw

Dimensions

H 50.8 mm (2"); **W** 50.8 mm (2");

D 38.4 mm (1.51")

Termination

0.25 in. (6.35 mm) male quick connect terminals

Circuitry

Encapsulated

Operating/Storage

Temperature

-55° to 65°C / -55° to 85°C

Humidity

95% relative, non-condensing

Weight

≈ 3.9 oz (111 g)

* Note: Must be mounted to metal surface using the included heat sink compound. The maximum mounting surface temperature is 90°C.

Данный компонент на территории Российской Федерации

Вы можете приобрести в компании MosChip.

Для оперативного оформления запроса Вам необходимо перейти по данной ссылке:

<http://moschip.ru/get-element>

Вы можете разместить у нас заказ для любого Вашего проекта, будь то серийное производство или разработка единичного прибора.

В нашем ассортименте представлены ведущие мировые производители активных и пассивных электронных компонентов.

Нашей специализацией является поставка электронной компонентной базы двойного назначения, продукции таких производителей как XILINX, Intel (ex.ALTERA), Vicor, Microchip, Texas Instruments, Analog Devices, Mini-Circuits, Amphenol, Glenair.

Сотрудничество с глобальными дистрибьюторами электронных компонентов, предоставляет возможность заказывать и получать с международных складов практически любой перечень компонентов в оптимальные для Вас сроки.

На всех этапах разработки и производства наши партнеры могут получить квалифицированную поддержку опытных инженеров.

Система менеджмента качества компании отвечает требованиям в соответствии с ГОСТ Р ИСО 9001, ГОСТ РВ 0015-002 и ЭС РД 009

Офис по работе с юридическими лицами:

105318, г.Москва, ул.Щербаковская д.3, офис 1107, 1118, ДЦ «Щербаковский»

Телефон: +7 495 668-12-70 (многоканальный)

Факс: +7 495 668-12-70 (доб.304)

E-mail: info@moschip.ru

Skype отдела продаж:

moschip.ru

moschip.ru_4

moschip.ru_6

moschip.ru_9