

Analog Devices Welcomes Hittite Microwave Corporation

NO CONTENT ON THE ATTACHED DOCUMENT HAS CHANGED



THIS PAGE INTENTIONALLY LEFT BLANK

GaAs MMIC SUB-HARMONICALLY PUMPED MIXER, 26 - 33 GHz

Typical Applications

The HMC338 is ideal for:

- General Purpose Applications
- 26 and 33 GHz Microwave Radios
- Up and Down Converter for Point-to-Point Radios
- Satellite Communication Systems

Features

- Integrated LO Amplifier: -5 dBm Input
- Sub-Harmonically Pumped (x2) LO
- High 2LO/RF Isolation: 33 dB
- Die Size: 1.32 x 0.97 x 0.1 mm

Functional Diagram

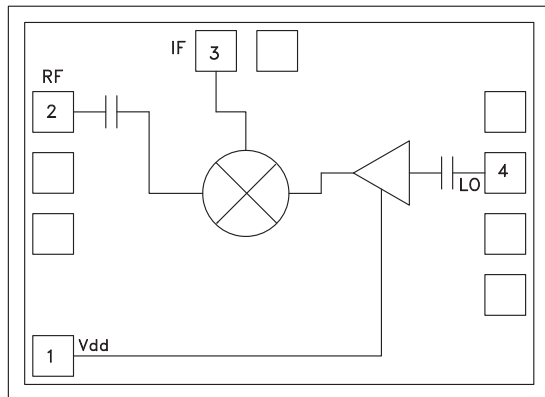

General Description

The HMC338 chip is a general purpose sub-harmonically pumped (x2) MMIC mixer with an integrated LO amplifier which can be used as an upconverter or downconverter in the 26 to 33 GHz frequency range. The chip utilizes a GaAs PHEMT technology that results in a small overall chip area of 1.28mm². The 2LO to RF isolation is excellent eliminating the need for additional filtering. The LO amplifier is a single bias (+3V to +4V) two stage design with only -5 dBm nominal drive requirement. All data is measured with the chip in a 50 ohm test fixture connected via 0.076 mm (3 mil) ribbon bonds of minimal length <0.31 mm (<12 mils).

Electrical Specifications, $T_A = +25^\circ \text{C}$, As a Function of Vdd

Parameter	IF = 1 GHz LO = -5 dBm & Vdd = +4V			IF = 1 GHz LO = -5 dBm & Vdd = +3V			Units
	Min.	Typ.	Max.	Min.	Typ.	Max.	
Frequency Range, RF	26 - 33			27 - 32			GHz
Frequency Range, LO	13 - 16.5			13.5 - 16			GHz
Frequency Range, IF	DC - 2.5			DC - 2.5			GHz
Conversion Loss		9	12		9	12	dB
Noise Figure (SSB)		9	12		9	12	dB
2LO to RF Isolation	18	33		12	30		dB
2LO to IF Isolation	30	40		25	40		dB
IP3 (Input)	5	11		3	9		dBm
1 dB Compression (Input)	-5	2		-5	0		dBm
Supply Current (Idd)		28	50		25	50	mA

*Unless otherwise noted, all measurements performed as downconverter, IF= 1 GHz.

For price, delivery, and to place orders, please contact Hittite Microwave Corporation:
20 Alpha Road, Chelmsford, MA 01824 Phone: 978-250-3343 Fax: 978-250-3373
Order On-line at www.hittite.com

GaAs MMIC SUB-HARMONICALLY PUMPED MIXER, 26 - 33 GHz

Conversion Gain vs. Temperature @ LO = -5 dBm, Vdd = +4V

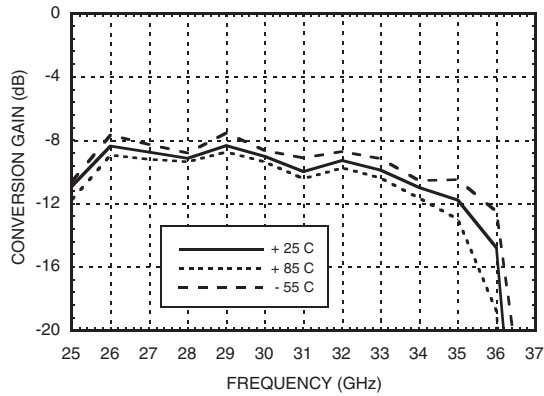

Conversion Gain vs. Temperature @ LO = -5 dBm, Vdd = +3V

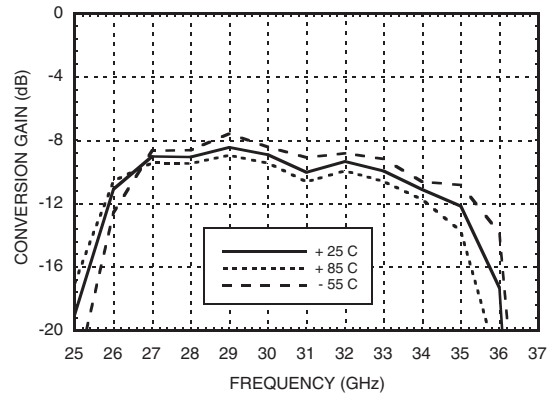

Conversion Gain vs. LO Drive @ Vdd = +4V

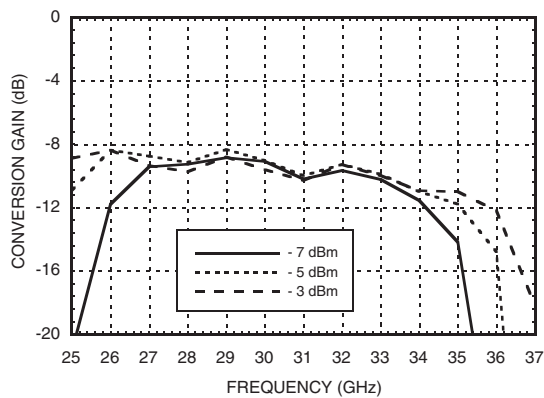

Conversion Gain vs. LO Drive @ Vdd = +3V

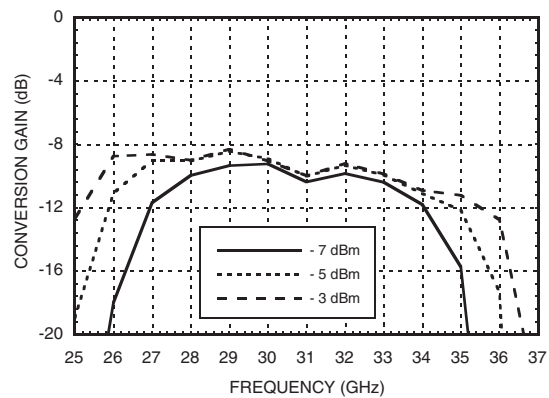

Isolation @ LO = -5 dBm, Vdd = +4V

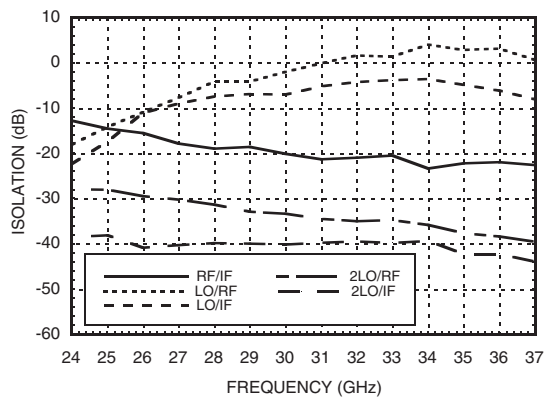

Isolation @ LO = -5 dBm, Vdd = +3V

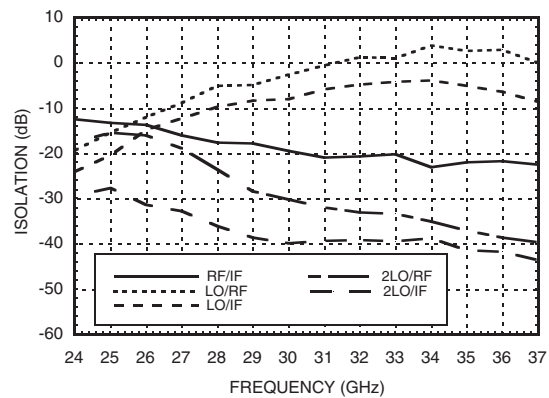

GaAs MMIC SUB-HARMONICALLY PUMPED MIXER, 26 - 33 GHz

Input IP3 vs. LO Drive @ Vdd = +4V*

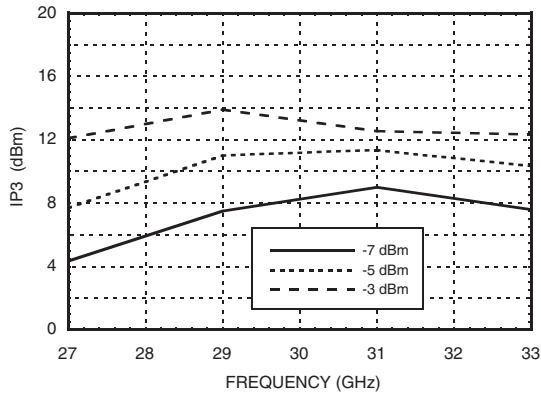

Input IP3 vs. LO Drive @ Vdd = +3V*

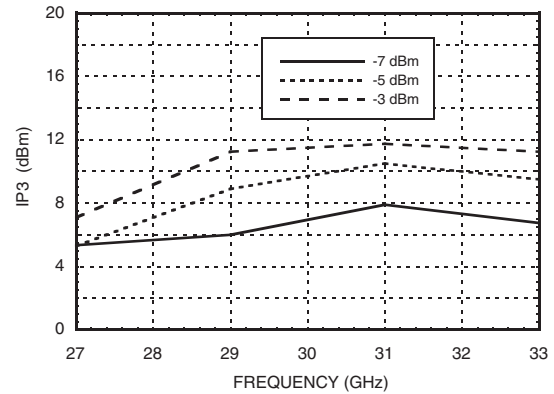

Input IP3 vs. Temperature @ LO = -5 dBm, Vdd = +4V*

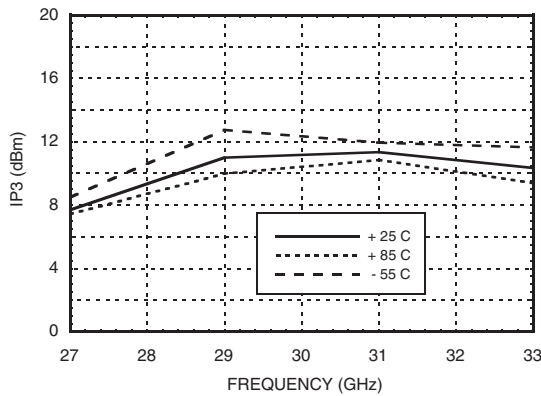

Input IP3 vs. Temperature @ LO = -5 dBm, Vdd = +3V*

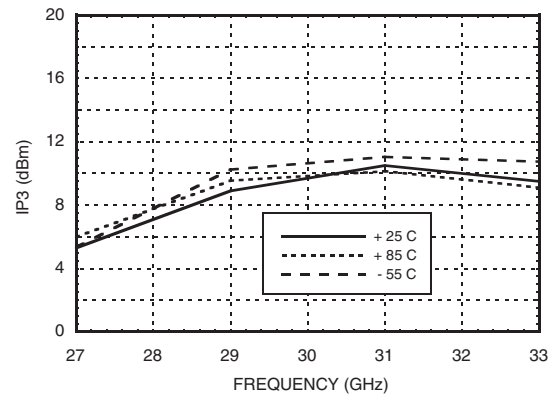

Input IP2 vs. LO Drive @ Vdd = +4V*

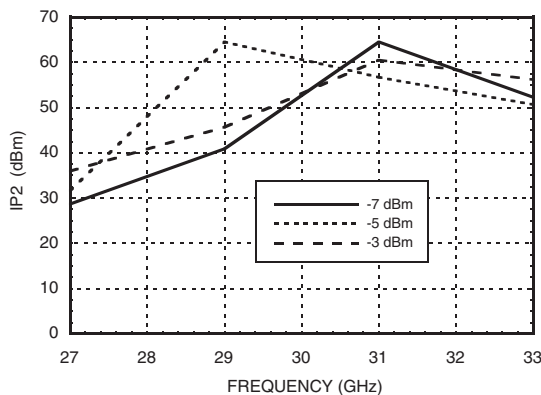

Input IP2 vs. LO Drive @ Vdd = +3V*

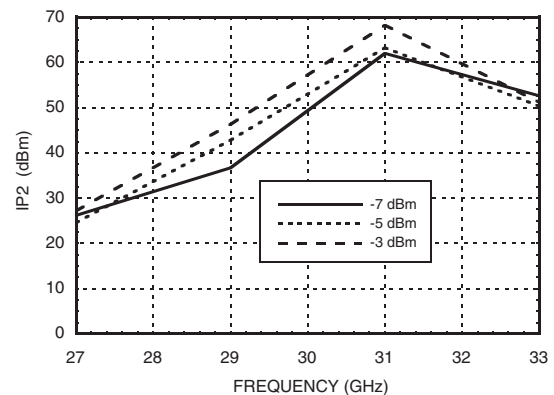

* Two-tone input power = -10 dBm each tone, 1 MHz spacing.

GaAs MMIC SUB-HARMONICALLY PUMPED MIXER, 26 - 33 GHz

Input IP2 vs. Temperature
@ LO = -5 dBm, Vdd = +4V*

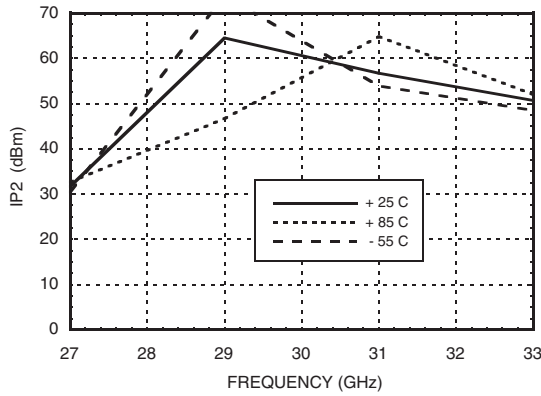

Input IP2 vs. Temperature
@ LO = -5 dBm, Vdd = +3V*

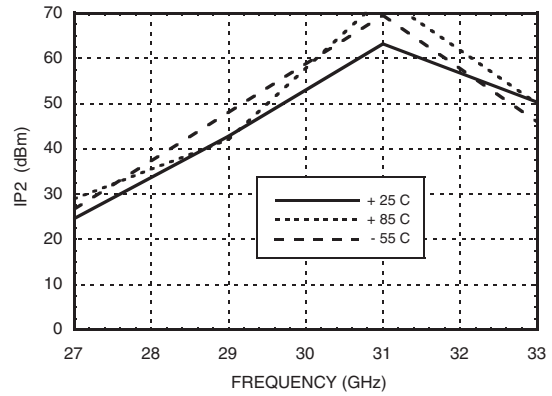

Input P1dB vs. Temperature
@ LO = -5 dBm, Vdd = +4V

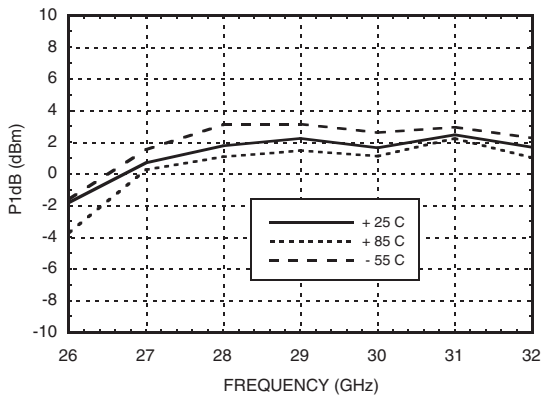

Input P1dB vs. Temperature
@ LO = -5 dBm, Vdd = +3V

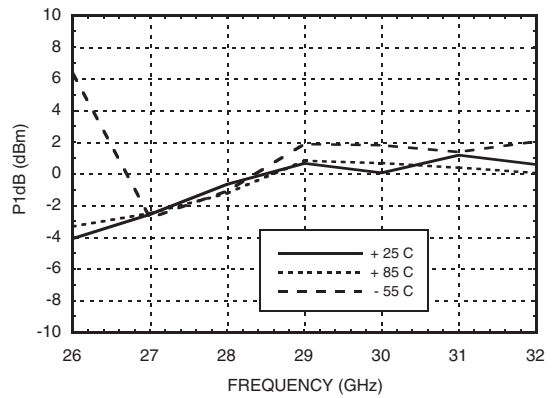

RF & LO Return Loss
@ LO = -5 dBm, Vdd = +4V

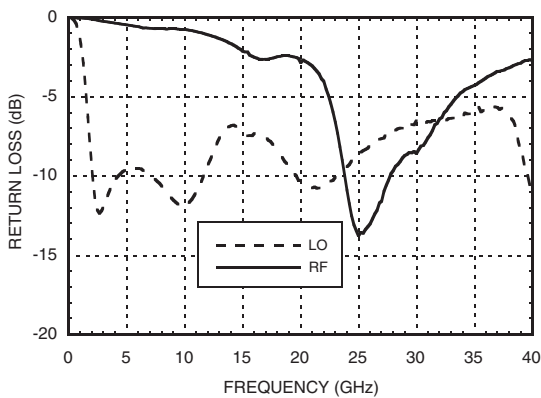

IF Return Loss
@ LO = -5 dBm, Vdd = +4V

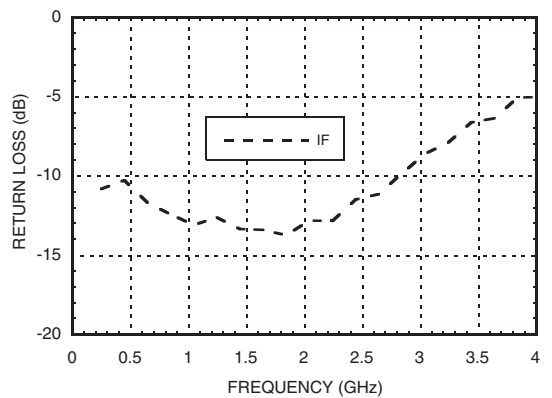

* Two-tone input power = -10 dBm each tone, 1 MHz spacing.

GaAs MMIC SUB-HARMONICALLY PUMPED MIXER, 26 - 33 GHz

IF Bandwidth @ LO = -5 dBm

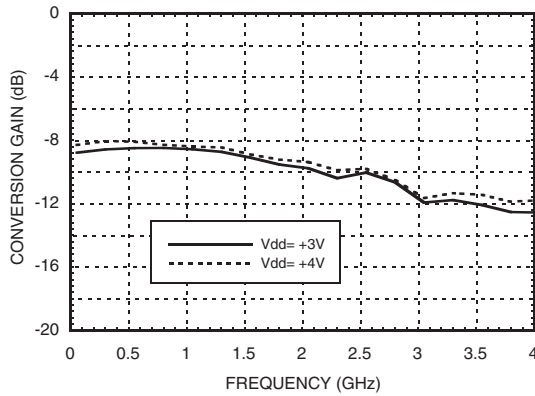

**Upconverter Performance
Conversion Gain, LO = -5 dBm, Vdd = +4V**

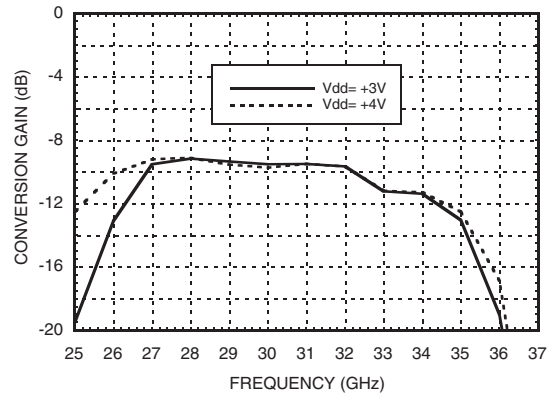

MxN Spurious @ IF Port, Vdd = +4V

mRF	nLO					
	±5	±4	±3	±2	±1	0
-3						
-2	52					
-1	54	35	53			
0			4	28	-8	
1				X	51	13
2		58	51		42	
3	88					

RF = 31 GHz @ -10 dBm
LO = 15 GHz @ -5 dBm
All values in dBc below IF power level.
Measured as downconverter

MxN Spurious @ RF Port, Vdd = +4V

mIF	nLO					
	±5	±4	±3	±2	±1	0
-3				49		
-2			33	55	45	
-1			41	X	43	
0			-5	19	-16	
1			44	X	40	15
2			33	54	36	63
3				47		69

IF = 1 GHz @ -10 dBm
LO = 15 GHz @ -5 dBm
All values in dBc below RF power level.
Measured as upconverter

**GaAs MMIC SUB-HARMONICALLY
PUMPED MIXER, 26 - 33 GHz**

Absolute Maximum Ratings

RF / IF Input (Vdd = +5V)	+13 dBm
LO Drive (Vdd = +5V)	+13 dBm
Vdd	+5.5 Vdc
Continuous P _{diss} (Ta = 85 °C) (derate 2.64 mW/°C above 85 °C)	238 mW
Storage Temperature	-65 to +150 °C
Operating Temperature	-55 to +85 °C



ELECTROSTATIC SENSITIVE DEVICE
OBSERVE HANDLING PRECAUTIONS

3

Outline Drawing

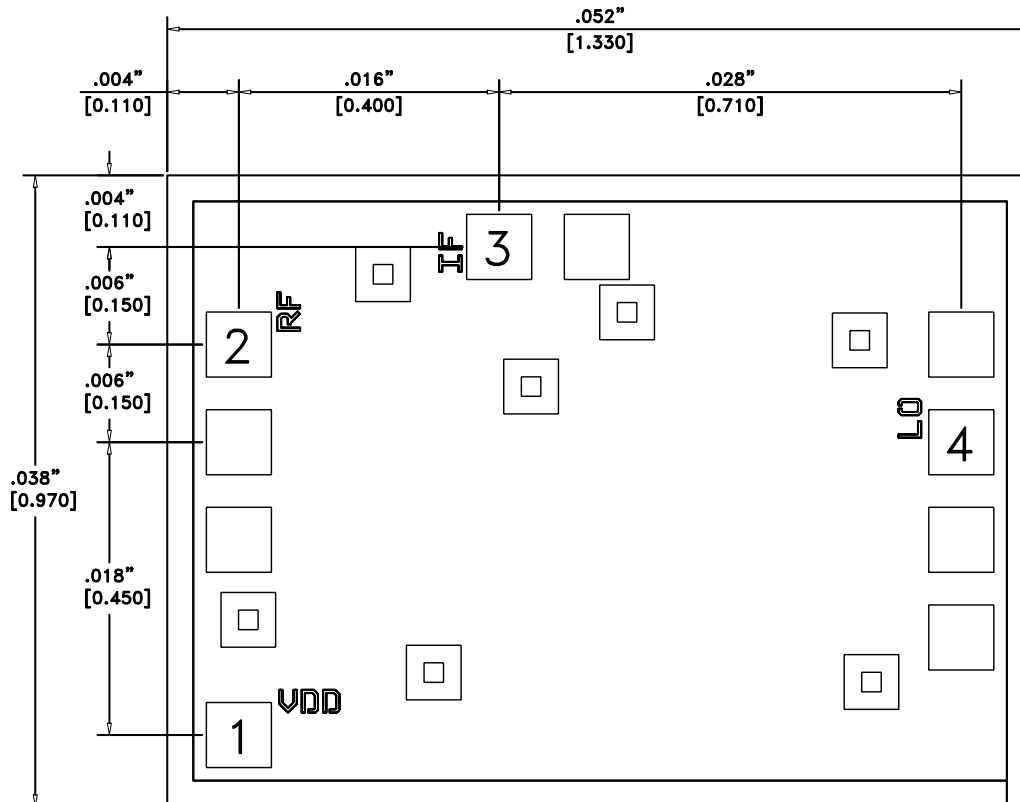

Die Packaging Information [1]

Standard	Alternate
GP-2 (Gel Pack)	[2]

[1] Refer to the "Packaging Information" section for die packaging dimensions.

[2] For alternate packaging information contact Hittite Microwave Corporation.

NOTES:

1. ALL DIMENSIONS IN INCHES (MILLIMETERS)
2. ALL TOLERANCES ARE ± 0.001 (0.025)
3. DIE THICKNESS IS 0.004 (0.100) BACKSIDE IS GROUND
4. BOND PADS ARE 0.004 (0.100) SQUARE
5. BOND PAD SPACING, CTR-CTR: 0.006 (0.150)
6. BACKSIDE METALLIZATION: GOLD
7. BOND PAD METALLIZATION: GOLD

GaAs MMIC SUB-HARMONICALLY PUMPED MIXER, 26 - 33 GHz

Pad Descriptions

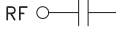
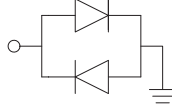
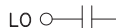
Pad Number	Function	Description	Interface Schematic
1	Vdd	Power supply for the LO Amplifier. An external RF bypass capacitor of 100 - 330 pF is required. A MIM border capacitor is recommended. The bond length to the capacitor should be as short as possible. The ground side of the capacitor should be connected to the housing ground.	
2	RF	This pad is AC coupled and matched to 50 Ohm.	RF 
3	IF	This pad is DC coupled and should be DC blocked externally using a series capacitor whose value has been chosen to pass the necessary IF frequency range. Any applied DC voltage to this pin will result in die non-function and possible die failure.	
4	LO	This pad is AC coupled and matched to 50 Ohm.	LO 

Assembly Diagram

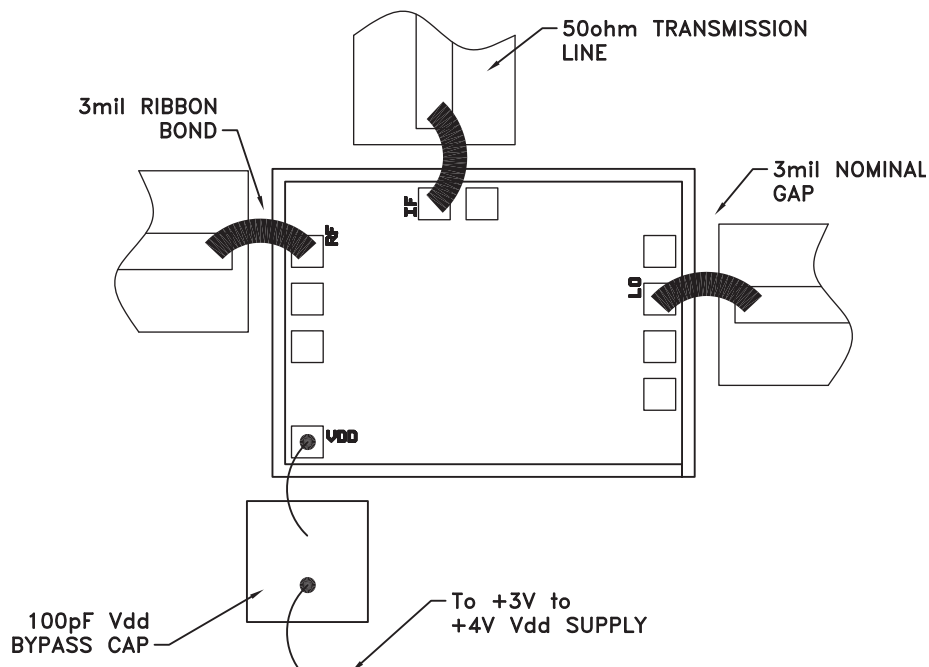

**GaAs MMIC SUB-HARMONICALLY
PUMPED MIXER, 26 - 33 GHz**

Mounting & Bonding Techniques for Millimeterwave GaAs MMICs

The die should be attached directly to the ground plane eutectically or with conductive epoxy (see HMC general Handling, Mounting, Bonding Note).

50 Ohm Microstrip transmission lines on 0.127mm (5 mil) thick alumina thin film substrates are recommended for bringing RF to and from the chip (Figure 1). If 0.254mm (10 mil) thick alumina thin film substrates must be used, the die should be raised 0.150mm (6 mils) so that the surface of the die is coplanar with the surface of the substrate. One way to accomplish this is to attach the 0.102mm (4 mil) thick die to a 0.150mm (6 mil) thick molybdenum heat spreader (moly-tab) which is then attached to the ground plane (Figure 2).

Microstrip substrates should be brought as close to the die as possible in order to minimize ribbon bond length. Typical die-to-substrate spacing is 0.076mm (3 mils). Gold ribbon of 0.075 mm (3 mil) width and minimal length <0.31 mm (<12 mils) is recommended to minimize inductance on RF, LO & IF ports.

An RF bypass capacitor should be used on the Vdd input. A 100 pF single layer capacitor (mounted eutectically or by conductive epoxy) placed no further than 0.762mm (30 Mils) from the chip is recommended.

Handling Precautions

Follow these precautions to avoid permanent damage.

Storage: All bare die are placed in either Waffle or Gel based ESD protective containers, and then sealed in an ESD protective bag for shipment. Once the sealed ESD protective bag has been opened, all die should be stored in a dry nitrogen environment.

Cleanliness: Handle the chips in a clean environment. DO NOT attempt to clean the chip using liquid cleaning systems.

Static Sensitivity: Follow ESD precautions to protect against ESD strikes.

Transients: Suppress instrument and bias supply transients while bias is applied. Use shielded signal and bias cables to minimize inductive pick-up.

General Handling: Handle the chip along the edges with a vacuum collet or with a sharp pair of bent tweezers. The surface of the chip has fragile air bridges and should not be touched with vacuum collet, tweezers, or fingers.

Mounting

The chip is back-metallized and can be die mounted with AuSn eutectic preforms or with electrically conductive epoxy. The mounting surface should be clean and flat.

Eutectic Die Attach: A 80/20 gold tin preform is recommended with a work surface temperature of 255 °C and a tool temperature of 265 °C. When hot 90/10 nitrogen/hydrogen gas is applied, tool tip temperature should be 290 °C. DO NOT expose the chip to a temperature greater than 320 °C for more than 20 seconds. No more than 3 seconds of scrubbing should be required for attachment.

Epoxy Die Attach: Apply a minimum amount of epoxy to the mounting surface so that a thin epoxy fillet is observed around the perimeter of the chip once it is placed into position. Cure epoxy per the manufacturer's schedule.

Wire Bonding

RF bonds made with 0.003" x 0.0005" ribbon are recommended. These bonds should be thermosonically bonded with a force of 40-60 grams. DC bonds of 0.001" (0.025 mm) diameter, thermosonically bonded, are recommended. Ball bonds should be made with a force of 40-50 grams and wedge bonds at 18-22 grams. All bonds should be made with a nominal stage temperature of 150 °C. A minimum amount of ultrasonic energy should be applied to achieve reliable bonds. All bonds should be as short as possible, less than 12 mils (0.31 mm).

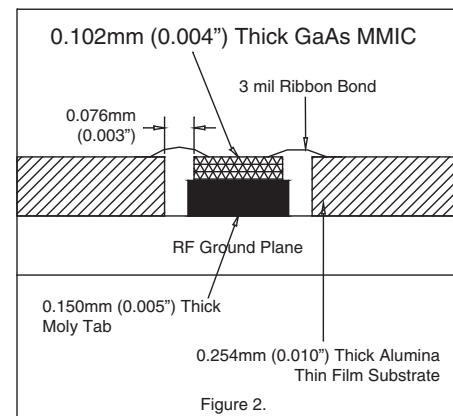
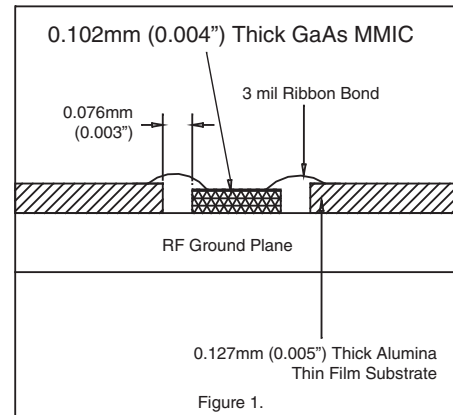

Данный компонент на территории Российской Федерации

Вы можете приобрести в компании MosChip.

Для оперативного оформления запроса Вам необходимо перейти по данной ссылке:

<http://moschip.ru/get-element>

Вы можете разместить у нас заказ для любого Вашего проекта, будь то серийное производство или разработка единичного прибора.

В нашем ассортименте представлены ведущие мировые производители активных и пассивных электронных компонентов.

Нашей специализацией является поставка электронной компонентной базы двойного назначения, продукции таких производителей как XILINX, Intel (ex.ALTERA), Vicor, Microchip, Texas Instruments, Analog Devices, Mini-Circuits, Amphenol, Glenair.

Сотрудничество с глобальными дистрибьюторами электронных компонентов, предоставляет возможность заказывать и получать с международных складов практически любой перечень компонентов в оптимальные для Вас сроки.

На всех этапах разработки и производства наши партнеры могут получить квалифицированную поддержку опытных инженеров.

Система менеджмента качества компании отвечает требованиям в соответствии с ГОСТ Р ИСО 9001, ГОСТ РВ 0015-002 и ЭС РД 009

Офис по работе с юридическими лицами:

105318, г.Москва, ул.Щербаковская д.3, офис 1107, 1118, ДЦ «Щербаковский»

Телефон: +7 495 668-12-70 (многоканальный)

Факс: +7 495 668-12-70 (доб.304)

E-mail: info@moschip.ru

Skype отдела продаж:

moschip.ru

moschip.ru_4

moschip.ru_6

moschip.ru_9