

Frequency Synthesizer

KSN-1932A-119+

50Ω 1832 to 1932 MHz

The Big Deal

- Fractional N synthesizer
- Low phase noise and spurious
- Robust design and construction
- Small size 0.800" x 0.584" x 0.240"



CASE STYLE: DK1182

Product Overview

The KSN-1932A-119+ is a Frequency Synthesizer, designed to operate from 1832 to 1932 MHz for WiMAX application. The KSN-1932A-119+ is packaged in a metal case (size of 0.800" x 0.584" x 0.240") to shield against unwanted signals and noise.

Key Features

Feature	Advantages
Low phase noise and spurious: <ul style="list-style-type: none">• Phase Noise: -108 dBc/Hz typ. @10 kHz offset• Step Size Spurious: -87 dBc typ.• Comparison Spurious: -92 dBc typ.• Reference Spurious: -90 dBc typ.	Low phase noise and spurious improve system EVM (Error Vector Magnitude).
Robust design and construction	To enhance the robustness of KSN-1932A-119+, each internal component is secured to the substrate with chip bonder, thereby eliminating the risk of tombstoning during subsequent solder reflow operations by the customer.
Small size, 0.800" x 0.584" x 0.240"	The small size enables the KSN-1932A-119+ to be used in compact designs.



IF/RF MICROWAVE COMPONENTS • ISO 9001 ISO 14001 AS9100 CERTIFIED RoHS compliant
P.O. Box 350166, Brooklyn, New York 11235-0003 (718) 934-4500 Fax (718) 332-4661



The Design Engineers Search Engine finds the model you need, Instantly • For detailed performance specs & shopping online see



Notes: 1. Performance and quality attributes and conditions not expressly stated in this specification sheet are intended to be excluded and do not form a part of this specification sheet. 2. Electrical specifications and performance data contained herein are based on Mini-Circuit's applicable established test performance criteria and measurement instructions. 3. The parts covered by this specification sheet are subject to Mini-Circuits standard limited warranty and terms and conditions (collectively, "Standard Terms"); Purchasers of this part are entitled to the rights and benefits contained therein. For a full statement of the Standard Terms and the exclusive rights and remedies thereunder, please visit Mini-Circuits' website at www.minicircuits.com/MCLStore/terms.jsp.

Frequency Synthesizer

KSN-1932A-119+

50Ω 1832 to 1932 MHz

Features

- Fractional N synthesizer
- Integrated VCO + PLL
- Low phase noise and spurious
- Robust design and construction
- Low operating voltage (VCC VCO=+5V, VCC PLL=+3V)
- Small size 0.800" x 0.584" x 0.240"



CASE STYLE: DK1182
PRICE: \$29.95 ea. QTY (1-9)

+ RoHS compliant in accordance with EU Directive (2002/95/EC)

The +Suffix has been added in order to identify RoHS Compliance. See our web site for RoHS Compliance methodologies and qualifications.

Applications

- WiMAX

General Description

The KSN-1932A-119+ is a Frequency Synthesizer, designed to operate from 1832 to 1932 MHz for WiMAX application. The KSN-1932A-119+ is packaged in a metal case (size of 0.800" x 0.584" x 0.240) to shield against unwanted signals and noise. To enhance the robustness of KSN-1932A-119+, each internal component is secured to the substrate with chip bonder, thereby eliminating the risk of tombstoning during subsequent solder reflow operations by the customer.

Simplified Schematic



IF/RF MICROWAVE COMPONENTS • ISO 9001 ISO 14001 AS9100 CERTIFIED RoHS compliant
P.O. Box 350166, Brooklyn, New York 11235-0003 (718) 934-4500 Fax (718) 332-4661



The Design Engineers Search Engine finds the model you need, Instantly • For detailed performance specs & shopping online see



Notes: 1. Performance and quality attributes and conditions not expressly stated in this specification sheet are intended to be excluded and do not form a part of this specification sheet. 2. Electrical specifications and performance data contained herein are based on Mini-Circuit's applicable established test performance criteria and measurement instructions. 3. The parts covered by this specification sheet are subject to Mini-Circuits standard limited warranty and terms and conditions (collectively, "Standard Terms"); Purchasers of this part are entitled to the rights and benefits contained therein. For a full statement of the Standard Terms and the exclusive rights and remedies thereunder, please visit Mini-Circuits' website at www.minicircuits.com/MCLStore/terms.jsp.

Electrical Specifications (over operating temperature -40°C to +85°C)

Parameters	Test Conditions	Min.	Typ.	Max.	Units
Frequency Range	-	1832	-	1932	MHz
Step Size	-	-	125	-	kHz
Comparison Frequency	-	-	13	-	MHz
Settling Time	Within ± 1 kHz	-	25	-	mSec
Output Power	-	0	+3	+6	dBm
SSB Phase Noise	@ 100 Hz offset	-	-80	-	dBc/Hz
	@ 1 kHz offset	-	-87	-78	
	@ 10 kHz offset	-	-108	-100	
	@ 100 kHz offset	-	-130	-125	
	@ 1 MHz offset	-	-150	-145	
Integrated SSB Phase Noise	@ 100 Hz to 5MHz	-	-48	-	dBc
Step Size Spurious Suppression	Step Size 125 kHz	-	-87	-70	dBc
0.5 Step Size Spurious Suppression	0.5 Step Size 62.5 kHz	-	-85	-70	
Reference Spurious Suppression	Ref. Freq. 52 MHz	-	-90	-80	
Comparison Spurious Suppression	Comp. Freq. 13 MHz	-	-92	-80	
Non - Harmonic Spurious Suppression	-	-	-90	-	
Harmonic Suppression	-	-	-28	-20	
VCO Supply Voltage	5.00	4.75	5.00	5.25	V
PLL Supply Voltage	3.00	2.85	3.00	3.15	
VCO Supply Current	-	-	43	51	mA
PLL Supply Current	-	-	15	22	
Reference Input (External)	Frequency	52 (square wave)	-	52	MHz
	Amplitude	1	-	1	V _{P-P}
	Input impedance	-	-	100	KΩ
	Phase Noise @ 1 kHz offset	-	-	-130	dBc/Hz
RF Output port Impedance	-	-	50	-	Ω
Input Logic Level	Input high voltage	-	2.55	-	V
	Input low voltage	-	-	0.55	V
Digital Lock Detect	Locked	-	2.45	3.15	V
	Unlocked	-	-	0.40	V
Frequency Synthesizer PLL	-	ADF4153			
PLL Programming	-	3-wire serial 3V CMOS			
Register Map @ 1932 MHz	R0_Register	-	(MSB) 001001010000000100000000 (LSB)		
	R1_Register	-	(MSB) 000101010000000110100001 (LSB)		
	R2_Register	-	(MSB) 0000000000000001001100010 (LSB)		
	R3_Register	-	(MSB) 0000000000000001111000111 (LSB)		

Absolute Maximum Ratings

Parameters	Ratings
VCO Supply Voltage	5.8V
PLL Supply Voltage	4.0V
VCO Supply Voltage to PLL Supply Voltage	-0.3V to +5.8V
Reference Frequency Voltage	-0.3Vmin, VCC PLL +0.3Vmax
Data, Clock, LE Levels	-0.3Vmin, VCC PLL +0.3Vmax
Operating Temperature	-40°C to +85°C
Storage Temperature	-55°C to +100°C

Permanent damage may occur if any of these limits are exceeded



IF/RF MICROWAVE COMPONENTS • ISO 9001 ISO 14001 AS9100 CERTIFIED RoHS compliant
 P.O. Box 350166, Brooklyn, New York 11235-0003 (718) 934-4500 Fax (718) 332-4661
 The Design Engineers Search Engine finds the model you need, Instantly • For detailed performance specs & shopping online see minicircuits.com

Notes: 1. Performance and quality attributes and conditions not expressly stated in this specification sheet are intended to be excluded and do not form a part of this specification sheet. 2. Electrical specifications and performance data contained herein are based on Mini-Circuit's applicable established test performance criteria and measurement instructions. 3. The parts covered by this specification sheet are subject to Mini-Circuits standard limited warranty and terms and conditions (collectively, "Standard Terms"); Purchasers of this part are entitled to the rights and benefits contained therein. For a full statement of the Standard Terms and the exclusive rights and remedies thereunder, please visit Mini-Circuits' website at www.minicircuits.com/MCLStore/terms.jsp.

Typical Performance Data

FREQUENCY (MHz)	POWER OUTPUT (dBm)			VCO CURRENT (mA)			PLL CURENT (mA)		
	-45°C	+25°C	+85°C	-45°C	+25°C	+85°C	-45°C	+25°C	+85°C
1832.00	2.53	2.94	2.95	40.53	43.04	44.51	12.68	14.64	16.76
1844.00	2.46	2.99	3.01	40.58	43.07	44.50	12.73	14.73	16.81
1856.00	2.65	2.96	3.02	40.57	43.03	44.44	12.82	14.82	16.90
1868.00	2.78	3.14	3.14	40.54	42.99	44.39	12.82	14.84	16.91
1880.00	2.80	3.17	3.23	40.54	42.95	44.33	12.88	14.90	16.96
1892.00	2.81	3.19	3.28	40.52	42.90	44.26	12.82	14.85	16.90
1904.00	2.85	3.22	3.26	40.46	42.81	44.16	12.92	14.96	17.00
1916.00	2.83	3.12	3.21	40.37	42.69	44.03	12.94	14.98	17.03
1928.00	2.90	3.14	3.17	40.23	42.53	43.89	12.88	14.91	16.96
1932.00	2.93	3.13	3.15	40.18	42.47	43.83	12.83	14.87	16.91

FREQUENCY (MHz)	HARMONICS (dBc)					
	F2			F3		
	-45°C	+25°C	+85°C	-45°C	+25°C	+85°C
1832.00	-38.64	-39.68	-38.81	-27.86	-27.68	-28.63
1844.00	-37.62	-39.28	-38.79	-27.49	-27.42	-28.58
1856.00	-36.70	-38.19	-37.46	-27.74	-26.89	-27.86
1868.00	-35.95	-38.42	-38.07	-28.12	-28.23	-29.17
1880.00	-35.63	-38.34	-39.42	-26.79	-27.33	-28.29
1892.00	-36.31	-38.69	-38.90	-27.78	-27.76	-28.46
1904.00	-35.52	-38.66	-39.33	-28.03	-28.35	-28.99
1916.00	-33.51	-37.04	-38.99	-27.56	-27.64	-28.15
1928.00	-33.63	-36.63	-40.75	-27.32	-26.99	-27.44
1932.00	-33.61	-36.67	-40.99	-27.60	-27.42	-27.78



IF/RF MICROWAVE COMPONENTS • ISO 9001 ISO 14001 AS9100 CERTIFIED RoHS compliant
 P.O. Box 350166, Brooklyn, New York 11235-0003 (718) 934-4500 Fax (718) 332-4661



The Design Engineers Search Engine finds the model you need, Instantly • For detailed performance specs & shopping online see



Notes: 1. Performance and quality attributes and conditions not expressly stated in this specification sheet are intended to be excluded and do not form a part of this specification sheet. 2. Electrical specifications and performance data contained herein are based on Mini-Circuit's applicable established test performance criteria and measurement instructions. 3. The parts covered by this specification sheet are subject to Mini-Circuits standard limited warranty and terms and conditions (collectively, "Standard Terms"); Purchasers of this part are entitled to the rights and benefits contained therein. For a full statement of the Standard Terms and the exclusive rights and remedies thereunder, please visit Mini-Circuits' website at www.minicircuits.com/MCLStore/terms.jsp.

FREQUENCY (MHz)	PHASE NOISE (dBc/Hz) @ OFFSETS				
	+25°C				
	100Hz	1kHz	10kHz	100kHz	1MHz
1832.00	-84.44	-89.89	-110.02	-133.28	-151.42
1844.00	-85.15	-90.77	-109.86	-133.05	-152.76
1856.00	-84.65	-89.61	-109.73	-132.81	-152.58
1868.00	-81.11	-89.06	-109.60	-132.83	-153.60
1880.00	-80.86	-87.99	-108.24	-132.47	-153.14
1892.00	-84.04	-87.01	-108.06	-132.55	-152.50
1904.00	-81.35	-89.77	-107.82	-132.07	-152.40
1916.00	-83.77	-89.32	-107.50	-131.71	-152.23
1928.00	-80.86	-88.06	-107.31	-130.52	-150.12
1932.00	-82.25	-87.53	-107.18	-130.33	-150.10

FREQUENCY (MHz)	PHASE NOISE (dBc/Hz) @ OFFSETS				
	-45°C				
	100Hz	1kHz	10kHz	100kHz	1MHz
1832.00	-84.97	-92.64	-109.64	-133.29	-153.30
1844.00	-84.08	-90.48	-109.12	-133.24	-153.30
1856.00	-86.29	-90.55	-108.55	-132.87	-153.20
1868.00	-81.88	-91.46	-108.61	-132.63	-152.26
1880.00	-84.70	-90.89	-108.86	-133.15	-153.62
1892.00	-85.25	-90.71	-108.06	-133.17	-152.23
1904.00	-83.73	-90.07	-108.38	-133.26	-153.58
1916.00	-85.24	-89.56	-108.68	-132.87	-153.50
1928.00	-84.23	-88.42	-107.84	-131.86	-152.07
1932.00	-84.03	-88.32	-106.77	-131.09	-151.66

FREQUENCY (MHz)	PHASE NOISE (dBc/Hz) @ OFFSETS				
	+85°C				
	100Hz	1kHz	10kHz	100kHz	1MHz
1832.00	-86.06	-88.60	-109.73	-132.32	-150.90
1844.00	-86.47	-88.13	-109.49	-131.88	-152.58
1856.00	-87.35	-88.31	-109.11	-131.78	-152.19
1868.00	-85.82	-88.19	-108.48	-131.07	-151.69
1880.00	-88.22	-87.65	-108.37	-131.38	-151.96
1892.00	-86.29	-86.81	-107.47	-131.19	-151.31
1904.00	-88.60	-86.51	-107.64	-130.85	-151.27
1916.00	-87.35	-86.05	-106.62	-130.33	-150.68
1928.00	-82.50	-84.99	-106.66	-129.51	-149.75
1932.00	-83.51	-83.45	-106.46	-129.24	-149.41



IF/RF MICROWAVE COMPONENTS • ISO 9001 ISO 14001 AS9100 CERTIFIED RoHS compliant
 P.O. Box 350166, Brooklyn, New York 11235-0003 (718) 934-4500 Fax (718) 332-4661



The Design Engineers Search Engine finds the model you need, Instantly • For detailed performance specs & shopping online see



Notes: 1. Performance and quality attributes and conditions not expressly stated in this specification sheet are intended to be excluded and do not form a part of this specification sheet. 2. Electrical specifications and performance data contained herein are based on Mini-Circuit's applicable established test performance criteria and measurement instructions. 3. The parts covered by this specification sheet are subject to Mini-Circuits standard limited warranty and terms and conditions (collectively, "Standard Terms"); Purchasers of this part are entitled to the rights and benefits contained therein. For a full statement of the Standard Terms and the exclusive rights and remedies thereunder, please visit Mini-Circuits' website at www.minicircuits.com/MCLStore/terms.jsp.

COMPARISON SPURIOUS ORDER	COMPARISON SPURIOUS @Fcarrier 1832MHz+(n*Fcomparison) (dBc) note 1			COMPARISON SPURIOUS @Fcarrier 1882MHz+(n*Fcomparison) (dBc) note 1			COMPARISON SPURIOUS @Fcarrier 1932MHz+(n*Fcomparison) (dBc) note 1		
	n	-45°C	+25°C	+85°C	-45°C	+25°C	+85°C	-45°C	+25°C
-5	-94.91	-95.98	-107.30	-99.70	112.93	-107.84	-101.51	-115.01	-106.45
-4	-103.10	-105.16	-102.90	-101.66	99.70	-99.64	-98.14	-99.07	-104.95
-3	-113.39	-99.52	-98.25	-102.07	95.17	-97.68	-98.27	-101.35	-106.11
-2	-100.12	-100.40	-95.78	-95.98	92.36	-97.72	-98.99	-94.50	-107.14
-1	-96.48	-102.37	-96.71	-93.93	92.72	-99.47	-99.67	-92.15	-103.61
0 note 2	-	-	-	-	-	-	-	-	-
+1	-98.93	-99.68	-100.69	-98.81	94.28	-100.91	-103.25	-96.24	-104.88
+2	-99.02	-112.73	-98.00	-106.20	96.03	-97.56	-102.88	-95.45	-109.77
+3	-97.01	-113.36	-98.15	-100.98	101.80	-94.63	-96.07	-101.15	-102.97
+4	-97.09	-98.32	-93.66	-91.33	102.38	-92.88	-94.46	-98.61	-93.16
+5	-106.72	-99.64	-101.23	-94.98	106.75	-102.56	-96.25	-97.82	-96.90

Note 1: Comparison frequency 13 MHz
 Note 2: All spurs are referenced to carrier signal (n=0).

REFERENCE SPURIOUS ORDER	REFERENCE SPURIOUS @Fcarrier 1832MHz+(n*Frefernce) (dBc) note 3			REFERENCE SPURIOUS @Fcarrier 1882MHz+(n*Frefernce) (dBc) note 3			REFERENCE SPURIOUS @Fcarrier 1932MHz+(n*Frefernce) (dBc) note 3		
	n	-45°C	+25°C	+85°C	-45°C	+25°C	+85°C	-45°C	+25°C
-5	-94.82	-105.09	-102.08	-101.67	-100.42	-93.46	-96.55	-99.34	-103.05
-4	-102.20	-97.34	-100.86	-92.70	-100.93	-98.33	-91.66	-92.95	-95.76
-3	-94.38	-101.44	-100.63	-95.31	-92.24	-91.21	-90.70	-98.95	-102.48
-2	-93.77	-98.34	-98.41	-104.07	-95.89	-96.09	-99.11	-95.44	-103.03
-1	-98.34	-104.63	-99.45	-101.81	-100.50	-99.60	-96.43	-99.60	-103.36
0 note 4	-	-	-	-	-	-	-	-	-
+1	-101.18	-98.85	-93.33	-89.96	-101.87	-91.14	-100.52	-98.46	-93.43
+2	-108.10	-97.76	-97.18	-101.76	-98.82	-109.69	-101.68	-95.57	-98.34
+3	-92.91	-95.69	-101.93	-92.68	-91.70	-99.02	-96.60	-103.67	-104.06
+4	-103.48	-99.84	-100.94	-99.98	-104.14	-109.77	-98.79	-105.10	-103.57
+5	-108.83	-114.85	-102.73	-107.48	-107.02	-104.35	-96.67	-102.53	-104.56

Note 3: Reference frequency 52 MHz
 Note 4: All spurs are referenced to carrier signal (n=0).



IF/RF MICROWAVE COMPONENTS • ISO 9001 ISO 14001 AS9100 CERTIFIED RoHS compliant
 P.O. Box 350166, Brooklyn, New York 11235-0003 (718) 934-4500 Fax (718) 332-4661



The Design Engineers Search Engine finds the model you need, Instantly • For detailed performance specs & shopping online see minicircuits.com

Notes: 1. Performance and quality attributes and conditions not expressly stated in this specification sheet are intended to be excluded and do not form a part of this specification sheet. 2. Electrical specifications and performance data contained herein are based on Mini-Circuit's applicable established test performance criteria and measurement instructions. 3. The parts covered by this specification sheet are subject to Mini-Circuits standard limited warranty and terms and conditions (collectively, "Standard Terms"); Purchasers of this part are entitled to the rights and benefits contained therein. For a full statement of the Standard Terms and the exclusive rights and remedies thereunder, please visit Mini-Circuits' website at www.minicircuits.com/MCLStore/terms.jsp.

STEP SIZE SPURIOUS ORDER n	0.5 STEP SIZE & STEP SIZE SPURIOUS @Fcarrier 1832MHz+(n*Fstep size) (dBc) note 5			0.5 STEP SIZE & STEP SIZE SPURIOUS @Fcarrier 1882MHz+(n*Fstep size) (dBc) note 5			0.5 STEP SIZE & STEP SIZE SPURIOUS @Fcarrier 1932MHz+(n*Fstep size) (dBc) note 5		
	-45°C	+25°C	+85°C	-45°C	+25°C	+85°C	-45°C	+25°C	+85°C
-5.0	-112.64	-110.56	-108.09	-108.27	-110.99	-111.95	-112.59	-110.47	-113.61
-4.5	-108.08	-108.16	-112.49	-109.86	-112.44	-108.50	-109.74	-110.80	-111.64
-4.0	-111.46	-108.14	-105.08	-110.06	-109.02	-109.57	-107.47	-111.03	-107.12
-3.5	-109.44	-105.47	-109.71	-108.68	-108.59	-108.02	-107.10	-107.13	-110.14
-3.0	-106.13	-104.03	-107.36	-103.27	-104.98	-107.68	-107.06	-104.72	-107.96
-2.5	-101.54	-103.61	-102.07	-104.84	-103.60	-100.25	-100.66	-102.65	-101.52
-2.0	-96.92	-99.83	-100.49	-100.07	-100.30	-99.58	-98.58	-100.03	-95.72
-1.5	-94.26	-95.39	-95.76	-95.22	-95.48	-92.99	-95.11	-93.41	-95.77
-1.0	-87.55	-88.29	-89.85	-86.71	-89.38	-89.41	-86.10	-88.75	-88.02
-0.5	-86.05	-86.32	-85.97	-86.94	-86.09	-86.06	-86.43	-86.51	-85.94
0 note 6	-	-	-	-	-	-	-	-	-
+0.5	-86.36	-86.90	-86.11	-86.84	-85.94	-86.69	-85.18	-87.49	-85.97
+1.0	-86.37	-87.81	-88.88	-85.27	-89.04	-86.81	-87.85	-86.73	-89.61
+1.5	-94.26	-96.41	-93.34	-94.99	-94.63	-96.02	-93.86	-95.04	-94.53
+2.0	-99.59	-101.23	-99.84	-99.43	-101.70	-98.07	-100.84	-99.84	-97.50
+2.5	-100.78	-103.49	-96.56	-101.28	-102.62	-103.62	-102.17	-101.44	-104.25
+3.0	-103.00	-107.65	-106.72	-105.60	-109.58	-106.78	-105.05	-107.43	-107.18
+3.5	-110.13	-110.13	-103.65	-105.82	-108.96	-109.22	-107.95	-108.51	-109.53
+4.0	-111.34	-111.32	-109.32	-109.00	-110.74	-110.91	-111.31	-105.95	-111.21
+4.5	-112.40	-106.32	-112.16	-109.68	-110.88	-112.20	-108.11	-112.45	-108.61
+5.0	-111.11	-113.93	-110.79	-107.47	-110.03	-109.29	-112.63	-111.30	-111.60

Note 5: Step size 125 kHz

Note 6: All spurs are referenced to carrier signal (n=0).



IF/RF MICROWAVE COMPONENTS • ISO 9001 ISO 14001 AS9100 CERTIFIED RoHS compliant
 P.O. Box 350166, Brooklyn, New York 11235-0003 (718) 934-4500 Fax (718) 332-4661



The Design Engineers Search Engine finds the model you need, Instantly • For detailed performance specs & shopping online see



Notes: 1. Performance and quality attributes and conditions not expressly stated in this specification sheet are intended to be excluded and do not form a part of this specification sheet. 2. Electrical specifications and performance data contained herein are based on Mini-Circuit's applicable established test performance criteria and measurement instructions. 3. The parts covered by this specification sheet are subject to Mini-Circuits standard limited warranty and terms and conditions (collectively, "Standard Terms"); Purchasers of this part are entitled to the rights and benefits contained therein. For a full statement of the Standard Terms and the exclusive rights and remedies thereunder, please visit Mini-Circuits' website at www.minicircuits.com/MCLStore/terms.jsp.

Typical Performance Curves

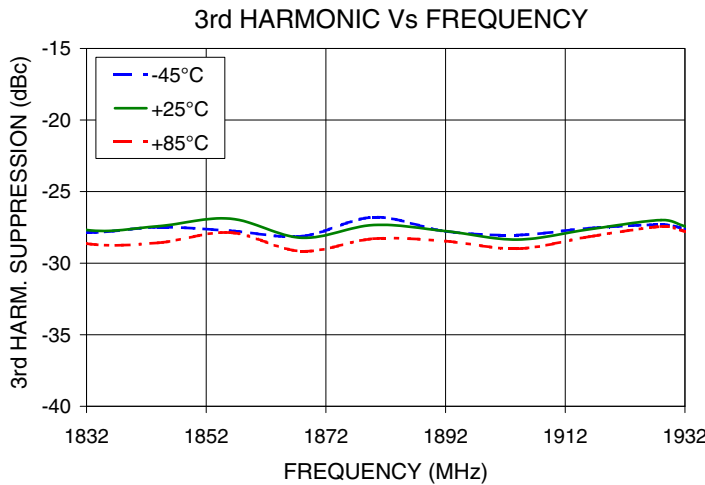
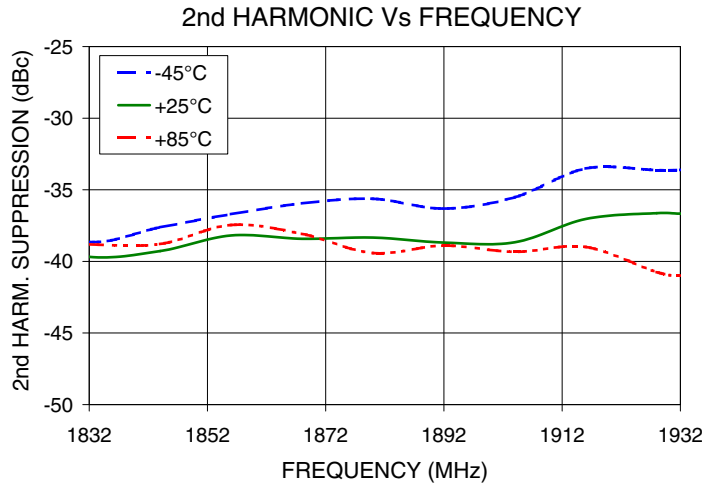
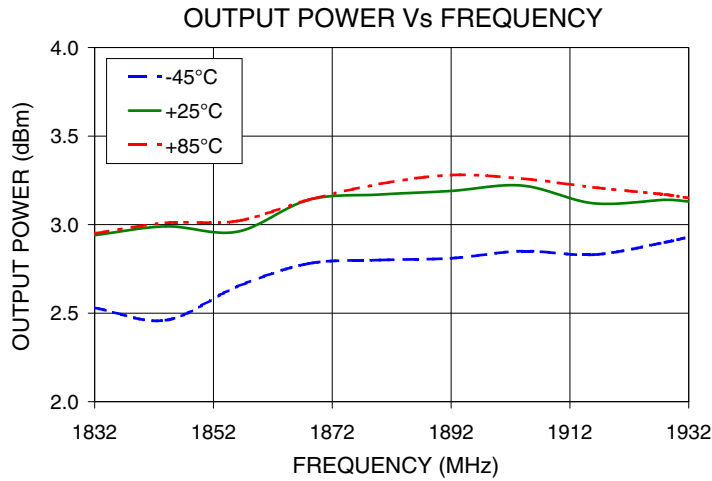

IF/RF MICROWAVE COMPONENTS • ISO 9001 ISO 14001 AS9100 CERTIFIED RoHS compliant
 P.O. Box 350166, Brooklyn, New York 11235-0003 (718) 934-4500 Fax (718) 332-4661



The Design Engineers Search Engine finds the model you need, Instantly • For detailed performance specs & shopping online see



Notes: 1. Performance and quality attributes and conditions not expressly stated in this specification sheet are intended to be excluded and do not form a part of this specification sheet. 2. Electrical specifications and performance data contained herein are based on Mini-Circuit's applicable established test performance criteria and measurement instructions. 3. The parts covered by this specification sheet are subject to Mini-Circuits standard limited warranty and terms and conditions (collectively, "Standard Terms"); Purchasers of this part are entitled to the rights and benefits contained therein. For a full statement of the Standard Terms and the exclusive rights and remedies thereunder, please visit Mini-Circuits' website at www.minicircuits.com/MCLStore/terms.jsp.

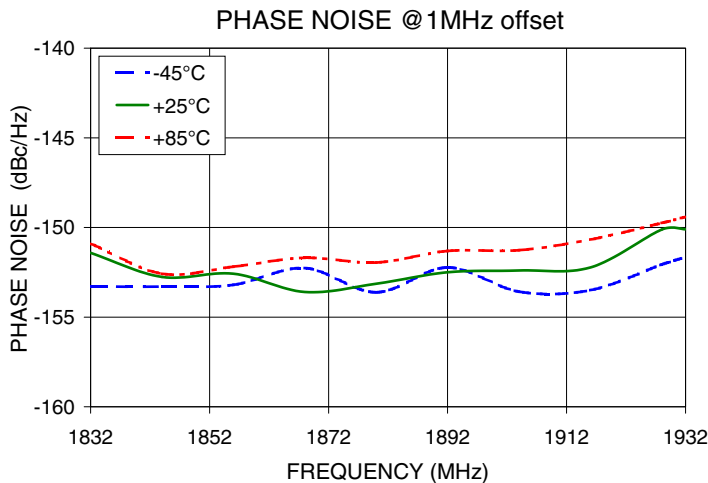
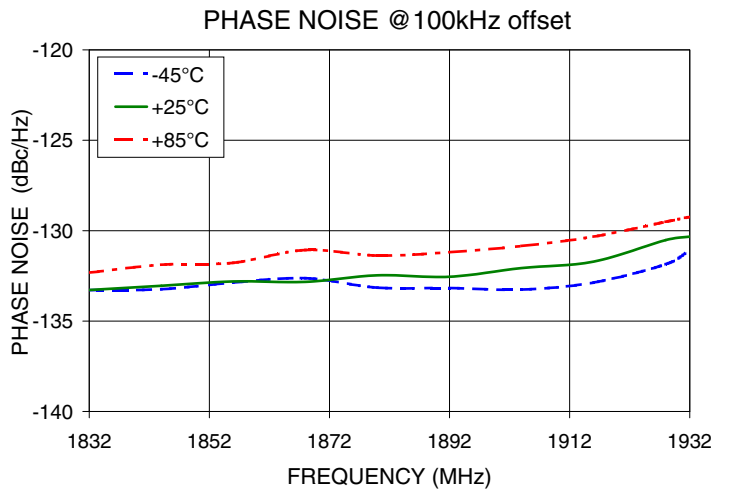
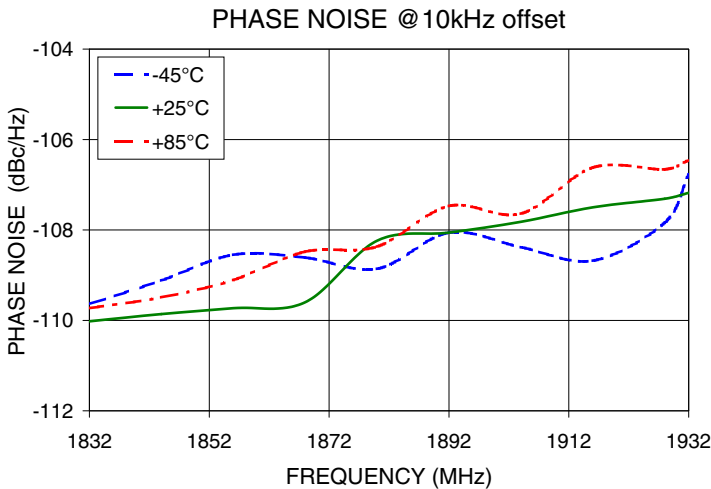
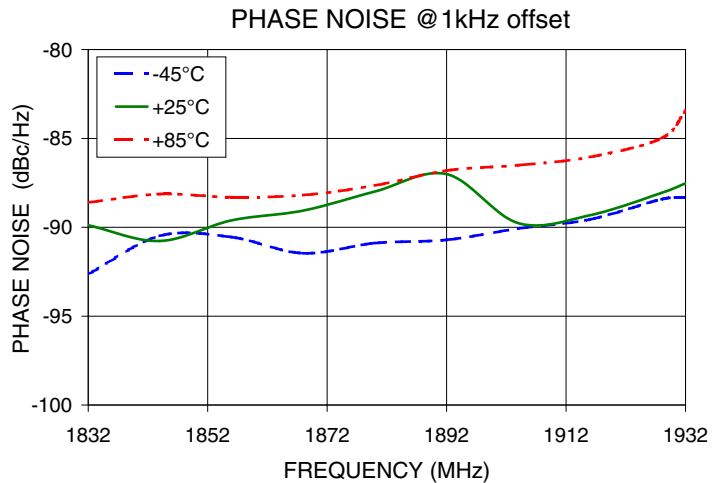
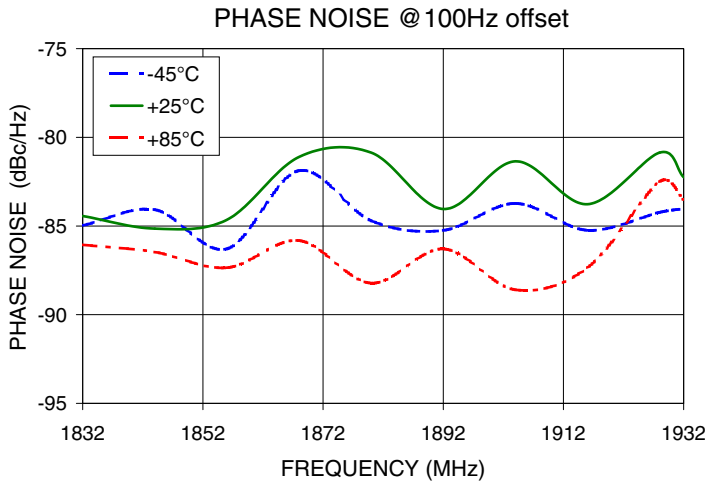

IF/RF MICROWAVE COMPONENTS • ISO 9001 ISO 14001 AS9100 CERTIFIED RoHS compliant
 P.O. Box 350166, Brooklyn, New York 11235-0003 (718) 934-4500 Fax (718) 332-4661



The Design Engineers Search Engine finds the model you need, Instantly • For detailed performance specs & shopping online see



Notes: 1. Performance and quality attributes and conditions not expressly stated in this specification sheet are intended to be excluded and do not form a part of this specification sheet. 2. Electrical specifications and performance data contained herein are based on Mini-Circuit's applicable established test performance criteria and measurement instructions. 3. The parts covered by this specification sheet are subject to Mini-Circuits standard limited warranty and terms and conditions (collectively, "Standard Terms"); Purchasers of this part are entitled to the rights and benefits contained therein. For a full statement of the Standard Terms and the exclusive rights and remedies thereunder, please visit Mini-Circuits' website at www.minicircuits.com/MCLStore/terms.jsp.

COMPARISON SPURIOUS
Vs FREQ. OFFSET @ Fcar = 1832MHz

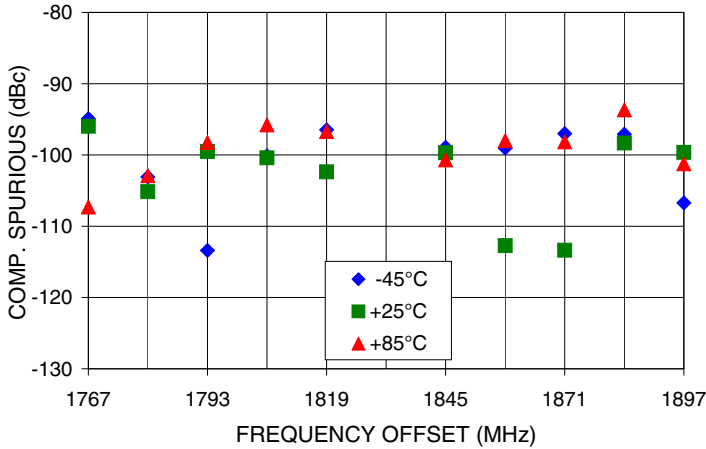

REFERENCE SPURIOUS
Vs FREQ. OFFSET @ Fcar = 1832MHz

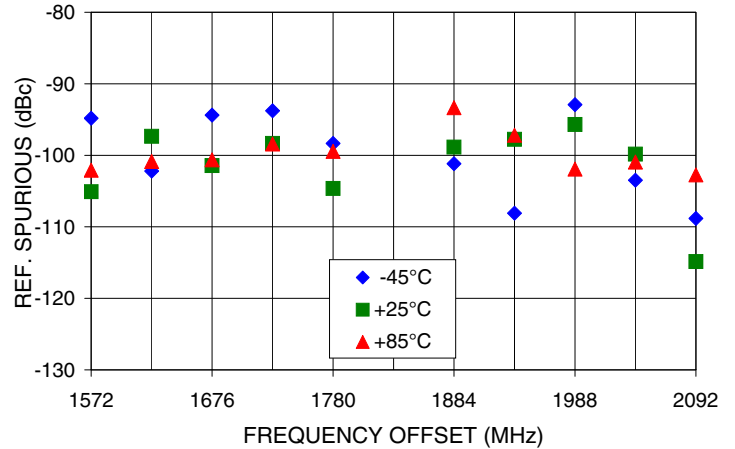

COMPARISON SPURIOUS
Vs FREQ. OFFSET @ Fcar = 1882MHz

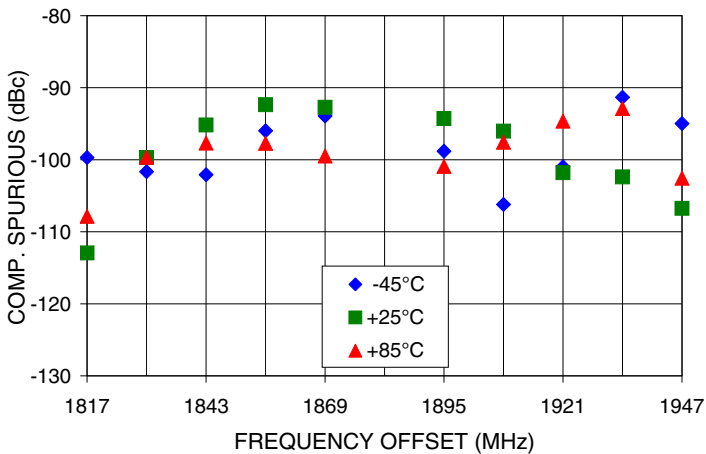

REFERENCE SPURIOUS
Vs FREQ. OFFSET @ Fcar = 1882MHz

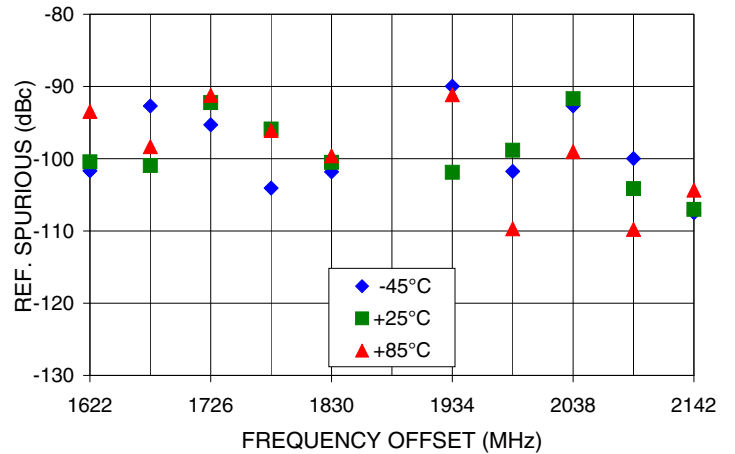

COMPARISON SPURIOUS
Vs FREQ. OFFSET @ Fcar = 1932MHz

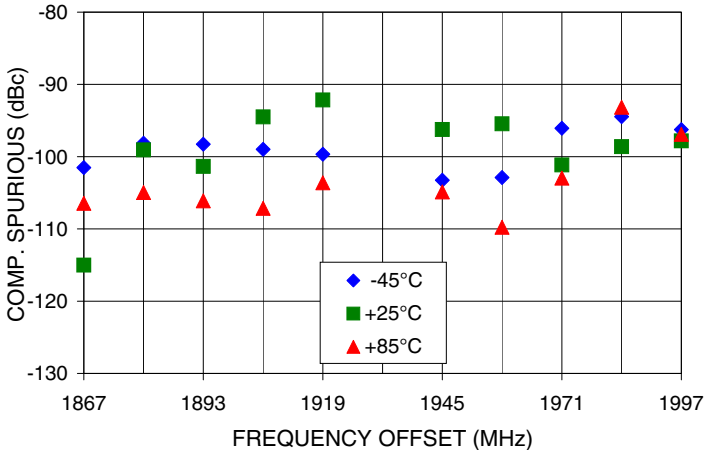

REFERENCE SPURIOUS
Vs FREQ. OFFSET @ Fcar = 1932MHz

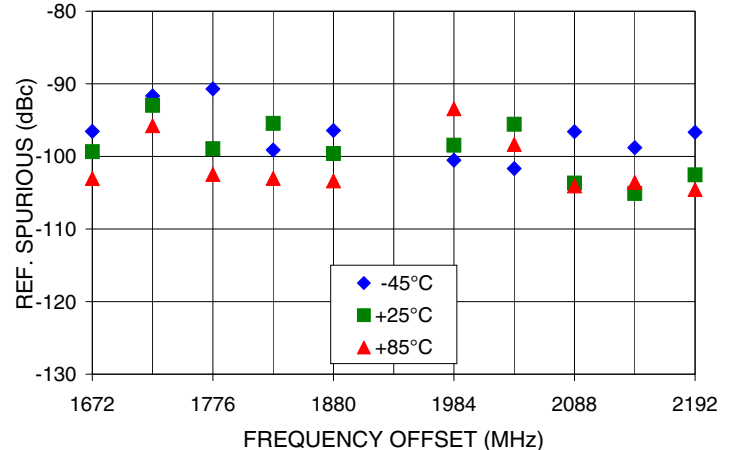

IF/RF MICROWAVE COMPONENTS • ISO 9001 ISO 14001 AS9100 CERTIFIED RoHS compliant
P.O. Box 350166, Brooklyn, New York 11235-0003 (718) 934-4500 Fax (718) 332-4661



The Design Engineers Search Engine finds the model you need, Instantly • For detailed performance specs & shopping online see



Notes: 1. Performance and quality attributes and conditions not expressly stated in this specification sheet are intended to be excluded and do not form a part of this specification sheet. 2. Electrical specifications and performance data contained herein are based on Mini-Circuit's applicable established test performance criteria and measurement instructions. 3. The parts covered by this specification sheet are subject to Mini-Circuits standard limited warranty and terms and conditions (collectively, "Standard Terms"); Purchasers of this part are entitled to the rights and benefits contained therein. For a full statement of the Standard Terms and the exclusive rights and remedies thereunder, please visit Mini-Circuits' website at www.minicircuits.com/MCLStore/terms.jsp.

0.5 STEP SIZE & STEP SIZE SPURIOUS
Vs FREQ. OFFSET @ Fcar = 1832MHz

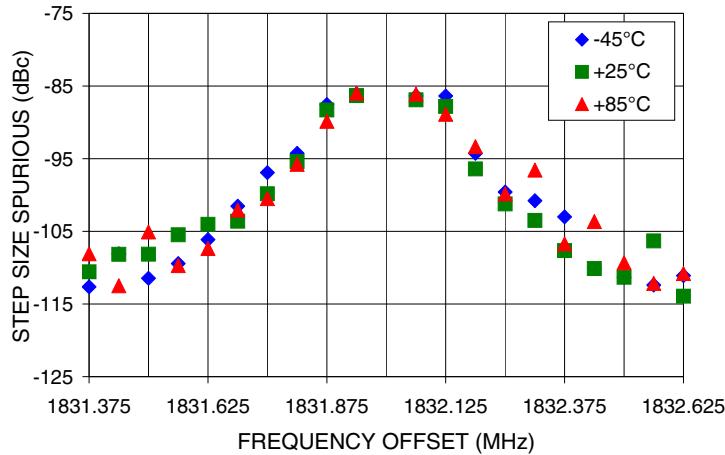

0.5 STEP SIZE & STEP SIZE SPURIOUS
Vs FREQ. OFFSET @ Fcar = 1882MHz

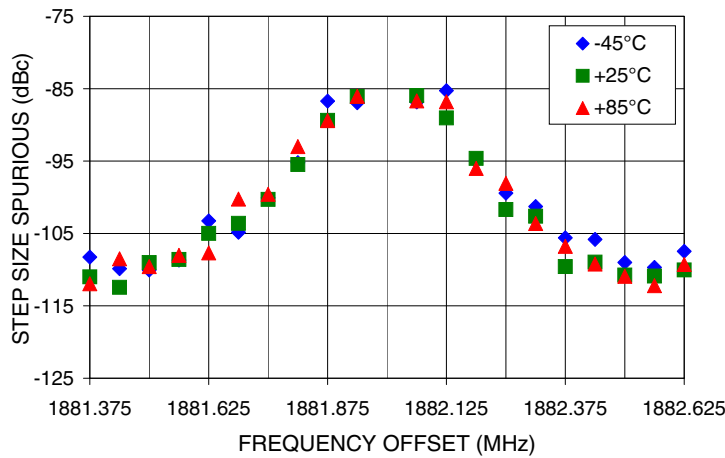

0.5 STEP SIZE & STEP SIZE SPURIOUS
Vs FREQ. OFFSET @ Fcar = 1932MHz

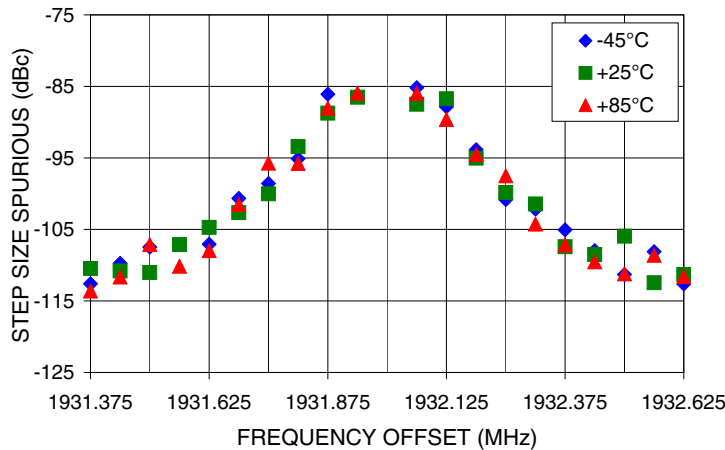

IF/RF MICROWAVE COMPONENTS • ISO 9001 ISO 14001 AS9100 CERTIFIED RoHS compliant
P.O. Box 350166, Brooklyn, New York 11235-0003 (718) 934-4500 Fax (718) 332-4661



The Design Engineers Search Engine finds the model you need, Instantly • For detailed performance specs & shopping online see



Notes: 1. Performance and quality attributes and conditions not expressly stated in this specification sheet are intended to be excluded and do not form a part of this specification sheet. 2. Electrical specifications and performance data contained herein are based on Mini-Circuit's applicable established test performance criteria and measurement instructions. 3. The parts covered by this specification sheet are subject to Mini-Circuits standard limited warranty and terms and conditions (collectively, "Standard Terms"); Purchasers of this part are entitled to the rights and benefits contained therein. For a full statement of the Standard Terms and the exclusive rights and remedies thereunder, please visit Mini-Circuits' website at www.minicircuits.com/MCLStore/terms.jsp.

Pin Configuration

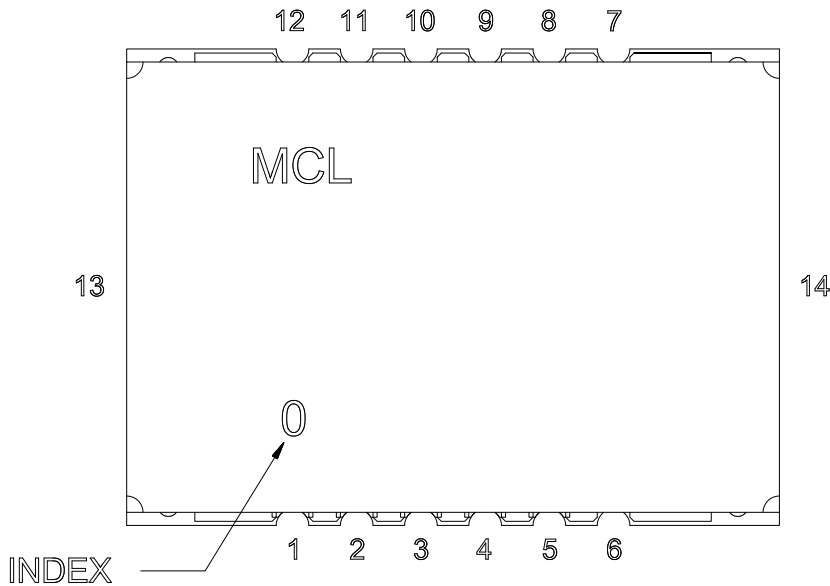

Pin Connection

Pin Number	Function
1	VCC PLL
2	GND
3	REF IN
4	GND
5	VCC VCO
6	GND
7	RF OUT
8	GND
9	LOCK DET
10	CLOCK
11	DATA
12	LE
13	GND
14	GND

Recommended Application Circuit

Note: REF IN and RF OUT ports are internally AC coupled.

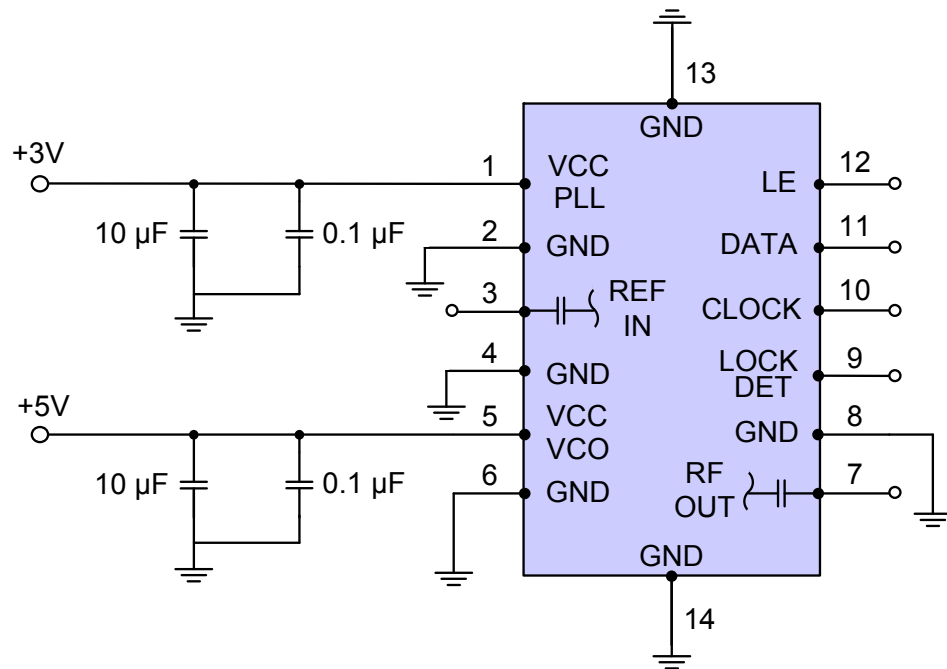

IF/RF MICROWAVE COMPONENTS • ISO 9001 ISO 14001 AS9100 CERTIFIED RoHS compliant
 P.O. Box 350166, Brooklyn, New York 11235-0003 (718) 934-4500 Fax (718) 332-4661



The Design Engineers Search Engine finds the model you need, Instantly • For detailed performance specs & shopping online see



Notes: 1. Performance and quality attributes and conditions not expressly stated in this specification sheet are intended to be excluded and do not form a part of this specification sheet. 2. Electrical specifications and performance data contained herein are based on Mini-Circuit's applicable established test performance criteria and measurement instructions. 3. The parts covered by this specification sheet are subject to Mini-Circuits standard limited warranty and terms and conditions (collectively, "Standard Terms"); Purchasers of this part are entitled to the rights and benefits contained therein. For a full statement of the Standard Terms and the exclusive rights and remedies thereunder, please visit Mini-Circuits' website at www.minicircuits.com/MCLStore/terms.jsp.

Device Marking

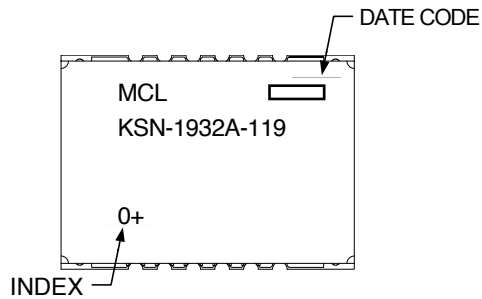

Additional Detailed Technical Information

Additional information is available on our web site. To access this information enter the model number on our web site home page.

Case Style: DK1182

Tape & Reel: TR-F28

Suggested Layout for PCB Design: PL-249

Evaluation Board: TB-567-2+

Environment Ratings: ENV03T2



IF/RF MICROWAVE COMPONENTS • ISO 9001 ISO 14001 AS9100 CERTIFIED RoHS compliant
P.O. Box 350166, Brooklyn, New York 11235-0003 (718) 934-4500 Fax (718) 332-4661



The Design Engineers Search Engine finds the model you need, Instantly • For detailed performance specs & shopping online see



Notes: 1. Performance and quality attributes and conditions not expressly stated in this specification sheet are intended to be excluded and do not form a part of this specification sheet. 2. Electrical specifications and performance data contained herein are based on Mini-Circuit's applicable established test performance criteria and measurement instructions. 3. The parts covered by this specification sheet are subject to Mini-Circuits standard limited warranty and terms and conditions (collectively, "Standard Terms"); Purchasers of this part are entitled to the rights and benefits contained therein. For a full statement of the Standard Terms and the exclusive rights and remedies thereunder, please visit Mini-Circuits' website at www.minicircuits.com/MCLStore/terms.jsp.

Данный компонент на территории Российской Федерации

Вы можете приобрести в компании MosChip.

Для оперативного оформления запроса Вам необходимо перейти по данной ссылке:

<http://moschip.ru/get-element>

Вы можете разместить у нас заказ для любого Вашего проекта, будь то серийное производство или разработка единичного прибора.

В нашем ассортименте представлены ведущие мировые производители активных и пассивных электронных компонентов.

Нашей специализацией является поставка электронной компонентной базы двойного назначения, продукции таких производителей как XILINX, Intel (ex.ALTERA), Vicor, Microchip, Texas Instruments, Analog Devices, Mini-Circuits, Amphenol, Glenair.

Сотрудничество с глобальными дистрибьюторами электронных компонентов, предоставляет возможность заказывать и получать с международных складов практически любой перечень компонентов в оптимальные для Вас сроки.

На всех этапах разработки и производства наши партнеры могут получить квалифицированную поддержку опытных инженеров.

Система менеджмента качества компании отвечает требованиям в соответствии с ГОСТ Р ИСО 9001, ГОСТ РВ 0015-002 и ЭС РД 009

Офис по работе с юридическими лицами:

105318, г.Москва, ул.Щербаковская д.3, офис 1107, 1118, ДЦ «Щербаковский»

Телефон: +7 495 668-12-70 (многоканальный)

Факс: +7 495 668-12-70 (доб.304)

E-mail: info@moschip.ru

Skype отдела продаж:

moschip.ru

moschip.ru_4

moschip.ru_6

moschip.ru_9