

Analog Devices Welcomes Hittite Microwave Corporation

NO CONTENT ON THE ATTACHED DOCUMENT HAS CHANGED



THIS PAGE INTENTIONALLY LEFT BLANK



GaAs MMIC SUB HARMONIC MIXER, 71 - 86 GHz

Typical Applications

The HMC1058 is ideal for:

- E-Band Communications Systems
- Test Equipment & Sensors
- Military End-Use
- Automotive Radar

Features

- Passive: No DC Bias Required
- Low LO Power: 9 dBm
- High LO/RF Isolation: 28 dB
- High 2LO/RF Isolation: 43 dB
- Wide IF Bandwidth: DC to 12 GHz
- Upconversion & Downconversion Applications
- Die Size: 1.15 x 0.97 x 0.1 mm

Functional Diagram

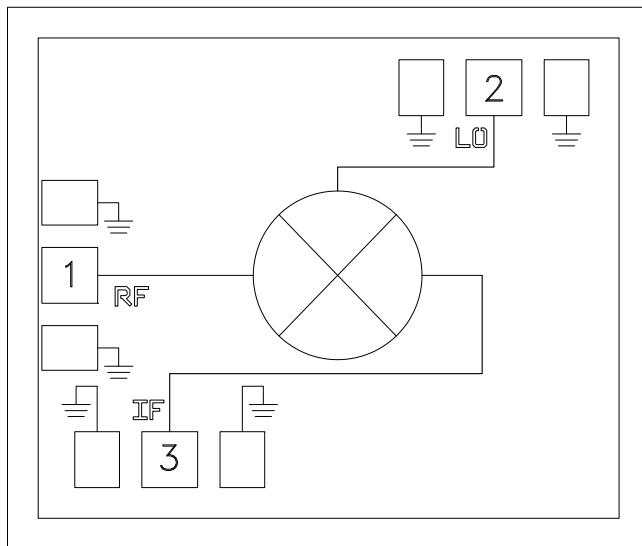

General Description

The HMC1058 is a sub-harmonically pumped MMIC mixer. It can be used as an upconverter or a downconverter, with DC to 12 GHz at the IF port and 71 to 86 GHz at the RF port. This passive MMIC mixer is fabricated with GaAs Schottky diode technology. All bond pads and the die backside are Ti/Au metallized and the Schottky devices are fully passivated for reliable operation. All data shown herein is measured with the chip in a 50 Ohm environment and contacted with RF probes.

Electrical Specifications, $T_A = +25^\circ C$, $IF = 4 GHz$, $LO = +9 dBm$, USB ^[1]

Parameter	Min.	Typ.	Max.	Units
RF Frequency Range		71 - 86		GHz
IF Frequency Range		DC - 12		GHz
LO Frequency Range		29 - 43		GHz
Conversion Loss	-14	-11		dB
2LO to RF Isolation		43		dB
LO to RF Isolation		28		dB
LO to IF Isolation		20		dB
RF to IF Isolation		18		dB
IP3 (Input) ^[2]		6		dBm

[1] Unless otherwise noted, all measurements performed as a downconverter with LO = +9 dBm.

[2] Upconverter performance.



**GaAs MMIC SUB HARMONIC
MIXER, 71 - 86 GHz**

**Conversion Gain vs. Temperature
IF= 2 GHz, USB**

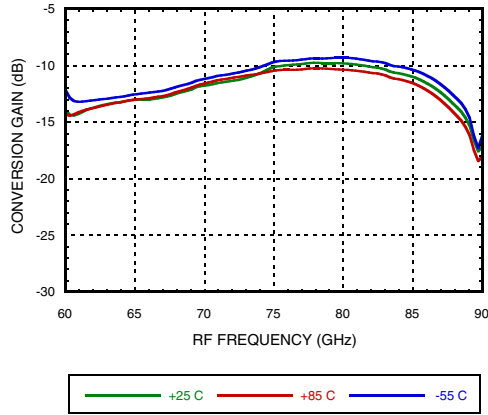

**Conversion Gain vs. Temperature
IF= 4 GHz, USB**

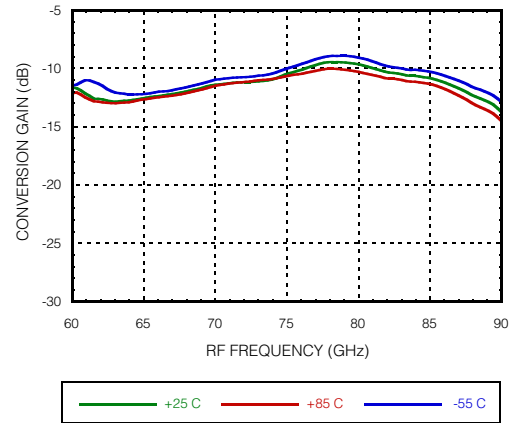

**Conversion Gain vs. Temperature
IF= 8 GHz, USB**

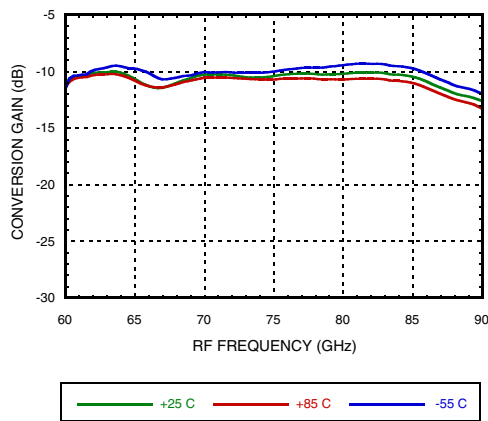

**Conversion Gain vs. Temperature
IF= 12 GHz, USB**

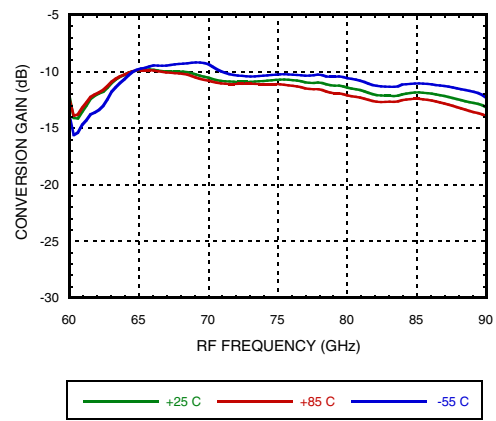

**Conversion Gain vs. LO Power
IF= 2 GHz, USB**

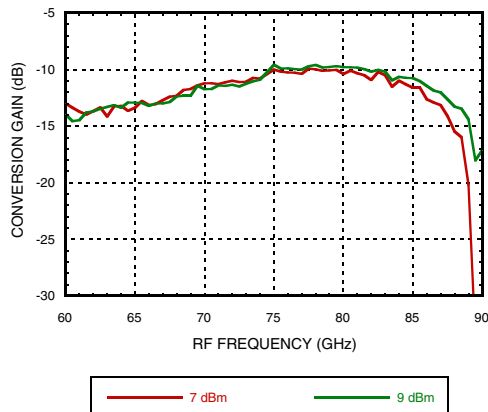

**Conversion Gain vs. LO Power
IF= 4 GHz, USB**

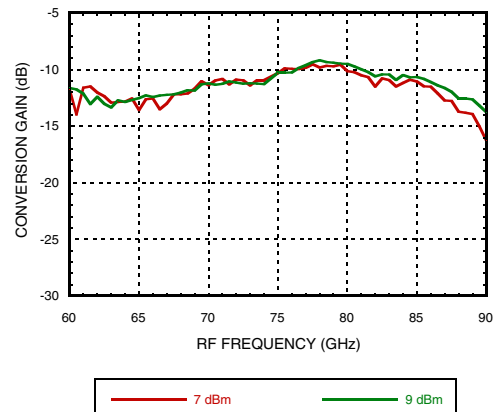

GaAs MMIC SUB HARMONIC MIXER, 71 - 86 GHz



MIXERS - SUB HARMONIC - CHIP

Conversion Gain vs. Lo Power
IF= 8 GHz, USB

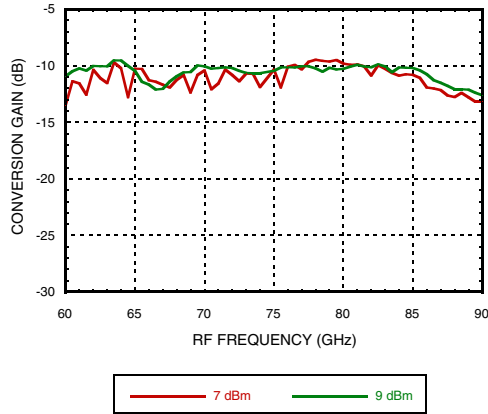

Conversion Gain vs. LO Power
IF= 12 GHz, USB

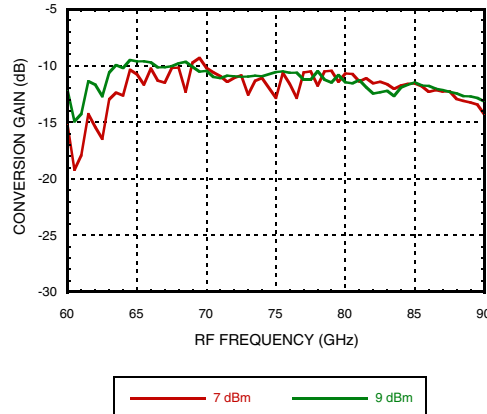

Conversion Gain vs. LO Power
IF= 2 GHz, LSB

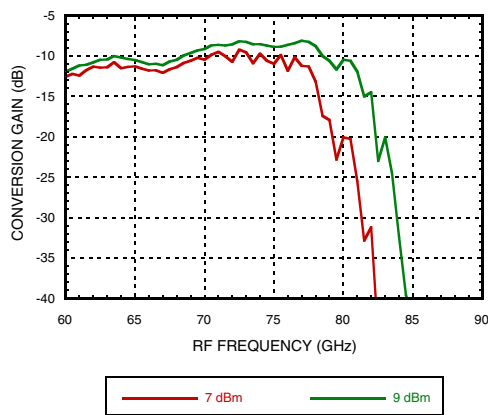

Conversion Gain vs. LO Power
IF= 4 GHz, LSB

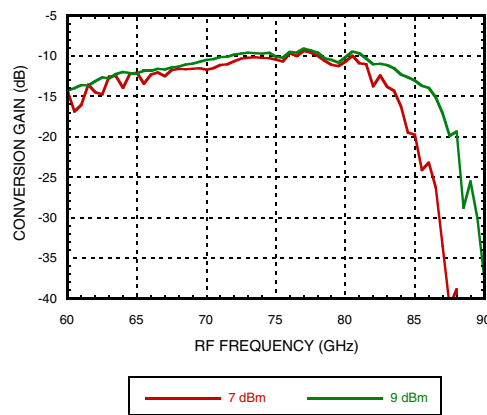

Conversion Gain vs. LO Power
IF= 8 GHz, LSB

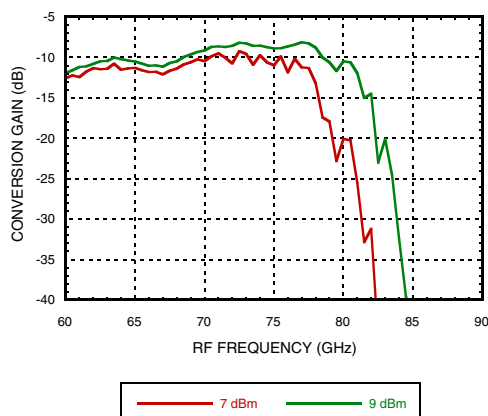

Conversion Gain vs. LO Power
IF= 12 GHz, LSB

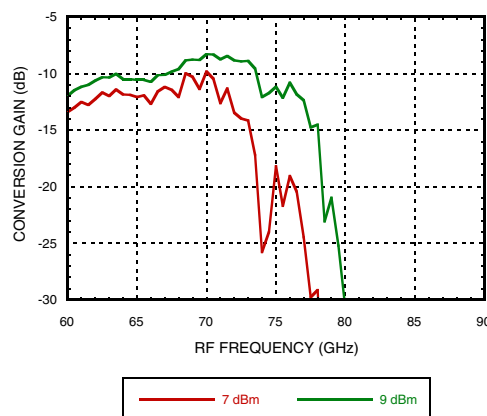



**GaAs MMIC SUB HARMONIC
MIXER, 71 - 86 GHz**

**Conversion Gain IFBW vs. LO Power
LO=31.25 GHz, USB**

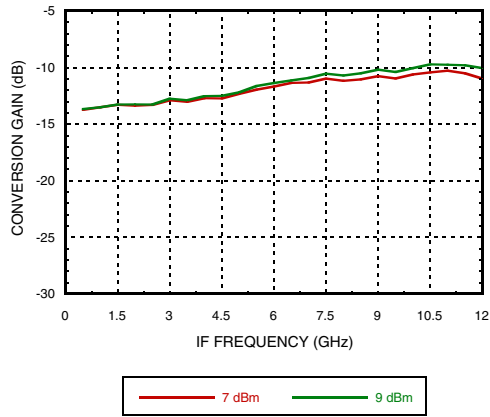

**Conversion Gain IFBW vs. LO Power
Downconverter, LO=37.25 GHz, USB**

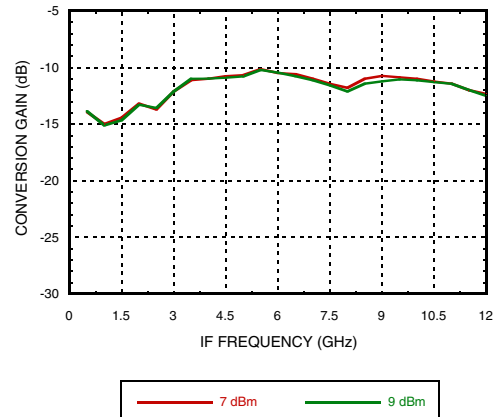

**Conversion Gain, Upconverter,
LO=9dBm, IF= 4 GHz, USB**

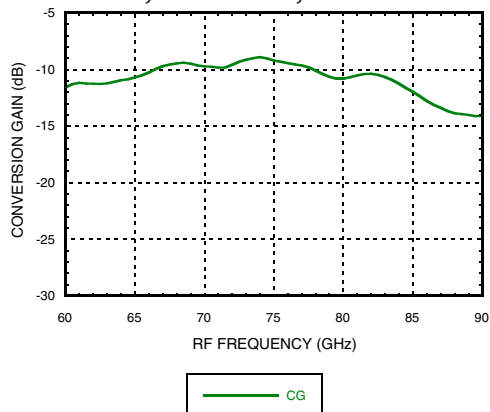

**Conversion Gain, Upconverter,
LO=9dBm, IF= 4 GHz, LSB**

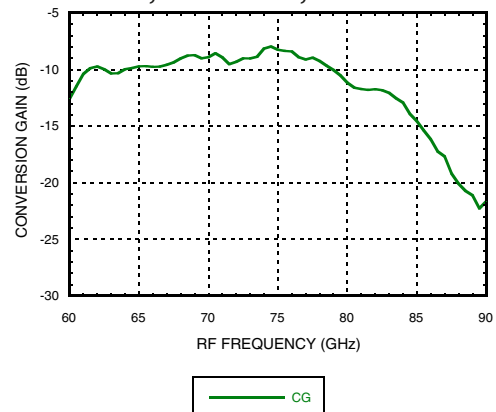

**Input IP3, Upconverter, LO= 9dBm,
IF=4 GHz, USB**

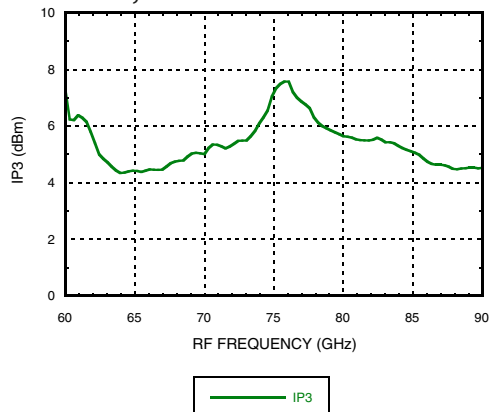

**Input IP3, Upconverter, LO= 9dBm,
IF=4 GHz, LSB**

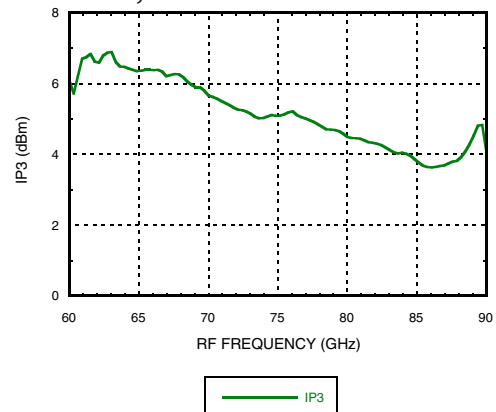

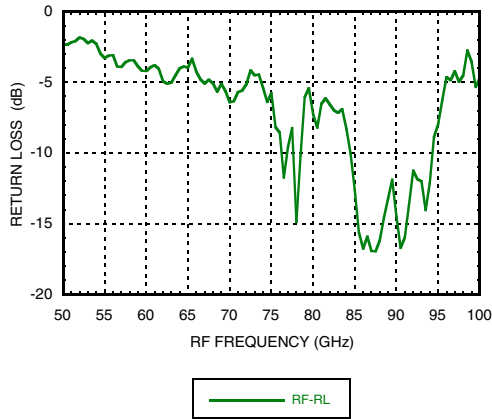
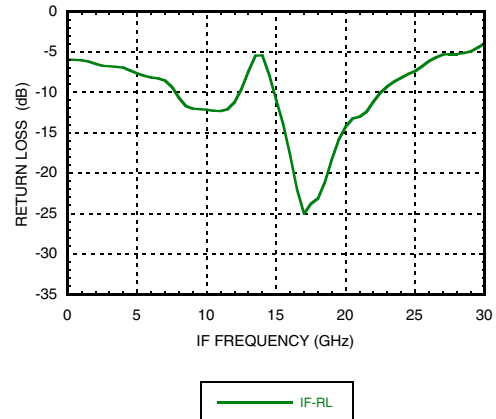
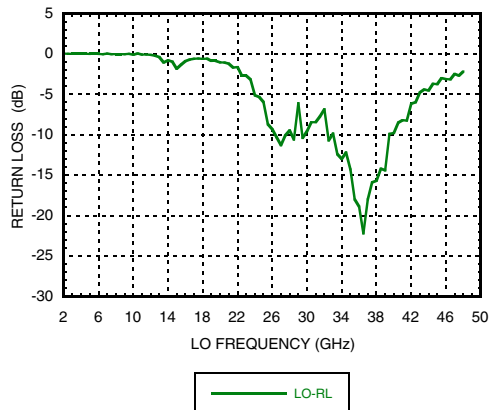
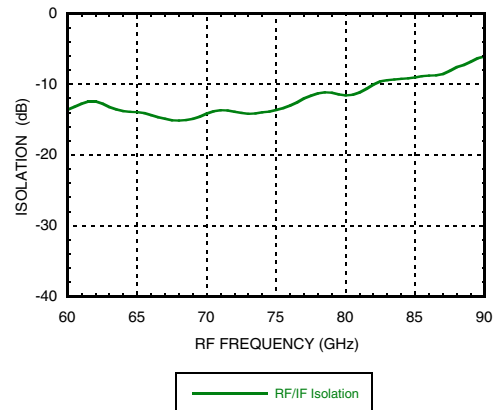
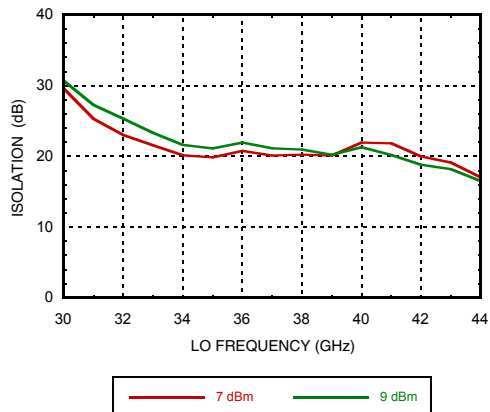
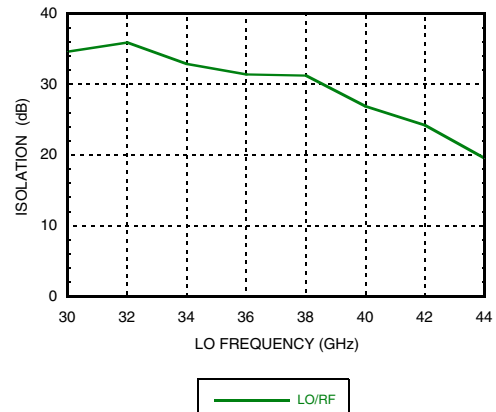

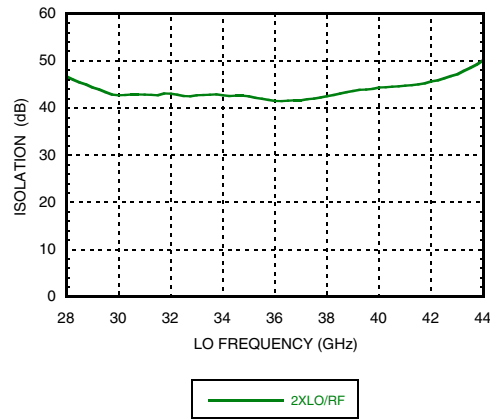
**GaAs MMIC SUB HARMONIC
MIXER, 71 - 86 GHz**
MIXERS - SUB HARMONIC - CHIP
RF Return Loss

IF Return Loss

LO Return Loss

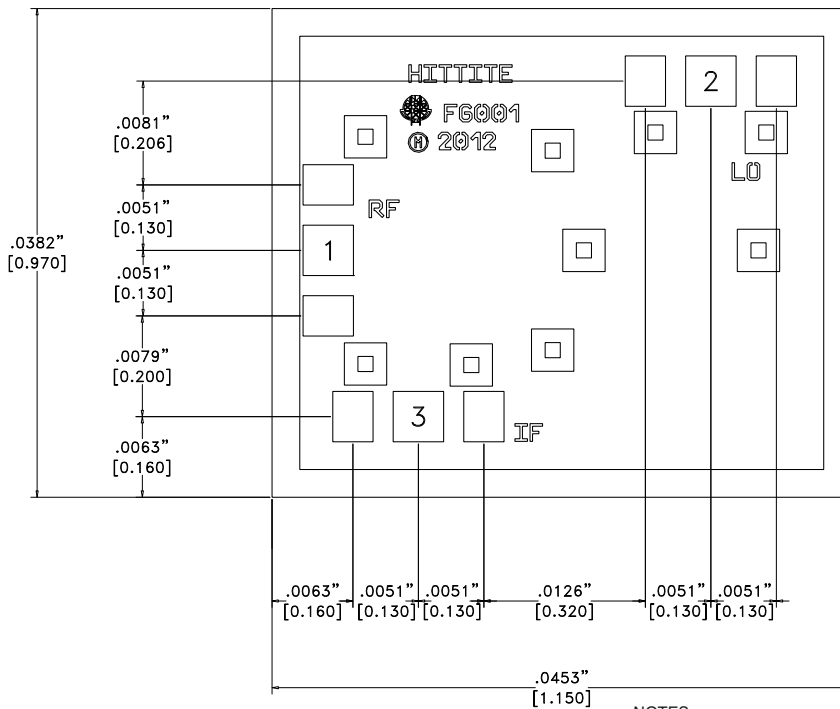
RF/IF Isolation

LO/IF Isolation vs. LO Drive

LO/RF isolation

**GaAs MMIC SUB HARMONIC
MIXER, 71 - 86 GHz****2LO/RF Isolation**

**GaAs MMIC SUB HARMONIC
MIXER, 71 - 86 GHz**
Table 1. Absolute Maximum Ratings

RF Input (LO = +9 dBm)	+5 dBm
LO Drive	+20 dBm
IF Input	+3 dBm
Maximum Junction Temperature	170 °C
Thermal Resistance (R _{TH}) (junction to die bottom)	555 °C/W
Operating Temperature	-55 to +85 °C
Storage Temperature	-65 to 150 °C

**ELECTROSTATIC SENSITIVE DEVICE
OBSERVE HANDLING PRECAUTIONS**
Outline Drawing

NOTES:

1. ALL DIMENSIONS ARE IN INCHES [MM].
2. DIE THICKNESS IS 0.004"
3. BOND PADS 1, 2 & 3 are 0.0059" [0.150] X 0.0039" [0.099].
4. BACKSIDE METALLIZATION: GOLD.
5. BOND PAD METALLIZATION: GOLD.
6. BACKSIDE METAL IS GROUND.
7. CONNECTION NOT REQUIRED FOR UNLABELED BOND PADS.
8. OVERALL DIE SIZE ± 0.002

Table 2. Die Packaging Information ^[1]

Standard	Alternate
GP-2 (Gel Pack)	[2]

[1] For more information refer to the "Packaging information" Document in the Product Support Section of our website.

[2] For alternate packaging information contact Hittite Microwave Corporation.

Table 3. Pad Descriptions

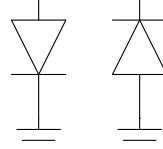
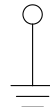
Pad Number	Function	Description	Pad Schematic
1	RF	This pad is matched to 50 Ohms.	RF ○ ———
2	LO	This pad is AC coupled and Matched to 50 Ohms.	LO ○ ——— ———
3	IF	This pad is AC coupled and Matched to 50 Ohms.	IF ○ ——— 
Die Bottom	GND	Die bottom must be connected to RF/DC ground	○ GND 

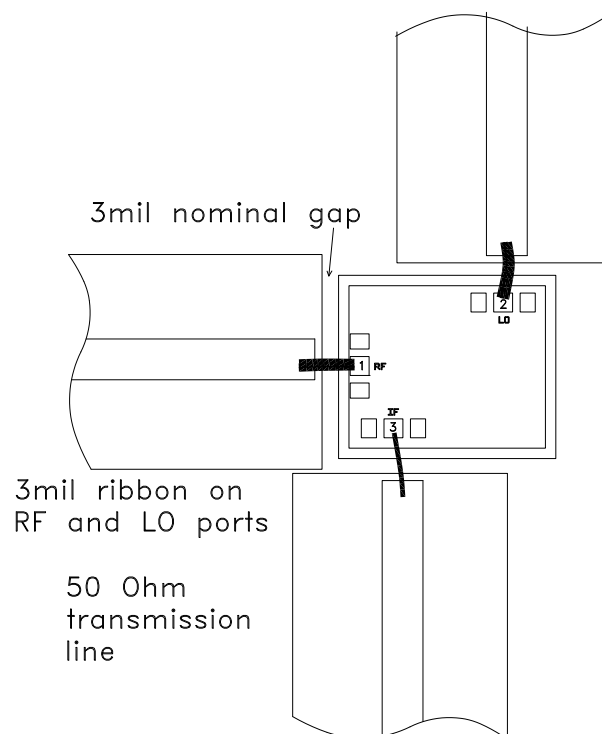
Assembly Diagram



GaAs MMIC SUB HARMONIC MIXER, 71 - 86 GHz

Mounting & Bonding Techniques for Millimeterwave GaAs MMICs

The die should be attached directly to the ground plane eutectically or with conductive epoxy (see HMC general Handling, Mounting, Bonding Note).

50 Ohm Microstrip transmission lines on 0.127mm (5 mil) thick alumina thin film substrates are recommended for bringing RF to and from the chip (Figure 1). One way to accomplish this is to attach the 0.102mm (4 mil) thick die to a 0.150mm (6 mil) thick molybdenum heat spreader (moly-tab) which is then attached to the ground plane (Figure 2). Microstrip substrates should be located as close to the die as possible in order to minimize bond wire length. Typical die-to-substrate spacing is 0.076mm to 0.152 mm (3 to 6 mils).

Handling Precautions

Follow these precautions to avoid permanent damage.

Storage: All bare die are placed in either Waffle or Gel based ESD protective containers, and then sealed in an ESD protective bag for shipment. Once the sealed ESD protective bag has been opened, all die should be stored in a dry nitrogen environment.

Cleanliness: Handle the chips in a clean environment. DO NOT attempt to clean the chip using liquid cleaning systems.

Static Sensitivity: Follow ESD precautions to protect against $> \pm 250V$ ESD strikes.

Transients: Suppress instrument and bias supply transients while bias is applied. Use shielded signal and bias cables to minimize inductive pick-up.

General Handling: Handle the chip along the edges with a vacuum collet or with a sharp pair of bent tweezers. The surface of the chip may have fragile air bridges and should not be touched with vacuum collet, tweezers, or fingers.

Mounting

The chip is back-metallized and can be die mounted with AuSn eutectic preforms or with electrically conductive epoxy. The mounting surface should be clean and flat.

Eutectic Die Attach: A 80/20 gold tin preform is recommended with a work surface temperature of 255 °C and a tool temperature of 265 °C. When hot 90/10 nitrogen/hydrogen gas is applied, tool tip temperature should be 290 °C. DO NOT expose the chip to a temperature greater than 320 °C for more than 20 seconds. No more than 3 seconds of scrubbing should be required for attachment.

Epoxy Die Attach: Apply a minimum amount of epoxy to the mounting surface so that a thin epoxy fillet is observed around the perimeter of the chip once it is placed into position. Cure epoxy per the manufacturer's schedule.

Wire Bonding

Ball or wedge bond with 0.025mm (1 mil) diameter pure gold wire. Thermosonic wirebonding with a nominal stage temperature of 150 °C and a ball bonding force of 40 to 50 grams or wedge bonding force of 18 to 22 grams is recommended. Use the minimum level of ultrasonic energy to achieve reliable wirebonds. Wirebonds should be started on the chip and terminated on the package or substrate. All bonds should be as short as possible $< 0.31mm$ (12 mils).

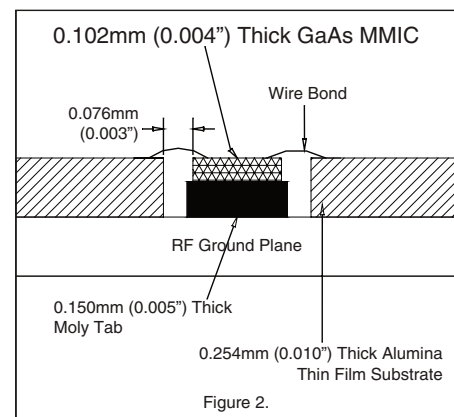
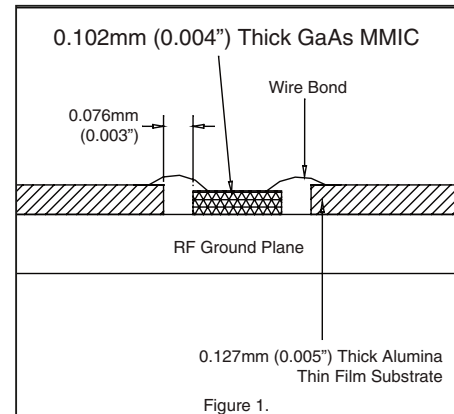



MICROWAVE CORPORATION v01.0413



Notes:

HMC1058

**GaAs MMIC SUB HARMONIC
MIXER, 71 - 86 GHz**

Данный компонент на территории Российской Федерации

Вы можете приобрести в компании MosChip.

Для оперативного оформления запроса Вам необходимо перейти по данной ссылке:

<http://moschip.ru/get-element>

Вы можете разместить у нас заказ для любого Вашего проекта, будь то серийное производство или разработка единичного прибора.

В нашем ассортименте представлены ведущие мировые производители активных и пассивных электронных компонентов.

Нашей специализацией является поставка электронной компонентной базы двойного назначения, продукции таких производителей как XILINX, Intel (ex.ALTERA), Vicor, Microchip, Texas Instruments, Analog Devices, Mini-Circuits, Amphenol, Glenair.

Сотрудничество с глобальными дистрибьюторами электронных компонентов, предоставляет возможность заказывать и получать с международных складов практически любой перечень компонентов в оптимальные для Вас сроки.

На всех этапах разработки и производства наши партнеры могут получить квалифицированную поддержку опытных инженеров.

Система менеджмента качества компании отвечает требованиям в соответствии с ГОСТ Р ИСО 9001, ГОСТ РВ 0015-002 и ЭС РД 009

Офис по работе с юридическими лицами:

105318, г.Москва, ул.Щербаковская д.3, офис 1107, 1118, ДЦ «Щербаковский»

Телефон: +7 495 668-12-70 (многоканальный)

Факс: +7 495 668-12-70 (доб.304)

E-mail: info@moschip.ru

Skype отдела продаж:

moschip.ru

moschip.ru_4

moschip.ru_6

moschip.ru_9