

Description

The AGF600-24S28 is a single output DC-DC converter with standard full-brick outline and pin configuration. It delivers up to 21.5A output current with 28V output voltage. Above 93.5% ultra-high efficiency and excellent thermal performance make it an ideal choice to supply power to power amplifier in telecom RF application. Thanks to the aluminium baseplate it can work under -40°C ~ +85°C without air cooling.

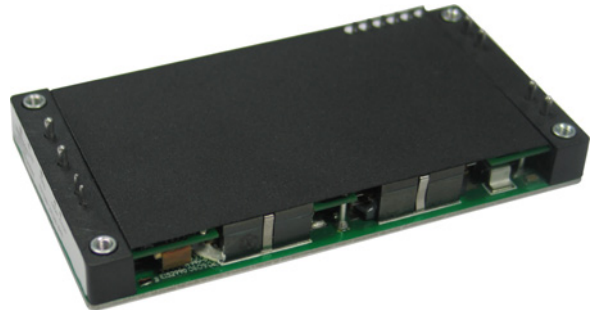

Operational Features

- Delivering up to 21.5A output current
- Ultra-high efficiency 93.5% typ. at half load
- Excellent thermal performance
- Wide input range: 18V ~ 36V
- No minimum load requirement
- Fixed frequency operation
- RoHS 6 compliant

Control Features

- Remote control function
- Remote output sense
- Trim function: -50% ~ +18%

Protection Features

- Input under voltage protection
- Output over current protection
- Output over voltage protection
- Over temperature protection

Mechanical Features

- Industry standard full-brick pin-out outline
- With aluminium baseplate
- Pin length: 3.8mm

Safety & EMC

- Meets safety standards UL 60950-1, IEC/EN 60950-1 and GB4943
- Approved by UL and TUV
- Meets 2006/95/EEC and 93/68/EEC directives which facilitates CE marking in user's end product
- Meets conducted emission's requirements of EN55022 Class A with external filter

Electrical Characteristics

Full operating ambient temperature range is -40°C to +85°C.

Specifications are subject to change without notice.

Parameter		Min.	Typ.	Max.	Unit	Notes & Conditions
Absolute max. ratings						
Input voltage	Non-operating			50	V	100ms
	Operating			36	V	Continuous
Operating temperature		-40		85	°C	
Storage temperature		-55		125	°C	
Input characteristics						
Operating input voltage range		18	24	36	V	
Input under-voltage lockout	Turn-on voltage threshold	15		18	V	
	Turn-off voltage threshold	14		17	V	
	Lockout voltage hysteresis	1		3	V	
Max. input current				40	A	18V _{in} , full load
No-load input current			0.5	0.7	A	24V _{in}
Standby Input current			0.05	0.1	A	Remote OFF
Inrush current transient rating			0.5	1	A ² s	Figure 18
Input reflected ripple current				320	mA	Through 12μH inductor; Figure 18
Recommended input fuse			60		A	Fast blow external fuse recommended Figure 13
Input filter component values (C/L)			4.7*13\0.35		μF\μH	Internal values
Recommended external input capacitance			1000		μF	Low ESR capacitor recommended Figure 13
Output characteristics						
Output voltage set point (standard option)		27.72	28	28.28	V	24V _{in} , full load
Output voltage line regulation			0.1	0.2	%	
			28	56	mV	
Output voltage load regulation			0.2	0.5	%	
			56	140	mV	

Parameter		Min.	Typ.	Max.	Unit	Notes & Conditions
Output voltage temperature regulation				0.02	%/°C	
Total output voltage range		27.20	28	28.80	V	Over sample, line, load, temperature & life
Output voltage ripple and noise				200	mVpp	20MHz bandwidth; Figure 18
Operating output current range		0		21.5	A	
Output DC current-limit inception		23.65		30.1	A	Hiccup, see Figure 12
Output capacitance		470	1000	10000	μF	
Dynamic characteristics						
Dynamic response	25% ~ 50% ~ 25% $I_{o,max}$, 0.1A/μs			840	mV	Figure 6 Test condition: see Figure 13
	Settling time			500	μs	Recovery to within 1% $V_{o,nom}$
	50% ~ 75% ~ 50% $I_{o,max}$, 0.1A/μs			840	mV	Figure 7 Test condition: see Figure 13
	Settling time			500	μs	Recovery to within 1% $V_{o,nom}$
Turn-on transient	Rise time	20		200	ms	Full load, Figure 8
	Turn-on delay time	0		200	ms	
	Output voltage overshoot			5	% V_o	
Efficiency						
100% load			92.0		%	Figure 1
50% load			93.5		%	Figure 1

Electrical Characteristics (Continued)

Parameter	Min.	Typ.	Max.	Unit	Notes & Conditions
Isolation characteristics					
Isolation voltage (1mA, 5s)		1500		V	Basic insulation, pollution degree 2, input to output
		1500		V	Basic insulation, pollution degree 2, input to baseplate
		500		V	Basic insulation, pollution degree 2, output to baseplate

Parameter	Min.	Typ.	Max.	Unit	Notes & Conditions
Feature characteristics					
Switching frequency	230	260	290	kHz	
Remote ON/OFF control	1.5		5	mA	See Figure 14 and Figure 15
Output voltage trim range	14		33	V	See <i>Trim Characteristics of Application Note</i>
Output voltage remote sense range			1	V	
Output over-voltage protection	125		143	%	Over full temp range; % of $V_{o,nom}$ Latch: reset by power on or remote on
Over-temperature shutdown	105	115	130	°C	Auto recovery; Test point: see Figure 21
Over-temperature hysteresis	5			°C	
Reliability characteristics					
Calculated MTBF (telcordia)		1.5		10 ⁶ h	Telcordia SR-332-2006; 80% load, 300LFM, 40°C T _a

Qualification Testing

Parameter	Unit (pcs)	Test condition
Halt test	4 ~ 5	T _{a,min} -10°C to T _{a,max} +10°C, 5°C step, V _{in} = min to max, 0 ~ 105% load
Vibration	3	Frequency range: 5Hz ~ 20Hz, 20Hz ~ 200Hz, A.S.D: 1.0m ² /s ³ , -3db/oct, axes of vibration: X/Y/Z; Time: 30min/axis
Mechanical shock	3	30g, 6ms, 3axes, 6directions, 3time/direction
Thermal shock	3	-40°C to 100°C, unit temperature 20cycles
Thermal cycling	3	-40°C to 85°C, temperature change rate: 1°C/min, cycles: 2cycles
Humidity	3	40°C, 95%RH, 48h
Solder ability	15	IPC J-STD-002C-2007

Characteristic Curves

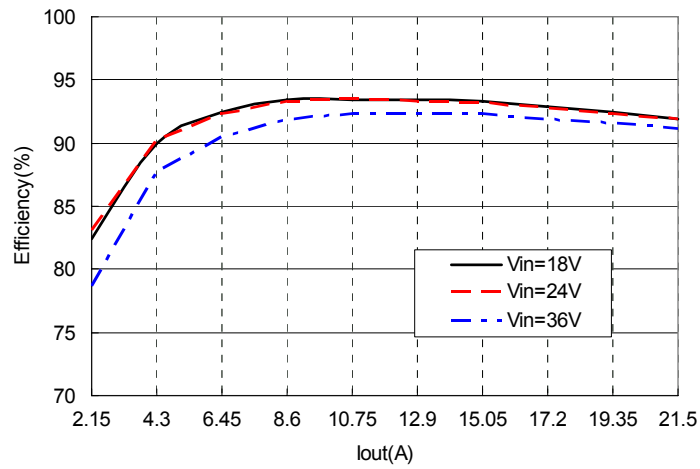

Figure 1 Efficiency vs. output current, T_a=25°C, V_o=28V

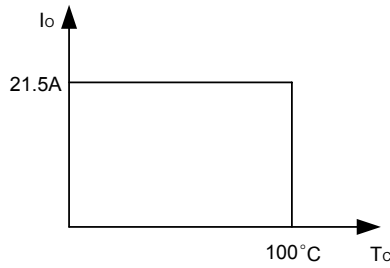

Figure 2 Output power derating curve

T_c: temperature test point on baseplate, see Figure 21 for test configuration.

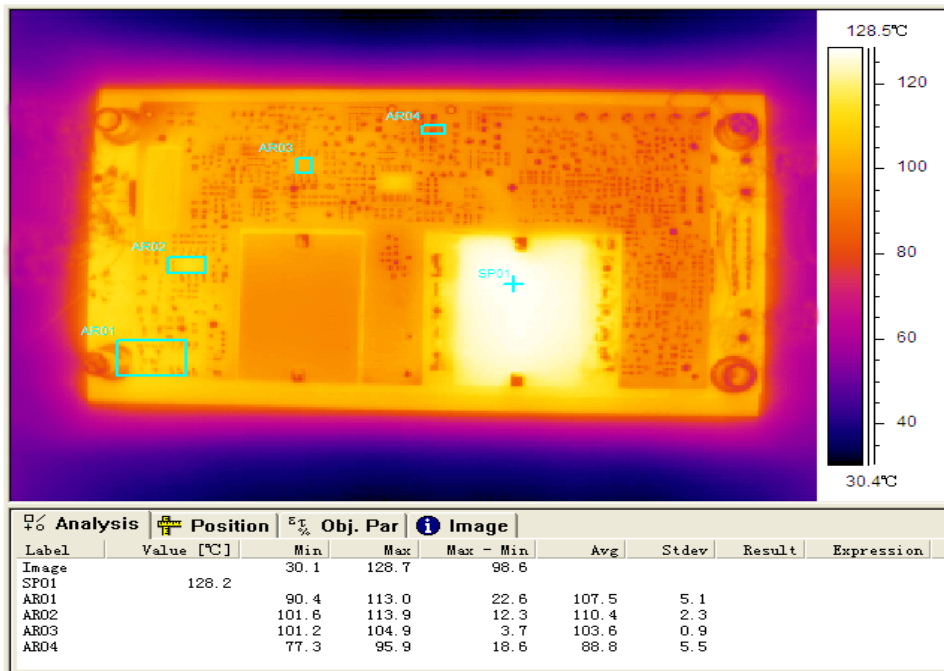

Figure 3 Thermal image, 24V_{in}, 28V_o, full load, room temperature

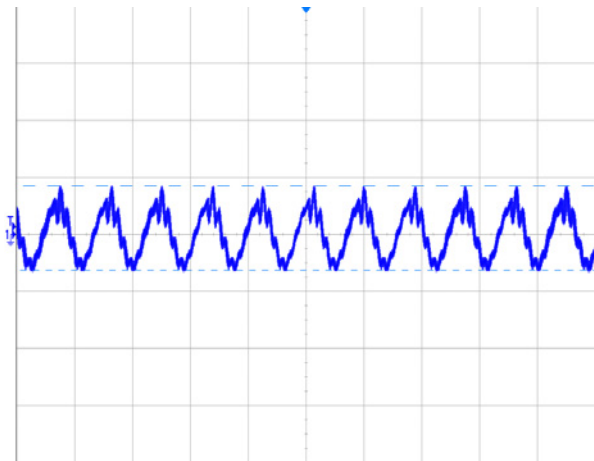

Figure 4 Output ripple & noise (5µs/div, 100mV/div), see Figure 18 for test configuration

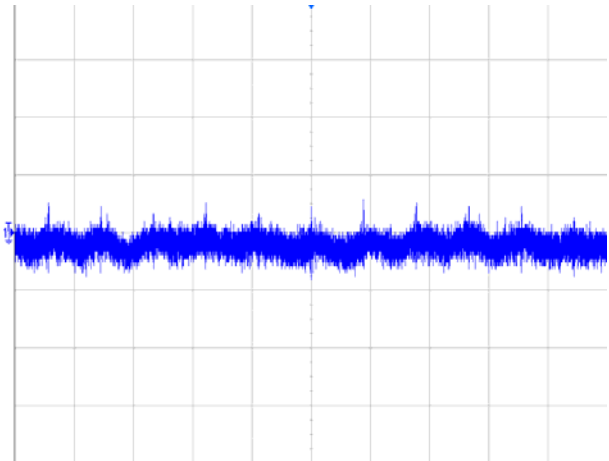

Figure 5 Input reflected ripple current (5µs/div, 20mA/div), see Figure 18 for test configuration

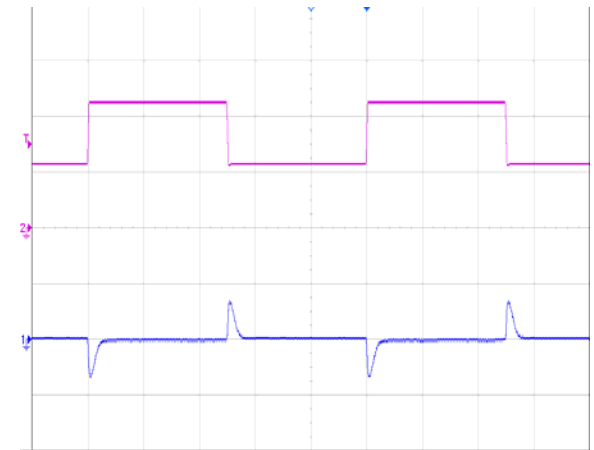

Figure 6 Dynamic response for 25% load step (25% ~ 50% ~ 75%) and 0.1A/µs slew rate, see Figure 13 for test configuration, CH1-output voltage (500mV/div); CH2-output current (5A/div)

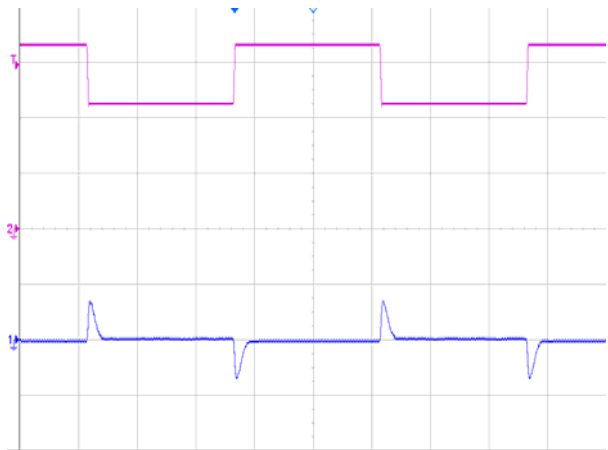

Figure 7 Dynamic response for 25% load step (50% ~ 75% ~ 50%) and 0.1A/µs slew rate, see Figure 13 for test configuration. CH1-output voltage (500mV/div); CH2-output current (5A/div)

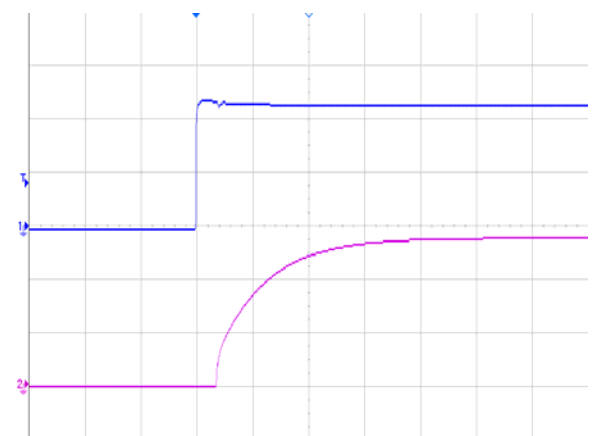

Figure 8 Output voltage startup by power on, (20ms/div), see Figure 13 for test configuration, CH1-input voltage (10V/div); CH2-output voltage (10V/div)

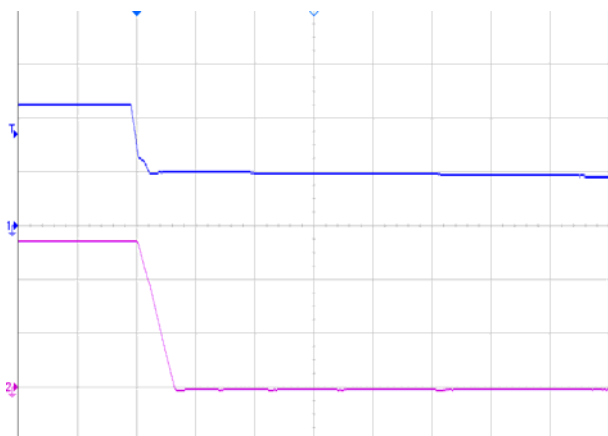

Figure 9 Output voltage shut down by power off, (2ms/div), see Figure 13 for test configuration, CH1-input voltage (10V/div); CH2-output voltage (10V/div)

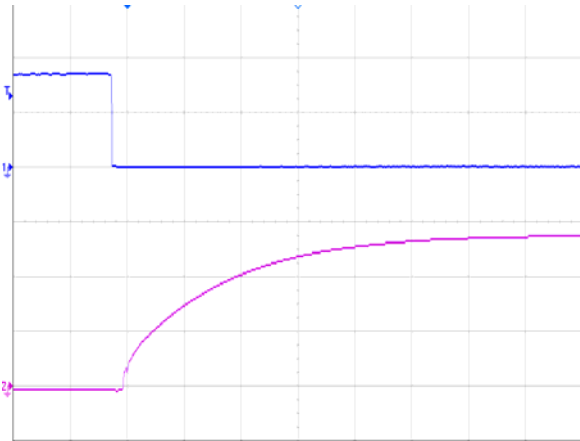

Figure10 Output voltage startup by remote ON, (10ms/div), see Figure 14 for test configuration, CH1-remote ON (2V/div); CH2-output voltage (10V/div)

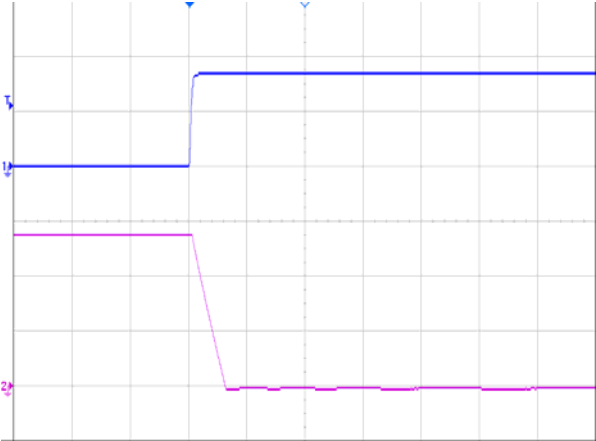

Figure 11 Output voltage shutdown by remote OFF, (2ms/div), see Figure 14 for test configuration, CH1-remote OFF (2V/div); CH2-output voltage (10V/div)

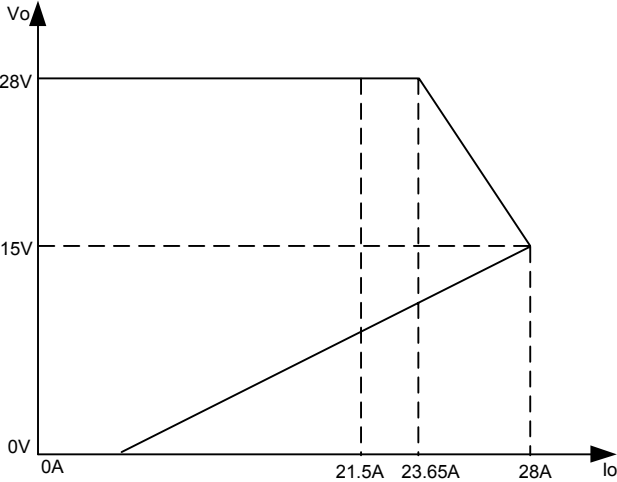

Figure 12 Over-current protection characteristics

(It's only a sketch map of OCP action. Little alteration of the current value vs. voltage value would be allowed.)

Application Note

Typical Application

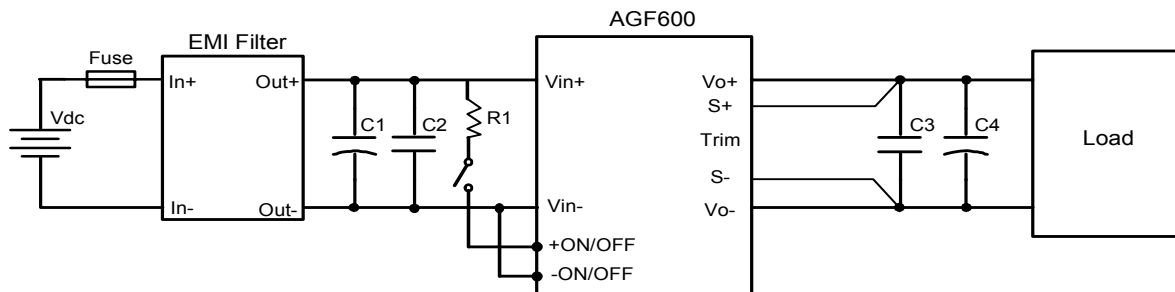

Figure 13 Typical application

R1: 10k Ω (1W) current limiting resistor

C1: 1000 μ F/50V electrolytic capacitor, P/N: UPW2A471MHD (Nichicon) or equivalent caps

C2, C3: 1 μ F/100V X7R ceramic capacitor, P/N: C3225X7R2A105KT0L0U(TDK) or equivalent caps

C4: 7X150 μ F electrolytic capacitor, P/N: UUD1H151MNL1GS (Nichicon) or equivalent caps

Note: If ambient temperature is below -5°C , additional 1000 μ F electrolytic capacitor is needed for output.

Fuse: External fast blow fuse with a rating of 60A. The recommended fuse model is F60AH (100/250V).

Remote ON/OFF

A remote ON/OFF control circuit is provided which is isolated from the input side, as well as, the output side. (Isolation withstand voltage: 1.5kV)

Connection of remote ON/OFF terminal is shown in the Figure 14. Output voltage turns remote on when current is made to flow through remote ON/OFF terminal. Remote ON/OFF terminal can be controlled by opening or closing connections (with switch or relay).

Maximum source current for remote ON/OFF terminal is 5mA. Therefore, current limiting resistor value must be set such that this maximum source current value is not exceeded. Also, the allowable maximum reverse current flow is 5mA.

Controlling the remote ON/OFF terminal from the input side

Connect current limiting resistor R1 as shown in Figure 14.

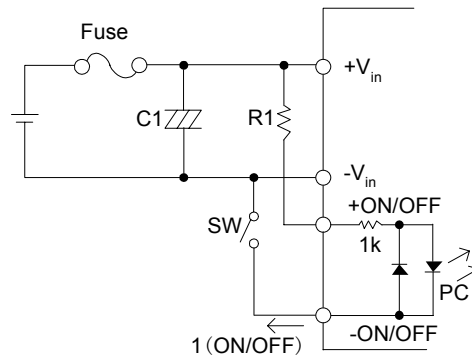

Figure 14 Connection of remote ON/OFF control (A)

R1: Recommended resistor value: 10kΩ (1W)

Controlling the remote ON/OFF terminal from the output side

Connect the current limiting resistor R1 as shown in Figure 15.

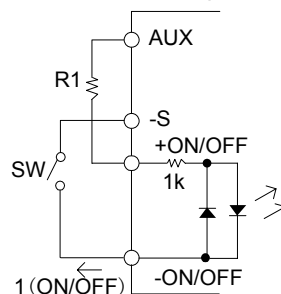

Figure 15 Connection of remote ON/OFF control (B)

R1: Recommended resistor Value: 2kΩ (1/2W)

Note:

1. A decoupling capacitor of about 0.1μF between the +remote ON/OFF terminal and –remote ON/OFF terminal is needed when input wiring is too long.
2. Current limiting resistor can also be connected to the –remote ON/OFF terminal side.

Remote ON/OFF level	Output status
Open (<100μA)	Remote OFF
1.5mA ≤ I (ON/OFF) ≤ 5mA	Remote ON

Trim Characteristics

The output voltage of the converter can be trimmed using the trim pin provided. Connecting an external resistor between Trim pin and V_{o-} pin will decrease the output voltage, while connecting it between +S and V_{o+} will increase the output voltage. Trimming down more than 50% and trimming up more than 18% can cause the module to regulate improperly. If the trim pin is not needed, it should be left open.

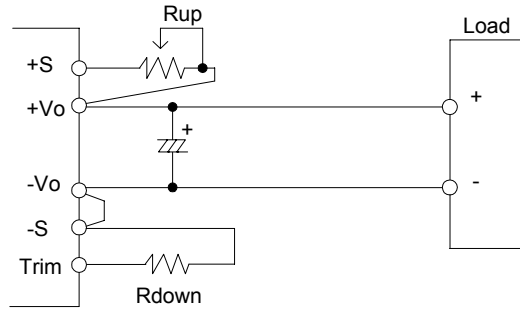

Figure 16 Trim circuit

$$R_{up} = 28 \left(\frac{V_o - V_e}{V_e} \right) k\Omega$$

$$R_{down} = -5.97 \left(\frac{V_o}{V_o - V_e} \right) k\Omega$$

V_e is the rated output voltage and V_o is the goal voltage.

For example, to get 30V output, the resistor is:

$$R_{up} = 28 \left(\frac{30 - 28}{28} \right) k\Omega = 2k\Omega$$

For another example, to get 14V output, the resistor is:

$$R_{down} = -5.97 \left(\frac{14}{14 - 28} \right) k\Omega = 5.97k\Omega$$

Note: Input voltage should be limited when output voltage increases, shown in the following figure.

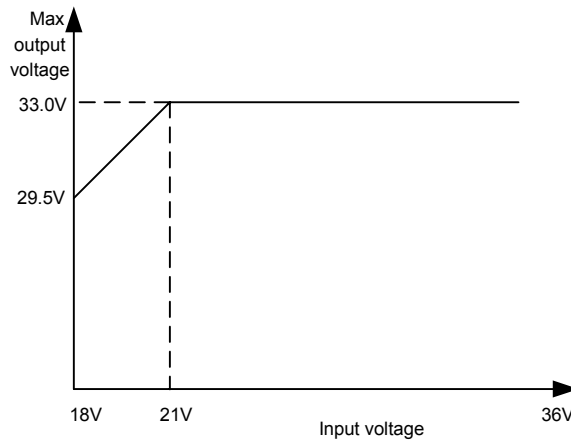

Figure 17 Trim-up voltage vs. input voltage

Sense Characteristics

If the load is far from the unit, connect S+ and S- to the terminal of the load respectively to compensate the voltage drop on the transmission line. See Figure 13.

If the sense compensate function is not necessary, short S+ to V_o+ and S- to V_o- respectively.

Input Ripple & Inrush Current and Output Ripple & Noise Test Configuration

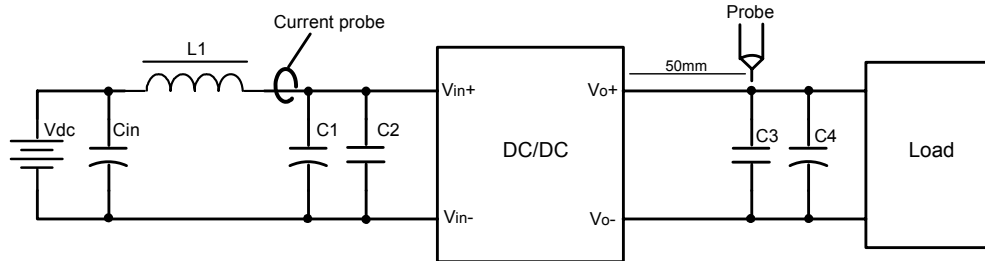

Figure 18 Input ripple & inrush current, ripple & noise test configuration

Vdc: DC power supply

L1: 12μH

Cin: 220μF/100V typical.

C1 ~ C4: See Figure 13

Note: Using a coaxial cable with series 50Ω resistor and 0.68μF ceramic capacitor or a ground ring of probe to test output ripple & noise is recommended.

EMC Filter Configuration

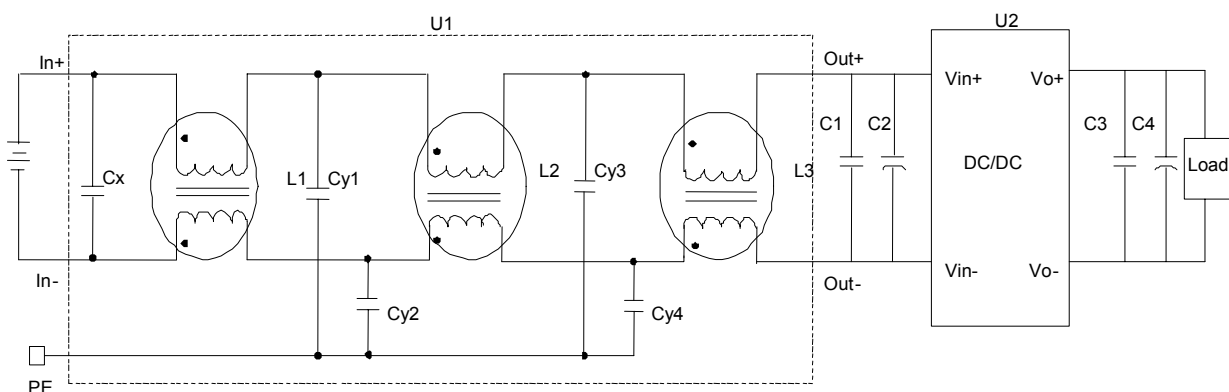

Figure 19 EMC test configuration

C_x: 5.7μF/100V capacitor

Cy1, Cy2, Cy3, Cy4: 4700pF, Y capacitor

L1, L2, L3: 100μH, common mode inductor

C1: 1000μF/50V electrolytic capacitor, P/N: UPW2A471MHD (Nichicon) or equivalent caps

C2, C3: 1μF/100V X7R ceramic capacitor, P/N: C3225X7R2A105KT0L0U(TDK) or equivalent caps

C4: 7X150μF electrolytic capacitor, P/N: UUD1H151MNL1GS (Nichicon) or equivalent caps

U1: 40A input EMC filter module (P/N: FM100-40)

U2: Module under test, AGF600-24S28

Mechanical Diagram

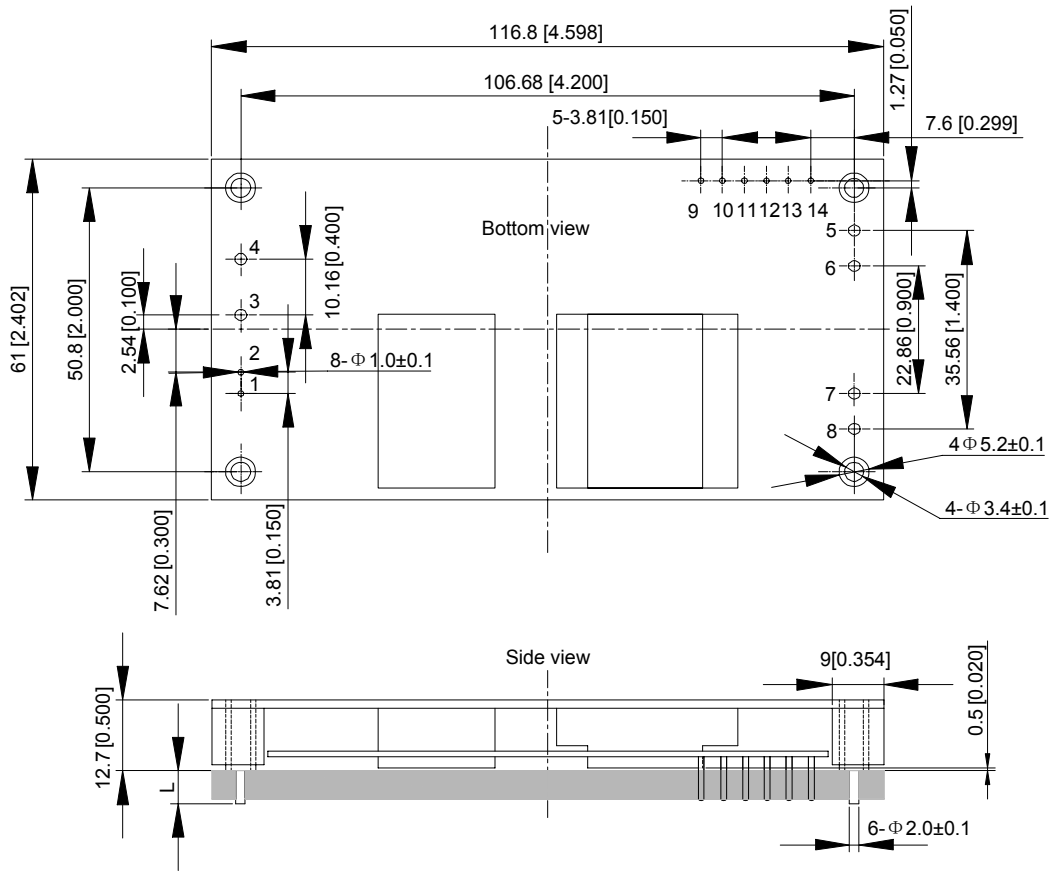

Unit: mm[inch] Bottom view: pin on upside
 Tolerance: X.Xmm±0.5mm[X.X in.±0.02in.]
 X.XXmm±0.25mm[X.XX in.±0.01in.]

Figure 20 Mechanical diagram

Pin length option

Device code suffix	L
-4	4.8mm±0.2mm
-6	3.8mm±0.2mm
-8	2.8mm±0.2mm
None	5.8mm±0.2mm

Pin Designations

Pin NO.	Name	Function
1	+On/Off	Remote control
2	-On/Off	Remote control
3	V _{in+}	Positive input voltage
4	V _{in-}	Negative input voltage
5, 6	V _{o-}	Negative output voltage
7, 8	V _{o+}	Positive output voltage
9	AUX	Auxiliary voltage
10	I OG	Inverter operation good
11	PC	Parallel operation
12	Trim	Trim terminal
13	+S	Remote sensing +
14	-S	Remote sensing -

Soldering

The product is intended for standard manual or wave soldering.

When wave soldering is used, the temperature on pins is specified to maximum 260°C for maximum 7s.

When soldering by hand, the iron temperature should be maintained at 300°C ~ 380°C and applied to the converter pins for less than 10s. Longer exposure can cause internal damage to the converter.

Cleaning of solder joint can be performed with cleaning solvent IPA or similitive.

Thermal Considerations

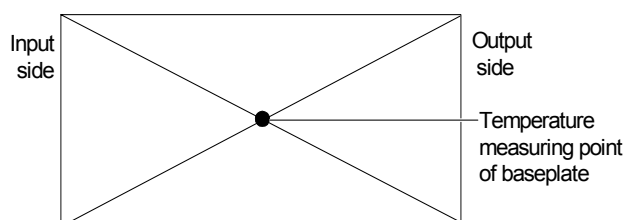

Figure 21 Temperature test point on base plate

Ordering Information

AGF600	-	24	S	28	-	6	L
①		②	③	④		⑤	⑥

①	Model series	AGF: high efficiency full brick series; 600: output power 600W
②	Input voltage	24: 18V ~ 36V input range, rated input voltage 24V
③	Output channel	S: single output
④	Rated output voltage	28: 28V output
⑤	Pin length	-6: 3.8mm
⑥	RoHS status	L: RoHS, R6; Y: RoHS, R5

Model number	Description
AGF600-24S28-6L	3.8mm pin length; without thread inside mounting hole; R6 compliat
AGF600-24S28-6Y	3.8mm pin length; without thread inside mounting hole; R5 compliat

Hazardous Substances Announcement (RoHS of China)

Parts	Hazardous substances					
	Pb	Hg	Cd	Cr6+	PBB	PBDE
AGF600-24S28-6L	○	○	○	○	○	○
AGF600-24S28-6Y	√	○	○	○	○	○

○: Means the content of the hazardous substances in all the average quality materials of the part is within the limits specified in SJ/T-11363-2006

√: Means the content of the hazardous substances in at least one of the average quality materials of the part is outside the limits specified in SJ/T11363-2006

Emerson Network Power Co., Ltd. has been committed to the design and manufacturing of environment-friendly products. It will reduce and eventually eliminate the hazardous substances in the products through unremitting efforts in research. However, limited by the current technical level, the following parts still contain hazardous substances due to the lack of reliable substitute or mature solution:

1. Solders (including high-temperature solder in parts) contain plumbum.
2. Glass of electric parts contains plumbum.
3. Copper alloy of pins contains plumbum

Данный компонент на территории Российской Федерации

Вы можете приобрести в компании MosChip.

Для оперативного оформления запроса Вам необходимо перейти по данной ссылке:

<http://moschip.ru/get-element>

Вы можете разместить у нас заказ для любого Вашего проекта, будь то серийное производство или разработка единичного прибора.

В нашем ассортименте представлены ведущие мировые производители активных и пассивных электронных компонентов.

Нашей специализацией является поставка электронной компонентной базы двойного назначения, продукции таких производителей как XILINX, Intel (ex.ALTERA), Vicor, Microchip, Texas Instruments, Analog Devices, Mini-Circuits, Amphenol, Glenair.

Сотрудничество с глобальными дистрибьюторами электронных компонентов, предоставляет возможность заказывать и получать с международных складов практически любой перечень компонентов в оптимальные для Вас сроки.

На всех этапах разработки и производства наши партнеры могут получить квалифицированную поддержку опытных инженеров.

Система менеджмента качества компании отвечает требованиям в соответствии с ГОСТ Р ИСО 9001, ГОСТ РВ 0015-002 и ЭС РД 009

Офис по работе с юридическими лицами:

105318, г.Москва, ул.Щербаковская д.3, офис 1107, 1118, ДЦ «Щербаковский»

Телефон: +7 495 668-12-70 (многоканальный)

Факс: +7 495 668-12-70 (доб.304)

E-mail: info@moschip.ru

Skype отдела продаж:

moschip.ru

moschip.ru_4

moschip.ru_6

moschip.ru_9