

NX-series EtherCAT Coupler Unit

NX-ECC

CSM_NX-ECC_DS_E_5_1

Combine flexibility in Remote I/O configuration with the speed and determinism of EtherCAT.

- The EtherCAT Coupler Unit is the link between the EtherCAT Machine Control network and the NX-series I/O Units. With I/O Units ranging from basic I/O's to high-speed synchronous models, the NX-series is the perfect match for the Sysmac Machine Automation Controllers.



Features

- Up to 63 NX-IO Units can be connected to one EtherCAT Coupler Unit. Standard and high-performance units can be mixed.*
 - Each Coupler plus its I/O form just a single EtherCAT node on the network.
 - I/O control and safety control can be integrated by connecting Units for safety.
 - The Coupler supports the EtherCAT Distributed Clock (DC) and propagates this to synchronous I/O units.
 - The node address can be fixed by rotary switches, or set by software. Choose the method that best suits your way of engineering.
 - Slave configuration by Sysmac Studio can be done centrally via the controller, or on-the-spot using the Coupler's built-in USB port.
- * Input per Coupler Unit: Maximum 1024 bytes, Output per Coupler Unit: Maximum 1024 bytes

System Configuration

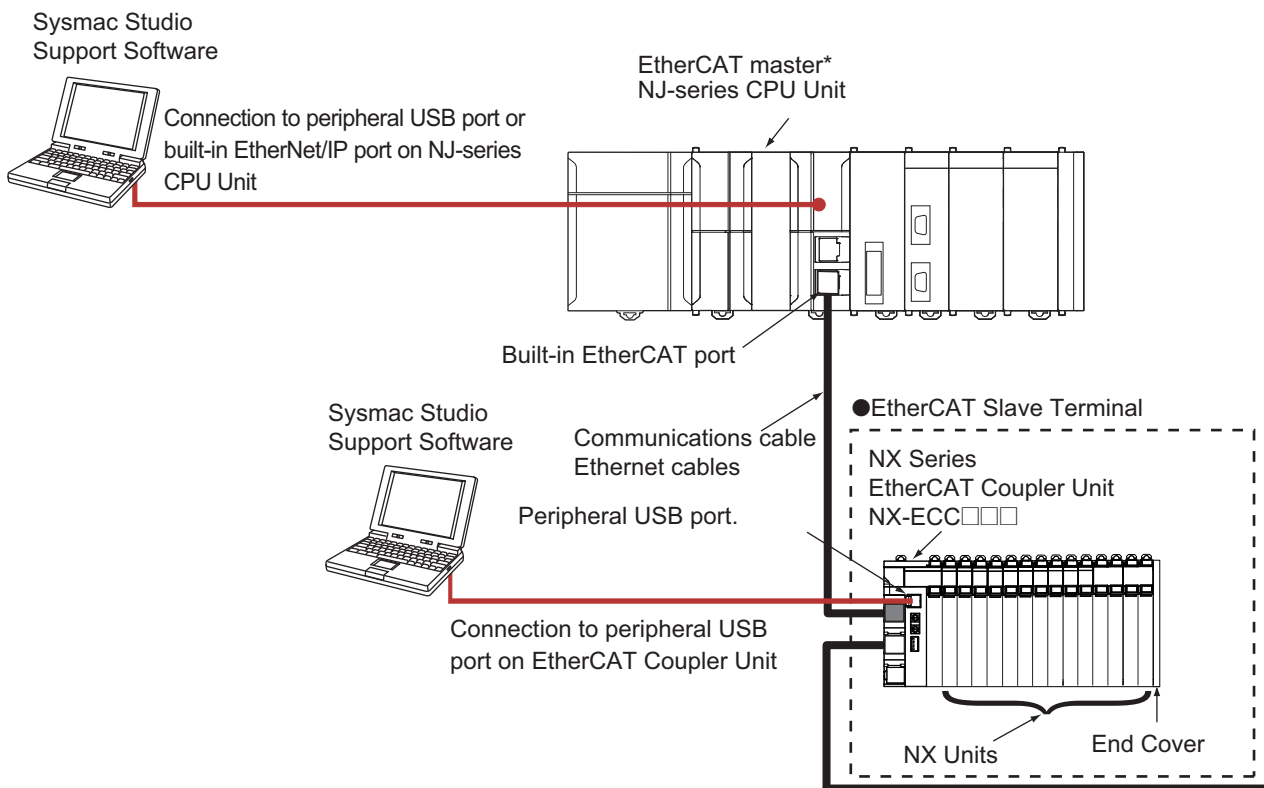

* OMRON CJ1W-NC□81/□82 Position Control Units cannot be connected to the EtherCAT Slave Terminal even though they support EtherCAT.

Sysmac® is a trademark or registered trademark of OMRON Corporation in Japan and other countries for OMRON factory automation products.

EtherCAT® is a registered trademark of Beckhoff Automation GmbH for their patented technology. Other company names and product names in this document are the trademarks or registered trademarks of their respective companies.

Ordering Information

International Standards





- The standards are abbreviated as follows: U: UL, U1: UL(Class I Division 2 Products for Hazardous Locations), C: CSA, UC: cULus, UC1: cULus (Class I Division 2 Products for Hazardous Locations), CU: cUL, N: NK, L: Lloyd, CE: EC Directives, and KC: KC Registration.
- Contact your OMRON representative for further details and applicable conditions for these standards.

Unit type	Product Name	Current consumption	Maximum I/O power supply current	Model	Standards
NX Series EtherCAT Coupler Unit		1.45 W or lower	4 A	NX-ECC201	UC1, N, L, CE, KC
			10 A	NX-ECC202	

Recommended EtherCAT Communications Cables

Use Straight STP (shielded twisted-pair) cable of category 5 or higher with double shielding (braiding and aluminum foil tape) for EtherCAT.

Cable with Connectors

Item	Appearance	Recommended manufacturer	Cable length(m) *1	Model
Standard type Cable with Connectors on Both Ends (RJ45/RJ45) Wire Gauge and Number of Pairs: AWG27, 4-pair Cable Cable Sheath material: LSZH *2 Cable color: Yellow *3		OMRON	0.3	XS6W-6LSZH8SS30CM-Y
			0.5	XS6W-6LSZH8SS50CM-Y
			1	XS6W-6LSZH8SS100CM-Y
			2	XS6W-6LSZH8SS200CM-Y
			3	XS6W-6LSZH8SS300CM-Y
			5	XS6W-6LSZH8SS500CM-Y
Rugged type Cable with Connectors on Both Ends (RJ45/RJ45) Wire Gauge and Number of Pairs: AWG22, 2-pair Cable		OMRON	0.3	XS5W-T421-AMD-K
			0.5	XS5W-T421-BMD-K
			1	XS5W-T421-CMD-K
			2	XS5W-T421-DMD-K
			5	XS5W-T421-GMD-K
			10	XS5W-T421-JMD-K
Rugged type Cable with Connectors on Both Ends (M12 Straight/RJ45) Wire Gauge and Number of Pairs: AWG22, 2-pair Cable		OMRON	0.3	XS5W-T421-AMC-K
			0.5	XS5W-T421-BMC-K
			1	XS5W-T421-CMC-K
			2	XS5W-T421-DMC-K
			5	XS5W-T421-GMC-K
			10	XS5W-T421-JMC-K
Rugged type Cable with Connectors on Both Ends (M12 Right-angle/RJ45) Wire Gauge and Number of Pairs: AWG22, 2-pair Cable		OMRON	0.3	XS5W-T422-AMC-K
			0.5	XS5W-T422-BMC-K
			1	XS5W-T422-CMC-K
			2	XS5W-T422-DMC-K
			5	XS5W-T422-GMC-K
			10	XS5W-T422-JMC-K

*1 Standard type cables length 0.2, 0.3, 0.5, 1, 1.5, 2, 3, 5, 7.5, 10, 15 and 20m are available.

Rugged type cables length 0.3, 0.5, 1, 2, 3, 5, 10 and 15m are available.

*2 The lineup features Low Smoke Zero Halogen cables for in-cabinet use and PUR cables for out-of-cabinet use.

*3 Cables colors are available in blue, yellow, or Green

Note: For details, refer to Cat.No.G019.

Cables / Connectors

Wire Gauge and Number of Pairs: AWG24, 4-pair Cable

Item	Appearance	Recommended manufacturer	Model
Cables	-	Hitachi Metals, Ltd.	NETSTAR-C5E SAB 0.5 x 4P*
	-	Kuramo Electric Co.	KETH-SB*
	-	SWCC Showa Cable Systems Co.	FAE-5004*
RJ45 Connectors	-	Panduit Corporation	MPS588-C*

* We recommend you to use above cable and connector together.

Wire Gauge and Number of Pairs: AWG22, 2-pair Cable

Item	Appearance	Recommended manufacturer	Model
Cables	-	Kuramo Electric Co.	KETH-PSB-OMR*
	-	Nihon Electric Wire&Cable Co.,Ltd.	PNET/B*
RJ45 Assembly Connector		OMRON	XS6G-T421-1*

* We recommend you to use above cable and connector together.

Note: Connect both ends of cable shielded wires to the connector hoods.

Optional Products

Product name	Specification	Model	Standards			
Unit/Terminal Block Coding Pins	Pins for 10 Units (30 terminal block pins and 30 Unit pins)	NX-AUX02	---			
Product Name	Specification				Model	Standards
	No. of terminals	Terminal number indications	Ground terminal mark	Terminal current capacity		
Terminal Block	8	A/B	Provided	10 A	NX-TBC082	---

Accessories

End Cover (NX-END01)

An End Cover is connected to the end of the EtherCAT Slave Terminal.

One End Cover is provided together with the EtherCAT Coupler Unit.

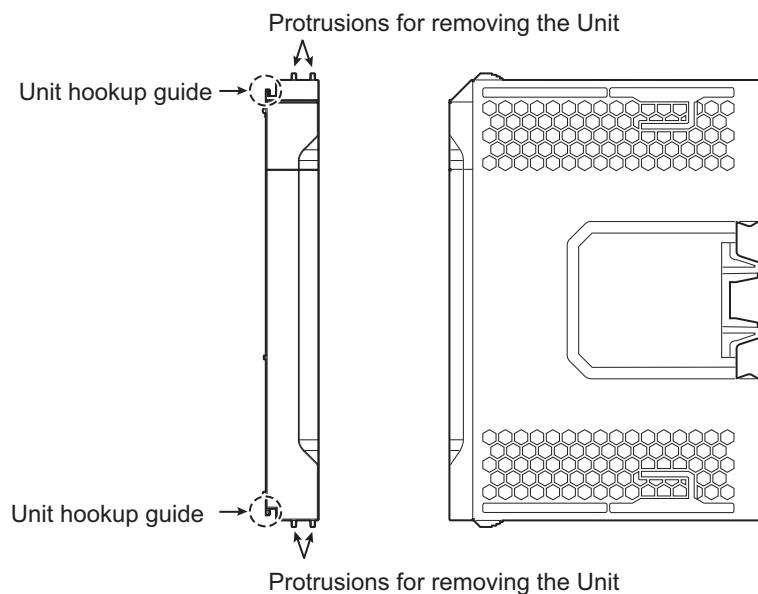

General Specification

Item		Specification
Enclosure		Mounted in a panel
Grounding method		Ground to 100 Ω or less
Operating environment	Ambient operating temperature	0 to 55°C
	Ambient operating humidity	10% to 95% (with no condensation or icing)
	Atmosphere	Must be free from corrosive gases.
	Ambient storage temperature	-25 to 70°C (with no condensation or icing)
	Altitude	2,000 m max.
	Pollution degree	Pollution degree 2 or less: Conforms to JIS B3502 and IEC 61131-2.
	Noise immunity	Conforms to IEC61000-4-4. 2 kV (power supply line)
	Overvoltage category	Category II: Conforms to JIS B3502 and IEC 61131-2.
	EMC immunity level	Zone B
	Vibration resistance	Conforms to IEC 60068-2-6. 5 to 8.4 Hz with 3.5-mm amplitude, 8.4 to 150 Hz, acceleration of 9.8 m/s ² , 100 min each in X, Y, and Z directions (10 sweeps of 10 min each = 100 min total)
Shock resistance	Conforms to IEC 60068-2-27. 147 m/s ² , 3 times each in X, Y, and Z directions	
Applicable standards		cULus: Listed UL508 and ANSI/ISA 12.12.01 EC: EN 61131-2 and C-Tick, KC Registration, NK, LR

Specifications

EtherCAT Coupler Unit NX-ECC201

Item		Specification	
Model		NX-ECC201	NX-ECC202
No. of connectable NX Units		63 Units max. ^{*1}	
Send/receive PDO data sizes		Input: 1,024 bytes max. (including input data, status, and unused areas) Output: 1,024 bytes max. (including output data and unused areas)	
Mailbox data size		Input: 256 bytes Output: 256 bytes	
Mailbox		Emergency messages, SDO requests, and SDO information	
Refreshing methods		Free-run refreshing I/O-synchronized refreshing Time stamp refreshing	
Node address setting range		1 to 192 ^{*2}	
I/O jitter performance		Inputs: 1 μs max. Outputs: 1 μs max.	
Communications cycle		250 to 100,000 μs ^{*3,4}	
Unit power supply	Power supply voltage	24 VDC (20.4 to 28.8 VDC) ^{*5}	
	NX Unit power supply capacity	10 W max. Refer to Installation orientation and restrictions for details.	
	NX Unit power supply efficiency	70%	
	Isolation method	No isolation between NX Unit power supply and Unit power supply terminals	
	Unwired terminal current capacity	4 A max.	
I/O power supply	Power supply voltage	5 to 24 VDC (4.5 to 28.8 VDC)	
	Maximum I/O power supply current	4 A max.	10 A max.
	Power supply terminal current capacity	4 A max.	10 A max.
NX Unit power consumption		1.45 W max.	
Current consumption from I/O power supply		10 mA max. (for 24 VDC)	
Dielectric strength		510 VAC for 1 min, leakage current: 5 mA max. (between isolated circuits)	
Insulation resistance		100 VDC, 20 MΩ min. (between isolated circuits)	

*1. Refer to the *NX-series Safety Control Units User's Manual* (Cat. No. Z930) for the number of Safety Control Units that can be connected.

*2. This specification applies to a connection to the built-in EtherCAT port on an NJ-series CPU Unit.

*3. This depends on the specifications of the EtherCAT master. The values are as follows when you are connected to the built-in EtherCAT port on an NJ5-series CPU Unit: 500 μs, 1,000 μs, 2,000 μs, and 4,000 μs. Refer to the *NJ-series CPU Unit Built-in EtherCAT Port User's Manual* (Cat. No. W505) for the most recent specifications.

*4. This depends on the Unit configuration.

*5. Use an output voltage that is appropriate for the I/O circuits of the NX Units and the connected external devices.

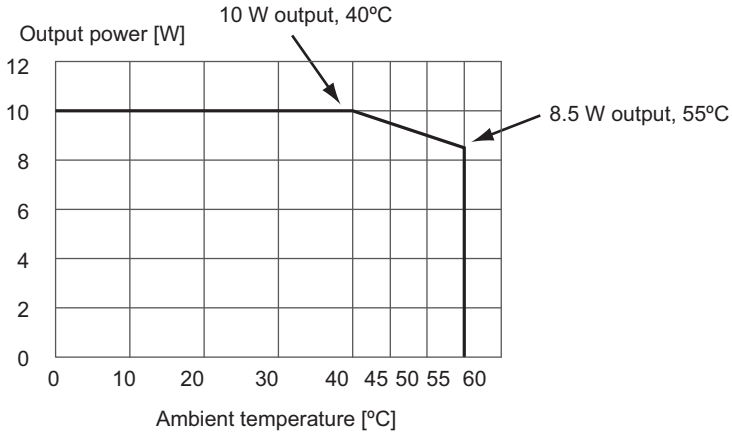
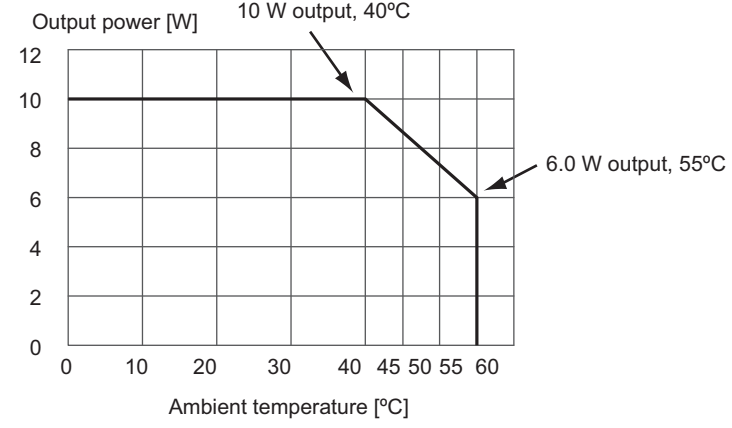
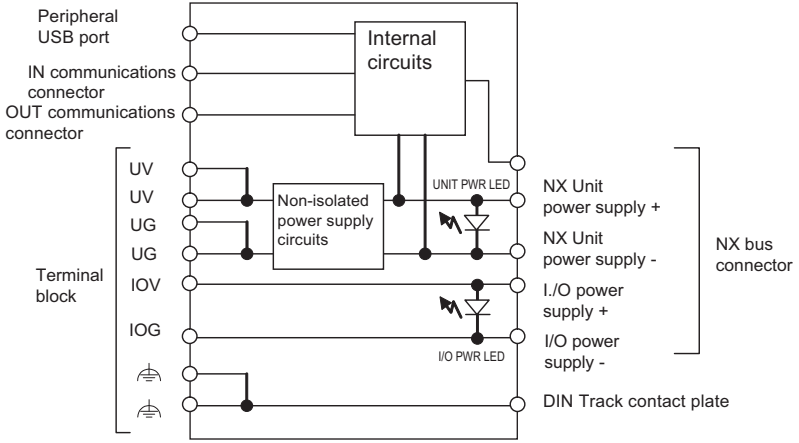
Item	Specification
External connection terminals	Communications Connector For EtherCAT communications. • RJ45 × 2 (shielded) • IN: EtherCAT input data, OUT: EtherCAT output data
	Screwless Clamping Terminal Block (8 terminals) For Unit power supply, I/O power supply, and grounding. Removable.
	Peripheral USB Port For Sysmac Studio connection. • Physical layer: USB 2.0-compliant, B-type connector • Transmission distance: 5 m max.
Dimensions	46 × 100 × 71 mm (W × H × D)
Weight	170 g max.
Installation orientation and restrictions	Installation orientation: 6 possible orientations Restrictions: • Used in the upright installation orientation. 
	• Used in another orientation other than the upright installation orientation. 
Circuit layout	

Item	Specification
Terminal arrangement	<p>Unit power supply (24 VDC)</p> <p>I/O power supply (5 to 24 VDC)</p> <p>Ground to 100Ω or less</p> <p>Through-wiring for unwired terminals.</p>
Accessory	End Cover (NX-END0): 1

EtherCAT Communications Specifications

Item	Specification
Communications standard	IEC 61158 Type 12
Physical layer	100BASE-TX (IEEE 802.3)
Modulation	Baseband
Baud rate	100 Mbps
Topology	Depends on the specifications of the EtherCAT master.
Transmission media	Category 5 or higher twisted-pair cable (Recommended cable: double-shielded cable with aluminum tape and braiding)
Transmission distance	Distance between nodes: 100 m or less

Version Information

NX Units		Corresponding unit versions/versions	
Model	Unit Version	NJ-series CPU Units NJ501-□□□□/NJ301-□□□□	Sysmac Studio
NX-ECC201	Ver.1.2	Version 1.07 or later	Version 1.08 or higher
	Ver.1.1	Version 1.05 or later	Version 1.07 or higher
	Ver.1.0	Version 1.06 or later	Version 1.06 or higher
NX-ECC202	Ver.1.2 *	Version 1.07 or later	Version 1.08 or higher

* For the NX-ECC202, there is no unit version of 1.1 or earlier.

External Interface

EtherCAT Coupler Unit NX-ECC201

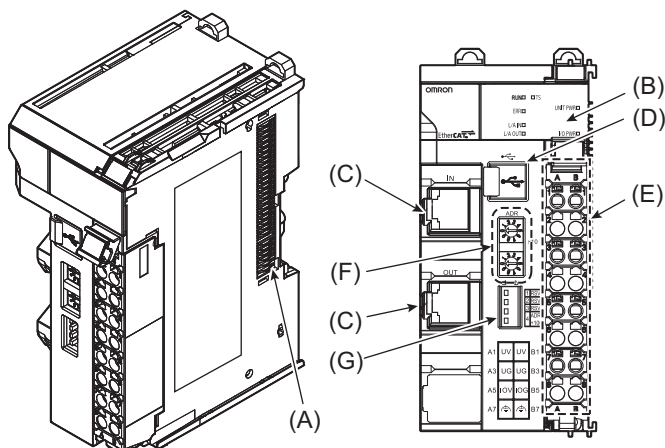

Symbol	Name	Function
(A)	NX bus connector	This connector is used to connect each Unit.
(B)	Indicators	The indicators show the current operating status of the Unit.
(C)	Communications connectors	These connectors are connected to the communications cables of the EtherCAT network. There are two connectors, one for the input port and one for the output port.
(D)	Peripheral USB port	This port is used to connect to the Sysmac Studio Support Software.
(E)	Terminal block	The terminal block is used to connect external devices. The number of terminals depends on the type of Unit.
(F)	Rotary switches	These rotary switches are used to set the 1s digit and 10s digit of the node address of the EtherCAT Coupler Unit as an EtherCAT slave. The address is set in decimal.
(G)	DIP switch	The DIP switch is used to set the 100s digit of the node address of the EtherCAT Coupler Unit as an EtherCAT slave.

Terminal Block

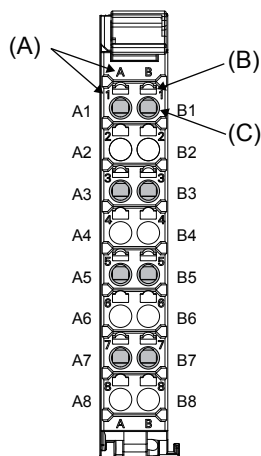

Eight-terminal Block

Symbol	Name	Function
(A)	Terminal number indications	The terminal numbers (A1 to A8 and B1 to B8) are displayed. The terminal number indicators are the same regardless of the number of terminals on the terminal block, as shown above.
(B)	Release holes	Insert a flat-blade screwdriver into these holes to connect and remove the wires.
(C)	Terminal holes	The wires are inserted into these holes.

Applicable Terminal Blocks for Each Unit Model

Unit model	Terminal Blocks				
	Model	No. of terminals	Terminal number indications	Ground terminal mark	Terminal current capacity
NX-ECC201	NX-TBC082	8	A/B	Provided	10 A
NX-ECC202	NX-TBC082	8	A/B	Provided	10 A

Applicable Wires

Using Ferrules

If you use ferrules, attach the twisted wires to them.

Observe the application instructions for your ferrules for the wire stripping length when attaching ferrules.

Always use plated one-pin ferrules. Do not use unplated ferrules or two-pin ferrules.

The applicable ferrules, wires, and crimping tool are given in the following table.

Terminal types	Manufacturer	Ferrule model	Applicable wire (mm ² (AWG))	Crimping tool
Terminals other than ground terminals	Phoenix Contact	AI0,34-8	0.34 (#22)	Phoenix Contact (The figure in parentheses is the applicable wire size.) CRIMPFOX 6 (0.25 to 6 mm ² , AWG 24 to 10)
		AI0,5-8	0.5 (#20)	
		AI0,5-10		
		AI0,75-8	0.75 (#18)	
		AI0,75-10		
		AI1,0-8	1.0 (#18)	
		AI1,0-10		
		AI1,5-8	1.5 (#16)	
		AI1,5-10		
Ground terminals		AI2,5-10	2.0 *1	
Terminals other than ground terminals	Weidmuller	H0.14/12	0.14 (#26)	Weidmueller (The figure in parentheses is the applicable wire size.) PZ6 Roto (0.14 to 6 mm ² , AWG 26 to 10)
		H0.25/12	0.25 (#24)	
		H0.34/12	0.34 (#22)	
		H0.5/14	0.5 (#20)	
		H0.5/16		
		H0.75/14	0.75 (#18)	
		H0.75/16		
		H1.0/14	1.0 (#18)	
		H1.0/16		
		H1.5/14	1.5 (#16)	
		H1.5/16		

*1. Some AWG 14 wires exceed 2.0 mm² and cannot be used in the screwless clamping terminal block.

When you use any ferrules other than those in the above table, crimp them to the twisted wires so that the following processed dimensions are achieved.

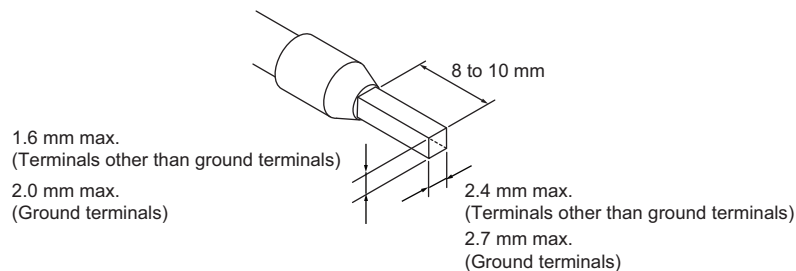

Using Twisted Wires/Solid Wires

If you use the twisted wires or the solid wires, use the following table to determine the correct wire specifications.

Terminals		Wire type		Wire plating		Wire size	Conductor length (stripping length)
Classification	Current capacity	Twisted wires	Solid wire	Plated	Unplated		
All terminals except ground terminals	2 A max.	Possible	Possible	Possible	Possible	0.08 to 1.5 mm ² AWG28 to 16	8 to 10 mm
	Greater than 2 A and 4 A or less				Not Possible		
	Greater than 4 A				Not Possible		
Ground terminals *	---		Possible		Possible	2.0 mm ²	9 to 10 mm

* With the NX-TB□□□1 Terminal Block, use twisted wires to connect the ground terminal. Do not use a solid wire.

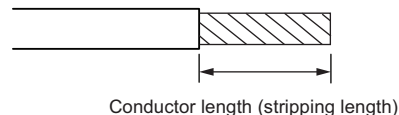

<Additional Information> If more than 2 A will flow on the wires, use plated wires or use ferrules.

Dimensions

EtherCAT Coupler Unit NX-ECC201

● EtherCAT Coupler Unit Only

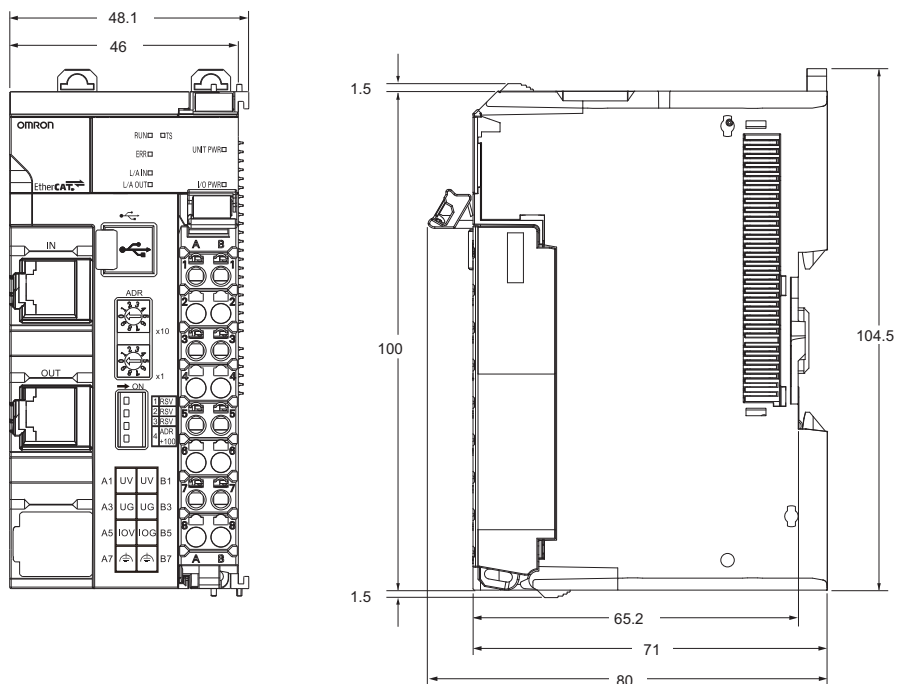

● With Cables Connected

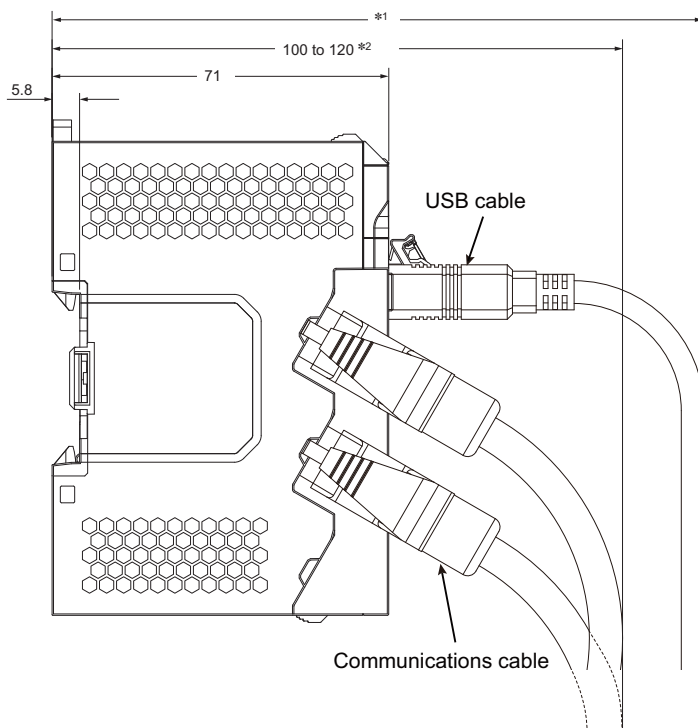

*1. This dimension depends on the specifications of the commercially available USB cable. Check the specifications of the USB cable that is used.

*2. This is the dimension from the back of the Unit to the communications cables.

- 100 mm: When an MPS588-C Connector is used.
- 120 mm: When an XS6G-T421-1 Connector is used.

● End Cover

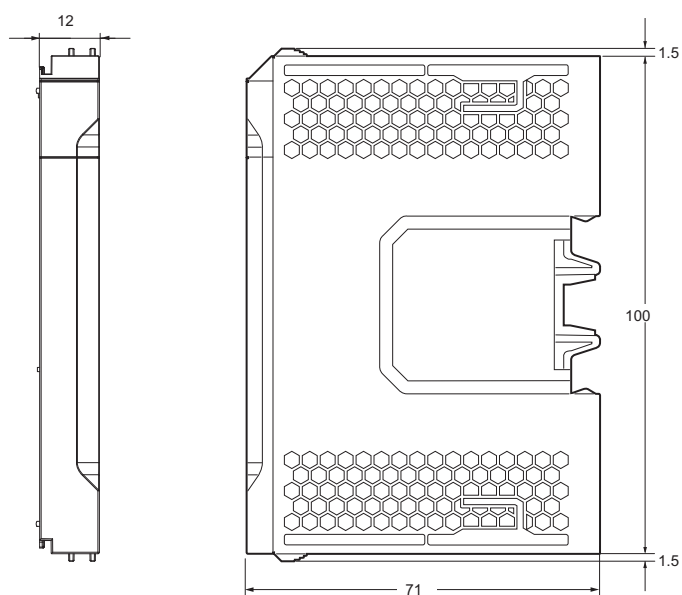

Related Manuals

Man. No	Model	Manual	Application	Description
W519	NX-ECC201 NX-ECC202	NX-series EtherCAT Coupler Unit User's Manual	Learning how to use an NX-series EtherCAT Coupler Unit and Ether-CAT Slave Terminals	The following items are described: the overall system and configuration methods of an EtherCAT Slave Terminal (which consists of an NX-series EtherCAT Coupler Unit and NX Units), and information on hardware, setup, and functions to set up, control, and monitor NX Units through EtherCAT.

Terms and Conditions Agreement

Read and understand this catalog.

Please read and understand this catalog before purchasing the products. Please consult your OMRON representative if you have any questions or comments.

Warranties.

(a) Exclusive Warranty. Omron's exclusive warranty is that the Products will be free from defects in materials and workmanship for a period of twelve months from the date of sale by Omron (or such other period expressed in writing by Omron). Omron disclaims all other warranties, express or implied.

(b) Limitations. OMRON MAKES NO WARRANTY OR REPRESENTATION, EXPRESS OR IMPLIED, ABOUT NON-INFRINGEMENT, MERCHANTABILITY OR FITNESS FOR A PARTICULAR PURPOSE OF THE PRODUCTS. BUYER ACKNOWLEDGES THAT IT ALONE HAS DETERMINED THAT THE PRODUCTS WILL SUITABLY MEET THE REQUIREMENTS OF THEIR INTENDED USE.

Omron further disclaims all warranties and responsibility of any type for claims or expenses based on infringement by the Products or otherwise of any intellectual property right. (c) Buyer Remedy. Omron's sole obligation hereunder shall be, at Omron's election, to (i) replace (in the form originally shipped with Buyer responsible for labor charges for removal or replacement thereof) the non-complying Product, (ii) repair the non-complying Product, or (iii) repay or credit Buyer an amount equal to the purchase price of the non-complying Product; provided that in no event shall Omron be responsible for warranty, repair, indemnity or any other claims or expenses regarding the Products unless Omron's analysis confirms that the Products were properly handled, stored, installed and maintained and not subject to contamination, abuse, misuse or inappropriate modification. Return of any Products by Buyer must be approved in writing by Omron before shipment. Omron Companies shall not be liable for the suitability or unsuitability or the results from the use of Products in combination with any electrical or electronic components, circuits, system assemblies or any other materials or substances or environments. Any advice, recommendations or information given orally or in writing, are not to be construed as an amendment or addition to the above warranty.

See <http://www.omron.com/global/> or contact your Omron representative for published information.

Limitation on Liability; Etc.

OMRON COMPANIES SHALL NOT BE LIABLE FOR SPECIAL, INDIRECT, INCIDENTAL, OR CONSEQUENTIAL DAMAGES, LOSS OF PROFITS OR PRODUCTION OR COMMERCIAL LOSS IN ANY WAY CONNECTED WITH THE PRODUCTS, WHETHER SUCH CLAIM IS BASED IN CONTRACT, WARRANTY, NEGLIGENCE OR STRICT LIABILITY.

Further, in no event shall liability of Omron Companies exceed the individual price of the Product on which liability is asserted.

Suitability of Use.

Omron Companies shall not be responsible for conformity with any standards, codes or regulations which apply to the combination of the Product in the Buyer's application or use of the Product. At Buyer's request, Omron will provide applicable third party certification documents identifying ratings and limitations of use which apply to the Product. This information by itself is not sufficient for a complete determination of the suitability of the Product in combination with the end product, machine, system, or other application or use. Buyer shall be solely responsible for determining appropriateness of the particular Product with respect to Buyer's application, product or system. Buyer shall take application responsibility in all cases.

NEVER USE THE PRODUCT FOR AN APPLICATION INVOLVING SERIOUS RISK TO LIFE OR PROPERTY OR IN LARGE QUANTITIES WITHOUT ENSURING THAT THE SYSTEM AS A WHOLE HAS BEEN DESIGNED TO ADDRESS THE RISKS, AND THAT THE OMRON PRODUCT(S) IS PROPERLY RATED AND INSTALLED FOR THE INTENDED USE WITHIN THE OVERALL EQUIPMENT OR SYSTEM.

Programmable Products.

Omron Companies shall not be responsible for the user's programming of a programmable Product, or any consequence thereof.

Performance Data.

Data presented in Omron Company websites, catalogs and other materials is provided as a guide for the user in determining suitability and does not constitute a warranty. It may represent the result of Omron's test conditions, and the user must correlate it to actual application requirements. Actual performance is subject to the Omron's Warranty and Limitations of Liability.

Change in Specifications.

Product specifications and accessories may be changed at any time based on improvements and other reasons. It is our practice to change part numbers when published ratings or features are changed, or when significant construction changes are made. However, some specifications of the Product may be changed without any notice. When in doubt, special part numbers may be assigned to fix or establish key specifications for your application. Please consult with your Omron's representative at any time to confirm actual specifications of purchased Product.

Errors and Omissions.

Information presented by Omron Companies has been checked and is believed to be accurate; however, no responsibility is assumed for clerical, typographical or proofreading errors or omissions.

2015.2

In the interest of product improvement, specifications are subject to change without notice.

OMRON Corporation
Industrial Automation Company

<http://www.ia.omron.com/>

(c)Copyright OMRON Corporation 2015 All Right Reserved.

Mouser Electronics

Authorized Distributor

Click to View Pricing, Inventory, Delivery & Lifecycle Information:

Omron:

[NX-ECC202](#) [NX-END01](#) [NX-ECC201](#)

Данный компонент на территории Российской Федерации

Вы можете приобрести в компании MosChip.

Для оперативного оформления запроса Вам необходимо перейти по данной ссылке:

<http://moschip.ru/get-element>

Вы можете разместить у нас заказ для любого Вашего проекта, будь то серийное производство или разработка единичного прибора.

В нашем ассортименте представлены ведущие мировые производители активных и пассивных электронных компонентов.

Нашей специализацией является поставка электронной компонентной базы двойного назначения, продукции таких производителей как XILINX, Intel (ex.ALTERA), Vicor, Microchip, Texas Instruments, Analog Devices, Mini-Circuits, Amphenol, Glenair.

Сотрудничество с глобальными дистрибьюторами электронных компонентов, предоставляет возможность заказывать и получать с международных складов практически любой перечень компонентов в оптимальные для Вас сроки.

На всех этапах разработки и производства наши партнеры могут получить квалифицированную поддержку опытных инженеров.

Система менеджмента качества компании отвечает требованиям в соответствии с ГОСТ Р ИСО 9001, ГОСТ РВ 0015-002 и ЭС РД 009

Офис по работе с юридическими лицами:

105318, г.Москва, ул.Щербаковская д.3, офис 1107, 1118, ДЦ «Щербаковский»

Телефон: +7 495 668-12-70 (многоканальный)

Факс: +7 495 668-12-70 (доб.304)

E-mail: info@moschip.ru

Skype отдела продаж:

moschip.ru

moschip.ru_4

moschip.ru_6

moschip.ru_9