

Kunde / customer :

Artikelnummer / part number : **82 306 050 029**Datum / Date : **2007-01-24**

Bezeichnung :

description : **0603 ESD ULTRA LOW CAP TVS**SMD size: **0603**

ROHS Compliant

**A Mechanische Abmessungen / dimensions :**

SIZE

(Unit : mm)

| SIZE | W    | L   | T   | a    |
|------|------|-----|-----|------|
| 402  | 0.5  | 1.0 | 0.6 | 0.25 |
| 603  | 0.8  | 1.6 | 0.9 | 0.3  |
| 805  | 1.25 | 2.0 | 1.2 | 0.3  |
| 1206 | 1.6  | 3.2 | 1.5 | 0.5  |
| 1210 | 2.5  | 3.2 | 1.5 | 0.5  |
| 1812 | 3.2  | 4.5 | 2.0 | 0.5  |
| 2220 | 5.0  | 5.7 | 2.5 | 0.5  |

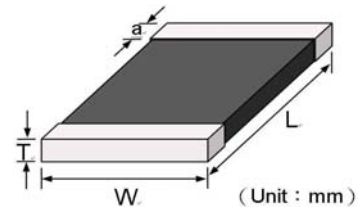
**B Elektrische Eigenschaften / electrical properties :**

## TECHNICAL DATA

| Part Number          | Working Voltage | Max. Clamping Voltage | Trigger Voltage | Leakage Current | ESD Pulse Withstand | ESD Voltage air discharge | Capacitance |
|----------------------|-----------------|-----------------------|-----------------|-----------------|---------------------|---------------------------|-------------|
|                      | DC              | V (*1)                | V               | μA (*2)         |                     | kV (*3)                   | pF          |
| <b>82306050029S1</b> | <b>5</b>        | <b>30 typ.</b>        | <b>150</b>      | <b>0.01</b>     | <b>&gt;100</b>      | <b>+/-15</b>              | <b>0.2</b>  |

\* 1 Max. Clamping Voltage at 8/20 waveform and 1 A pulse current

\* 2 Leakage Current at max operating voltage, the max leakage current was measured at reliability test

\* 3. ESD Typ. Withstands Voltage design and method guarantee this property

Capacitance measured at:

1MHz

Capacitance/Frequency DC to &amp; 1.8 GHz

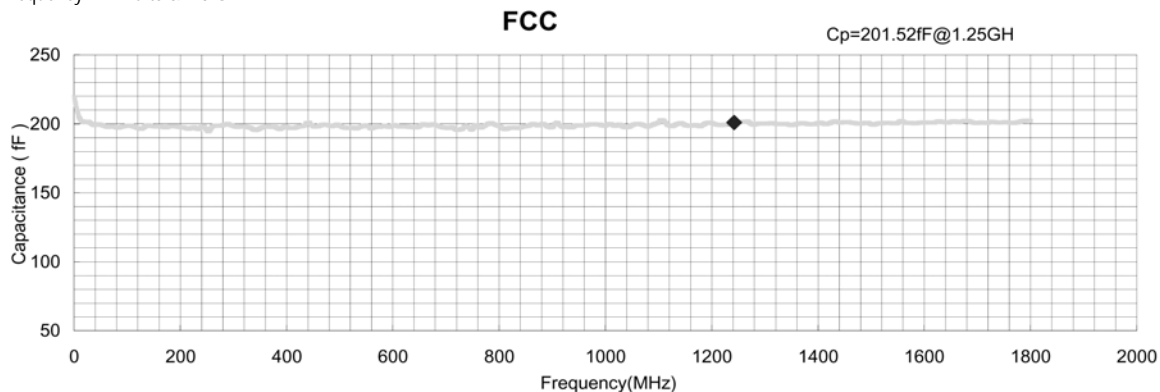

## REFERENCE DATA

|                               |            |   |          |    |
|-------------------------------|------------|---|----------|----|
| Response time                 | $T_{rise}$ | < | 1        | ns |
| Operating ambient temperature |            |   | -40~+85  | °C |
| Storage temperature           |            |   | -50~+125 | °C |
| Max. temperature solder       |            |   | 260/10s  | °C |

## OTHER DATA

|                        |              |
|------------------------|--------------|
| Body                   | ZnO          |
| End termination        | Ag/Ni/Sn     |
| Packaging              | Reel         |
| Complies with Standard | IEC61000-4-2 |
| Procedure              | Solgel       |
| Marking                | None         |

Kunde / customer :

Artikelnummer / part number : **82 306 050 029**

Bezeichnung :

description : **0603 ESD ULTRA LOW CAP TVS**

SMD size: **0603**

**C Lötpad / soldering spec. :**

RECOMMENDED SOLDER PAD LAYOUT

(Unit : mm)

| SISE | A       | B        | C       | D       |
|------|---------|----------|---------|---------|
| 402  | 0.4~0.6 | 1.0~1.8  | 0.6~0.7 | 0.6~1.2 |
| 603  | 0.8~1.2 | 1.7~3.0  | 1.2~1.6 | 0.9~1.8 |
| 805  | 1.0~1.5 | 2.1~3.8  | 1.5~2.1 | 1.1~2.3 |
| 1206 | 1.8~2.5 | 3.0~5.8  | 1.8~2.6 | 1.2~3.3 |
| 1210 | 1.8~2.5 | 3.2~6.1  | 2.8~3.8 | 1.3~3.5 |
| 1812 | 2.5~3.5 | 4.0~7.3  | 3.3~4.5 | 1.5~3.8 |
| 2220 | 3.5~4.6 | 5.0~8.5  | 5.2~6.2 | 1.5~3.9 |
| 3220 | 5.2~6.4 | 9.5~10.8 | 5.6~6.0 | 2.0~2.8 |

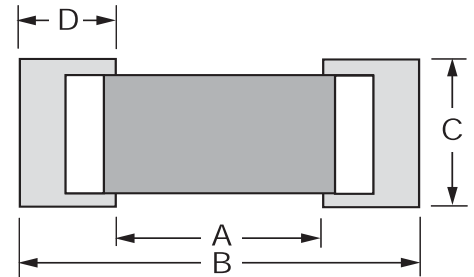

- 1 - The solder paste shall be printed in a thickness of 150 to 200µm.
- 2 - The SIR test of the solder paste shall be done (Based on JIS-Z-3284)
- 3 - IR reflow Pb Free Process suggestin profile (Based on J-STD-020-C):

Rapid heating, partial heating or rapid cooling will easily cause defect of the component. So preheating and gradual cooling process is suggested. IR soldering has the highest yields due to controlled heating rates and solder liquidus times. Make sure that the element is not subjected to a thermal gradient steeper than 3 degrees per second. 2 degrees per second is the ideal gradient. During the soldering process, pre- heating to within 175 degrees of the solders peak temperature is essential to minimize thermal shock.

Soldering recommend paste is Sn 96.5/Ag 3.5

- Preheat
  - 1.The temperature rising speed is suggested to be 2~3°C/s.
  - 2.Appropriate preheat time will be from 60 to 120 seconds.
  - 3.Temp. maintain at 175 +/-25°C 120 seconds.
- Heating
  - 1.Careful about sudden rise in temperature as it may worsen the solder ability.
  - 2.Set the peak temperature in 235°C 10-20s or 260°C 3-10s.
- Cooling
  - 1.Ramp down rate 6°C/s max.

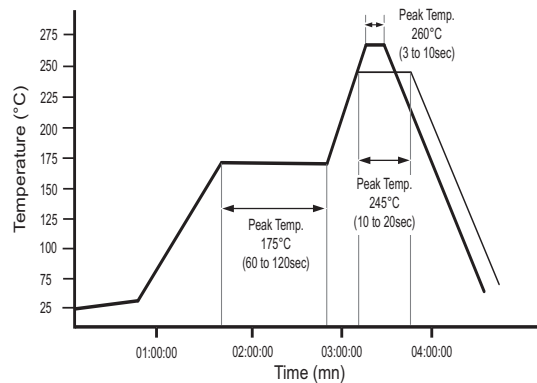

※Perform adequate test in advance as the reflow temperature profile will vary according to the conditions of the manufacturing process, and the specification of the reflow furnace

4 - Wave Soldering Process

- Ramp-up rate 3°C/s max.
- Temp. maintain at 175 +/-25°C 180 seconds max.
- Peak temperature 260°C 3-10s.
- Ramp down rate 6°C/s max.
- to thermal shock, a preheat is recommended in the soldering process. and the peak temperature should be under controlled rigidly in the solder process.

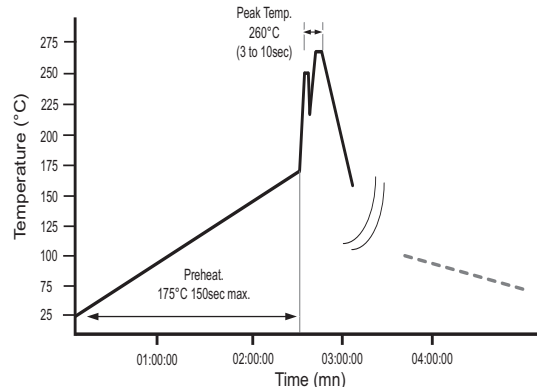

5 - Hand Soldering Process

- Preheating 150°C
- Temperature of soldering iron tip 380°C max. 3 to 5 sec
- The Varistors shall be cooled gradually at room ambient temperature

6 - Ultrasonic cleaning

For preventing failures or damages. Frequency 29MHz max - radied Power 20W/l max - Period 5mn max

Kunde / customer :

Artikelnummer / part number : 82 306 050 029

Bezeichnung :

description : 0603 ESD ULTRA LOW CAP TVS

SMD size: 0603

**D Rollenspezifikation / tape and reel specification :**

- 1 - Carrier tape and transparent cover tape should be heat-sealed to carry the products, and the reel should be used to reel the carrier tape.
- 2 - The adhesion of the heat-sealed cover tape shall be 40 + 20/ - 15grams.
- 3 - Both the head and the end portion of the taping shall be empty for reel package and SMT auto-pickup machine.  
And a normal paper tape shall be connected in the head of taping for the operator to handle.

(Unit : mm)

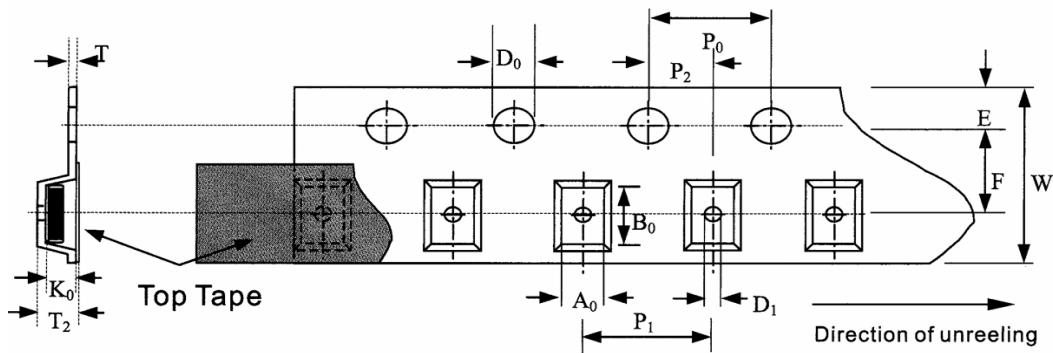

TAPE SPECIFICATION

(Unit : mm)

| Symbol      | A <sub>0</sub> | B <sub>0</sub> | K <sub>0</sub> | T <sub>2</sub> | T     | D <sub>0</sub> | D <sub>1</sub> | P <sub>1</sub> | P <sub>2</sub> | P <sub>0</sub> | W     | E     | F     |
|-------------|----------------|----------------|----------------|----------------|-------|----------------|----------------|----------------|----------------|----------------|-------|-------|-------|
|             | ±0.10          | ±0.10          | ±0.10          | ±0.05          | ±0.05 | +0.10          | ±0.05          | ±0.10          | ±0.05          | ±0.05          | ±0.20 | ±0.10 | ±0.05 |
| <b>402</b>  | 0.85           | 1.25           | 0.65           | 0.22           | 0.10  | 1.50           | 1.00           | 4.00           | 2.00           | 4.00           | 8.00  | 1.75  | 3.50  |
| <b>603</b>  | 1.05           | 1.88           | 0.95           | 0.22           | 0.10  | 1.50           | 1.00           | 4.00           | 2.00           | 4.00           | 8.00  | 1.75  | 3.50  |
| <b>805</b>  | 1.42           | 2.30           | 1.04           | 0.22           | 0.10  | 1.50           | 1.00           | 4.00           | 2.00           | 4.00           | 8.00  | 1.75  | 3.50  |
| <b>1206</b> | 1.88           | 3.50           | 1.27           | 0.2            | 0.10  | 1.50           | 1.00           | 4.00           | 2.00           | 4.00           | 8.00  | 1.75  | 3.50  |
| <b>1210</b> | 2.18           | 3.46           | 1.45           | 0.22           | 0.10  | 1.50           | 1.00           | 4.00           | 2.00           | 4.00           | 8.00  | 1.75  | 3.50  |
| <b>1812</b> | 3.66           | 4.95           | 1.74           | 0.25           | 0.10  | 1.50           | 1.50           | 8.00           | 2.00           | 4.00           | 12.00 | 1.75  | 5.50  |
| <b>2220</b> | 5.10           | 5.97           | 2.80           | 0.25           | 0.10  | 1.50           | 1.50           | 8.00           | 2.00           | 4.00           | 12.00 | 1.75  | 5.50  |

Kunde / customer :

Artikelnummer / part number : **82 306 050 029**

Bezeichnung :

description : **0603 ESD ULTRA LOW CAP TVS**

SMD size: **0603**

**D Rollenspezifikation / tape and reel specification :**

(Unit : mm)

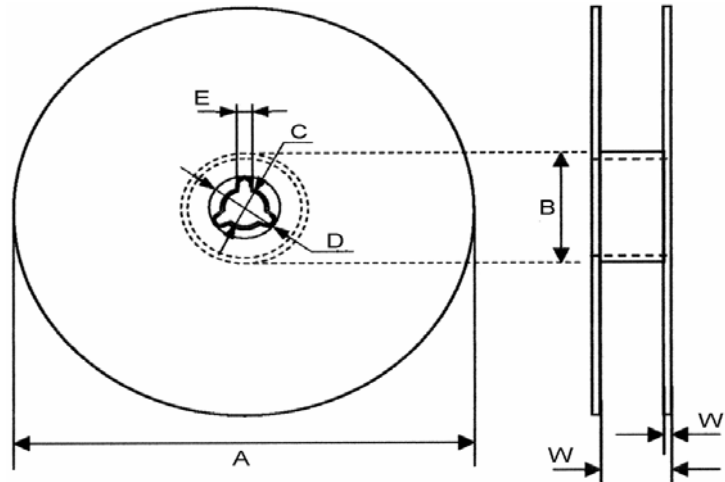

REEL DIMENSION

(Unit : mm)

| Symbol      | A         | B        | C        | D        | E       | W        | W <sub>1</sub> |
|-------------|-----------|----------|----------|----------|---------|----------|----------------|
| <b>402</b>  | 178.0±1.0 | 60.0±0.5 | 13.0±0.2 | 21.0±0.2 | 2.0±0.5 | 9.0±0.50 | 1.5±0.15       |
| <b>603</b>  | 178.0±1.0 | 60.0±0.5 | 13.0±0.2 | 21.0±0.2 | 2.0±0.5 | 9.0±0.50 | 1.5±0.15       |
| <b>805</b>  | 178.0±1.0 | 60.0±0.5 | 13.0±0.2 | 21.0±0.2 | 2.0±0.5 | 9.0±0.50 | 1.5±0.15       |
| <b>1206</b> | 178.0±1.0 | 60.0±0.5 | 13.0±0.2 | 21.0±0.2 | 2.0±0.5 | 9.0±0.50 | 1.5±0.15       |
| <b>1210</b> | 178.0±1.0 | 60.0±0.5 | 13.0±0.2 | 21.0±0.2 | 2.0±0.5 | 9.0±0.50 | 1.5±0.15       |
| <b>1812</b> | 178.0±1.0 | 60.0±0.5 | 13.5±0.1 | 21.0±0.2 | 2.0±0.5 | 13.6±0.2 | 1.5±0.15       |
| <b>2220</b> | 178.0±1.0 | 60.0±0.5 | 13.5±0.1 | 21.0±0.2 | 2.0±0.5 | 13.6±0.2 | 1.5±0.15       |

\* 2.0 mm for 361 and 391

\* 2.5 mm for 431 and 471

QUANTITY PER PACKING UNIT

| Type            | 402    | 603   | 805   | 1206  | 1210  | 1812  | 2220  |
|-----------------|--------|-------|-------|-------|-------|-------|-------|
| <b>Pcs/reel</b> | 10 000 | 5 000 | 3 000 | 3 000 | 2 000 | 1 000 | 1 000 |

Kunde / customer :

Artikelnummer / part number : **82 306 050 029**

Bezeichnung :

description : **0603 ESD ULTRA LOW CAP TVS**

SMD size: **0603**

**E Testbedingungen / test conditions :**

BASIC TEST

| Characteristics          | Test Method/Description  |
|--------------------------|--|
| Standard Test Condition  | Environmental condition under which every measuring is done without doubt on the measuring results. Unless specially specified, temperature, relative humidity are 5 to 35°C, 45 to 85 % RH. |
| Max. Working Voltage     | Maximum steady-state DC operating voltage the device can maintain and typical leakage current at 25°C not exceed 50 µA.  |
| Varistor Voltage         | With the specified measuring current of 1mA DC applied.  |
| Max. Clamping Voltage    | Maximum peak voltage across the TVS measured at a specified pulse current (A) and waveform 8/20µs.   |
| Surge Current            | Maximum peak current which may be applied with the specified waveform 8/20µs without device failure.   |
| Surge Shift $\Delta V/V$ | The shift of TVS voltage after suffering the specified surge current.  |
| Energy Absorption        | Maximum energy which may be dissipated with a specified waveform 10/1000µs without device failure.   |
| Typical Capacitance      | Device Capacitance measured with zero voltage bias 0.5VRMS and 1KHZ  |
| Leakage Current          | Typical leakage current at 25°C < 50µA   |

ENVIRONMENTAL RELIABILITY TEST

| Characteristic               | Test method and description  |           |             |        |   |         |         |  |      |  |   |             |           |   |         |         |   |             |           |
|------------------------------|--|-----------|-------------|--------|---|---------|---------|--|------|--|---|-------------|-----------|---|---------|---------|---|-------------|-----------|
| High Temperature Storage     | The specimen shall be subjected to 150 ± 2°C for 1000 ± 12 hours in a thermostatic bath without load and then stored at room temperature and humidity for 1 to 2 hours. The change of varistor voltage shall be within 10 %.   |           |             |        |   |         |         |  |      |  |   |             |           |   |         |         |   |             |           |
| Temperature Cycle            | The temperature cycle of specified temperature shall be repeated five times and then stored at room temperature and humidity for one or two hours. the change of varistor voltage shall be within 10 % and mechanical damage shall be examined.  |           |             |        |   |         |         |  |      |  |   |             |           |   |         |         |   |             |           |
|                              | <table border="1"> <thead> <tr> <th>Step</th> <th>Temperature</th> <th>Period</th> </tr> </thead> <tbody> <tr> <td>1</td> <td>-40±3°C</td> <td>30Min±3</td> </tr> <tr> <td></td> <td>Room</td> <td></td> </tr> <tr> <td>2</td> <td>Temperature</td> <td>1~2 hours</td> </tr> <tr> <td>3</td> <td>125±2°C</td> <td>30Min±3</td> </tr> <tr> <td>4</td> <td>Temperature</td> <td>1~2 hours</td> </tr> </tbody> </table> | Step      | Temperature | Period | 1 | -40±3°C | 30Min±3 |  | Room |  | 2 | Temperature | 1~2 hours | 3 | 125±2°C | 30Min±3 | 4 | Temperature | 1~2 hours |
| Step                         | Temperature  | Period    |             |        |   |         |         |  |      |  |   |             |           |   |         |         |   |             |           |
| 1                            | -40±3°C  | 30Min±3   |             |        |   |         |         |  |      |  |   |             |           |   |         |         |   |             |           |
|                              | Room   |           |             |        |   |         |         |  |      |  |   |             |           |   |         |         |   |             |           |
| 2                            | Temperature  | 1~2 hours |             |        |   |         |         |  |      |  |   |             |           |   |         |         |   |             |           |
| 3                            | 125±2°C  | 30Min±3   |             |        |   |         |         |  |      |  |   |             |           |   |         |         |   |             |           |
| 4                            | Temperature  | 1~2 hours |             |        |   |         |         |  |      |  |   |             |           |   |         |         |   |             |           |
| High Temperature Load        | After being continuously applied the maximum allowable voltage at 85 ± 2°C for 1000± 2 hours, the specimen shall be stored at room temperature and humidity for one or two hours, the change of varistor voltage shall be within 10 %.   |           |             |        |   |         |         |  |      |  |   |             |           |   |         |         |   |             |           |
| Damp Heat Load/Humidity Load | The specimen should be subjected to 40 ± 2°C, 90 to 95 % RH environment , and the maximum allowable voltage applied for 1000 hours, then stored at room temperature and humidity for one or two hours. the change of varistor voltage shall be within 10 %   |           |             |        |   |         |         |  |      |  |   |             |           |   |         |         |   |             |           |
| Low Temperature Storage      | The specimen should be subjected to 40 ± 2°C, without load for 1000 hours and then stored at room temperature for one or two hours. the change of varistor voltage shall be within 10 %  |           |             |        |   |         |         |  |      |  |   |             |           |   |         |         |   |             |           |

|  |                          |                         |                         |              |
|--|--------------------------|-------------------------|-------------------------|--------------|
| Freigabe erteilt /<br>general release: | <b>Kunde / customer</b>  |                         |                         |              |
| Datum / date                           | Unterschrift / signature | JP. PENLOU              | High Temperature Load   | 06-07-31     |
|  | <b>Würth Elektronik</b>  | JP. PENLOU              | New P/N                 | 2006-06-02   |
|  |                          | JP. PENLOU              | Operating temp. Range   | 2005-11-30   |
|  |                          | JP. PENLOU              | Lead free soldering     | 2005-11-04   |
| Geprüft / checked                      | 2006-07-31               | Kontrolliert / approved | JP. Penlou              |              |
|  |                          | Name                    | Änderung / modification | Datum / date |

## Данный компонент на территории Российской Федерации

### Вы можете приобрести в компании MosChip.

Для оперативного оформления запроса Вам необходимо перейти по данной ссылке:

<http://moschip.ru/get-element>

Вы можете разместить у нас заказ для любого Вашего проекта, будь то серийное производство или разработка единичного прибора.

В нашем ассортименте представлены ведущие мировые производители активных и пассивных электронных компонентов.

Нашей специализацией является поставка электронной компонентной базы двойного назначения, продукции таких производителей как XILINX, Intel (ex.ALTERA), Vicor, Microchip, Texas Instruments, Analog Devices, Mini-Circuits, Amphenol, Glenair.

Сотрудничество с глобальными дистрибьюторами электронных компонентов, предоставляет возможность заказывать и получать с международных складов практически любой перечень компонентов в оптимальные для Вас сроки.

На всех этапах разработки и производства наши партнеры могут получить квалифицированную поддержку опытных инженеров.

Система менеджмента качества компании отвечает требованиям в соответствии с ГОСТ Р ИСО 9001, ГОСТ РВ 0015-002 и ЭС РД 009

### Офис по работе с юридическими лицами:

105318, г.Москва, ул.Щербаковская д.3, офис 1107, 1118, ДЦ «Щербаковский»

Телефон: +7 495 668-12-70 (многоканальный)

Факс: +7 495 668-12-70 (доб.304)

E-mail: [info@moschip.ru](mailto:info@moschip.ru)

Skype отдела продаж:

moschip.ru

moschip.ru\_4

moschip.ru\_6

moschip.ru\_9