

ISL71444M

19MHz 40V Quad Rail-to-Rail Input-Output, Low-Power Operational Amplifier

FN8892
Rev.2.00
Aug 16, 2019

The [ISL71444M](#) features four radiation tolerant, low-power amplifiers optimized to provide maximum dynamic range. These op amps feature a unique combination of rail-to-rail operation on the input and output as well as a slew enhanced front-end that provides ultra fast slew rates positively proportional to a given step size. They also offer low-power, low-offset voltage, and low temperature drift, making the ISL71444M ideal for applications requiring both high DC accuracy and AC performance.

Related Literature

For a full list of related documents, visit our website:

- [ISL71444M](#) device page

Features

- Passes NASA Low Outgassing specifications
- Unity gain stable with wide gain-bandwidth product: 19MHz
- Wide single and dual supply range: 2.7V to 40V maximum
- Low input offset voltage: 400µV
- Low current consumption (per amplifier): 1.1mA, typical
- High large signal slew rate: 60V/µs
- Operating temperature range: -55°C to +125°C
- 14 Ld TSSOP with NiPdAu lead finish
- Characterized radiation level
 - Low Dose Rate (<10mrad(Si)): 30krad(Si)
 - Single Event Effects (LET): 43 MeV•cm²/mg

Applications

- Low Earth Orbit (LEO) applications
- High altitude avionics
- Precision instruments
- Data acquisition
- Power supply control

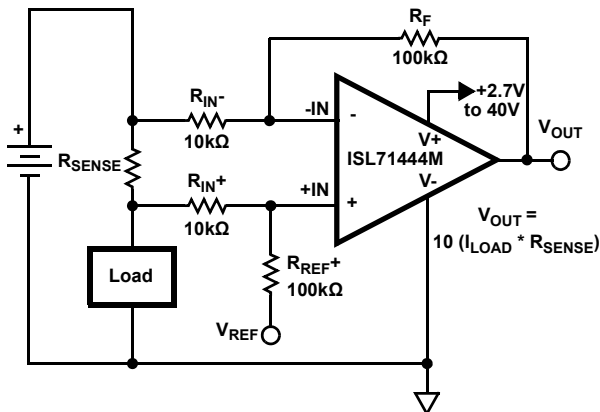

Figure 1. Typical Application: Single-Supply, High-Side Current Sense Amplifier

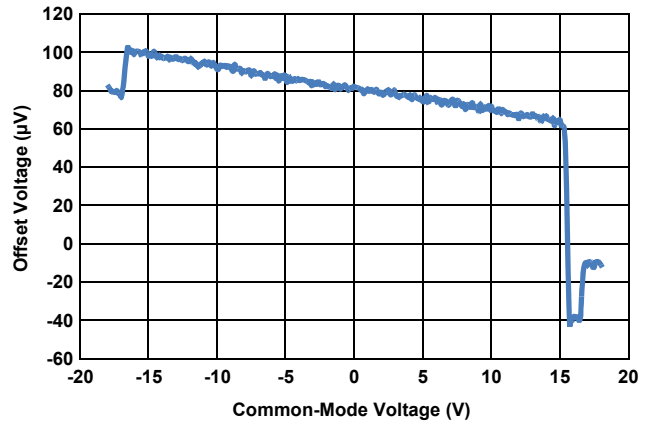

Figure 2. Offset Voltage vs Common-Mode Voltage

Contents

1. Overview	3
1.1 Ordering Information	3
1.2 Pin Configuration	3
1.3 Pin Descriptions	4
2. Specifications	5
2.1 Absolute Maximum Ratings	5
2.2 Outgas Testing	5
2.3 Thermal Information	5
2.4 Recommended Operation Conditions	5
2.5 Electrical Specifications	6
3. Typical Performance Curves	9
4. Applications Information	17
4.1 Functional Description	17
4.2 Operating Voltage Range	17
4.3 Input Performance	17
4.4 Input ESD Diode Protection	17
4.5 Output Short-Circuit Current Limiting	17
4.6 Output Phase Reversal	18
4.7 Power Dissipation	18
4.8 Slew Rate Enhancement	18
4.9 Unused Channel Configuration	19
5. Radiation Tolerance	20
5.1 Total Ionizing Dose (TID) Testing	20
5.2 Single Event Effects Testing	25
6. Revision History	27
7. Package Outline Drawing	28

1. Overview

1.1 Ordering Information

Part Number (Notes 2, 3)	Part Marking	Temp Range (°C)	Tape and Reel (Units)	Package (RoHS Compliant)	Pkg. Dwg. #
ISL71444MVZ	71444 MVZ	-55 to +125	-	14 Ld TSSOP	M14.173
ISL71444MVZ-T (Note 1)	71444 MVZ	-55 to +125	2.5k	14 Ld TSSOP	M14.173
ISL71444MVZ-T7A (Note 1)	71444 MVZ	-55 to +125	250	14 Ld TSSOP	M14.173
ISL71444MEVAL1Z	Evaluation Board				

Notes:

- See [TB347](#) for details about reel specifications.
- These Pb-free plastic packaged products employ special Pb-free material sets; molding compounds/die attach materials and NiPdAu-Ag plate - e4 termination finish, which is RoHS compliant and compatible with both SnPb and Pb-free soldering operations. Pb-free products are MSL classified at Pb-free peak reflow temperatures that meet or exceed the Pb-free requirements of IPC/JEDEC J STD-020.
- For Moisture Sensitivity Level (MSL), see the [ISL71444M](#) device page. For more information about MSL, see [TB363](#).

1.2 Pin Configuration

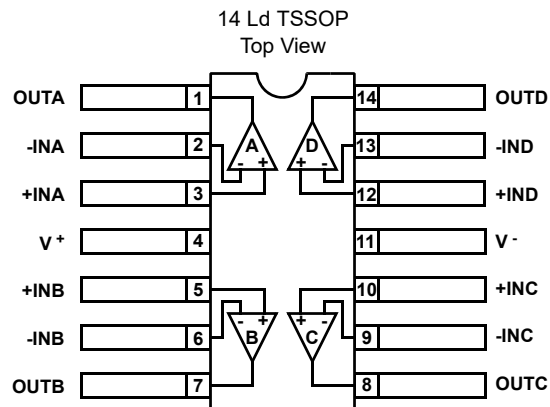

1.3 Pin Descriptions

Pin Number	Pin Name	Equivalent ESD Circuit	Description
1	OUTA	Circuit 2	Amplifier A output
2	-INA	Circuit 1	Amplifier A inverting input
3	+INA	Circuit 1	Amplifier A non-inverting input
4	V ⁺	Circuit 3	Positive power supply
5	+INB	Circuit 1	Amplifier B non-inverting input
6	-INB	Circuit 1	Amplifier B inverting input
7	OUTB	Circuit 2	Amplifier B output
8	OUTC	Circuit 2	Amplifier C output
9	-INC	Circuit 1	Amplifier C inverting input
10	+INC	Circuit 1	Amplifier C non-inverting input
11	V ⁻	Circuit 3	Negative power supply
12	+IND	Circuit 1	Amplifier D non-inverting input
13	-IND	Circuit 1	Amplifier D inverting input
14	OUTD	Circuit 2	Amplifier D output

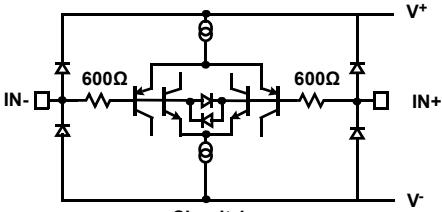

Circuit 1

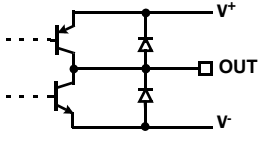

Circuit 2

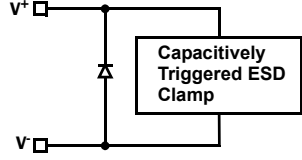

Circuit 3

2. Specifications

2.1 Absolute Maximum Ratings

Parameter	Minimum	Maximum	Unit
Maximum Supply Voltage		42	V
Maximum Differential Input Current		20	mA
Maximum Differential Input Voltage	42 or $V^- - 0.5$	$V^+ + 0.5$	V
Min/Max Input Voltage	42 or $V^- - 0.5$	$V^+ + 0.5$	V
Max/Min Input Current for Input Voltage $>V^+$ or $<V^-$		± 20	mA
ESD Rating		Value	Unit
Human Body Model (Tested per JS-001-2014)		7	kV
Machine Model (Tested per JESD22-A115C)		400	V
Charged Device Model (Tested per JS-002-2014)		2	kV
Latch-Up (Tested per JESD78E; Class 2, Level A), at +125°C		100	mA

CAUTION: Do not operate at or near the maximum ratings listed for extended periods of time. Exposure to such conditions may adversely impact product reliability and result in failures not covered by warranty.

2.2 Outgas Testing

Specification (Tested per ASTM E 595, 1.5)	Value	Unit
Total Mass Lost (Note 4)	0.06	%
Collected Volatile Condensable Material (Note 4)	<0.01	%
Water Vapor Recovered	0.03	%

Note:

4. Outgassing results meet NASA requirements of Total Mass Lost <1% and Collected Volatile Condensable Material of <0.1%.

2.3 Thermal Information

Thermal Resistance (Typical)	θ_{JA} (°C/W)	θ_{JC} (°C/W)
14 Ld TSSOP Package (Notes 5, 6)	92	30

Notes:

5. θ_{JA} is measured in free air with the component mounted on a high-effective thermal conductivity test board. See [TB379](#).

6. For θ_{JC} , the "case temp" location is the top center.

Parameter	Minimum	Maximum	Unit
Storage Temperature Range	-65	+150	°C
Pb-Free Reflow Profile	see TB493		

2.4 Recommended Operation Conditions

Parameter	Minimum	Maximum	Unit
Ambient Operating Temperature Range	-55	+125	°C
Maximum Operating Junction Temperature		+150	°C
Single Supply Voltage	3 $\pm 10\%$	36 $\pm 10\%$	V
Split Rail Supply Voltage	$\pm 1.5 \pm 10\%$	$\pm 18 \pm 10\%$	V

2.5 Electrical Specifications

2.5.1 $V_S = \pm 18V$

$V_{CM} = V_O = 0V$, $R_L = \text{Open}$, $T_A = +25^\circ\text{C}$, unless otherwise noted. **Boldface limits apply across the operating temperature range, -55°C to $+125^\circ\text{C}$.**

Parameter	Symbol	Test Conditions	Min (Note 7)	Typ	Max (Note 7)	Unit
Offset Voltage	V_{OS}	$V_{CM} = 0V$	-400	100	400	μV
		$V_{CM} = V^+$ to V^-	-500	130	500	μV
Offset Voltage Temperature Coefficient	TCV_{OS}	$V_{CM} = V^+ - 2V$ to $V^- + 2V$	-	0.5	-	$\mu\text{V}/^\circ\text{C}$
Input Offset Channel-to-Channel Match	ΔV_{OS}	$V_{CM} = V^+$	-800	150	800	μV
		$V_{CM} = V^-$	-800	170	800	μV
Input Bias Current	I_B	$V_{CM} = 0V$	-	200	500	nA
		$V_{CM} = V^+$	-	174	500	nA
		$V_{CM} = V^-$	-	268	650	nA
		$V_{CM} = V^+ - 0.5V$	-	174	500	nA
		$V_{CM} = V^- + 0.5V$	-	268	650	nA
Input Offset Current	I_{OS}	$V_{CM} = V^+$ to V^-	-30	3	30	nA
			-50	-	50	nA
Common-Mode Input Voltage Range	V_{CMIR}		V-	-	V+	V
Common-Mode Rejection Ratio	CMRR	$V_{CM} = V^-$ to V^+	70	113	-	dB
		$V_{CM} = V^+ - 0.5V$ to $V^- + 0.5V$	80	113	-	dB
Power Supply Rejection Ratio	PSRR	$V^- = -18V$; $V^+ = 0.5V$ to $18V$ $V^+ = 18V$; $V^- = -0.5V$ to $-18V$	83	130	-	dB
Open-Loop Gain	A_{VOL}	$R_L = 10k\Omega$ to ground	90	130	-	dB
Output Voltage High (V_{OUT} to V^+)	V_{OH}	$R_L = \text{No load}$	-	25	160	mV
		$R_L = 10k\Omega$	-	75	175	mV
Output Voltage Low (V_{OUT} to V^-)	V_{OL}	$R_L = \text{No load}$	-	22	160	mV
		$R_L = 10k\Omega$	-	65	175	mV
Output Short-Circuit Current	I_{SRC}	Sourcing; $V_{IN} = 0V$, $V_{OUT} = -18V$	10	56	-	mA
Output Short-Circuit Current	I_{SNK}	Sinking; $V_{IN} = 0V$, $V_{OUT} = +18V$	10	56	-	mA
Supply Current/Amplifier	I_S	Unity gain	-	1.5	2.8	mA
AC Specifications						
Gain-Bandwidth Product	GBW	$A_{CL} = 101$, $R_L = 10k$	-	19	-	MHz
Voltage Noise Density	e_n	$f = 10kHz$	-	11.3	-	$\text{nV}/\sqrt{\text{Hz}}$
Current Noise Density	i_n	$f = 10kHz$	-	0.312	-	$\text{pA}/\sqrt{\text{Hz}}$
Large Signal Slew Rate	SR	$A_V = 1$, $R_L = 10k\Omega$, $V_O = 10V_{P-P}$	60	180	-	$\text{V}/\mu\text{s}$

2.5.2 $V_S = \pm 2.5V$

$V_{CM} = V_O = 0V$, $R_L = \text{Open}$, $T_A = +25^\circ\text{C}$, unless otherwise noted. **Boldface limits apply across the operating temperature range, -55°C to $+125^\circ\text{C}$.**

Description	Parameter	Test Conditions	Min (Note 7)	Typ	Max (Note 7)	Unit
Offset Voltage	V_{OS}	$V_{CM} = 0V$	-400	100	400	μV
		$V_{CM} = V^+$ to V^-	500	130	500	μV
Offset Voltage Temperature Coefficient	TCV_{OS}	$V_{CM} = V^+ - 2V$ to $V^- + 2V$	-	0.5	-	$\mu\text{V}/^\circ\text{C}$
Input Offset Channel-to-Channel Match	ΔV_{OS}	$V_{CM} = V^+$	-800	150	800	μV
		$V_{CM} = V^-$	-800	180	800	μV
Input Bias Current	I_B	$V_{CM} = 0V$	-	211	400	nA
		$V_{CM} = V^+$	-	157	400	nA
		$V_{CM} = V^-$	-	235	580	nA
		$V_{CM} = V^+ - 0.5V$	-	157	400	nA
		$V_{CM} = V^- + 0.5V$	-	235	580	nA
Input Offset Current	I_{OS}	$V_{CM} = V^+$ to V^-	-30	3	30	nA
			-50	-	50	nA
Common-Mode Input Voltage Range	V_{CMIR}		V-	-	V+	V
Common-Mode Rejection Ratio	CMRR	$V_{CM} = V^-$ to V^+	70	95	-	dB
		$V_{CM} = V^+ - 0.5V$ to $V^- + 0.5V$	74	93	-	dB
Power Supply Rejection Ratio	PSRR	$V^- = -2.5V$; $V^+ = 0.5V$ to $2.5V$ $V^+ = 2.5V$; $V^- = -0.5V$ to $-2.5V$ $T_A = 25^\circ\text{C}, 125^\circ\text{C}$	80	125	-	dB
		$V^- = -2.5V$; $V^+ = 0.5V$ to $2.5V$ $V^+ = 2.5V$; $V^- = -0.5V$ to $-2.5V$ $T_A = -55^\circ\text{C}$	70	97	-	dB
Open-Loop Gain	A_{VOL}	$R_L = 10\text{k}\Omega$ to ground	90	120	-	dB
Output Voltage High (V_{OUT} to V^+)	V_{OH}	$R_L = \text{No load}$	-	14	85	mV
		$R_L = 10\text{k}\Omega$	-	23	105	mV
		$R_L = 600\Omega$	-	230	400	mV
Output Voltage Low (V_{OUT} to V^-)	V_{OL}	$R_L = \text{No load}$	-	10	85	mV
		$R_L = 10\text{k}\Omega$	-	18	105	mV
		$R_L = 600\Omega$	-	200	400	mV
Supply Current/Amplifier	I_S	Unity gain	-	1.1	2.0	mA
AC Specifications						
Gain-Bandwidth Product	GBW	$A_{CL} = 101$, $R_L = 10\text{k}$	-	17	-	MHz
Voltage Noise Density	e_n	$f = 10\text{kHz}$	-	12.3	-	$\text{nV}/\sqrt{\text{Hz}}$
Current Noise Density	i_n	$f = 10\text{kHz}$	-	0.313	-	$\text{pA}/\sqrt{\text{Hz}}$
Large Signal Slew Rate	SR	$A_V = 1$, $R_L = 10\text{k}\Omega$, $V_O = 3V_{P-P}$	-	60	-	$\text{V}/\mu\text{s}$

2.5.3 $V_S = \pm 1.5V$

$V_{CM} = V_O = 0V$, $R_L = \text{Open}$, $T_A = +25^\circ\text{C}$, unless otherwise noted. **Boldface limits apply across the operating temperature range, -55°C to $+125^\circ\text{C}$.**

Description	Parameter	Test Conditions	Min (Note 7)	Typ	Max (Note 7)	Unit
Offset Voltage	V_{OS}	$V_{CM} = 0V$	-400	100	400	μV
		$V_{CM} = V^+$ to V^-	-500	130	500	μV
Input Offset Channel-to-Channel Match	ΔV_{OS}	$V_{CM} = V^+$	-800	150	800	μV
		$V_{CM} = V^-$	-800	180	800	μV
Input Bias Current	I_B	$V_{CM} = 0V$	-	176	375	nA
		$V_{CM} = V^+$	-	155	375	nA
		$V_{CM} = V^-$	-	232	565	nA
		$V_{CM} = V^+ - 0.5V$	-	155	375	nA
		$V_{CM} = V^- + 0.5V$	-	232	565	nA
Input Offset Current	I_{OS}	$V_{CM} = V^+$ to V^-	-30	3	30	nA
			-50	-	50	nA
Common-Mode Input Voltage Range	V_{CMIR}		V-	-	V+	V
Output Voltage High (V_{OUT} to V^+)	V_{OH}	$R_L = \text{No load}$	-	19	50	mV
		$R_L = 10k\Omega$	-	19	70	mV
Output Voltage Low (V_{OUT} to V^-)	V_{OL}	$R_L = \text{No load}$	-	14	50	mV
		$R_L = 10k\Omega$	-	14	70	mV
Supply Current/Amplifier	I_S	Unity Gain	-	1.1	2.0	mA
AC Specifications						
Gain-Bandwidth Product	GBW	$A_{CL} = 101$, $R_L = 10k$	-	16	-	MHz
Voltage Noise Density	e_n	$f = 10\text{kHz}$	-	12	-	$\text{nV}/\sqrt{\text{Hz}}$
Current Noise Density	i_n	$f = 10\text{kHz}$	-	0.312	-	$\text{pA}/\sqrt{\text{Hz}}$

Note:

7. Compliance to datasheet limits is assured by one or more methods: production test, characterization, and/or design.

3. Typical Performance Curves

Unless otherwise specified, $V_S \pm 18V$, $V_{CM} = 0$, $V_O = 0V$, $T_A = +25^\circ C$.

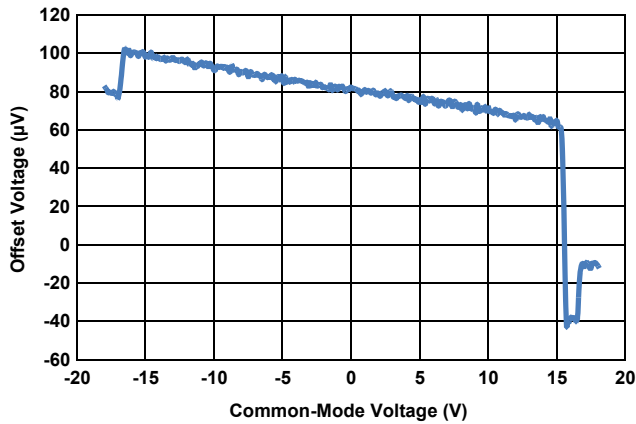

Figure 3. Offset Voltage vs Common-Mode Voltage

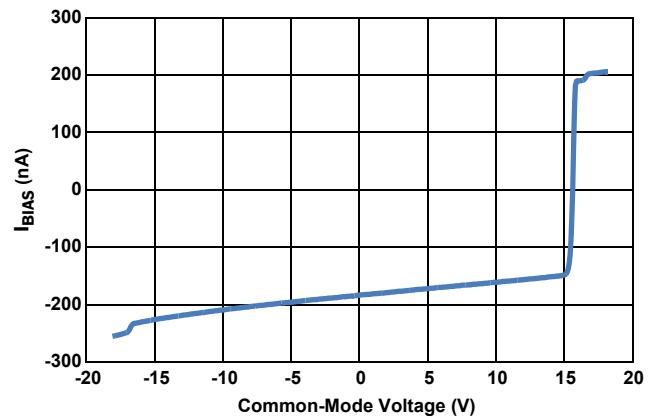

Figure 4. I_{BIAS} vs Common-Mode Voltage

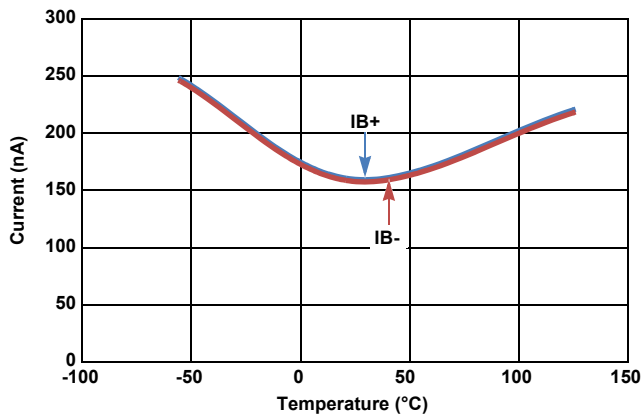

Figure 5. I_{BIAS} vs Temperature ($V_S = \pm 18V$)

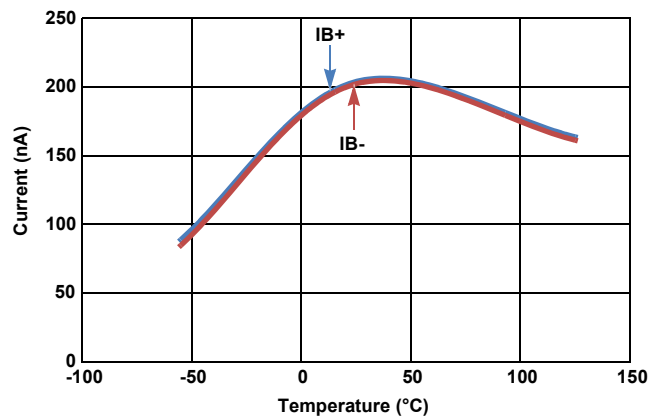

Figure 6. I_{BIAS} vs Temperature ($V_S = \pm 2.5V$)

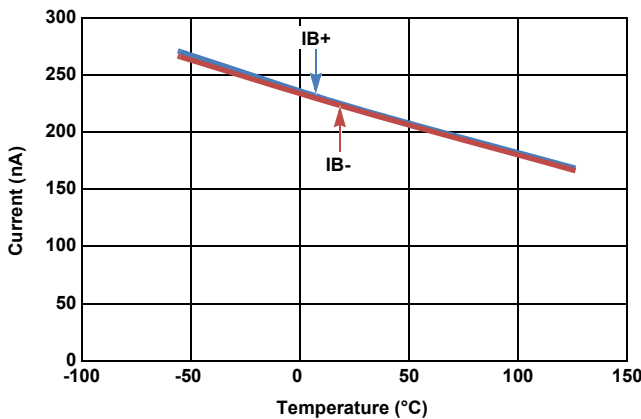

Figure 7. I_{BIAS} vs Temperature ($V_S = \pm 1.5V$)

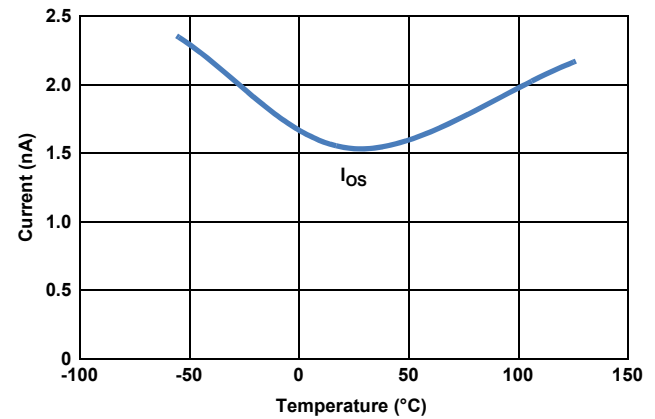

Figure 8. I_{OS} vs Temperature ($V_S = \pm 18V$)

Unless otherwise specified, $V_S \pm 18V$, $V_{CM} = 0$, $V_O = 0V$, $T_A = +25^\circ C$. (Continued)

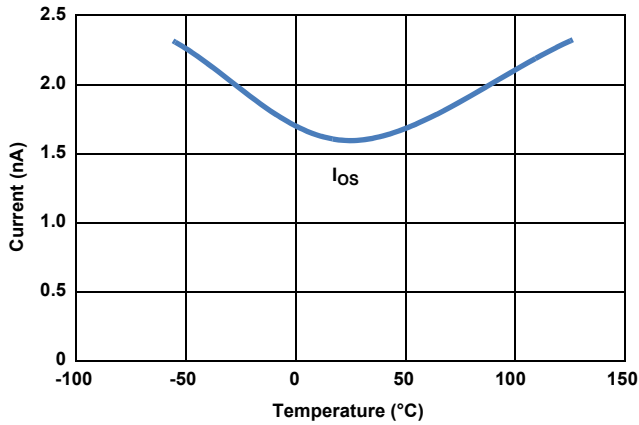

Figure 9. I_{OS} vs Temperature ($V_S = \pm 2.5V$)

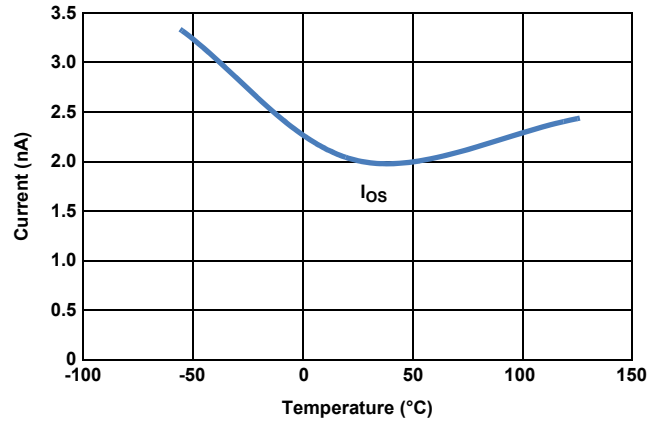

Figure 10. I_{OS} vs Temperature ($V_S = \pm 1.5V$)

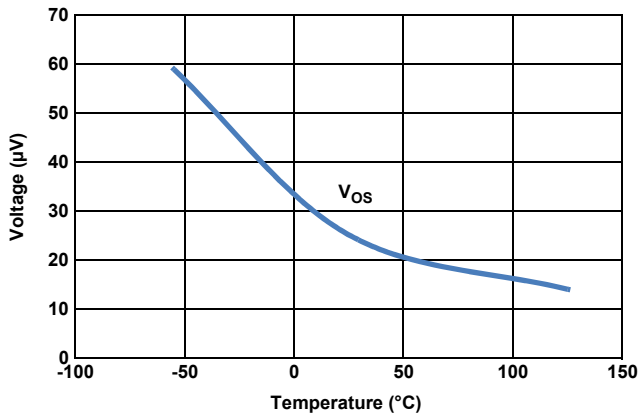

Figure 11. V_{OS} vs Temperature ($V_S = \pm 18V$)

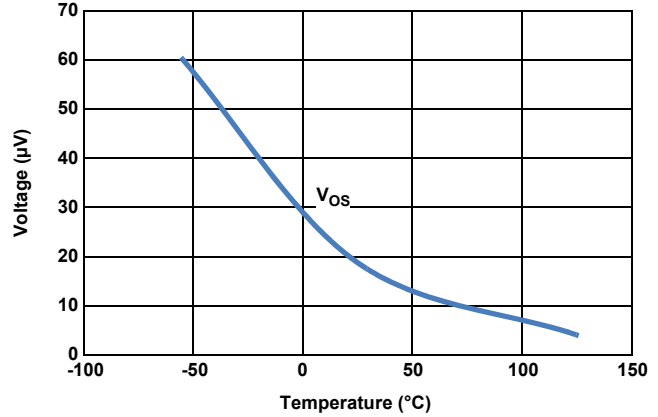

Figure 12. V_{OS} vs Temperature ($V_S = \pm 2.5V$)

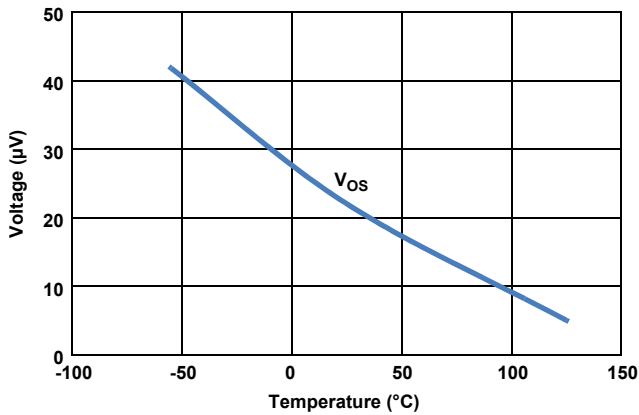

Figure 13. V_{OS} vs Temperature ($V_S = \pm 1.5V$)

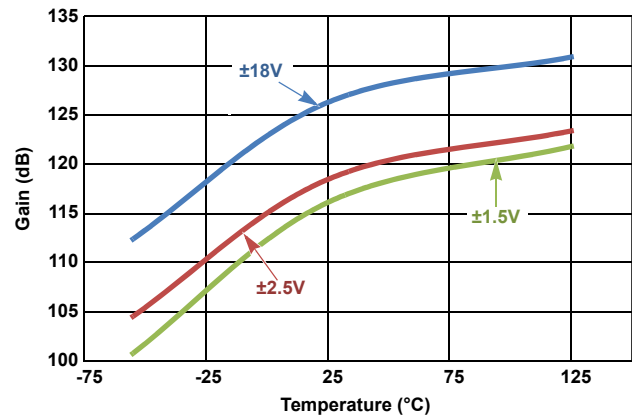

Figure 14. A_{VOL} vs Temperature vs Supply Voltage

Unless otherwise specified, $V_S \pm 18V$, $V_{CM} = 0$, $V_O = 0V$, $T_A = +25^\circ C$. (Continued)

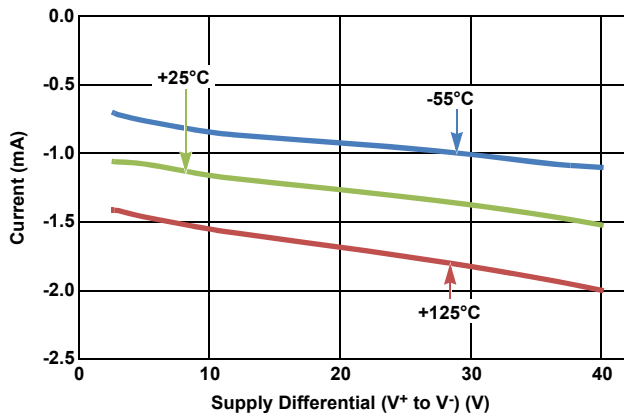

Figure 15. Negative Supply Current vs Supply Voltage

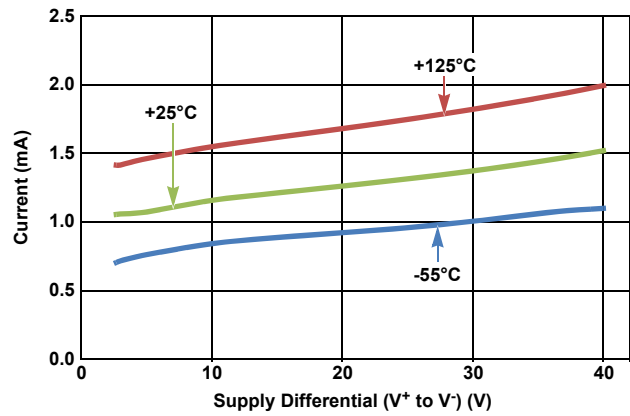

Figure 16. Positive Supply Current vs Supply Voltage

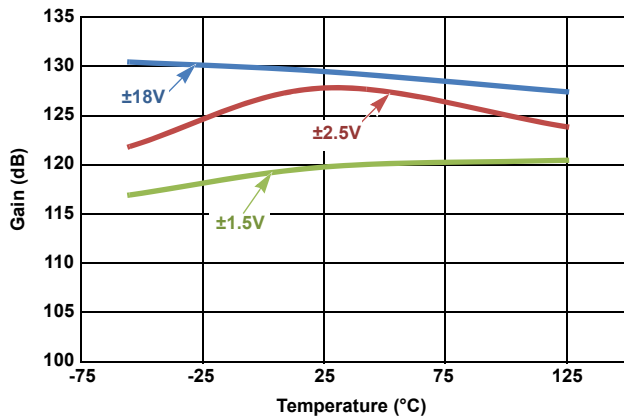

Figure 17. PSRR+ vs Temperature vs Supply Voltage

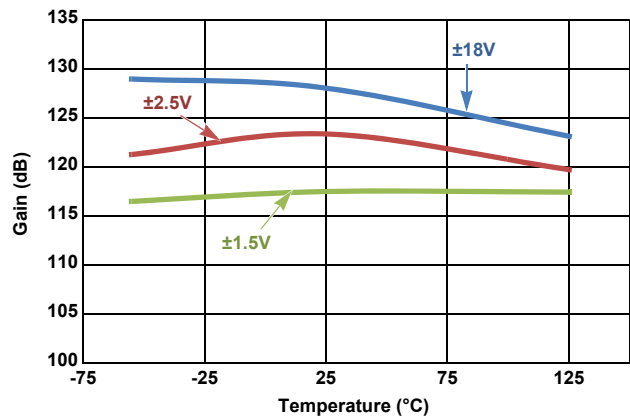

Figure 18. PSRR- vs Temperature vs Supply Voltage

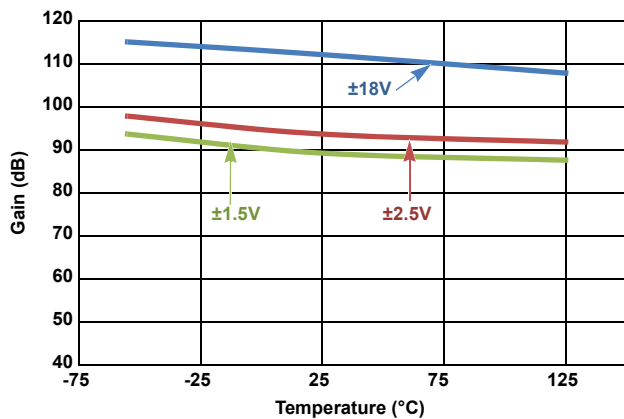

Figure 19. CMRR vs Temperature vs Supply Voltage

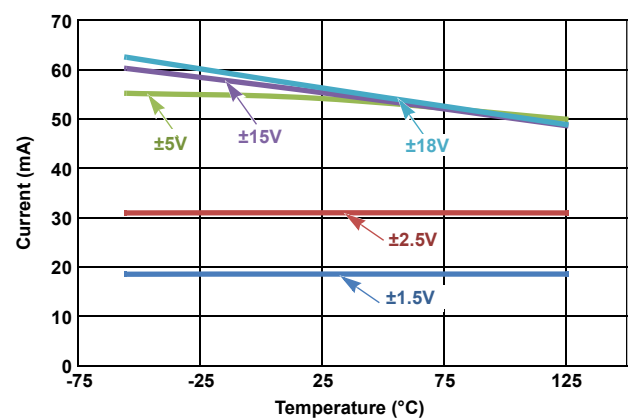

Figure 20. Short-Circuit Current vs Temperature

Unless otherwise specified, $V_S \pm 18V$, $V_{CM} = 0$, $V_O = 0V$, $T_A = +25^\circ C$. (Continued)

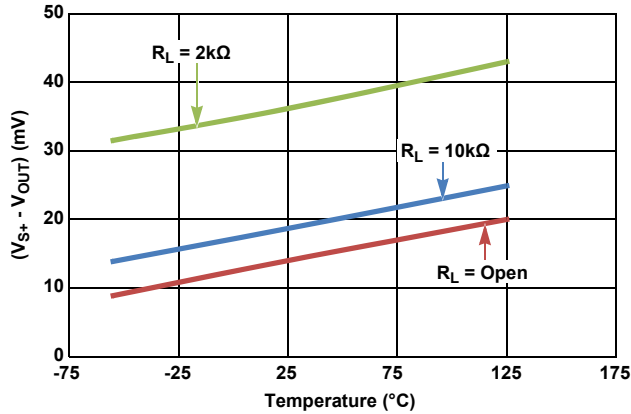

Figure 21. ($V_S = \pm 1.5V$) V_{OH} vs Temperature

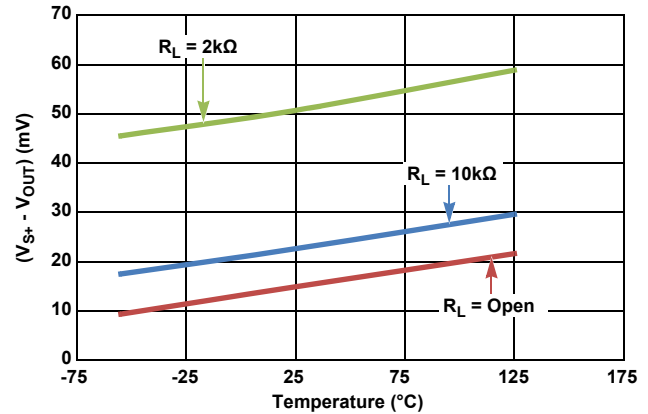

Figure 22. ($V_S = \pm 2.5V$) V_{OH} vs Temperature

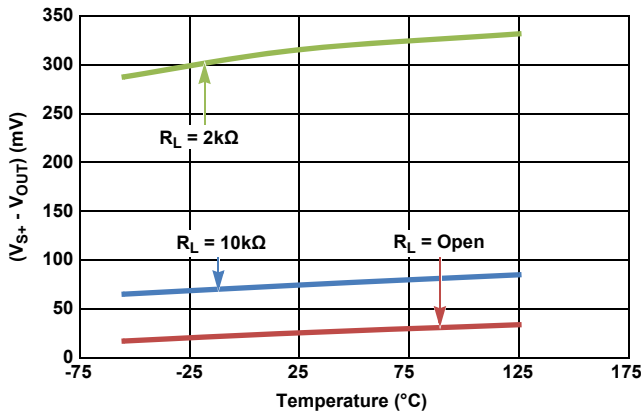

Figure 23. ($V_S = \pm 18V$) V_{OH} vs Temperature

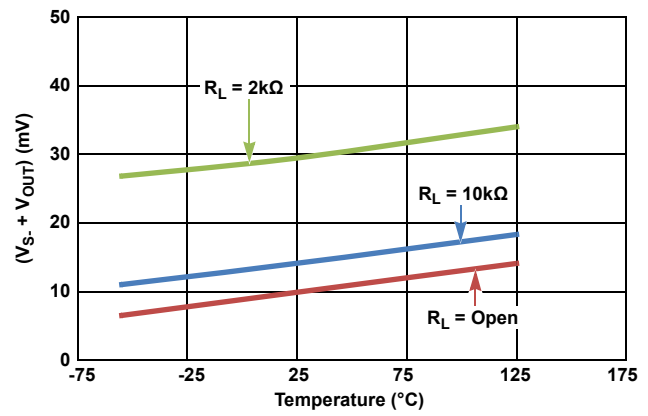

Figure 24. ($V_S = \pm 1.5V$) V_{OL} vs Temperature

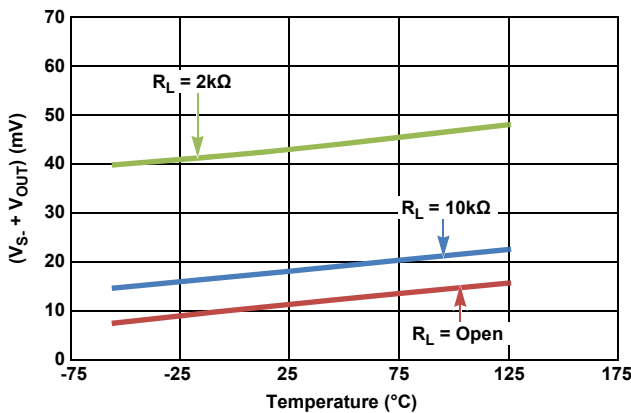

Figure 25. ($V_S = \pm 2.5V$) V_{OL} vs Temperature

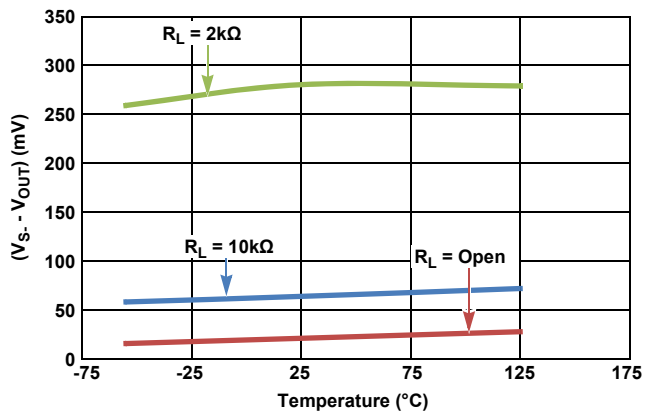

Figure 26. ($V_S = \pm 18V$) V_{OL} vs Temperature

Unless otherwise specified, $V_S \pm 18V$, $V_{CM} = 0$, $V_O = 0V$, $T_A = +25^\circ C$. (Continued)

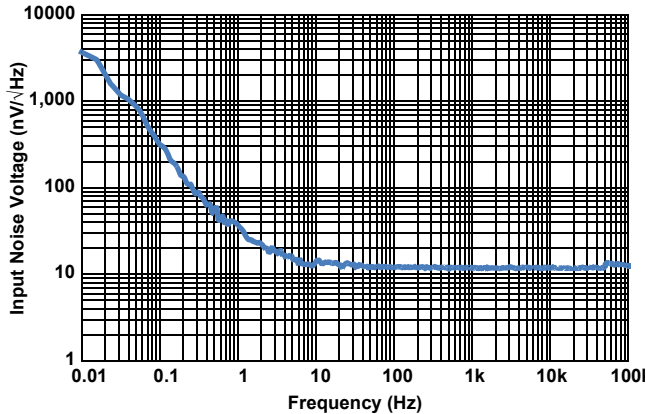

Figure 27. Input Noise Voltage Spectral Density ($V_S = \pm 18V$)

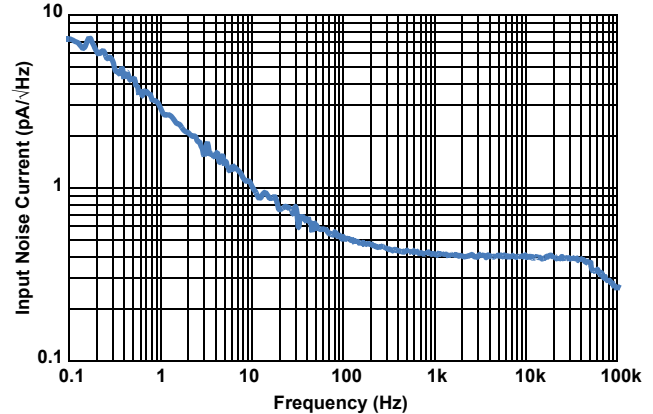

Figure 28. Input Noise Current Spectral Density ($V_S = \pm 18V$)

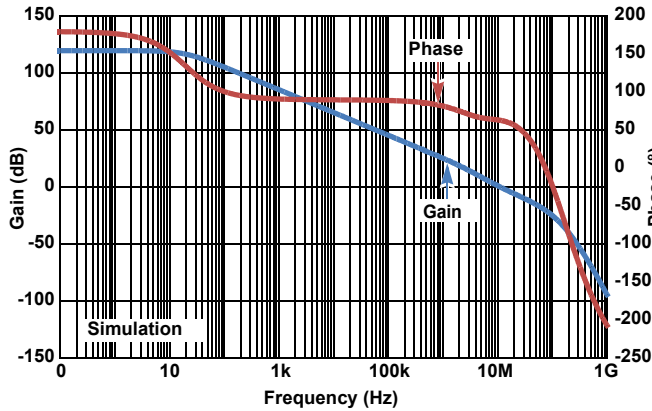

Figure 29. Open-Loop Frequency Response ($C_L = 0.01pF$)

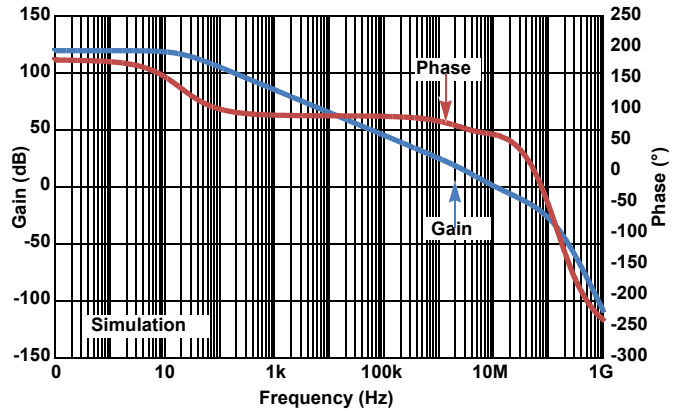

Figure 30. Open-Loop Frequency Response ($C_L = 10pF$)

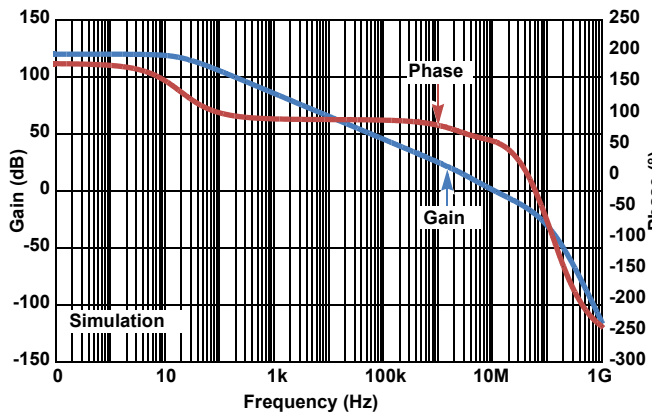

Figure 31. Open-Loop Frequency Response ($C_L = 22pF$)

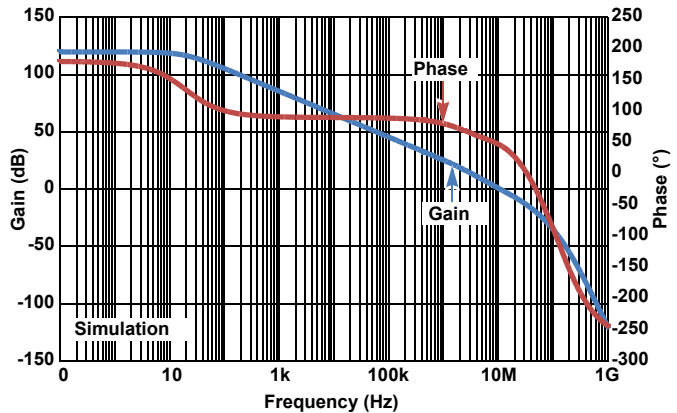

Figure 32. Open-Loop Frequency Response ($C_L = 47pF$)

Unless otherwise specified, $V_S \pm 18V$, $V_{CM} = 0$, $V_O = 0V$, $T_A = +25^\circ C$. (Continued)

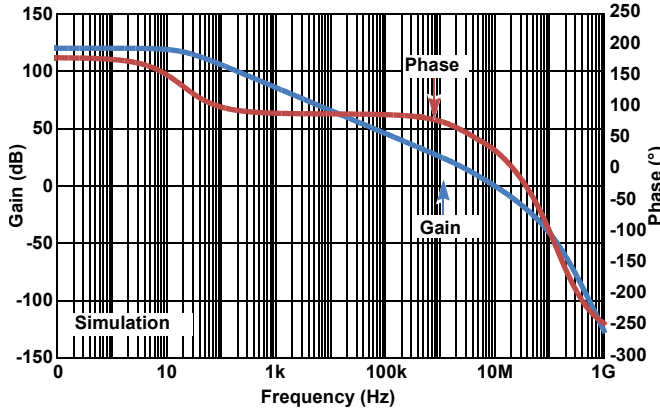

Figure 33. Open-Loop Frequency Response ($C_L = 100pF$)

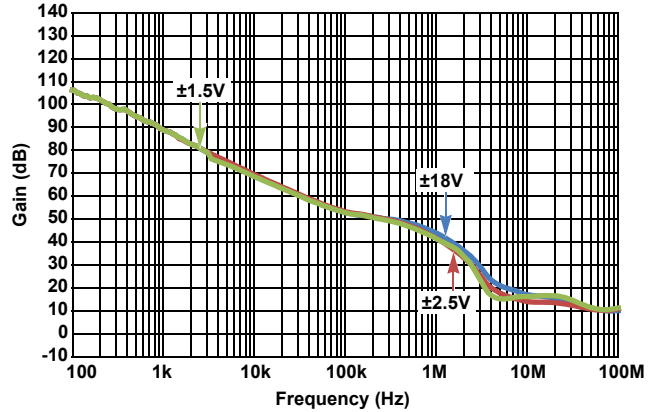

Figure 34. CMRR vs Frequency

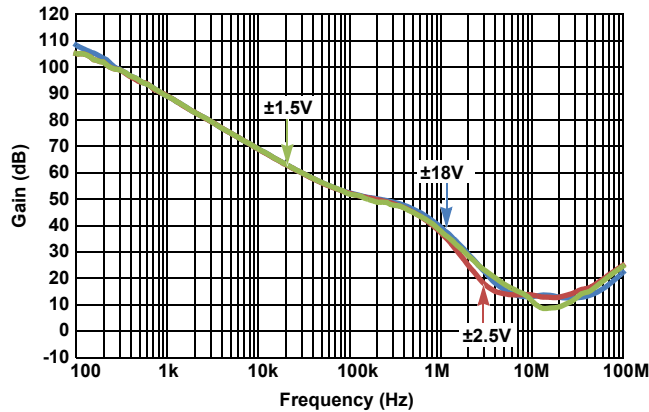

Figure 35. PSRR vs Frequency

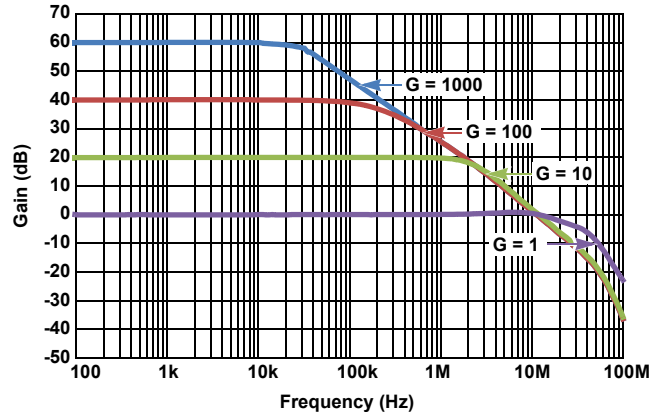

Figure 36. Frequency Response vs Closed-Loop Gain

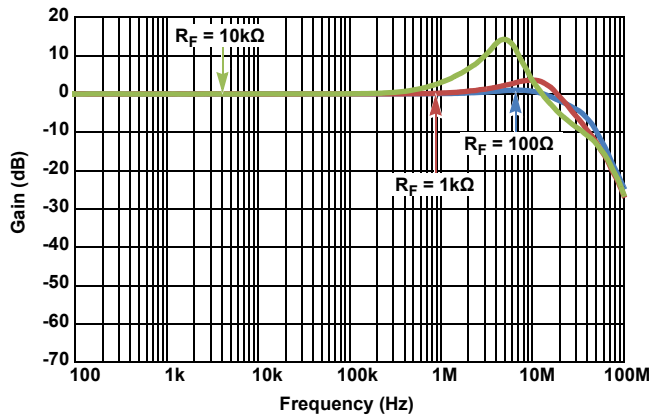

Figure 37. Frequency Response vs Feedback Resistance (R_F)

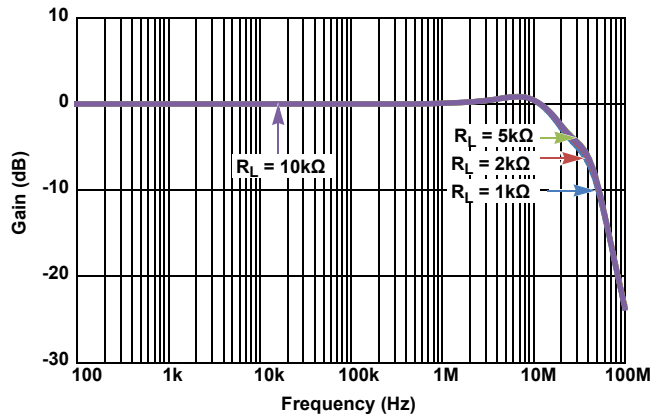

Figure 38. Frequency Response vs Load Resistance

Unless otherwise specified, $V_S \pm 18V$, $V_{CM} = 0$, $V_O = 0V$, $T_A = +25^\circ C$. (Continued)

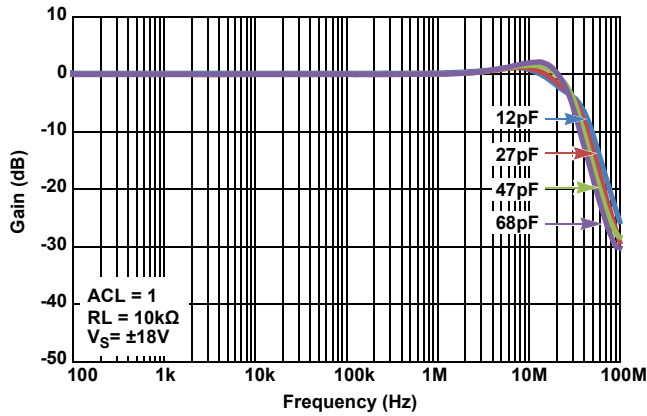

Figure 39. Unity Gain Response vs Load Capacitance

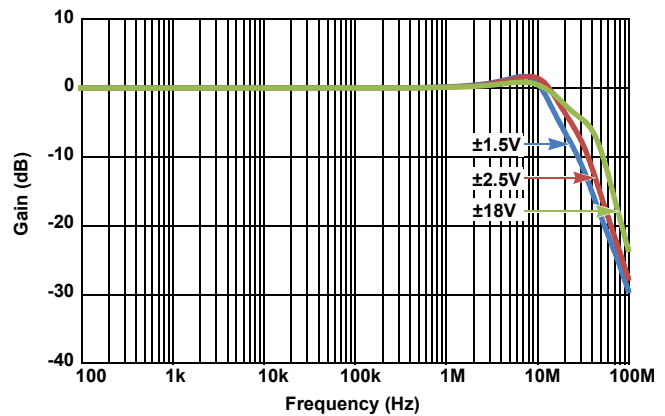

Figure 40. Frequency Response vs Supply Voltage

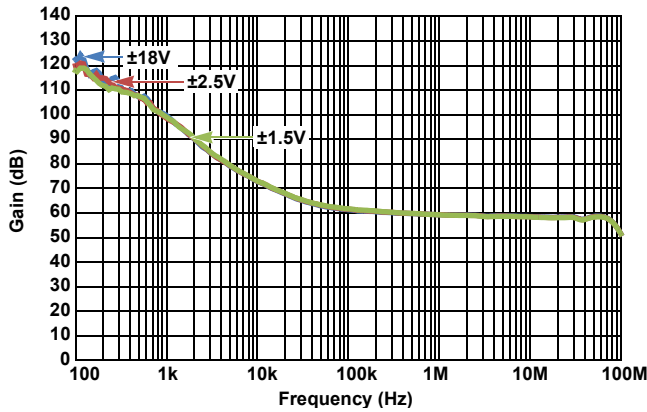

Figure 41. Crosstalk Rejection

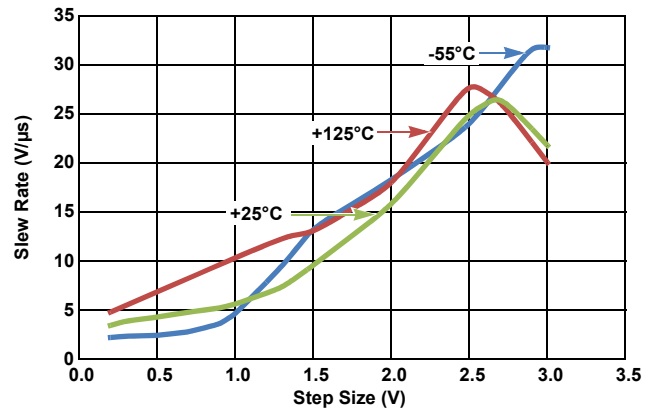

Figure 42. Slew Rate vs Step Size vs Temperature ($V_S = \pm 1.5V$)

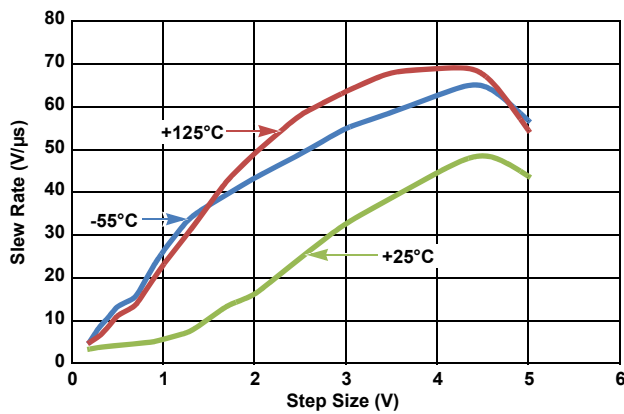

Figure 43. Slew Rate vs Step Size vs Temperature ($V_S = \pm 2.5V$)

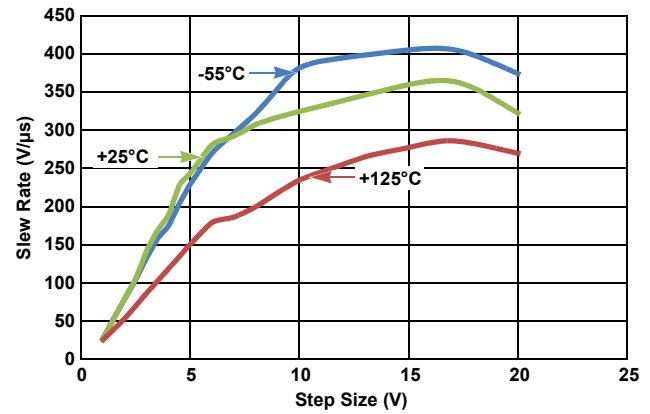

Figure 44. Slew Rate vs Step Size vs Temperature ($V_S = \pm 18V$)

Unless otherwise specified, $V_S \pm 18V$, $V_{CM} = 0$, $V_O = 0V$, $T_A = +25^\circ C$. (Continued)

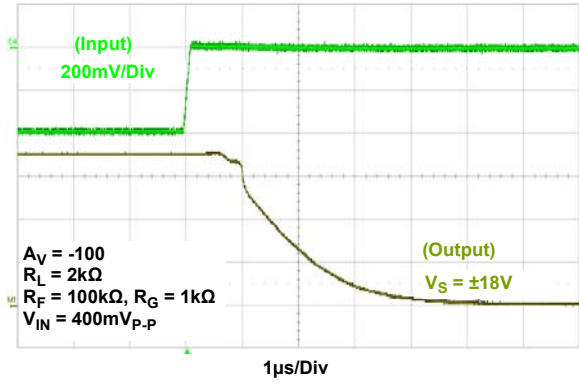

Figure 45. Saturation Recovery ($V_S = \pm 18V$)

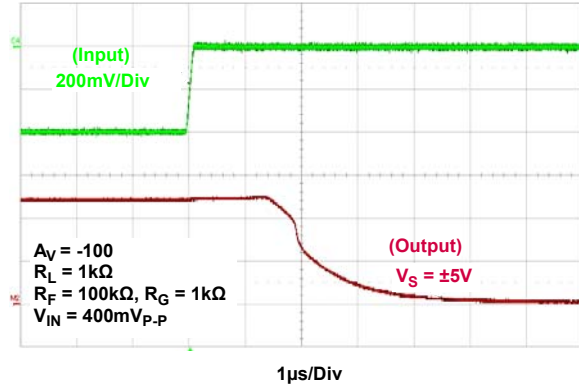

Figure 46. Saturation Recovery ($V_S = \pm 5V$)

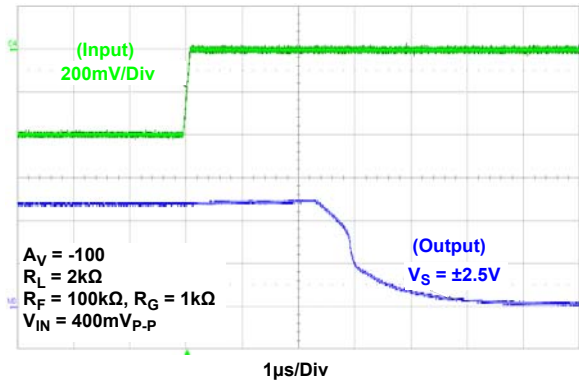

Figure 47. Saturation Recovery ($V_S = \pm 2.5V$)

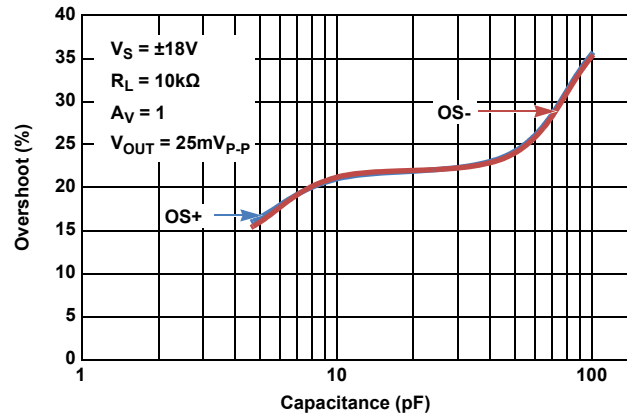

Figure 48. Overshoot (%) vs Load Capacitance

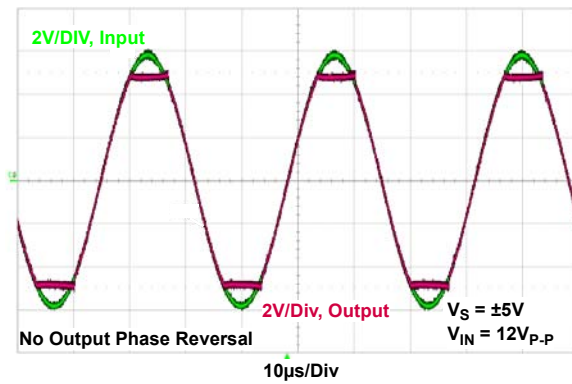

Figure 49. Input Overdrive Response

4. Applications Information

4.1 Functional Description

The ISL71444M contains four high-speed and low-power op amps designed to take advantage of its full dynamic input and output voltage range with rail-to-rail operation. By offering low power, low offset voltage, and low temperature drift coupled with its high bandwidth and enhanced slew rates upwards of 50V/ μ s, these op amps are ideal for applications requiring both high DC accuracy and AC performance. The ISL71444M is manufactured with the Renesas PR40 silicon-on-insulator process, which makes this device immune to single event latch-up and provides excellent radiation tolerance. This makes it the ideal choice for high reliability applications in harsh radiation-prone environments.

4.2 Operating Voltage Range

This device is designed to operate with a split supply rail from $\pm 1.35\text{V}$ to $\pm 20\text{V}$ or a single supply rail from 2.7V to 40V. The ISL71444M is fully characterized in production for supply rails of 5V ($\pm 2.5\text{V}$) and 36V ($\pm 18\text{V}$). The power supply rejection ratio is typically 120dB across the full operating voltage range. The worst case common-mode rejection ratio across temperature is within 1.5V to 2V of each rail. When VCM is inside that range, the CMRR performance is typically >110dB with a $\pm 18\text{V}$ supply. The minimum CMRR performance across the -55°C to $+125^\circ\text{C}$ temperature range and radiation is >70dB across the full common-mode input range for power supply voltages from $\pm 2.5\text{V}$ (5V) to $\pm 18\text{V}$ (36V).

4.3 Input Performance

The slew enhanced front-end is a block that is placed in parallel with the main input stage and functions based on the input differential.

4.4 Input ESD Diode Protection

The input terminals (IN+ and IN-) have internal ESD protection diodes to the positive and negative supply rails, series-connected 600 Ω current limiting resistors, and an anti-parallel diode pair across the inputs.

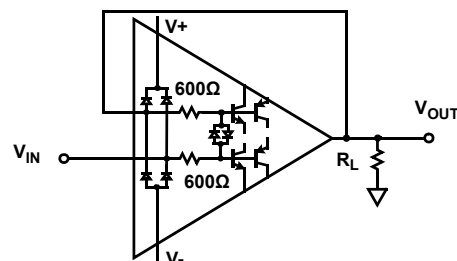

Figure 50. Input ESD Diode Current Limiting, Unity Gain

4.5 Output Short-Circuit Current Limiting

The output current limit has a worst case minimum limit of $\pm 8\text{mA}$ but may reach as high as $\pm 100\text{mA}$. The op amp can withstand a short-circuit to either rail for a short duration ($<1\text{s}$) as long as the maximum operating junction temperature is not violated. This applies to only one amplifier at a given time. Continued use of the device in these conditions may degrade the long-term reliability of the part and is not recommended. [Figure 20 on page 11](#) shows the typical short-circuit currents that can be expected. The ISL71444M's current limiting circuitry automatically lowers the current limit of the device if short-circuit conditions carry on for extended periods of time. This protects the device from malfunction; however, extended operation in this mode degrades the output rail-to-rail performance by increasing the V_{OH}/V_{OL} levels.

4.6 Output Phase Reversal

Output phase reversal is a change of polarity in the amplifier transfer function when the input voltage exceeds the supply voltage. The ISL71444M is immune to output phase reversal, even when the input voltage is 1V beyond the supplies. This is illustrated in [Figure 49 on page 16](#).

4.7 Power Dissipation

It is possible to exceed the +150°C maximum junction temperatures under certain load and power supply conditions. It is therefore important to calculate the maximum junction temperature (T_{JMAX}) for all applications to determine if power supply voltages or load conditions need to be modified to remain in the safe operating area. These parameters are related using [Equation 1](#):

$$(EQ. 1) \quad T_{JMAX} = T_{AMAX} + \theta_{JA} \times PD_{MAXTOTAL}$$

where:

- $PD_{MAXTOTAL}$ is the sum of the maximum power dissipation of each amplifier in the package (PD_{MAX})
- PD_{MAX} for each amplifier can be calculated using [Equation 2](#):

$$(EQ. 2) \quad PD_{MAX} = V_S \times I_{qMAX} + (V_S - V_{OUTMAX}) \times \frac{V_{OUTMAX}}{R_L}$$

where:

- T_{AMAX} = Maximum ambient temperature
- θ_{JA} = Thermal resistance of the package
- PD_{MAX} = Maximum power dissipation of one amplifier
- V_S = Total supply voltage
- I_{qMAX} = Maximum quiescent supply current of one amplifier
- V_{OUTMAX} = Maximum output voltage swing of the application

4.8 Slew Rate Enhancement

The ISL71444M has slew enhanced front-end that increases the drive on the output transistors proportional to the differential voltage across the inputs. This increase in output drive shows up as an increased transient current on top of the op amp's steady-state supply current. If the voltage differential between the inputs remains constant, as in comparator applications, the added drive current to the output transistors becomes steady-state and increases the DC power supply current of the IC. For this reason, Renesas recommends not using the ISL71444M in a comparator configuration.

4.9 Unused Channel Configuration

If the application does not require the use of all four op amps, you must configure the unused channels to prevent it from oscillating. Any unused channels oscillate if the input and output pins are floating. This results in higher than expected supply currents and possible noise injection into any of the active channels being used. The proper way to prevent oscillation is to short the output to the inverting input and tie the positive input to a known voltage, such as mid-supply.

When the V^- supply is less than or equal to $-1.0V$, configure your op amp as in [Figure 51](#), otherwise follow the configuration shown in [Figure 52](#). The resistors in [Figure 52](#) are of equal value and high resistance ($\geq 10k\Omega$) to minimize current draw, while keeping the positive input at mid-supply. All unused op amps can have their inputs tied to the same resistor divider to minimize the number of components.

Tying the positive input to ground in [Figure 52](#) (where $V^- = GND$) produces a voltage differential across the inputs as the inverting input is at the V_{OL} of the op amp and the positive input is at GND , thereby increasing the steady-state supply current. While this does not damage the op amp, the increased supply current can result in additional unnecessary power dissipation.

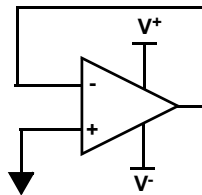

Figure 51. Preventing Oscillations in Unused Channels

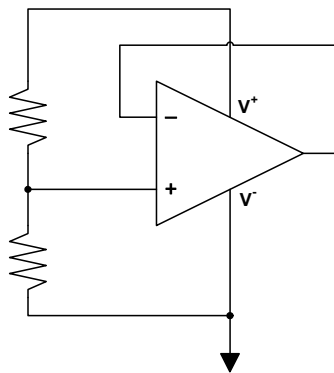

Figure 52. Preventing Oscillations in Unused Channels, Single Supply

5. Radiation Tolerance

The ISL71444M is a radiation tolerant device for commercial space applications, Low Earth Orbit (LEO) applications, high altitude avionics, launch vehicles, and other harsh environments. This device's response to Total Ionizing Dose (TID) radiation effects and Single Event Effects (SEE) has been measured, characterized, and reported in the preceding sections. However, TID performance is not guaranteed through radiation acceptance testing, nor is the characterized SEE characterized performance guaranteed.

5.1 Total Ionizing Dose (TID) Testing

5.1.1 Introduction

Total dose testing of the ISL71444MVZ-T proceeded in accordance with the guidelines of MIL-STD-883 Test Method 1019. The experimental matrix consisted of 18 samples irradiated under bias, as shown in [Table 1 on page 21](#), and 18 samples irradiated with all pins grounded (unbiased). Three control units were used. The bias configuration is shown in [Figure 53](#).

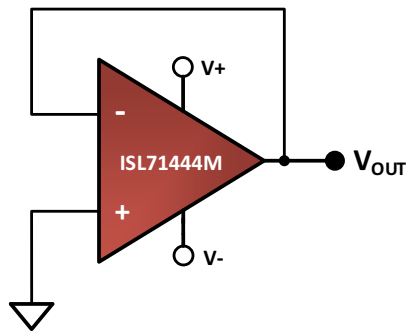

Notes:
V+ = +18V, V- = -18V

Figure 53. Irradiation Bias Configuration for the IS71444M

Samples of the ISL71444MVZ-T were drawn from fabrication lot X7J8AB and were packaged in the production 14 Ld plastic TSSOP, Package Outline Drawing (POD) M14.173. The samples were screened to datasheet limits at room temperature only, before irradiation.

Total dose irradiations were performed using a Hopewell Designs N40 panoramic vault-type low dose rate ⁶⁰Co irradiator located in the Renesas Palm Bay, Florida facility. The dose rate was 0.0089rad(Si)/s (8.9mrad(Si)/s). PbAl spectrum hardening filters were used to shield the test board and devices under test against low energy secondary gamma radiation.

Downpoints for the testing were 0krad(Si), 10krad(Si), 20krad(Si), and 30krad(Si). Following irradiation, the samples were subjected to a high temperature biased anneal for 168 hours at +100°C.

All electrical testing was performed outside the irradiator using production Automated Test Equipment (ATE) with data logging of all parameters at each downpoint. All downpoint electrical testing was performed at room temperature.

5.1.2 Results

Table 1 summarizes the attributes data. “Bin 1” indicates a device that passes all datasheet specification limits.

Table 1. ISL71444M Total Dose Test Attributes Data

Dose Rate (mrad(Si)/s)	Bias	Sample Size	Down Point	Bin 1	Rejects
8.75	Figure 53	18	Pre-rad	18	
			10krad(Si)	18	0
			20krad(Si)	18	0
			30krad(Si)	18	0
			Anneal	18	0
8.75	Grounded	18	Pre-rad	18	
			10krad(Si)	18	0
			20krad(Si)	18	0
			30krad(Si)	18	0
			Anneal	18	0

The plots in [Figure 54](#) through [58](#) show data for key parameters at all downpoints. The plots show the average as a function of total dose for each of the irradiation conditions; we chose to use the average because of the relatively large sample sizes. All parts showed excellent stability over irradiation.

[Table 2 on page 22](#) shows the average of other key parameters with respect to total dose in tabular form.

5.1.3 Conclusion

As shown in [Table 2](#) and the selected graphs ([Figures 54](#) through [58](#)), all parameters showed excellent stability over irradiation, with no observed bias sensitivity. For brevity, only the ±18V results are shown; the ±2.5V and ±1.5V results were just as stable.

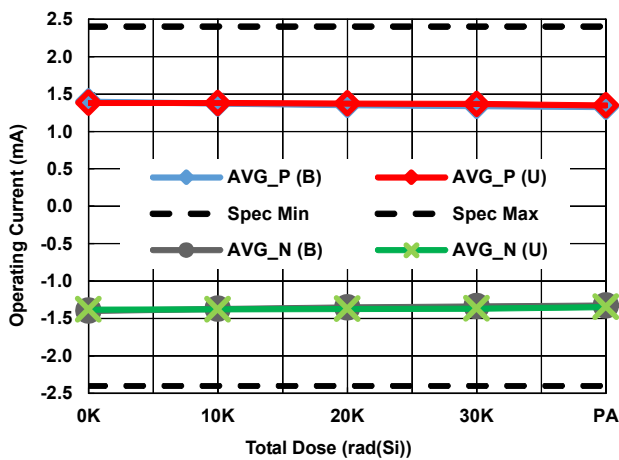

Figure 54. Operating Supply Current vs TID $V_S = \pm 18V$

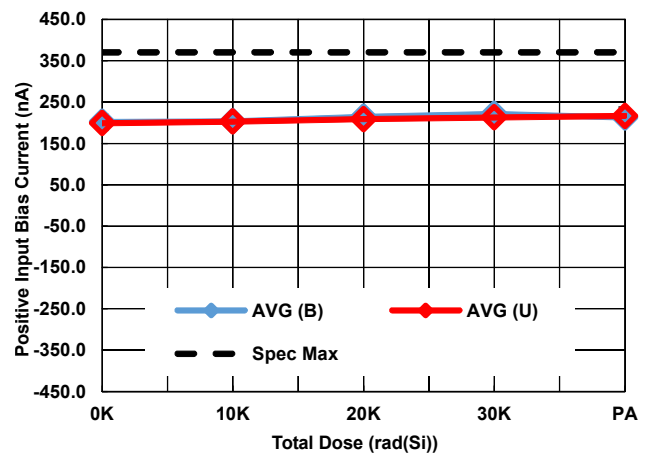

Figure 55. Positive Input Bias Current vs TID ($V_S = \pm 18V$)

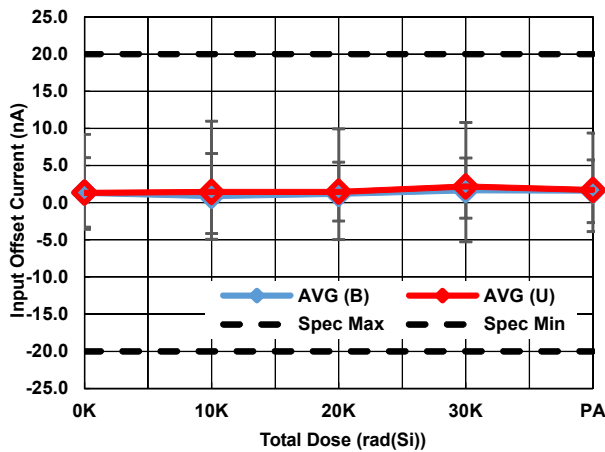

Figure 56. Input Offset Current vs TID ($V_S = \pm 18V$)

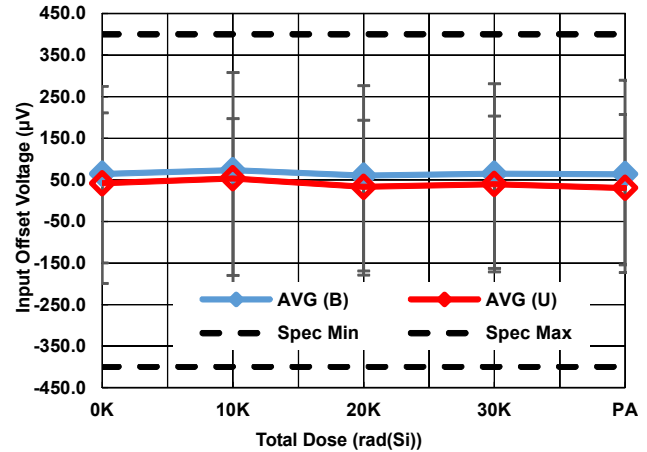

Figure 57. Input Offset Voltage vs TID ($V_S = \pm 18V$)

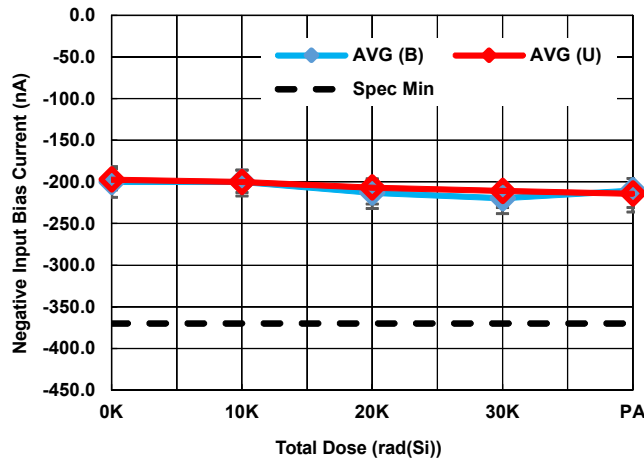

Figure 58. Negative Input Bias Current vs TID ($V_S = \pm 18V$)

Figure 59.

Table 2. ISL71444M Response of Key Parameters vs. TID ($V_S = \pm 18V$)

Parameter	Condition	Bias	0krad(Si)	10krad(Si)	20krad(Si)	30krad(Si)	Post Anneal	Units
Quad Power Supply Current (Positive) $V_S = \pm 18.0V$	I_{S+}	Avg (Biased)	1.40	1.38	1.35	1.35	1.33	mA
		Avg (Unbiased)	1.38	1.38	1.38	1.38	1.35	
		Limit -	-	-	-	-	-	
		Limit +	11	11	11	11	11	
Quad Power Supply Current (Negative) $V_S = \pm 18.0V$	I_{S-}	Avg (Biased)	-1.40	-1.38	-1.35	-1.35	-1.33	mA
		Avg (Unbiased)	-1.38	-1.38	-1.38	-1.38	-1.35	
		Limit -	-11	-11	-11	-11	-11	
		Limit +	-	-	-	-	-	

Table 2. ISL71444M Response of Key Parameters vs. TID ($V_S = \pm 18V$) (Continued)

Parameter	Condition	Bias	0krad(Si)	10krad(Si)	20krad(Si)	30krad(Si)	Post Anneal	Units
Power Supply Current/Amplifier (Positive) $V_S = \pm 18.0V$	I_{S+}	Avg (Biased)	1.40	1.37	1.35	1.34	1.33	mA
		Avg (Unbiased)	1.38	1.38	1.37	1.37	1.35	
		Limit -	-	-	-	-	-	
		Limit +	2.40	2.40	2.40	2.40	2.40	
Power Supply Current/Amplifier (Negative) $V_S = \pm 18.0V$	I_{S-}	Avg (Biased)	-1.40	-1.37	-1.35	-1.34	-1.33	mA
		Avg (Unbiased)	-1.38	-1.38	-1.37	-1.37	-1.35	
		Limit -	-2.40	-2.40	-2.40	-2.40	-2.40	
		Limit +	-	-	-	-	-	
Input Offset Voltage $V_S = \pm 18.0V$ $V_{CM} = 0V$	V_{OS}	Avg (Biased)	64.25	73.07	59.85	64.56	63.30	μV
		Avg (Unbiased)	54.14	69.28	62.96	68.76	63.93	
		Limit -	-400.00	-400.00	-400.00	-400.00	-400.00	
		Limit +	400.00	400.00	400.00	400.00	400.00	
Positive Input Bias Current $V_S = \pm 18.0V$ $V_{CM} = 0V$	I_{B+}	Avg (Biased)	201.94	203.47	214.55	221.37	212.41	nA
		Avg (Unbiased)	199.06	203.03	208.65	213.11	216.28	
		Limit -	-	-	-	-	-	
		Limit +	370.00	370.00	370.00	370.00	370.00	
Negative Input Bias Current $V_S = \pm 18.0V$ $V_{CM} = 0V$	I_{B-}	Avg (Biased)	-200.23	-199.89	-213.05	-219.70	-210.44	nA
		Avg (Unbiased)	-197.37	-200.14	-206.89	-210.92	-214.22	
		Limit -	-370.00	-370.00	-370.00	-370.00	-370.00	
		Limit +	-	-	-	-	-	
Input Offset Current $V_S = \pm 18.0V$ $V_{CM} = 0V$	I_{OS}	Avg (Biased)	1.34	0.91	1.18	1.68	1.62	nA
		Avg (Unbiased)	1.33	1.45	1.46	2.17	1.70	
		Limit -	-20.00	-20.00	-20.00	-20.00	-20.00	
		Limit +	20.00	20.00	20.00	20.00	20.00	
Output Voltage High $V_S = \pm 18.0V$ $R_L = \text{No Load}$	V_{OH}	Avg (Biased)	24.32	23.98	23.76	25.42	24.10	mV
		Avg (Unbiased)	24.16	23.98	23.97	25.76	24.29	
		Limit -	-	-	-	-	-	
		Limit +	160.00	160.00	160.00	160.00	160.00	
Output Voltage Low $V_S = \pm 18.0V$ $R_L = \text{No Load}$	V_{OL}	Avg (Biased)	21.45	21.00	20.50	19.86	20.24	mV
		Avg (Unbiased)	21.44	20.70	20.40	19.86	20.43	
		Limit -	-	-	-	-	-	
		Limit +	160.00	160.00	160.00	160.00	160.00	
Open Loop Gain (Positive) $V_S = \pm 18.0V$ $R_L = 10k\Omega$	A_{VOL+}	Avg (Biased)	126.75	123.87	125.94	125.16	124.89	dB
		Avg (Unbiased)	126.84	125.41	126.31	125.88	125.28	
		Limit -	96.00	96.00	96.00	96.00	96.00	
		Limit +	-	-	-	-	-	
Open Loop Gain (Negative) $V_S = \pm 18.0V$ $R_L = 10k\Omega$	A_{VOL-}	Avg (Biased)	127.71	126.21	126.98	126.18	126.15	dB
		Avg (Unbiased)	127.74	127.43	127.45	126.89	126.44	
		Limit -	96.00	96.00	96.00	96.00	96.00	
		Limit +	-	-	-	-	-	

Table 2. ISL71444M Response of Key Parameters vs. TID ($V_S = \pm 18V$) (Continued)

Parameter	Condition	Bias	0krad(Si)	10krad(Si)	20krad(Si)	30krad(Si)	Post Anneal	Units
Power Supply Rejection Ratio (Positive) $V_{S+} = +18.0V$ $V_{S-} = -0.5V$ to $-18.0V$	PSRR+	Avg (Biased)	107.45	107.91	107.44	107.36	106.78	dB
		Avg (Unbiased)	106.97	107.15	107.04	107.23	106.13	
		Limit -	88.00	88.00	88.00	88.00	88.00	
		Limit +	-	-	-	-	-	
Power Supply Rejection Ratio (Negative) $V_{S-} = -18.0V$ $V_{S+} = 0.5V$ to $18.0V$	PSRR-	Avg (Biased)	119.00	117.83	118.13	118.44	118.57	dB
		Avg (Unbiased)	118.32	119.54	119.24	119.45	120.67	
		Limit -	88.00	88.00	88.00	88.00	88.00	
		Limit +	-	-	-	-	-	
Common Mode Rejection Ratio $V_S = \pm 18.0V$ $V_{CM} = -18.0V$ to $18.0V$	CMRR	Avg (Biased)	113.56	114.96	114.37	113.84	112.61	dB
		Avg (Unbiased)	114.19	113.75	113.81	113.81	113.23	
		Limit -	70.00	70.00	70.00	70.00	70.00	
		Limit +	-	-	-	-	-	
Common Mode Rejection Ratio $V_S = \pm 18.0V$ $V_{CM} = -17.5V$ to $17.5V$	CMRR	Avg (Biased)	113.46	114.53	114.56	113.74	112.40	dB
		Avg (Unbiased)	114.30	113.81	114.14	113.78	113.18	
		Limit -	80.00	80.00	80.00	80.00	80.00	
		Limit +	-	-	-	-	-	
Large Signal Slew Rate (Rising) $V_S = \pm 18.0V$, Gain = 1, $R_L = 2k\Omega$, $V_{OUT} = 10V_{P-P}$	SR _R	Avg (Biased)	270.93	266.86	271.30	307.91	299.42	V/ μ s
		Avg (Unbiased)	267.55	263.76	268.97	307.94	295.27	
		Limit -	60.00	60.00	60.00	60.00	60.00	
		Limit +	-	-	-	-	-	
Large Signal Slew Rate (Falling) $V_S = \pm 18.0V$, Gain = 1, $R_L = 2k\Omega$, $V_{OUT} = 10V_{P-P}$	SR _F	Avg (Biased)	184.24	154.23	152.27	194.45	193.17	V/ μ s
		Avg (Unbiased)	182.06	151.46	155.41	196.00	194.74	
		Limit -	60.00	60.00	60.00	60.00	60.00	
		Limit +	-	-	-	-	-	

5.2 Single Event Effects Testing

5.2.1 Introduction

The intense heavy ion environment encountered in space applications can cause a variety of Single Event Effects (SEE). SEE can lead to system-level performance issues including disruption, degradation, and destruction. For predictable and reliable space system operation, individual electronic components should be characterized to determine their SEE response. The following is a summary of the ISL71444M SEE testing.

5.2.2 SEE Test Setup

Testing was performed at the Texas A&M University (TAMU) Cyclotron Institute heavy ion facility. This facility is coupled to a K500 super-conducting cyclotron, which is capable of generating a wide range of test particles with the various energy, flux, and fluence levels needed for advanced radiation testing.

The test circuit is a non-inverting configuration with a gain of 10. Digital multimeters were used to monitor the supply voltage (V_{+}/V_{-}), output voltage (V_{OUT}), and supply current (I_{+}/I_{-}). The outputs were monitored using four LeCroy 4-channel digital oscilloscopes to capture and store the signal waveforms. [Table 3](#) shows the scope configuration used during the testing.

Table 3. Oscilloscope Setup for SET Testing

Scope	CH 1	CH 2	CH 3	CH 4	Trigger
1	OUTA	OUTB	OUTC	OUTD	CH1, 1% of OUTA
2	OUTA	OUTB	OUTC	OUTD	CH2, 1% of OUTB
3	OUTA	OUTB	OUTC	OUTD	CH3, 1% of OUTC
4	OUTA	OUTB	OUTC	OUTD	CH4, 1% of OUTD

5.2.3 SEB/SEL Testing Results

A failure due to burnout was indicated by a permanent change to the part's supply current or output voltage after the beam was turned off. If the part's supply current or output voltage reverted back to its pre-exposure value after a power cycle, the event was deemed as latch-up. A failure for burnout was indicated by a $\pm 4\%$ delta (which would allow for measurement repeatability) in supply current or output voltage. The ISL71444M units did not exceed the aforementioned limits with $V_S = \pm 20V$ at an LET of $43MeV \cdot cm^2/mg$ and therefore are deemed as passing. The output voltage of the amplifiers had a 0% delta pre and post exposure for all channels and all parts and thus are not shown for brevity.

Table 4. SEB/SEL Results ($V_S = \pm 20V$, LET = $43MeV \cdot cm^2/mg$)

Unit	Temp (°C)	Supply Current Pre-Exposure		Supply Current Post-Exposure		SEB/L
		I+ (mA)	I- (mA)	I+ (mA)	I- (mA)	
1	+125	8.54	7.52	8.26	7.53	Pass
2	+125	9.18	8.44	9.15	8.41	Pass
3	+125	8.10	7.37	8.08	7.36	Pass
4	+125	8.07	7.34	8.06	7.33	Pass

5.2.4 Single Event Transient Testing

Single Event Transient (SET) testing was conducted in a gain of 10 non-inverting with a 0.1V input with a supply voltage of $\pm 1.35V$ and an input of 0.2V with supplies at $\pm 15.0V$.

The plots in [Figure 60](#) through [Figure 61](#) show the typical SET performance of the ISL71444M at $LET = 43MeV \cdot cm^2/mg$. Fluence was run at $2 \times 10^6/cm^2$.

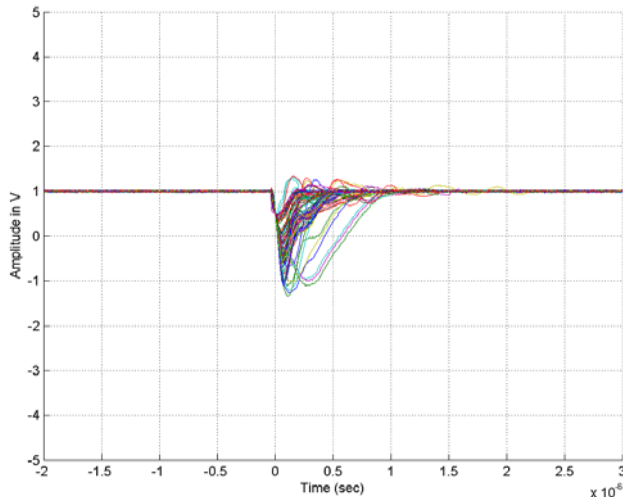

Figure 60. SET Response with $V_S = \pm 1.35V$

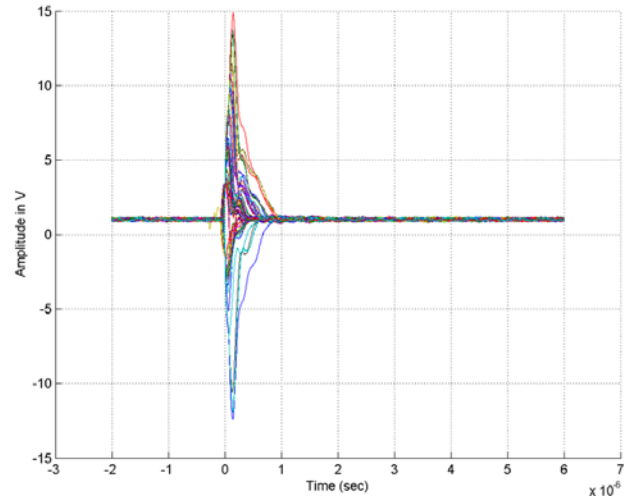

Figure 61. SET Response with $V_S = \pm 15.0V$

With an $LET = 43MeV \cdot cm^2/mg$, all transients lasted no longer than $1\mu s$ regardless of supply voltage. Voltage deviations were predominantly negative-going down to $-1.35V$ with supplies at $\pm 1.35V$. With $\pm 15V$ supplies, the voltage deviations were both positive up to $+15V$ and negative down to approximately $-12V$.

6. Revision History

Rev.	Date	Description
2.00	Aug 16, 2019	Updated links throughout document. Added Slew Rate Enhancement section. Updated Unused Channel Configuration section. Updated disclaimer.
1.00	Apr 6, 2018	Added Features bullet on page 1. Added Section 2.2 Outgas Testing on page 5. Removed About Intersil section and added Renesas disclaimer.
0.00	Jun 6, 2017	Initial release

7. Package Outline Drawing

For the most recent package outline drawing, see [M14.173](#).

M14.173
 14 LD THIN SHRINK SMALL OUTLINE PACKAGE (TSSOP)
 Rev 3, 10/09

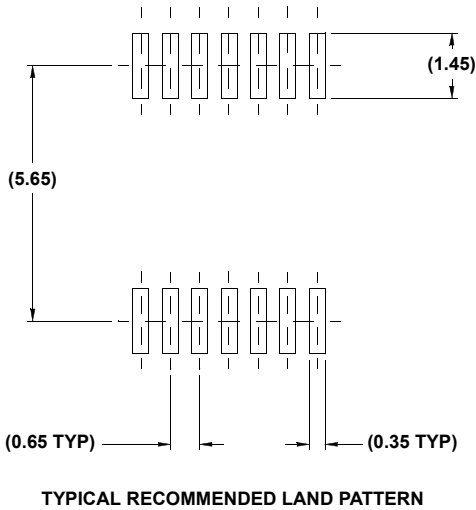
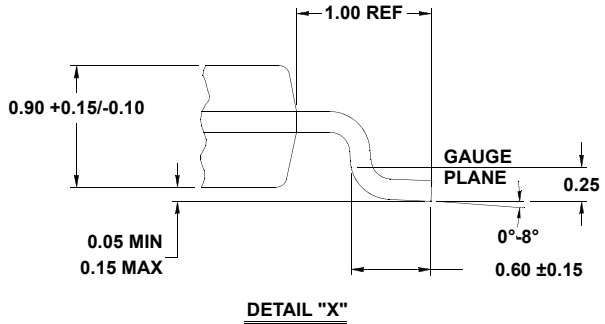
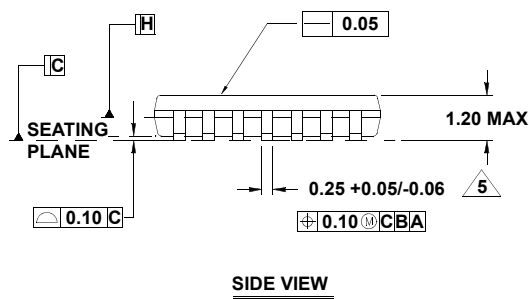
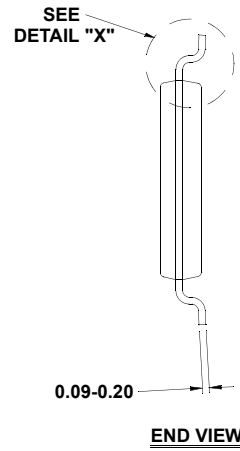
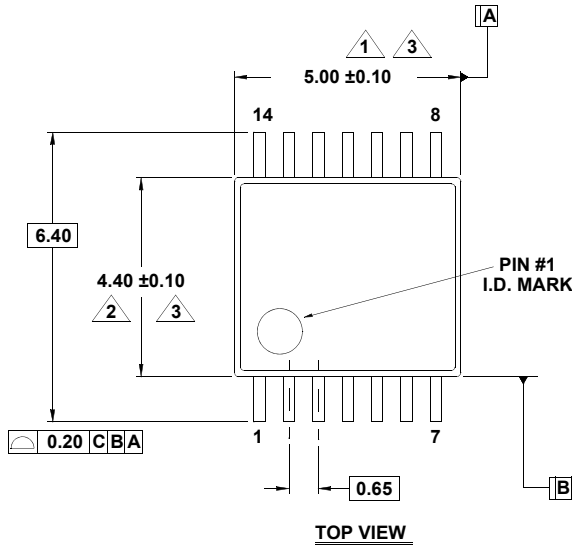

NOTES:

1. Dimension does not include mold flash, protrusions or gate burrs. Mold flash, protrusions or gate burrs shall not exceed 0.15 per side.
2. Dimension does not include interlead flash or protrusion. Interlead flash or protrusion shall not exceed 0.25 per side.
3. Dimensions are measured at datum plane H.
4. Dimensioning and tolerancing per ASME Y14.5M-1994.
5. Dimension does not include dambar protrusion. Allowable protrusion shall be 0.80mm total in excess of dimension at maximum material condition. Minimum space between protrusion and adjacent lead is 0.07mm.
6. Dimension in () are for reference only.
7. Conforms to JEDEC MO-153, variation AB-1.

IMPORTANT NOTICE AND DISCLAIMER

RENESAS ELECTRONICS CORPORATION AND ITS SUBSIDIARIES (“RENESAS”) PROVIDES TECHNICAL SPECIFICATIONS AND RELIABILITY DATA (INCLUDING DATASHEETS), DESIGN RESOURCES (INCLUDING REFERENCE DESIGNS), APPLICATION OR OTHER DESIGN ADVICE, WEB TOOLS, SAFETY INFORMATION, AND OTHER RESOURCES “AS IS” AND WITH ALL FAULTS, AND DISCLAIMS ALL WARRANTIES, EXPRESS OR IMPLIED, INCLUDING, WITHOUT LIMITATION, ANY IMPLIED WARRANTIES OF MERCHANTABILITY, FITNESS FOR A PARTICULAR PURPOSE, OR NON-INFRINGEMENT OF THIRD PARTY INTELLECTUAL PROPERTY RIGHTS.

These resources are intended for developers skilled in the art designing with Renesas products. You are solely responsible for (1) selecting the appropriate products for your application, (2) designing, validating, and testing your application, and (3) ensuring your application meets applicable standards, and any other safety, security, or other requirements. These resources are subject to change without notice. Renesas grants you permission to use these resources only for development of an application that uses Renesas products. Other reproduction or use of these resources is strictly prohibited. No license is granted to any other Renesas intellectual property or to any third party intellectual property. Renesas disclaims responsibility for, and you will fully indemnify Renesas and its representatives against, any claims, damages, costs, losses, or liabilities arising out of your use of these resources. Renesas' products are provided only subject to Renesas' Terms and Conditions of Sale or other applicable terms agreed to in writing. No use of any Renesas resources expands or otherwise alters any applicable warranties or warranty disclaimers for these products.

(Rev.1.0 Mar 2020)

Corporate Headquarters

TOYOSU FORESIA, 3-2-24 Toyosu,
Koto-ku, Tokyo 135-0061, Japan
www.renesas.com

Contact Information

For further information on a product, technology, the most up-to-date version of a document, or your nearest sales office, please visit:
www.renesas.com/contact/

Trademarks

Renesas and the Renesas logo are trademarks of Renesas Electronics Corporation. All trademarks and registered trademarks are the property of their respective owners.

Данный компонент на территории Российской Федерации

Вы можете приобрести в компании MosChip.

Для оперативного оформления запроса Вам необходимо перейти по данной ссылке:

<http://moschip.ru/get-element>

Вы можете разместить у нас заказ для любого Вашего проекта, будь то серийное производство или разработка единичного прибора.

В нашем ассортименте представлены ведущие мировые производители активных и пассивных электронных компонентов.

Нашей специализацией является поставка электронной компонентной базы двойного назначения, продукции таких производителей как XILINX, Intel (ex.ALTERA), Vicor, Microchip, Texas Instruments, Analog Devices, Mini-Circuits, Amphenol, Glenair.

Сотрудничество с глобальными дистрибьюторами электронных компонентов, предоставляет возможность заказывать и получать с международных складов практически любой перечень компонентов в оптимальные для Вас сроки.

На всех этапах разработки и производства наши партнеры могут получить квалифицированную поддержку опытных инженеров.

Система менеджмента качества компании отвечает требованиям в соответствии с ГОСТ Р ИСО 9001, ГОСТ РВ 0015-002 и ЭС РД 009

Офис по работе с юридическими лицами:

105318, г.Москва, ул.Щербаковская д.3, офис 1107, 1118, ДЦ «Щербаковский»

Телефон: +7 495 668-12-70 (многоканальный)

Факс: +7 495 668-12-70 (доб.304)

E-mail: info@moschip.ru

Skype отдела продаж:

moschip.ru

moschip.ru_4

moschip.ru_6

moschip.ru_9