

Two-Piece 4.0mm Pitch Battery

9155-400

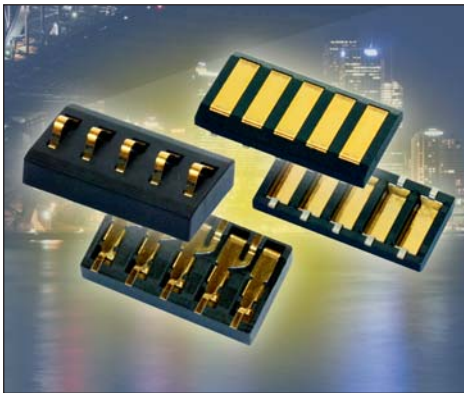

This unique battery or removable module style connector is different from most others in that it allows for the pluggable device to be swiped or connected from either direction. The spring contact offers enhanced contact deflection range over existing connectors in the market with a full 1.4mm of travel after contact engagement. This contact design allows the connector to absorb more of the plastic or housing tolerances making it more functional and reliable in real life applications.

The fixed pad connector is unique in the industry as it replaces the plating of gold directly onto PCB pads. The main benefit of using this connector is to elevate the pad surface well above the PCB so that the gold contacts are close to flush with the outside packaging. This minimizes the distance that a spring contact would need to absorb in the mating tolerance band. Also unique to this connector is the angled contact lead-in on both sides which facilitates smooth engagement of the spring contact from either direction.

APPLICATIONS

- Portable electronics requiring a removable battery
- Interface for removable/pluggable modules or cartridges
- Docking cradle for charging and data transfer

FEATURES AND BENEFITS

- Proven contact reliability in harsh industrial or medical applications
- Increased contact deflection range above existing connectors on the market
- Gold plated Beryllium contact spring contact assures maximum contact reliability and functionality up to 5000 cycles
- Beveled lead in on pad connector facilitates smooth module engagement from either direction

ELECTRICAL

- Current Rating: 5A/contact
- Voltage Rating: 125 VAC

ENVIRONMENTAL

- Operating Temperature: -40°C to +125°C

MECHANICAL

- Contact Material: Spring contact is Be Cu, Fixed contact is Phosphor Bronze
- Contact Plating: Gold over nickel mating area, pure Tin SMT tails
- Durability 5000 Cycles

HOW TO ORDER

| | | |
|-----------|-------------|----------------|
| 00 | 9155 | 005 |
| Prefix | Series | Number of Ways |
| | | 002 = 2 |
| | | 003 = 3 |
| | | 004 = 4 |
| | | 005 = 5 |
| | | 006 = 6 |

40X

Standard Battery Connector

| Code | Description | Reel Qty. |
|------|---------------------------------|-----------|
| 401 | Battery Connector - Sprung Half | 550 |
| 402 | Battery Connector - Fixed Half | 1100 |

00X

Plating Option

- 6 = 0.4µm Selective Gold, Pure Tin Tail
- 8 = 0.8µm Selective Gold, Pure Tin Tail



Two-Piece 4.0mm Pitch Battery

9155-400

2 WAY BATTERY CONNECTOR – SPRUNG HALF



DETAIL A



SECTION ON Z-Z



NOTES:

1. GENERAL TOLERANCE ± 0.20 UNLESS OTHERWISE STATED.
2. FOR FURTHER DETAILS REFER TO AVX SPECIFICATION 201-01-207.
3. ADDITIONAL INFORMATION AND BASIC MATING DETAILS REFER TO PAGES 12-14.
4. PACKING DETAILS ON PAGE 15.
5. CONNECTOR OUTLINE.
6. RECOMMENDED PLATING ON MATING PADS. GOLD OVER NICKEL.
7. FOR OTHER TAN VERTICAL MATING WE RECOMMEND MATING WITH THE FIXED CONNECTOR, REFER TO PAGE 13.

Two-Piece 4.0mm Pitch Battery

9155-400

3 WAY BATTERY CONNECTOR – SPRUNG HALF

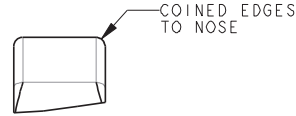

DETAIL A

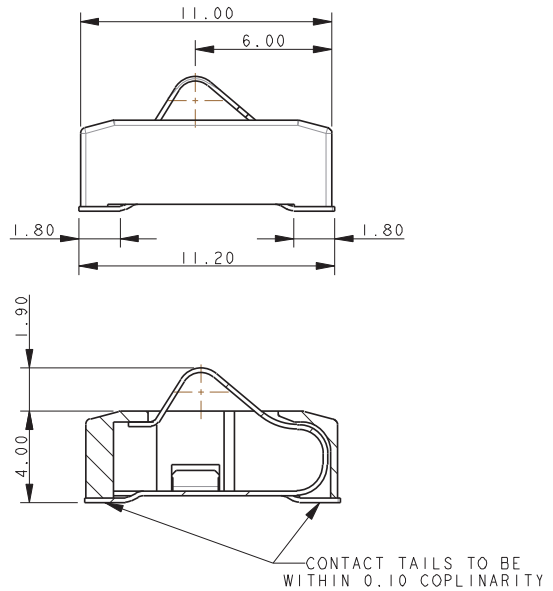

SECTION ON Z-Z



SUGGESTED MATING PCB LAYOUT



SUGGESTED SMT PCB LAYOUT

TIN PLATE PADS
2.29 x 1.07
(5 POSITIONS)

NOTES:

1. GENERAL TOLERANCE ± 0.20 UNLESS OTHERWISE STATED.
2. FOR FURTHER DETAILS REFER TO AVX SPECIFICATION 201-01-207.
3. ADDITIONAL INFORMATION AND BASIC MATING DETAILS REFER TO PAGES 12-14.
4. PACKING DETAILS ON PAGE 15.
5. CONNECTOR OUTLINE.
6. RECOMMENDED PLATING ON MATING PADS. GOLD OVER NICKEL.
7. FOR OTHER TAN VERTICAL MATING WE RECOMMEND MATING WITH THE FIXED CONNECTOR, REFER TO PAGE 13.

Two-Piece 4.0mm Pitch Battery

9155-400

4 WAY BATTERY CONNECTOR – SPRUNG HALF



DETAIL A



SECTION ON Z-Z

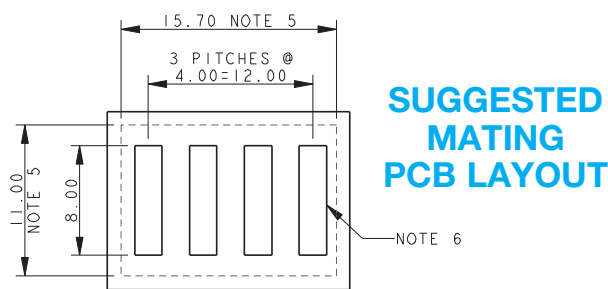

NOTES:

1. GENERAL TOLERANCE ± 0.20 UNLESS OTHERWISE STATED.
2. FOR FURTHER DETAILS REFER TO AVX SPECIFICATION 201-01-207.
3. ADDITIONAL INFORMATION AND BASIC MATING DETAILS REFER TO PAGES 12-14.
4. PACKING DETAILS ON PAGE 15.
5. CONNECTOR OUTLINE.
6. RECOMMENDED PLATING ON MATING PADS. GOLD OVER NICKEL.
7. FOR OTHER TAN VERTICAL MATING WE RECOMMEND MATING WITH THE FIXED CONNECTOR, REFER TO PAGE 13.

Two-Piece 4.0mm Pitch Battery

9155-400

5 WAY BATTERY CONNECTOR – SPRUNG HALF

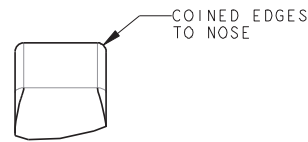

DETAIL A

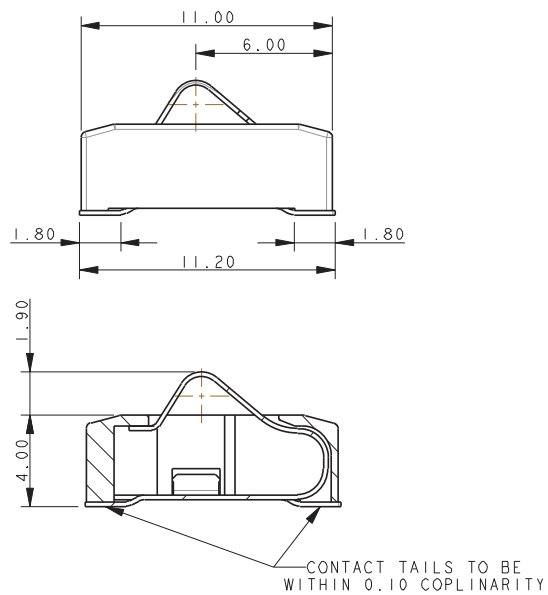

SECTION ON Z-Z

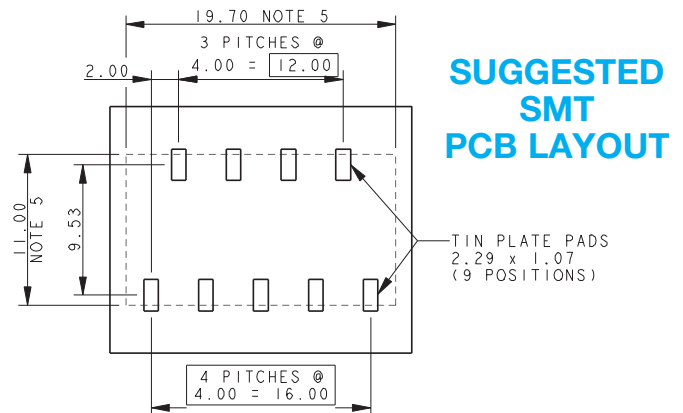

NOTES:

1. GENERAL TOLERANCE ± 0.20 UNLESS OTHERWISE STATED.
2. FOR FURTHER DETAILS REFER TO AVX SPECIFICATION 201-01-207.
3. ADDITIONAL INFORMATION AND BASIC MATING DETAILS REFER TO PAGES 12-14.
4. PACKING DETAILS ON PAGE 15.
5. CONNECTOR OUTLINE.
6. RECOMMENDED PLATING ON MATING PADS. GOLD OVER NICKEL.
7. FOR OTHER TAN VERTICAL MATING WE RECOMMEND MATING WITH THE FIXED CONNECTOR, REFER TO PAGE 13.

Two-Piece 4.0mm Pitch Battery

9155-400

6 WAY BATTERY CONNECTOR – SPRUNG HALF

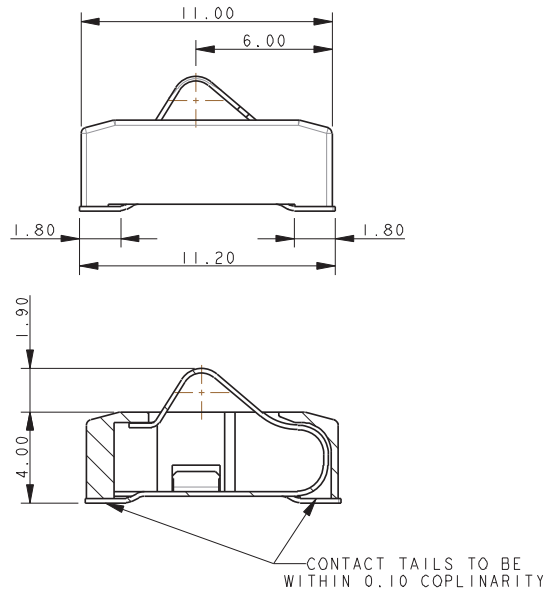

SECTION ON Z-Z

SUGGESTED SMT PCB LAYOUT

SUGGESTED MATING PCB LAYOUT

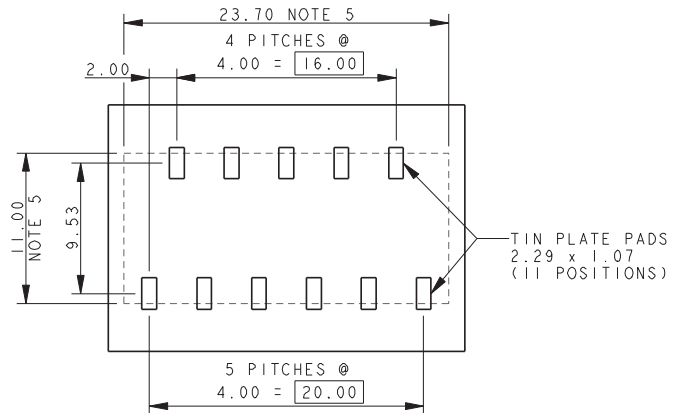
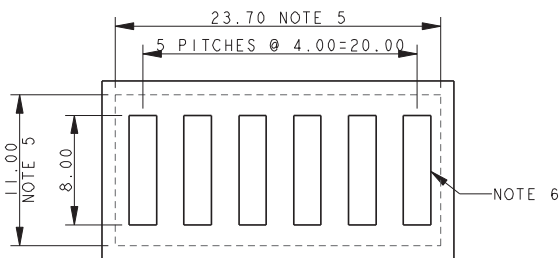

NOTES:

1. GENERAL TOLERANCE ± 0.20 UNLESS OTHERWISE STATED.
2. FOR FURTHER DETAILS REFER TO AVX SPECIFICATION 201-01-207.
3. ADDITIONAL INFORMATION AND BASIC MATING DETAILS REFER TO PAGES 12-14.
4. PACKING DETAILS ON PAGE 15.
5. CONNECTOR OUTLINE.
6. RECOMMENDED PLATING ON MATING PADS. GOLD OVER NICKEL.
7. FOR OTHER TAN VERTICAL MATING WE RECOMMEND MATING WITH THE FIXED CONNECTOR, REFER TO PAGE 13.

Two-Piece 4.0mm Pitch Battery

9155-400

2 WAY BATTERY CONNECTOR – FIXED HALF OPTIONAL



NOTES:

1. GENERAL TOLERANCE ± 0.20 UNLESS OTHERWISE STATED.
2. FOR FURTHER DETAILS REFER TO AVX SPECIFICATION 201-01-207.
3. ADDITIONAL INFORMATION AND BASIC MATING DETAILS REFER TO PAGES 12-13.
4. PACKING DETAILS ON PAGE 15.
5. CONNECTOR OUTLINE.

Two-Piece 4.0mm Pitch Battery

9155-400

3 WAY BATTERY CONNECTOR – FIXED HALF OPTIONAL



NOTES:

1. GENERAL TOLERANCE ± 0.20 UNLESS OTHERWISE STATED.
2. FOR FURTHER DETAILS REFER TO AVX SPECIFICATION 201-01-207.
3. ADDITIONAL INFORMATION AND BASIC MATING DETAILS REFER TO PAGES 12-13.
4. PACKING DETAILS ON PAGE 15.
5. CONNECTOR OUTLINE.

Two-Piece 4.0mm Pitch Battery

9155-400

4 WAY BATTERY CONNECTOR – FIXED HALF OPTIONAL

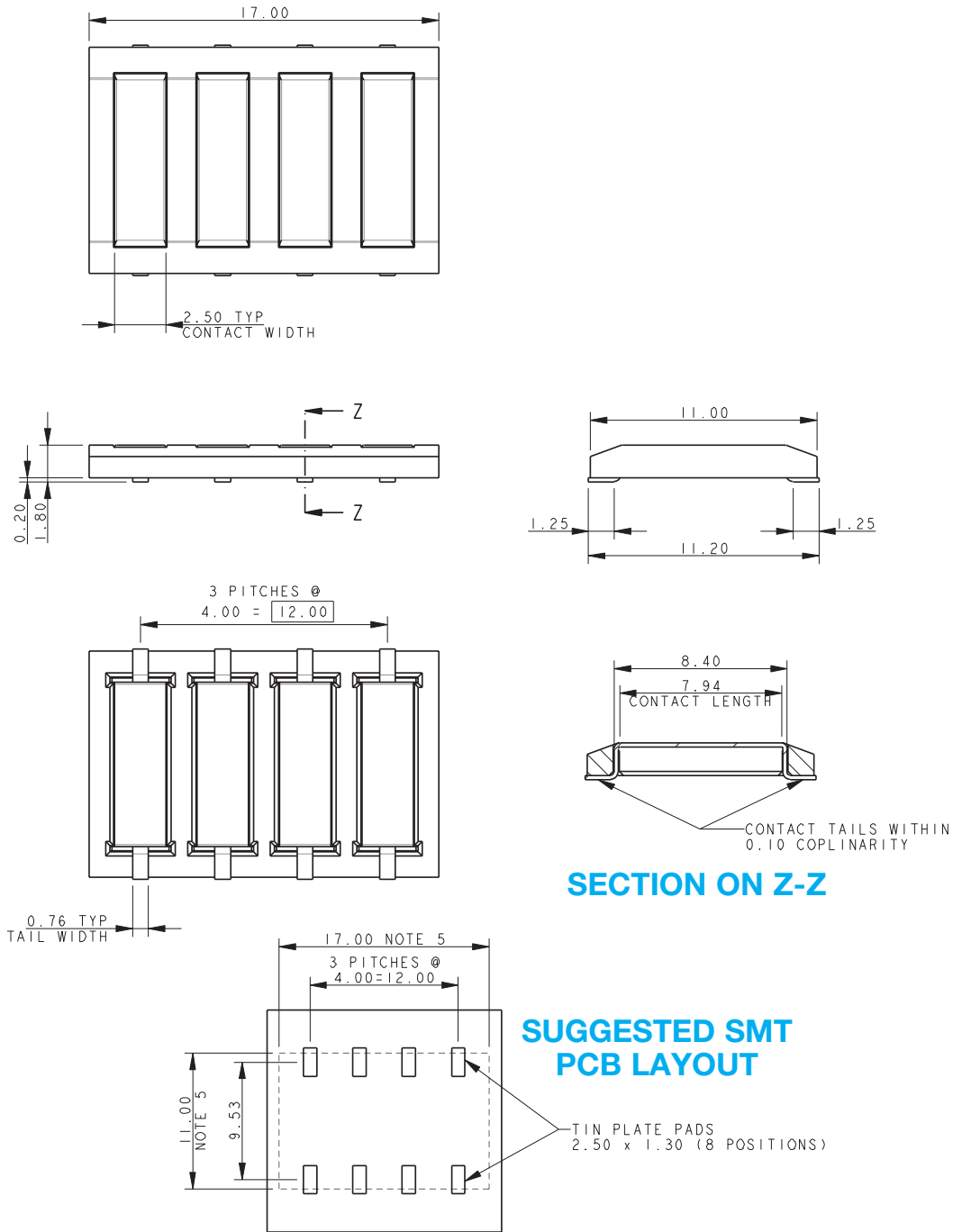

NOTES:

1. GENERAL TOLERANCE ± 0.20 UNLESS OTHERWISE STATED.
2. FOR FURTHER DETAILS REFER TO AVX SPECIFICATION 201-01-207.
3. ADDITIONAL INFORMATION AND BASIC MATING DETAILS REFER TO PAGES 12-13.
4. PACKING DETAILS ON PAGE 15.
5. CONNECTOR OUTLINE.

Two-Piece 4.0mm Pitch Battery

9155-400

5 WAY BATTERY CONNECTOR – FIXED HALF OPTIONAL



Two-Piece 4.0mm Pitch Battery

9155-400

6 WAY BATTERY CONNECTOR – FIXED HALF OPTIONAL

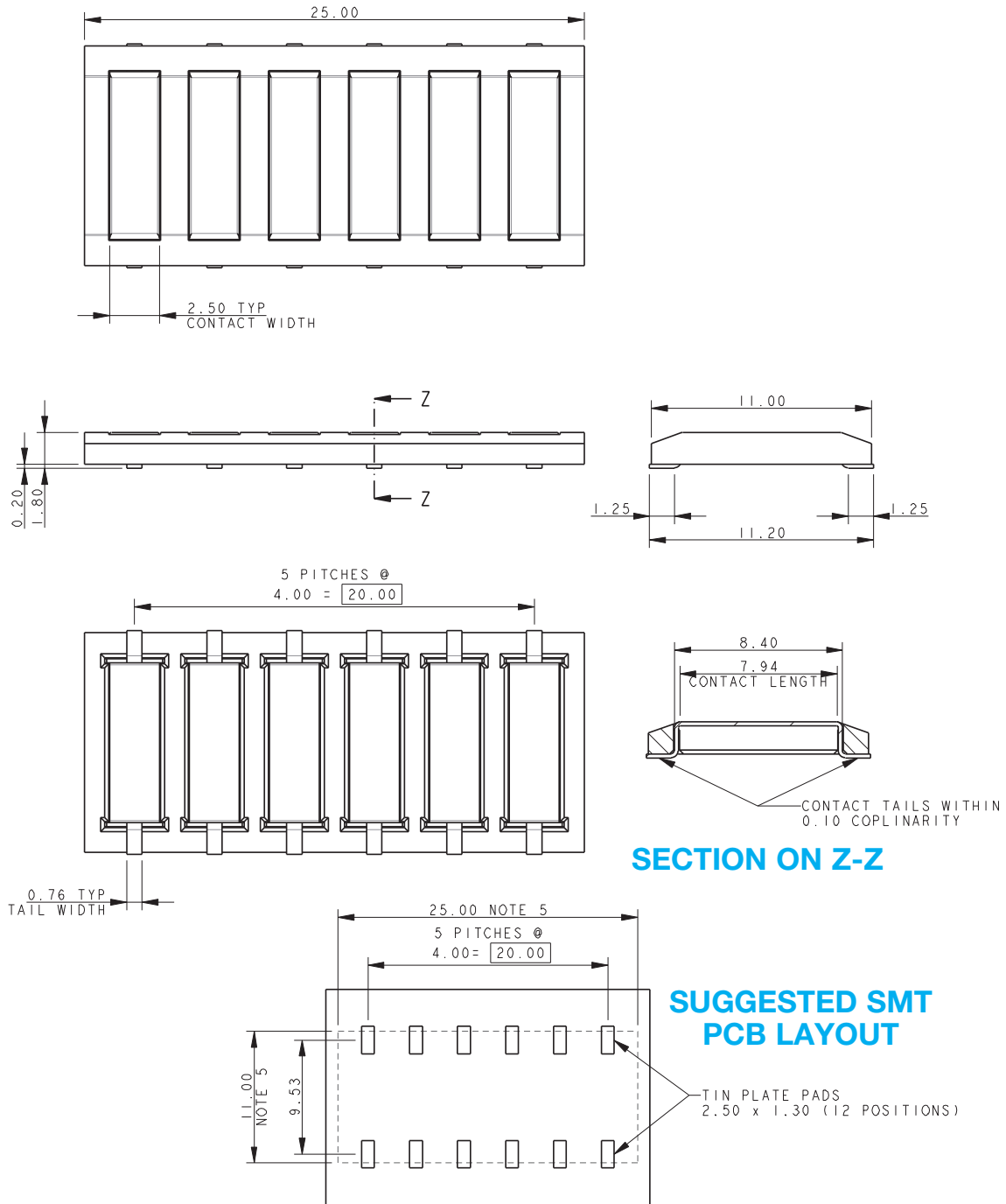

NOTES:

1. GENERAL TOLERANCE ± 0.20 UNLESS OTHERWISE STATED.
2. FOR FURTHER DETAILS REFER TO AVX SPECIFICATION 201-01-207.
3. ADDITIONAL INFORMATION AND BASIC MATING DETAILS REFER TO PAGES 12-13.
4. PACKING DETAILS ON PAGE 15.
5. CONNECTOR OUTLINE.

Two-Piece 4.0mm Pitch Battery

9155-400

BATTERY CONNECTOR - MATING DETAILS SPRUNG HALF MATED WITH FIXED HALF



CONNECTOR ASSEMBLY
MAXIMUM GAP

PROJECTED CONTACT FORCE 0.67N

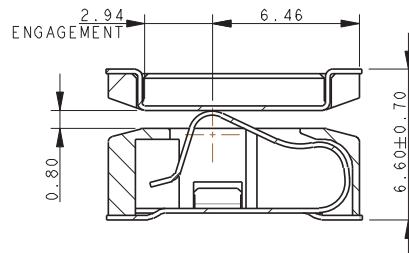

CONNECTOR ASSEMBLY
NOMINAL GAP

PROJECTED CONTACT FORCE 1.23N



CONNECTOR ASSEMBLY
MINIMUM GAP

PROJECTED CONTACT FORCE 1.70N

NOTES:

1. GENERAL TOLERANCE ± 0.20 UNLESS OTHERWISE STATED.
2. INSULATION MATERIAL: LCP, GLASS FILLED, UL94 V-0, COLOR BLACK.
3. CONTACT MATERIAL SPRUNG HALF: BERYLLIUM COPPER.
4. CONTACT MATERIAL FIXED HALF: PHOSPHOR BRONZE.
5. CONTACT PLATING: GOLD OVER NICKEL, PURE TIN TAILS.
6. DURABILITY 5000 OPERATIONS.
7. CURRENT RATING 5A.
8. CONTACT RESISTANCE 25m Ω MAX.

BATTERY CONNECTOR - MATING DETAILS DIRECTION OF MATING



VERTICAL MATING



HORIZONTAL MATING - FROM EITHER END

BATTERY CONNECTOR - MATING DETAILS SPRUNG HALF MATED WITH PCB

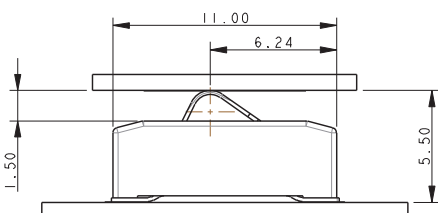

CONNECTOR ASSEMBLY
MAXIMUM GAP

PROJECTED CONTACT FORCE 0.67N

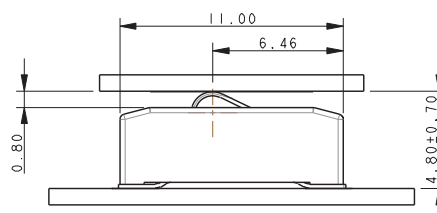

CONNECTOR ASSEMBLY
NOMINAL GAP

PROJECTED CONTACT FORCE 1.23N

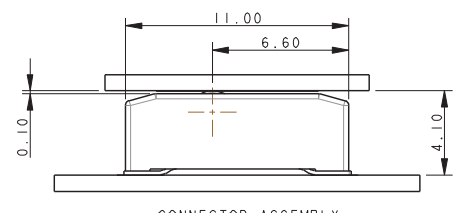

CONNECTOR ASSEMBLY
MINIMUM GAP

PROJECTED CONTACT FORCE 1.70N

NOTES:

1. GENERAL TOLERANCE ± 0.20 UNLESS OTHERWISE STATED.
2. SPRUNG HALF MATED WITH GOLD PLATED PAD ON PCB
3. VERTICAL MATING ONLY.

Two-Piece 4.0mm Pitch Battery

9155-400

BI-DIRECTIONAL BATTERY CONNECTOR - PACKING DETAILS

PACKING DETAILS SPRUNG CONNECTOR

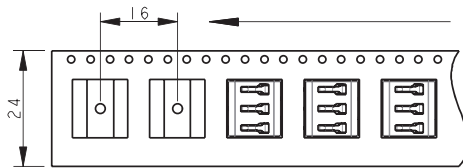

| | |
|----------|-------|
| REEL QTY | 550 |
| LEADER | 500mm |
| TRAILER | 500mm |

PACKING DETAILS FIXED CONNECTOR

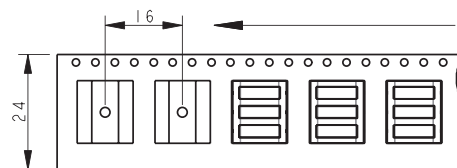

| | |
|----------|-------|
| REEL QTY | 1100 |
| LEADER | 500mm |
| TRAILER | 500mm |

UNREELED
DIRECTION



330mm DIAMETER REEL

Данный компонент на территории Российской Федерации

Вы можете приобрести в компании MosChip.

Для оперативного оформления запроса Вам необходимо перейти по данной ссылке:

<http://moschip.ru/get-element>

Вы можете разместить у нас заказ для любого Вашего проекта, будь то серийное производство или разработка единичного прибора.

В нашем ассортименте представлены ведущие мировые производители активных и пассивных электронных компонентов.

Нашей специализацией является поставка электронной компонентной базы двойного назначения, продукции таких производителей как XILINX, Intel (ex.ALTERA), Vicor, Microchip, Texas Instruments, Analog Devices, Mini-Circuits, Amphenol, Glenair.

Сотрудничество с глобальными дистрибьюторами электронных компонентов, предоставляет возможность заказывать и получать с международных складов практически любой перечень компонентов в оптимальные для Вас сроки.

На всех этапах разработки и производства наши партнеры могут получить квалифицированную поддержку опытных инженеров.

Система менеджмента качества компании отвечает требованиям в соответствии с ГОСТ Р ИСО 9001, ГОСТ РВ 0015-002 и ЭС РД 009

Офис по работе с юридическими лицами:

105318, г.Москва, ул.Щербаковская д.3, офис 1107, 1118, ДЦ «Щербаковский»

Телефон: +7 495 668-12-70 (многоканальный)

Факс: +7 495 668-12-70 (доб.304)

E-mail: info@moschip.ru

Skype отдела продаж:

moschip.ru

moschip.ru_4

moschip.ru_6

moschip.ru_9