

DATA SHEET

# SKY12241-492LF: 1.8 to 3.0 GHz 50 W Compact High-Power SPDT Switch with Integrated Driver

## Applications

- TDD 2G/3G/4G LTE systems
- High-power switch for micro-cell and macro-cell base stations
- Active antenna array

## Features

- Compact, integrated high-power switch with driver circuit
- Small PCB footprint with minimal external components
- Requires only a single +5 V DC supply, and a 0 to 3 V logic control
- Low TX/RX insertion loss: 0.29/0.52 dB @ 2.6 GHz
- High TX to RX isolation: 51 dB @ 2.6 GHz
- Low DC power consumption: <100 mA in TX or RX mode
- Small QFN (20-pin, 5 x 5 mm) Pb-free package (MSL3, 260 °C per JEDEC J-STD-020)



Skyworks Green™ products are compliant with all applicable legislation and are halogen-free. For additional information, refer to *Skyworks Definition of Green™*, document number SQ04-0074.

**Table 1. Pin-to-Pin Compatible High-Power SPDT Switches**

Part Number	Power Handling
SKY12241-492LF	50 W (CW)
SKY12242-492LF	100 W (CW)

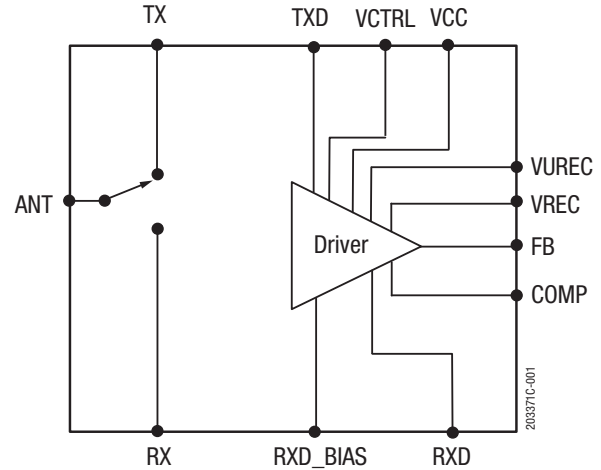

**Figure 1. SKY12241-492LF Block Diagram**

## Description

The SKY12241-492LF is a compact, integrated high-power single-pole, double-throw (SPDT) switch with driver circuit for TD-LTE applications. The part operates with a single +5 V supply and switches with a single control voltage (0 to 3 V).

This device features low TX and RX insertion loss, high isolation with low DC power consumption and requires minimal external components, enabling a smaller PCB footprint.

The device is provided in a 5 x 5 mm, 20-pin Quad Flat No-Lead (QFN) package. A functional block diagram is shown in Figure 1. The pin configuration and package are shown in Figure 2. Table 1 list the part numbers of pin-compatible parts belonging to this family of high-power SPDT switches. Signal pin assignments and functional pin descriptions are provided in Table 2.

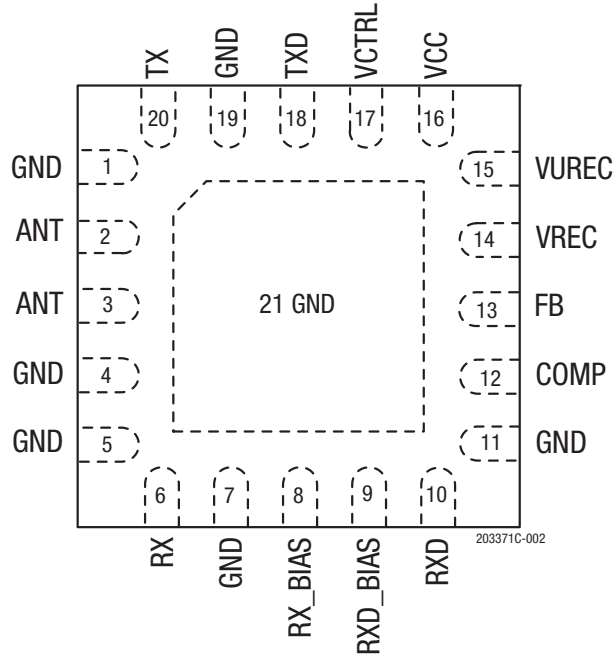

**Figure 2. SKY12241-492LF Pinout (Top View)**

**Table 2. SKY12241-492LF Signal Pin Descriptions**

Pin	Name	Function	Description
1, 4, 5, 7, 11, 19	GND	Ground	Ground. Must be connected to ground using lowest possible impedance.
2, 3	ANT	I/O	Antenna RF port and DC bias input port. RF input line must be connected to both pins.
6	RX	0	Receive RF output port and DC bias input port.
8	RX_BIAS	I	DC bias input port.
9	RXD_BIAS	0	Driver output voltage for switch RX_BIAS connection.
10	RXD	0	Driver output voltage for switch RX port.
12	COMP	0	Compensation pin of the internal boost converter.
13	FB	0	Feedback pin of the internal boost converter.
14	VREC	I	Rectified output voltage node of the internal boost converter.
15	VUREC	0	Unrectified output voltage node of the internal boost converter.
16	VCC	I	Input voltage for driver Vcc.
17	VCTRL	I	Switch control (0/3 V) (0 V for Receive mode, 3 V for Transmit mode).
18	TXD	0	Driver output pin for TX port DC bias connection.
20	TX	I	Transmit RF input port and DC bias input port.
21	GND	Ground	Ground. Refer to Figure 13 for optimum thermal performance.

## Electrical and Mechanical Specifications

The absolute maximum ratings of the SKY12241-492LF are provided in Table 3. Recommended operating conditions are specified in Table 4, DC characteristics in Table 5, and electrical specifications in Table 6. The state of the SKY12241-492LF is determined by the logic provided in Table 7.

Typical performance characteristics of the SKY12241-492LF are illustrated in Figures 3 through 6.

Power derating data is plotted against temperature in Figures 7 and 8.

**Table 3. SKY12241-492LF Absolute Maximum Ratings<sup>1</sup>  
(T<sub>CASE</sub> = 25 °C, Unless Otherwise Noted)**

Parameter	Symbol	Minimum	Maximum	Units
RF CW input power, TX port, TX mode (T <sub>CASE</sub> = 25 °C)	P <sub>IN</sub>		68	W
RF peak input power, TX port, TX mode (T <sub>CASE</sub> = 25 °C, LTE-TDD, 36 W average power, 8 dB PAR)	P <sub>IN</sub>		229	W
RF CW input power, ANT port, RX mode (T <sub>CASE</sub> = 25 °C)	P <sub>IN</sub>		5	W
RF peak input power, ANT port, RX mode (T <sub>CASE</sub> = 25 °C, LTE-TDD, 2.7 W average power, 8 dB PAR)	P <sub>IN</sub>		17	W
Module supply voltage	V <sub>CC</sub>		6	V
Logic control voltage	V <sub>CTRL</sub>	-0.5	+5.5	V
Operating temperature range <sup>2</sup>	T <sub>OP</sub>	-40	+105	°C
Storage temperature range	T <sub>STG</sub>	-55	+200	°C
Maximum junction temperature:	T <sub>J</sub>			
Diodes			+175	°C
Driver			+150	°C
Thermal resistance (T <sub>c</sub> = 85 °C)	θ <sub>Jc</sub>		33	°C/W
Electrostatic discharge:	ESD			
Charged Device Model (CDM), Class C3			1000	V
Human Body Model (HBM), Class 1C			500	V

<sup>1</sup> Exposure to maximum rating conditions for extended periods may reduce device reliability. There is no damage to device with only one parameter set at the limit and all other parameters set at or below their nominal value. Exceeding any of the limits listed here may result in permanent damage to the device.

<sup>2</sup> CW transmit power handling capability over temperature is shown in Figure 7 and Figure 8.

---

**ESD HANDLING:** *Although this device is designed to be as robust as possible, electrostatic discharge (ESD) can damage this device. This device must be protected at all times from ESD when handling or transporting. Static charges may easily produce potentials of several kilovolts on the human body or equipment, which can discharge without detection. Industry-standard ESD handling precautions should be used at all times.*

---

**Table 4. SKY12241-492LF Recommended Operating Conditions**

Parameter	Symbol	Min	Typ	Max	Units
Module supply voltage	V <sub>CC</sub>	4.5	5	5.5	V
Logic control voltage (low)	V <sub>CTRL_LOW</sub>	0	0	0.4	V
Logic control voltage (high)	V <sub>CTRL_HIGH</sub>	1.2	3	V <sub>CC</sub>	V

**Table 5. SKY12241-492LF DC Electrical Characteristics**

Parameter	Symbol	Min	Typ	Max	Units
Driver supply current TX Mode	I <sub>VCC</sub>		96		mA
Driver supply current RX Mode	I <sub>VCC</sub>		56		mA

**Table 6. SKY12241-492LF Electrical Specifications<sup>1</sup> (1 of 2)**

**(TCASE = +25 °C, Characteristic Impedance [Z<sub>0</sub>] = 50 Ω, as Measured on the Evaluation Board Optimized for 2.6 GHz Operation, Unless Otherwise Noted. Unused Port Terminated to 50 Ω)**

Parameter	Symbol	Test Condition	Min	Typ	Max	Units
Insertion loss, TX to ANT ports	IL <sub>TX-ANT</sub>	V <sub>CC</sub> = 5 V, V <sub>CTRL</sub> = 3 V (Tx mode), TX port input power (pin 20) = 0 dBm, measured at TX port		0.25	0.40	dB
Insertion loss, ANT to RX ports	IL <sub>ANT-RX</sub>	V <sub>CC</sub> = 5 V, V <sub>CTRL</sub> = 0 V (Rx mode), ANT port input power (pin 2, 3) = 0 dBm, measured at RX port		0.55	0.7	dB
Isolation, TX to RX ports	ISO <sub>TX-RX</sub>	V <sub>CC</sub> = 5 V, V <sub>CTRL</sub> = 3 V (Tx mode), TX port input power (pin 20) = 0 dBm measured at RX port	40	47		dB
Isolation, ANT to TX ports	ISO <sub>ANT-TX</sub>	V <sub>CC</sub> = 5 V, V <sub>CTRL</sub> = 0 V (Rx mode), ANT port input power (pin 3) = 0 dBm, measured at TX port	16	17		dB
Isolation, ANT to RX ports	ISO <sub>ANT-RX</sub>	V <sub>CC</sub> = 5 V, V <sub>CTRL</sub> = 3 V (Tx mode), ANT port input power (pin 2, 3) = 0 dBm, measured at RX port	40	42		dB
Input return loss	RL	TX Insertion loss state, TX Port (pin 20) V <sub>CC</sub> = 5 V, V <sub>CTRL</sub> = 3 V		20		dB
		RX Insertion loss state, ANT port (pin 2, 3) V <sub>CC</sub> = 5 V, V <sub>CTRL</sub> = 0 V		20		dB
Transmit 2 <sup>nd</sup> harmonic	2fo	TX Insertion loss state, TX port (pin 20) input power = +30 dBm, V <sub>CC</sub> = 5 V, V <sub>CTRL</sub> = 3 V		71		dBc
Transmit 3 <sup>rd</sup> harmonic	3fo	TX Insertion loss state, TX port input power (pin 20) = +30 dBm, V <sub>CC</sub> = 5 V, V <sub>CTRL</sub> = 3 V		92		dBc
Transmit input third order intercept point	IIP3	TX port input power (pin 20) = 30 dBm/tone, tone spacing = 1 MHz, V <sub>CC</sub> = 5 V, V <sub>CTRL</sub> = 3 V		+63		dBm
Transmit input power for 0.1 dB compression	TX_IP0.1dB	V <sub>CC</sub> = 5 V, V <sub>CTRL</sub> = 3 V		+47		dBm
Receive input power for 1.0 dB compression	RX_IP1.0dB	V <sub>CC</sub> = 5 V, V <sub>CTRL</sub> = 0 V		+38		dBm

**Table 6. SKY12241-492LF Electrical Specifications<sup>1</sup> (2 of 2)**

(TCASE = +25 °C, Characteristic Impedance [Z<sub>0</sub>] = 50 Ω, as Measured on the Evaluation Board Optimized for 2.6 GHz Operation, Unless Otherwise Noted. Unused Port Terminated to 50 Ω)

Parameter	Symbol	Test Condition	Min	Typ	Max	Units
Transmit RF rise time	TX_trISE	TX Mode; 10% RF power to 90% RF power at ANT output, V <sub>CC</sub> = 5 V, V <sub>CTRL</sub> = 0 to 3 V		272		ns
Transmit RF fall time	TX_tfALL	TX Mode; 90% RF power to 10% RF power at ANT output, V <sub>CC</sub> = 5 V, V <sub>CTRL</sub> = 3 to 0 V		142		ns
Transmit RF switch on time	TX_tON	TX Mode; 50% V <sub>CTRL</sub> signal to 90% RF power at ANT output port, V <sub>CC</sub> = 5 V, V <sub>CTRL</sub> = 0 to 3 V		912		ns
Transmit RF switch off time	TX_tOFF	TX Mode; 90% RF power to 50% V <sub>CTRL</sub> signal at ANT output port, V <sub>CC</sub> = 5 V, V <sub>CTRL</sub> = 3 to 0 V		444		ns
Receive RF rise time	RX_trISE	RX Mode; 10% RF power to 90% RF power at RX output, V <sub>CC</sub> = 5 V, V <sub>CTRL</sub> = 3 to 0 V		450		ns
Receive RF fall time	RX_tfALL	RX Mode; 90% RF power to 10% RF power at RX output, V <sub>CC</sub> = 5 V, V <sub>CTRL</sub> = 0 to 3 V		56		ns
Receive RF switch on time	RX_tON	RX Mode; 50% V <sub>CTRL</sub> signal to 90% RF power at RX output port, V <sub>CC</sub> = 5 V, V <sub>CTRL</sub> = 3 to 0 V		1260		ns
Receive RF switch off time	RX_tOFF	RX Mode; 90% RF power to 50% V <sub>CTRL</sub> signal at RX output port, V <sub>CC</sub> = 5 V, V <sub>CTRL</sub> = 0 to 3 V		256		ns

<sup>1</sup> Performance is guaranteed only under the conditions listed in this table.

**Table 7. SKY12241-492LF Truth Table (Voltages and Currents Are Controlled by Internal Driver Circuit. V<sub>CC</sub> = 5 V)**

Switch State	Path		Control Conditions				
	Antenna-to-Receiver Port (Pin 2/3 to Pin 6)	Transmitter-to-Antenna Port (Pin 20 to Pin 2/3)	Logic Control V <sub>CTRL</sub> (Pin 17)	Antenna Port Bias Input (Pins 2/3)	Transceiver Port Bias Input (Pin 20)	Receiver Port Bias Input (Pin 6)	RX_BIAS Bias Input (Pin 8)
Receive mode	Low insertion loss	High isolation	0 V	1 V	5 V (0 mA)	0 V (-50 mA)	0 V (0 mA)
Transmit mode	High isolation	Low insertion loss	3 V	1 V	0 V (-50 mA)	28 V (0 mA)	1 V (30 mA)

**Typical Performance Characteristics**

(T<sub>CASE</sub> = +25 °C, Characteristic Impedance [Z<sub>0</sub>] = 50 Ω, EVB Optimized for 1.8 to 3.0 GHz Operation, V<sub>CC</sub> = 5 V, Unless Otherwise Noted)

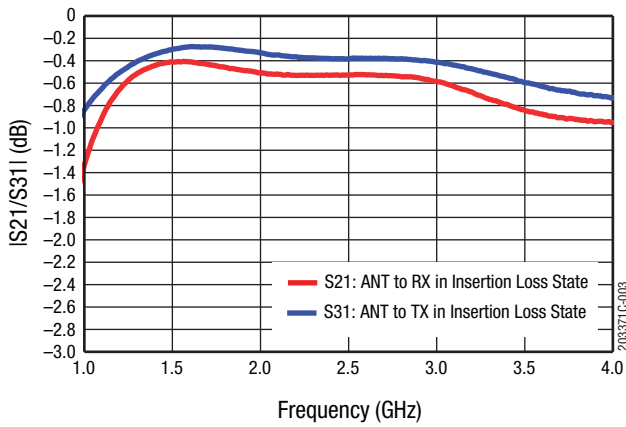

**Figure 3. Insertion Loss vs Frequency**

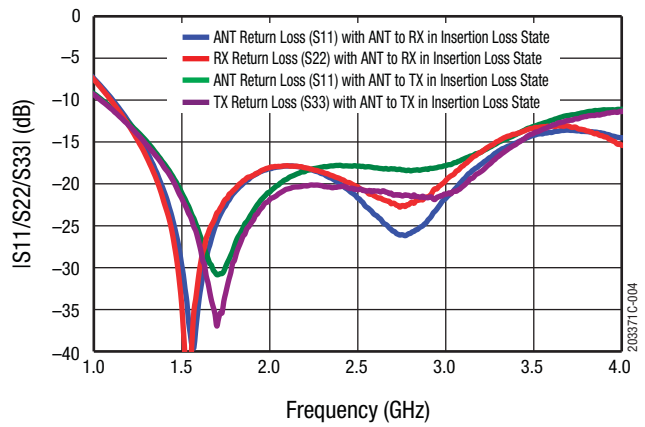

**Figure 4. Return Loss vs Frequency**

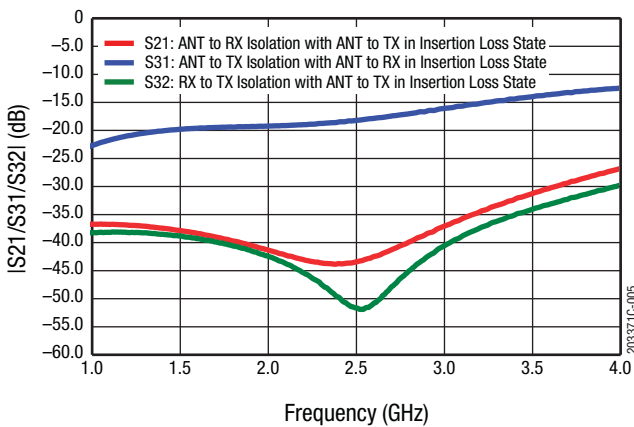

**Figure 5. Isolation vs Frequency**

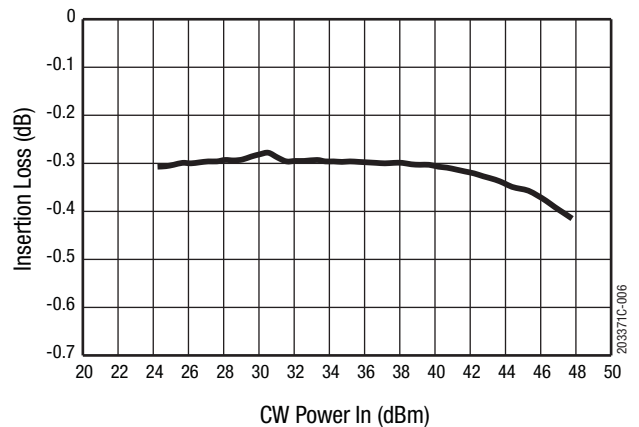

**Figure 6. Insertion Loss vs CW Input Power (ANT-TX, f = 2.6 GHz)**

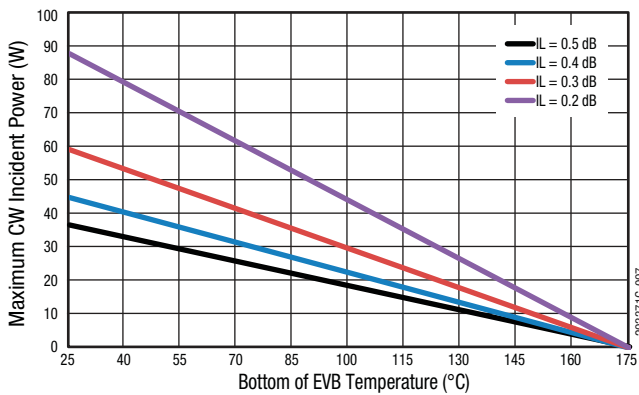

**Figure 7. Transmit Power Derating, Maximum CW Incident Power vs Bottom of EVB Temperature**

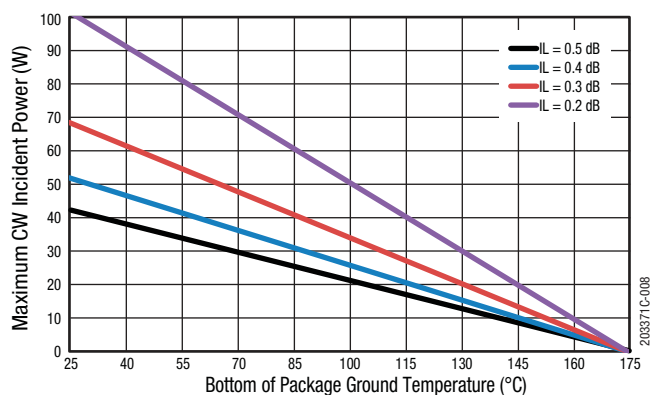

**Figure 8. Transmit Power Derating, Maximum CW Incident Power vs Bottom of Package Ground Temperature**

## Evaluation Board Description

The SKY12241-492LF Evaluation Board is used to test the performance of the SKY12241-492LF high-power SPDT switch

The SKY12241-492LF is designed to handle very large signals. Sufficient power may be dissipated by this switch to cause heating of the PIN diodes contained in the switch. It is very important to use a printed circuit board design that provides adequate grounding to facilitate thermal conduction allowing the PIN diodes to remain below their maximum rated junction temperature.

The transmit power derating curves referenced to the bottom of the QFN package are shown in Figure 7. A printed circuit board with a very low thermal resistance and external heat sink design must be used to achieve the results shown in this figure. The transmit power derating curve with the x-axis temperature referenced to the bottom of the printed circuit board is shown in Figure 8.

The evaluation circuit is designed to facilitate control of the SKY12241-492LF transmit/receive switch with a single TTL input. The state of the PIN diodes within the SKY12241-492LF with integrated driver is controlled with 5 V applied to VCC pin and either 3 V or 0 V applied to the VCTRL pin.

The value of resistor R4 (82  $\Omega$ ) is selected to provide 50 mA of forward current through the "on" series diode with 5 V applied to the ANT port bias pin. The R5 resistance value of 120  $\Omega$  is selected to produce approximately 30 mA of forward bias current in the RX shunt diode with a source voltage of 28 V.

The internal driver manages the voltages applied to the TX and RX ports to determine whether the RX or TX series diodes are biased into forward conduction. For example, with 3 V applied to VCTRL, the driver places the SKY12241-492LF into the transmit state by directing 0 V to the TX port (which forward-biases the diode between pins 2, 3 and 20), 28 V is applied to the RX port (which reverse-biases the diode between pins 2, 3 and 6), and 0 V is applied to the RX\_BIAS port (which applies a forward-bias through R5 to the diode connected between pins 6 and 8).

The switch external components were selected to optimize performance in the 1.8 to 3.0 GHz band. An Evaluation Board schematic diagram is shown in Figure 9. The Evaluation Board Bill of Materials is shown in Table 8. An assembly drawing for the Evaluation Board is shown in Figure 10. The board layer details are shown in Figure 11. The layer detail physical characteristics are provided in Figure 12.

## Recommended Evaluation Board Test Procedure

### *In Transmit Configuration:*

#### ***TX-ANT RF Path (Transmit Mode)***

1. With RF power OFF, connect the signal source to the TX port.
2. Connect a spectrum analyzer or power meter to the ANT port.
3. Terminate the RX-port with 50  $\Omega$ .
4. Apply +5 V to the VCC pin.
5. Set VCTRL to high.
6. Turn ON the RF power (TX port), and monitor the output signal at the ANT port.

### *For Shutdown:*

1. Turn OFF the RF power.
2. Turn OFF the VCC.
3. Turn OFF the VCTRL.

**Note:** *Shutdown is not always necessary. The SKY12241-492LF can be hot-switched without consequence.*

### *In Receive Configuration:*

#### ***ANT-RX RF Path (Receive Mode)***

1. With RF power OFF, connect the signal source to the ANT port.
2. Connect a spectrum analyzer or power meter to the RX port.
3. Terminate the TX-port with 50  $\Omega$
4. Apply +5 V to the VCC pin.
5. Set VCTRL to low.
6. Turn ON the RF power (ANT port), and monitor the output signal at the RX port.

### *For Shutdown:*

1. Turn OFF the RF power.
2. Turn OFF the VCC.
3. Turn OFF the VCTRL.

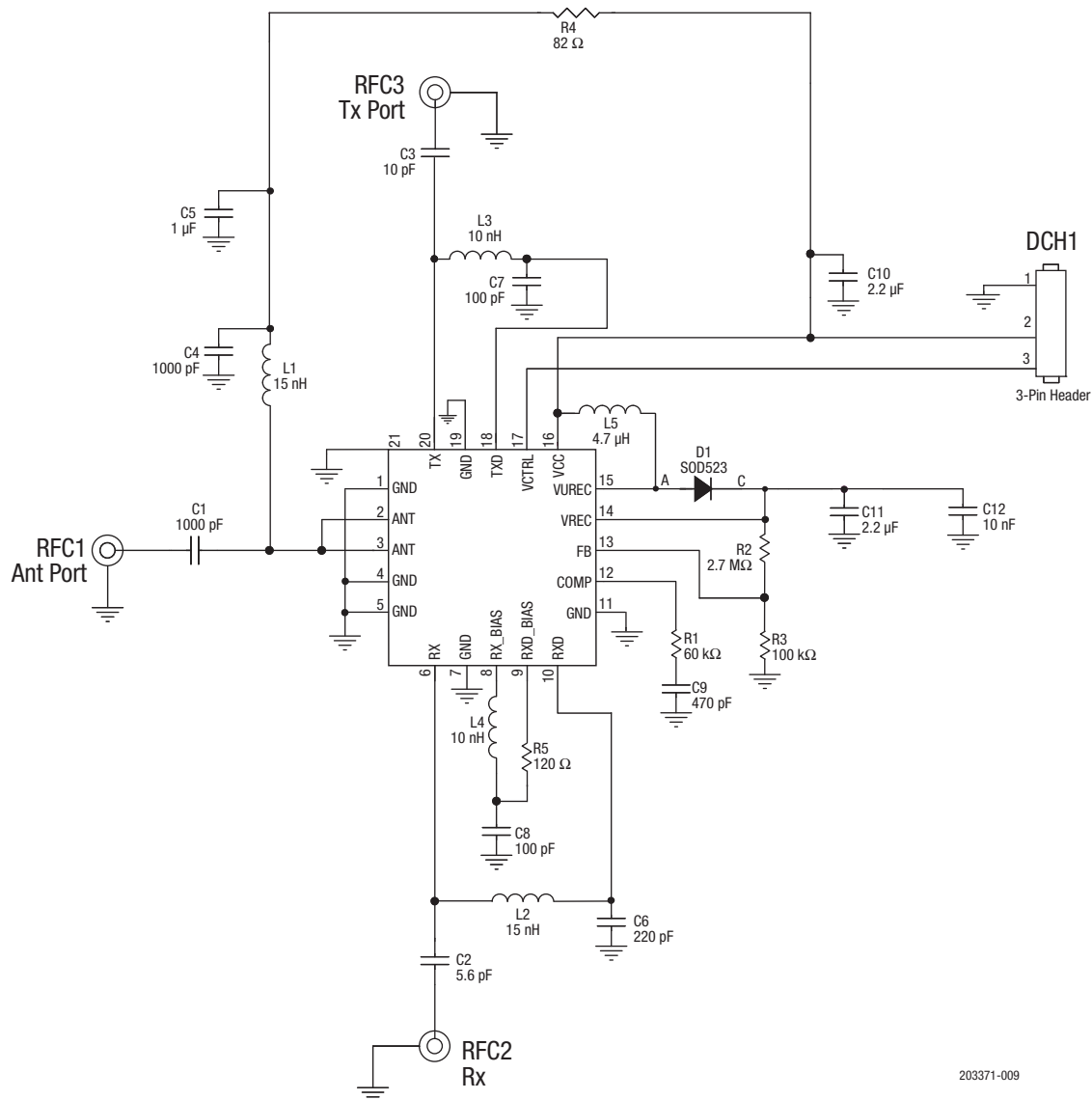

Figure 9. SKY12241-492LF Evaluation Board Schematic

203371-009



**Table 8. SKY12241-492LF Evaluation Board Bill of Materials (BOM)**

Component	Size	Manufacturer	Mfr Part Number	Description
C1	0603	Murata	GRM1887U1H102JA01J	Ceramic capacitor, 1000 pF, ±5%, U2J, 50 V
C2	0402	Murata	GRM1555C1H5R6CZ01	Ceramic capacitor, 5.6 pF, ±5%, COG, 50 V
C3	0402	Murata	GRM1555C1H100JZ01	Ceramic capacitor, 10 pF, ±5%, COG, 50 V
C4	0402	Murata	GRM1555C1H102JA01	Ceramic capacitor, 1000 pF, ±5%, COG, 50 V
C6	0402	Murata	GRM1555C1H221JA01	Ceramic capacitor, 220 pF, ±5%, COG, 50 V
C7, C8	0402	Murata	GRM1555C1H101JZ01	Ceramic capacitor, 100 pF, ±5%, COG, 50 V
C5	0402	Murata	GRM155R61C105KA12	Ceramic capacitor, 1 μF, ±10%, X5R, 16 V
L1, L2	0603	Murata	LQG18HN15NJ00D	Inductor, 15 nH, 600 mA, ±5%
L3, L4	0603	Murata	LQG18HN10NJ00D	Inductor, 10 nH, 650 mA, ±5%
R4	0805	ROhm	ESR10EZPJ820	Resistor, 82 Ω, 0.4 W, ±5%
R5	0805	ROhm	ESR10EZPJ121	Resistor, 120 Ω, 0.4 W, ±5%
C10	0402	Murata	GRM155R61C225KE11	Ceramic capacitor, 2.2 μF, ±10%, X5R, 16 V
C11	0603	Murata	GRM188R61H225KE11	Ceramic capacitor, 2.2 μF, ±10%, X5R, 50 V
C12	0402	Murata	GRM155B31H103KA88	Ceramic capacitor, 10 nF, ±10%, 50 V
R3	0402	Panasonic	ERJ2GEJ104	Resistor, 100 kΩ, 25 V, 0.063 W, ±5%
R2	0402	Panasonic	ERJ2GEJ275X	Resistor, 2.7 MΩ, 50 V, 0.10 W, ±5%
R1	0402	Panasonic	ERA2AEB6042X	Resistor, 60 kΩ, fixed, 0.063 W, ±5%
C9	0402	Murata	GRM155R71H471KA01	Ceramic capacitor, 470 pF, ±10%, 50 V
D1	1.6 x 0.8 x 0.6 mm	Diodes Inc.	SDM20U40	0.25 A low VF Schottky Diode SOD523
L5	2.5 x 2.0 x 1.2 mm	Murata	DFE252012P-4R7M	Power inductor, 4.7 μH, 1.4 A SMD

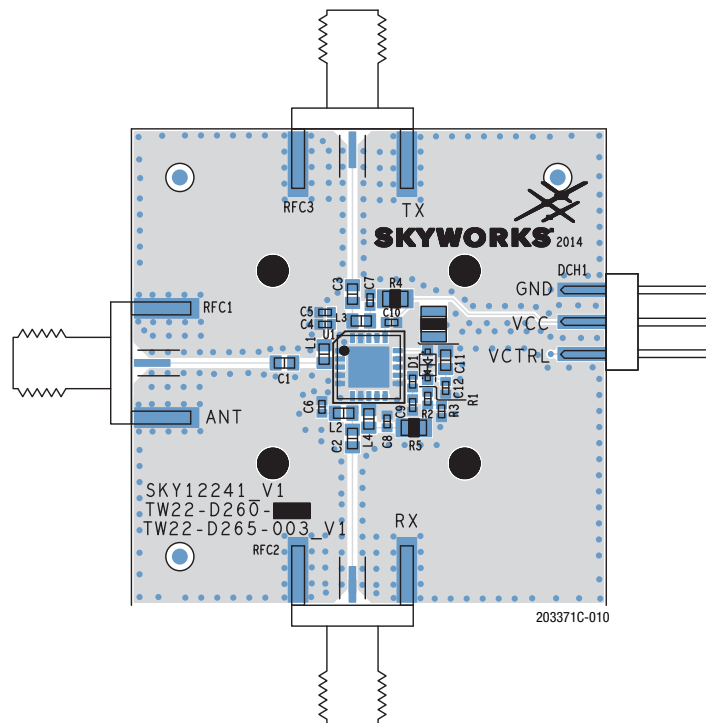

**Figure 10. SKY12241-492LF Evaluation Board Assembly Diagram**

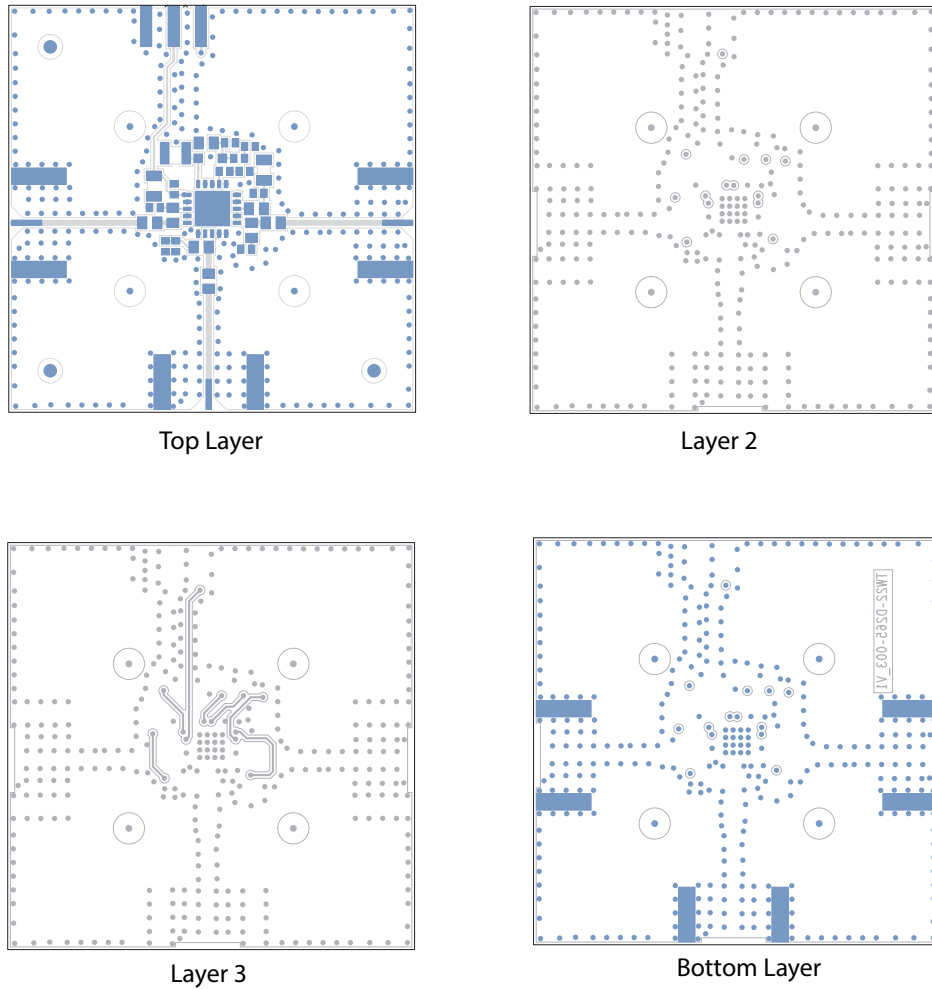

Figure 11. SKY12241-492LF Board Layer Detail

Cross Section	Name	Thickness (in)	Material
	Top Solder Mask		
	L1	(0.0028)	Cu foil
	Laminate	0.012 ± 0.0006	Rogers R04003C Core
	L2	(0.0014)	Cu foil
	Laminate	(Note 1)	FR4 Prepreg
	L3	(0.0014)	Cu foil
	Laminate	0.010 ± 0.0006	FR4 Core
	L4	(0.0028)	Cu foil
	Bottom Solder Mask		

Note 1: Adjust this thickness to meet total thickness goal of 0.062 ± 0.005 inch.

203371C-012

Figure 12. SKY12241-492LF Layer Detail Physical Characteristics

### Package Dimensions

The PCB layout footprint for the SKY12241-492LF is shown in Figure 13. Typical part markings are noted in Figure 14. Package dimensions are shown in Figure 15, and tape and reel dimensions are provided in Figure 16.

### Package and Handling Information

Since the device package is sensitive to moisture absorption, it is baked and vacuum packed before shipping. Instructions on the shipping container label regarding exposure to moisture after the container seal is broken must be followed. Otherwise, problems related to moisture absorption may occur when the part is subjected to high temperature during solder assembly.

The SKY12241-492LF is rated to Moisture Sensitivity Level 3 (MSL3) at 260 °C. It can be used for lead or lead-free soldering. For additional information, refer to the Skyworks Application Note, *Solder Reflow Information*, document number 200164.

Care must be taken when attaching this product, whether it is done manually or in a production solder reflow environment. Production quantities of this product are shipped in a standard tape and reel format.

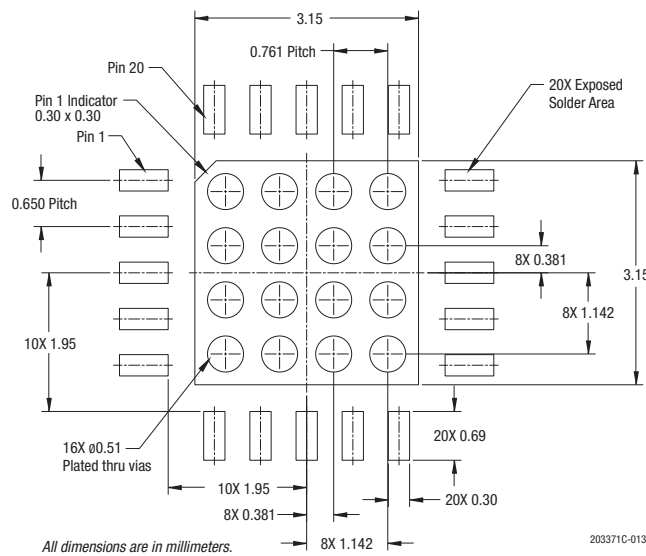

Figure 13. PCB Layout Footprint

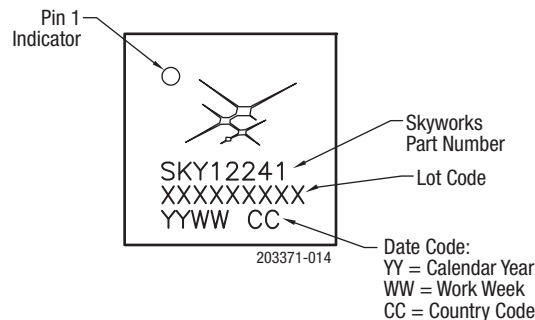
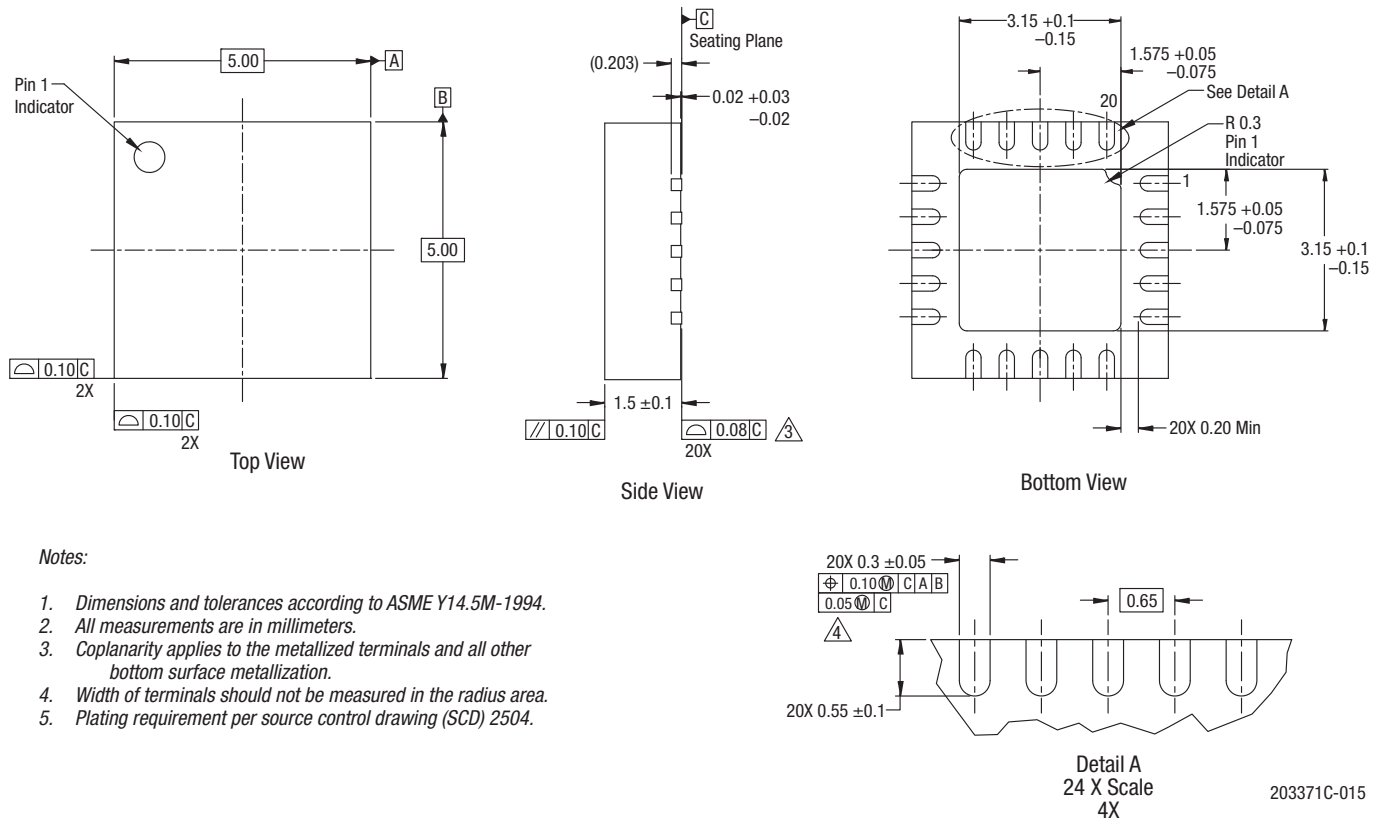

Figure 14. Typical Part Markings (Top View)

**DATA SHEET • SKY12241-492LF: 50 W COMPACT HIGH-POWER SPDT SWITCH WITH INTEGRATED DRIVER**



**Notes:**

1. Dimensions and tolerances according to ASME Y14.5M-1994.
2. All measurements are in millimeters.
3. Coplanarity applies to the metallized terminals and all other bottom surface metallization.
4. Width of terminals should not be measured in the radius area.
5. Plating requirement per source control drawing (SCD) 2504.

**Figure 15. SKY12241-492LF Package Dimensions**

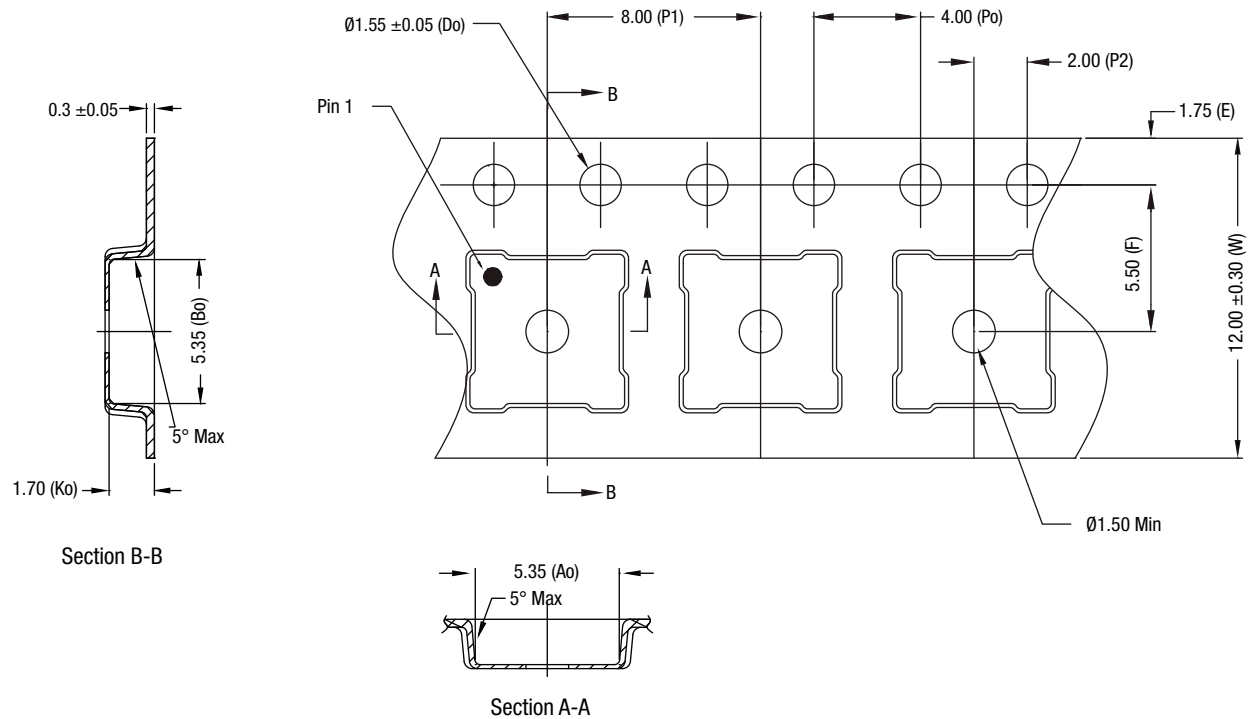

Notes:

1. Carrier tapes must meet all requirements of Skyworks GP01-D233 procurement spec for tape and reel shipping.
2. Carrier tape shall be black conductive polystyrene.
3. Cover tape shall be transparent conductive material.
4. ESD-surface resistivity shall be  $\leq 1 \times 10^{10}$  Ohms/square per EIA, JEDEC TNR specification.
5. P0/P1 10 pitches cumulative tolerance on tape:  $\pm 0.20$  mm.
6. Ao & Bo measurement point to be 0.30 mm from bottom pocket.
7. All dimensions are in millimeters.

203371C-016

Figure 16. SKY12241-492LF Tape and Reel Dimensions

## Ordering Information

Part Number	Product Description	Evaluation Board Part Number
SKY12241-492LF	50 W Compact High-Power SPDT Switch	SKY12241-492LF-EVB

Copyright © 2014-2018 Skyworks Solutions, Inc. All Rights Reserved.

Information in this document is provided in connection with Skyworks Solutions, Inc. (“Skyworks”) products or services. These materials, including the information contained herein, are provided by Skyworks as a service to its customers and may be used for informational purposes only by the customer. Skyworks assumes no responsibility for errors or omissions in these materials or the information contained herein. Skyworks may change its documentation, products, services, specifications or product descriptions at any time, without notice. Skyworks makes no commitment to update the materials or information and shall have no responsibility whatsoever for conflicts, incompatibilities, or other difficulties arising from any future changes.

No license, whether express, implied, by estoppel or otherwise, is granted to any intellectual property rights by this document. Skyworks assumes no liability for any materials, products or information provided hereunder, including the sale, distribution, reproduction or use of Skyworks products, information or materials, except as may be provided in Skyworks Terms and Conditions of Sale.

THE MATERIALS, PRODUCTS AND INFORMATION ARE PROVIDED “AS IS” WITHOUT WARRANTY OF ANY KIND, WHETHER EXPRESS, IMPLIED, STATUTORY, OR OTHERWISE, INCLUDING FITNESS FOR A PARTICULAR PURPOSE OR USE, MERCHANTABILITY, PERFORMANCE, QUALITY OR NON-INFRINGEMENT OF ANY INTELLECTUAL PROPERTY RIGHT; ALL SUCH WARRANTIES ARE HEREBY EXPRESSLY DISCLAIMED. SKYWORKS DOES NOT WARRANT THE ACCURACY OR COMPLETENESS OF THE INFORMATION, TEXT, GRAPHICS OR OTHER ITEMS CONTAINED WITHIN THESE MATERIALS. SKYWORKS SHALL NOT BE LIABLE FOR ANY DAMAGES, INCLUDING BUT NOT LIMITED TO ANY SPECIAL, INDIRECT, INCIDENTAL, STATUTORY, OR CONSEQUENTIAL DAMAGES, INCLUDING WITHOUT LIMITATION, LOST REVENUES OR LOST PROFITS THAT MAY RESULT FROM THE USE OF THE MATERIALS OR INFORMATION, WHETHER OR NOT THE RECIPIENT OF MATERIALS HAS BEEN ADVISED OF THE POSSIBILITY OF SUCH DAMAGE.

Skyworks products are not intended for use in medical, lifesaving or life-sustaining applications, or other equipment in which the failure of the Skyworks products could lead to personal injury, death, physical or environmental damage. Skyworks customers using or selling Skyworks products for use in such applications do so at their own risk and agree to fully indemnify Skyworks for any damages resulting from such improper use or sale.

Customers are responsible for their products and applications using Skyworks products, which may deviate from published specifications as a result of design defects, errors, or operation of products outside of published parameters or design specifications. Customers should include design and operating safeguards to minimize these and other risks. Skyworks assumes no liability for applications assistance, customer product design, or damage to any equipment resulting from the use of Skyworks products outside of stated published specifications or parameters.

Skyworks and the Skyworks symbol are trademarks or registered trademarks of Skyworks Solutions, Inc. or its subsidiaries in the United States and other countries. Third-party brands and names are for identification purposes only, and are the property of their respective owners. Additional information, including relevant terms and conditions, posted at [www.skyworksinc.com](http://www.skyworksinc.com), are incorporated by reference.

## Данный компонент на территории Российской Федерации

### Вы можете приобрести в компании MosChip.

Для оперативного оформления запроса Вам необходимо перейти по данной ссылке:

<http://moschip.ru/get-element>

Вы можете разместить у нас заказ для любого Вашего проекта, будь то серийное производство или разработка единичного прибора.

В нашем ассортименте представлены ведущие мировые производители активных и пассивных электронных компонентов.

Нашей специализацией является поставка электронной компонентной базы двойного назначения, продукции таких производителей как XILINX, Intel (ex.ALTERA), Vicor, Microchip, Texas Instruments, Analog Devices, Mini-Circuits, Amphenol, Glenair.

Сотрудничество с глобальными дистрибьюторами электронных компонентов, предоставляет возможность заказывать и получать с международных складов практически любой перечень компонентов в оптимальные для Вас сроки.

На всех этапах разработки и производства наши партнеры могут получить квалифицированную поддержку опытных инженеров.

Система менеджмента качества компании отвечает требованиям в соответствии с ГОСТ Р ИСО 9001, ГОСТ РВ 0015-002 и ЭС РД 009

### Офис по работе с юридическими лицами:

105318, г.Москва, ул.Щербаковская д.3, офис 1107, 1118, ДЦ «Щербаковский»

Телефон: +7 495 668-12-70 (многоканальный)

Факс: +7 495 668-12-70 (доб.304)

E-mail: [info@moschip.ru](mailto:info@moschip.ru)

Skype отдела продаж:

moschip.ru

moschip.ru\_4

moschip.ru\_6

moschip.ru\_9