

SF2037B-2

76.500 MHz SAW Filter

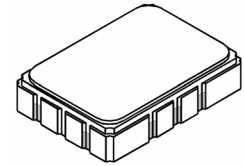

SMP-03

- *Designed for SDARS IF Receiver*
- *Low Insertion Loss*
- *5.0 X 7.0 mm Surface-Mount Case*
- *Differential or Single Ended Input and Output*

Absolute Maximum Ratings

Rating	Value	Units
Maximum Incident Power in Passband	+10	dBm
Max. DC voltage between any 2 terminals	30	VDC
Storage Temperature Range (with tape & reel)	-40 to +85	°C
Storage Temperature Range (without tape & reel)	-50 to +125	°C
Max Soldering Profile	265°C for 10 s	

Electrical Characteristics

Characteristic	Sym	Notes	Min	Typ	Max	Units		
Nominal Center Frequency	f_c	1	76.500			MHz		
Passband	Insertion Loss	IL	3.8	10.0	12.5	dB		
				1dB Passband	BW ₁	4.1		MHz
				15dB Bandwidth	BW ₁₅	6.7	6.8	MHz
				30dB Bandwidth	BW ₃₀	7.7	7.8	MHz
Amplitude Ripple over $f_c \pm 1.9$ MHz				0.5	1.10	dB _{P-P}		
Group Delay Variation over $f_c \pm 1.9$ MHz		GDV		65	150	ns _{P-P}		
Rejection	50 to 70.44 MHz	1, 3	37	43		dB		
			70.44 to 72.04 MHz	34	43			
			81.26 to 82.56 MHz	38	49			
			82.56 to 86.50 MHz	39	48			
			86.5 to 91.50 MHz	41	48			
			91.50 to 100.000 MHz	45	58			
Operating Temperature Range	T _A	1	-40		+105	°C		
Frequency Temperature Coefficient	FTC			-18		ppm/°C		
Differential Input	175 ohms							
Differential Output	1000 ohms							
Case Style	SMP-03 7 x 5 mm Nominal Footprint							
Lid Symbolization (YY=year, WW=week, S=shift) See note 4	RFM SF2037B-2 YYWWS							

Electrical Connections

Connection	Terminals
Port 1 Hot	10
Port 1 Ground Return	1
Port 2 Hot	5
Port 2 Ground Return	6
Case Ground	All Others



CAUTION: Electrostatic Sensitive Device. Observe precautions for handling.

NOTES:

1. Unless noted otherwise, all specifications apply over the operating temperature range with filter soldered to the specified demonstration board with impedance matching to 50 Ω and measured with 50 Ω network analyzer.
2. Unless noted otherwise, all frequency specifications are referenced to the nominal center frequency, f_c .
3. Rejection is measured as attenuation below the minimum IL point in the passband. Rejection in final user application is dependent on PCB layout and external impedance matching design. See Application Note No. 42 for details.
4. "LRIP" or "L" after the part number indicates "low rate initial production" and "ENG" or "E" indicates "engineering prototypes."
5. The design, manufacturing process, and specifications of this filter are subject to change.
6. Tape and Reel Standard ANSI / EIA 481.
7. Either Port 1 or Port 2 may be used for either input or output in the design. However, impedances and impedance matching may vary between Port 1 and Port 2, so that the filter must always be installed in one direction per the circuit design.
8. US and international patents may apply.
9. Murata, stylized Murata logo, and Murata N.A., Inc. are registered trademarks of Murata Manufacturing Co., Ltd.

Matching Circuit and Matching Component Values Used in G3 Sirius Radios

(Refer to Sirius Radio G3 Chipset Application Note, Doc. #RX000104-B, Sec. 4.2.4)

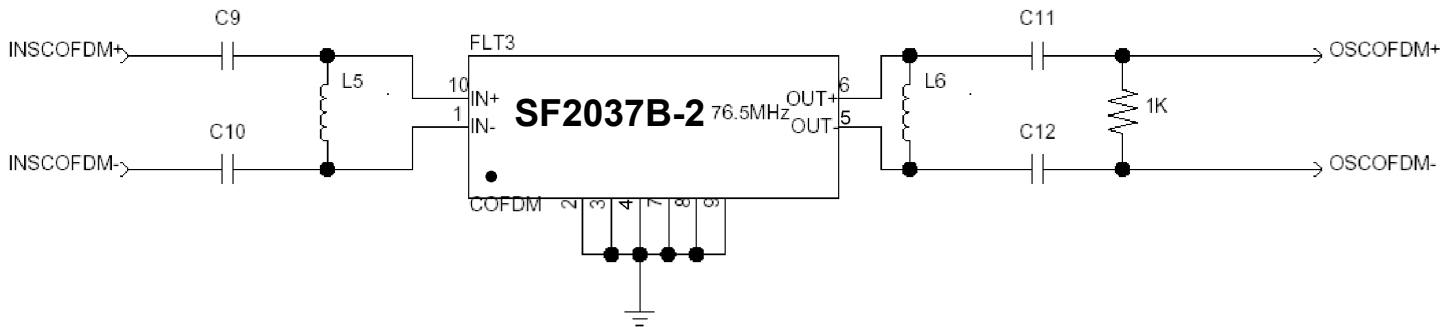

COFDM Narrowband SAW Matching Circuit

COFDM Narrowband SAW Matching Values

Reference Designator	Value
C9	10 pF
C10	10 pF
L5	270 nH
L6	390 nH
C11	100 pF
C12	100 pF

Matching Circuit and Matching Component Values Used on Filter Demo Board

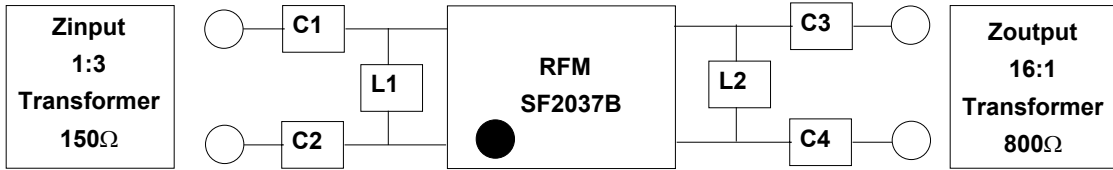

SF2037B
76.500 MHz

C1 = 9pF
C2 = 9pF
L1 = 270nH
L2 = 330nH
C3 = 18pF
C4 = 18pF

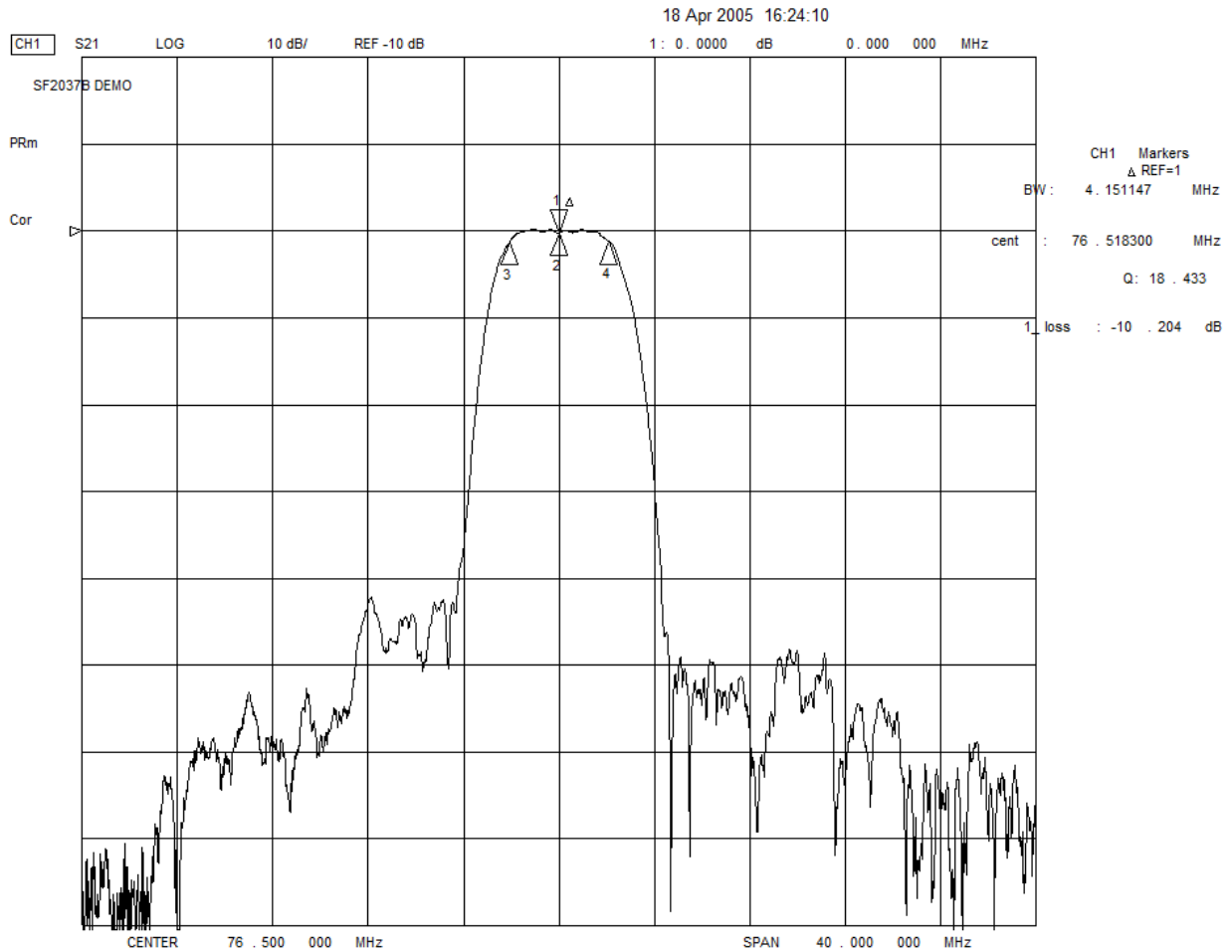

18 Apr 2005 16:18:31

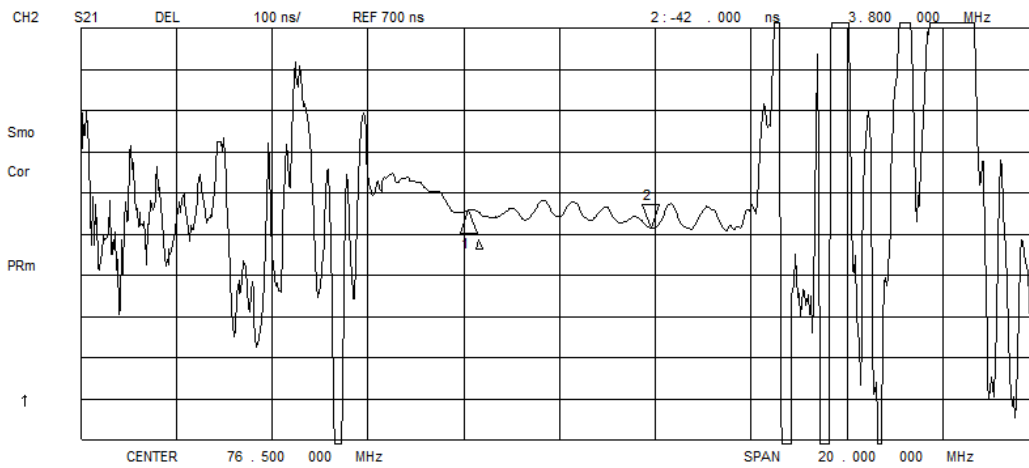
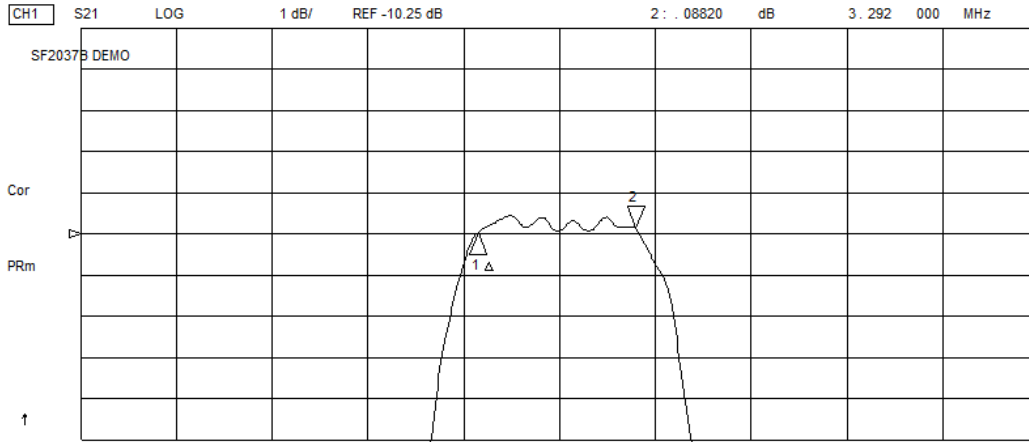

18 Apr 2005 16:28:43

CH1 S11 1 UFS

1: 59.928 Ω -9.8086 Ω 212.11 pF 76.500 000 MHz

SF2037B DEMO

Cor

PRm

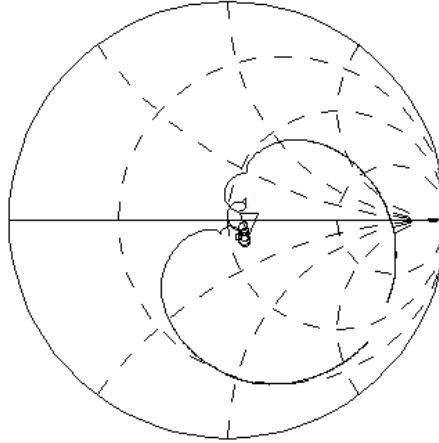

CH2 S22 1 UFS

1: 43.949 Ω 3.1992 Ω 6.6558 nH 76.500 000 MHz

Cor

PRm

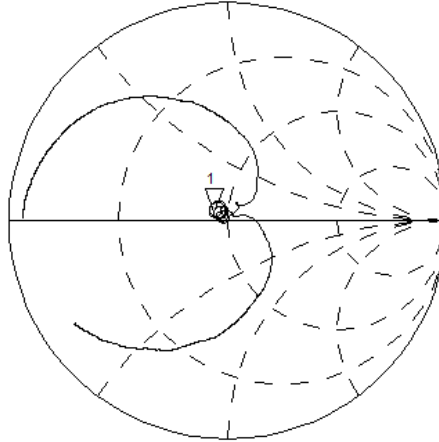

CENTER 76.500 000 MHz

SPAN 40.000 000 MHz

SMP-03 Case

10-Terminal Ceramic Surface-Mount Case

7 x 5 mm Nominal Footprint

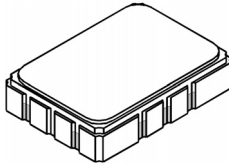

Recommended PCB Footprint

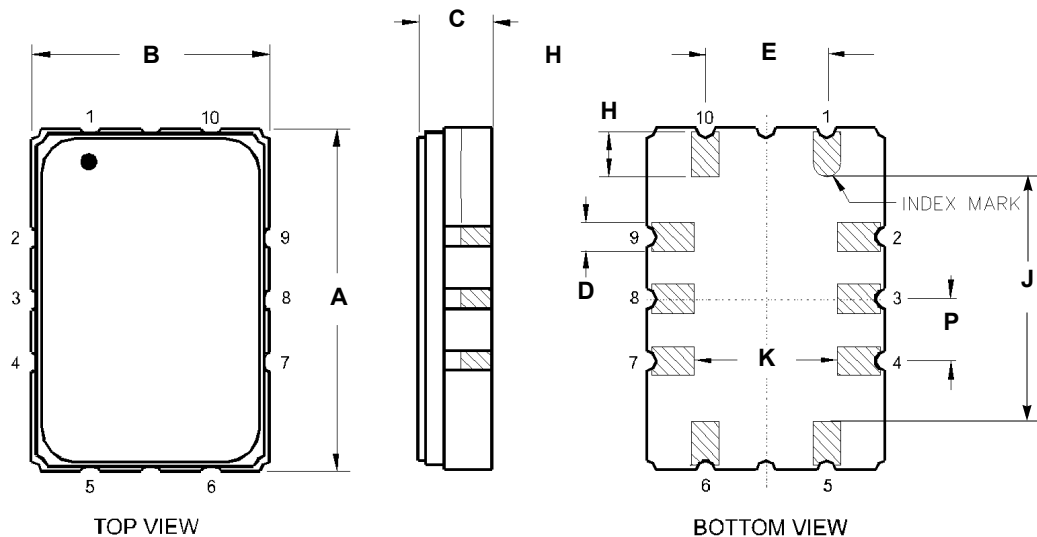
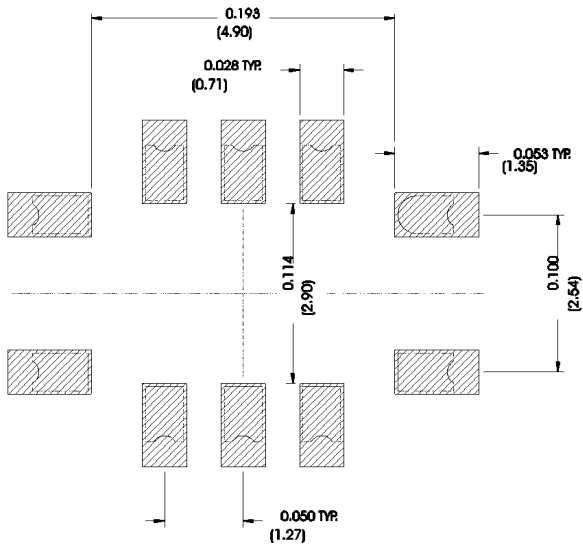

Case Dimensions

Dimension	mm			Inches		
	Min	Nom	Max	Min	Nom	Max
A	6.80	7.00	7.20	0.268	0.276	0.283
B	4.80	5.00	5.20	0.189	0.197	0.205
C		1.65	2.00		0.065	0.079
D	.47	0.60	.73	0.019	0.024	0.029
E	2.41	2.54	2.67	0.095	0.100	0.105
H	0.87	1.0	1.13	0.034	0.039	0.044
J	4.87	5.00	5.13	0.192	0.197	0.202
K	2.87	3.00	3.13	0.113	0.118	0.123
P	1.14	1.27	1.40	0.045	0.050	0.055

Materials

Solder Pad Termination	Au plating 30 - 60 ulnches (76.2-152 uM) over 80-200 ulnches (203-508 uM) Ni.
Lid	Fe-Ni-Co Alloy Electroless Nickel Plate (8-11% Phosphorus) 100-200 ulnches Thick
Body	Al ₂ O ₃ Ceramic
Pb Free	

Electrical Connections

Connection		Terminals
Port 1	Input or Return	10
	Return or Input	1
Port 2	Output or Return	5
	Return or Output	6
Ground		All others
Single Ended Operation		Return is ground
Differential Operation		Return is hot

Tape and Reel Specifications

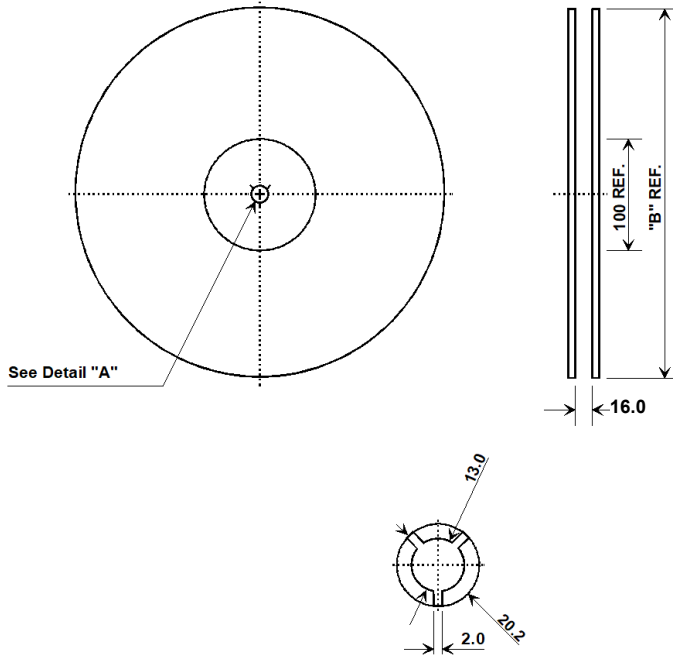

"B" Nominal Size		Quantity Per Reel
Inches	millimeters	
7	178	500
13	330	2000

Product Reflow/ESD/MSL

Reflow Peak Temperature	265	°C
Reflow Peak Time	10	Seconds
Liquidus 217 Temperature/Time	110	Seconds
Over Liquidus 230 Temperature/Time	70	Seconds
Reflow Condition	SMT	
Class Level HBM	2	
HBM(V)	2000	HBM(V)
MM(V)	N/A	MM(V)
CDM(V)	2000	CDM(V)
MSL	1	

COMPONENT ORIENTATION and DIMENSIONS

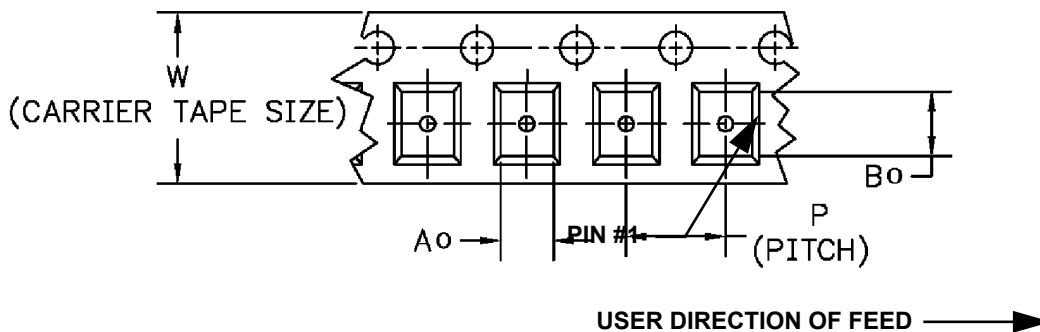
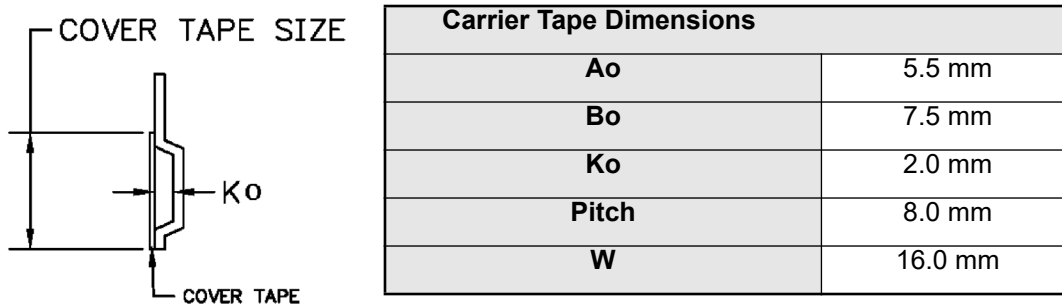

Данный компонент на территории Российской Федерации

Вы можете приобрести в компании MosChip.

Для оперативного оформления запроса Вам необходимо перейти по данной ссылке:

<http://moschip.ru/get-element>

Вы можете разместить у нас заказ для любого Вашего проекта, будь то серийное производство или разработка единичного прибора.

В нашем ассортименте представлены ведущие мировые производители активных и пассивных электронных компонентов.

Нашей специализацией является поставка электронной компонентной базы двойного назначения, продукции таких производителей как XILINX, Intel (ex.ALTERA), Vicor, Microchip, Texas Instruments, Analog Devices, Mini-Circuits, Amphenol, Glenair.

Сотрудничество с глобальными дистрибьюторами электронных компонентов, предоставляет возможность заказывать и получать с международных складов практически любой перечень компонентов в оптимальные для Вас сроки.

На всех этапах разработки и производства наши партнеры могут получить квалифицированную поддержку опытных инженеров.

Система менеджмента качества компании отвечает требованиям в соответствии с ГОСТ Р ИСО 9001, ГОСТ РВ 0015-002 и ЭС РД 009

Офис по работе с юридическими лицами:

105318, г.Москва, ул.Щербаковская д.3, офис 1107, 1118, ДЦ «Щербаковский»

Телефон: +7 495 668-12-70 (многоканальный)

Факс: +7 495 668-12-70 (доб.304)

E-mail: info@moschip.ru

Skype отдела продаж:

moschip.ru

moschip.ru_4

moschip.ru_6

moschip.ru_9