

Opto Interrupter ITR9909

Features

- Fast response time
- High analytic
- Cut-off visible wavelength $\lambda_p=940\text{nm}$
- High sensitivity
- Pb free
- This product itself will remain within RoHS compliant version

Description

- The ITR9909 consist of an infrared emitting diode and an NPN silicon phototransistor, encased side-by-side on converging optical axis in a black thermoplastic housing,
- The phototransistor receives radiation from the IR only .This is the normal situation.
- But when an object is in between , phototransistor could not receives the radiation.
- For additional component information , please refer to IR and PT

Applications

- Mouse Copier
- Switch Scanner
- Floppy disk driver
- Non-contact Switching
- For Direct Board

Device Selection Guide

Device No.	Chip Materials	Lens Color
IR	GaAlAs	Blue
PT	Silicon	Black

Absolute Maximum Ratings (Ta=25 °C)

Parameter		Symbol	Ratings	Unit
Input	Power Dissipation at(or below) 25 °C Free Air Temperature	Pd	75	mW
	Reverse Voltage	V _R	5	V
	Forward Current	I _F	50	mA
	Peak Forward Current (*1) Pulse width 100µs, Duty cycle=1%	I _{FP}	1	A
Output	Collector Power Dissipation	Pd	75	mW
	Collector Current	I _C	50	mA
	Collector-Emitter Voltage	B V _{CEO}	30	V
	Emitter-Collector Voltage	B V _{ECO}	5	V
Operating Temperature		T _{opr}	-25~+85	
Storage Temperature		T _{stg}	-40~+85	
Lead Soldering Temperature (*2) (1/16 inch form body for 5 seconds)		T _{sol}	260	

(*1) $t_w=100 \mu\text{sec.}$, $T=10 \text{ msec.}$ (*2) $t=5 \text{ Sec}$

Electro-Optical Characteristics (Ta=25)

Parameter		Symbol	Min.	Typ.	Max.	Unit	Conditions
Input	Forward Voltage	VF	---	1.2	1.5	V	IF=20mA
			---	1.4	1.85		IF=100mA, tp=100 μ s, tp/T=0.01
			---	2.6	4.0		IF=1A, tp=100 μ s, tp/T=0.01
	Reverse Current	IR	---	---	10	μA	VR=5V
	Peak Wavelength	λP	---	940	---	nm	IF=20mA
Output	Dark C urrent	ICEO	---	---	100	nA	VCE=20V, Ee=0mW/cm ²
	C-E Saturation Voltage	VCE(sat)	---	---	0.4	V	IC=2mA Ee=1mW/cm ²
Transfer Characteristics	Collect Current	IC(ON)	200	---	---	uA	VCE=5V IF=20mA
	Rise time	tr	---	15	---	μsec	VCE=5V, IC=1mA ,RL=1000Ω
	Fall time	tf	---	15	---	μsec	

Typical Electrical/Optical/Characteristics Curves for IR

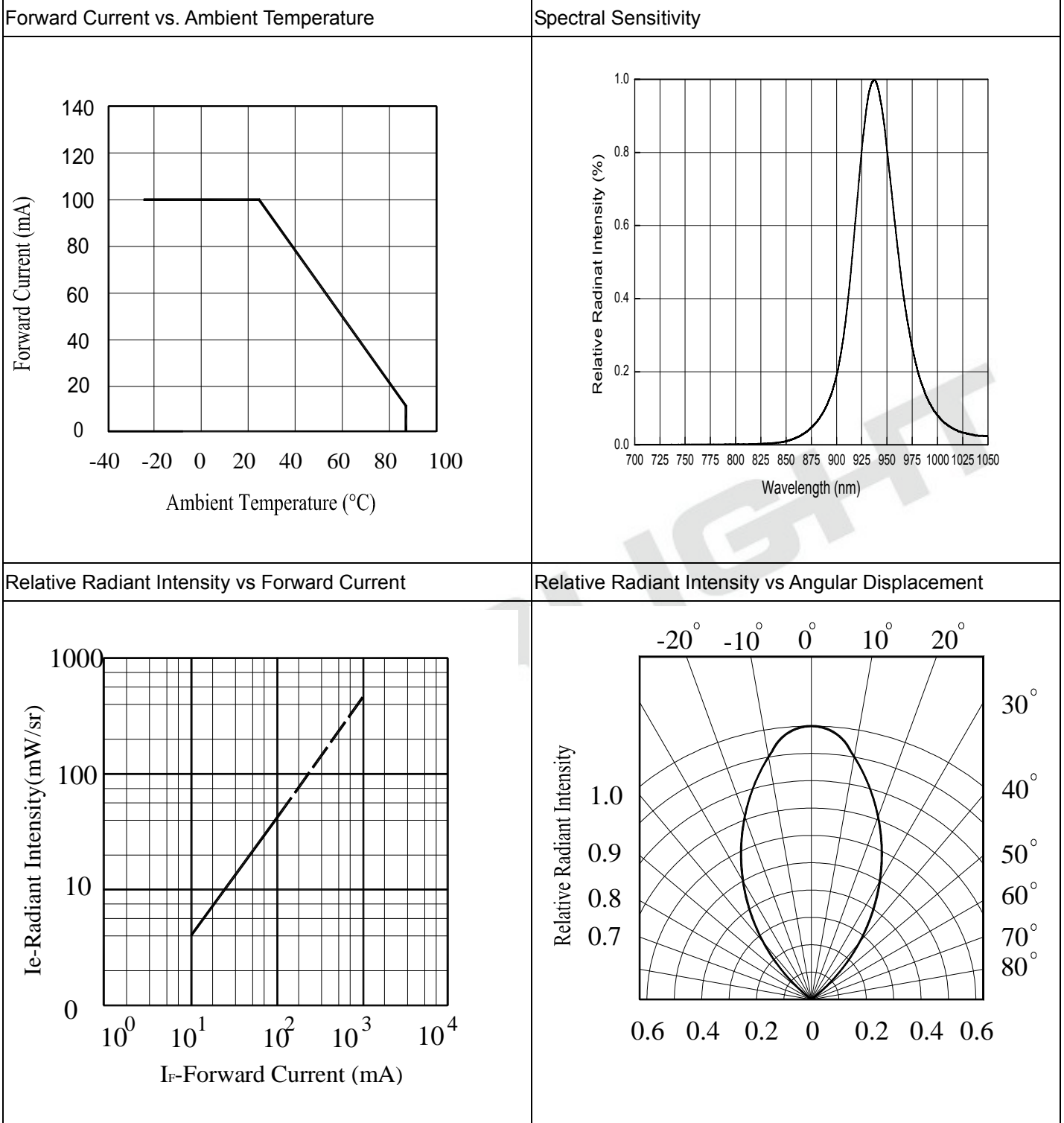

Typical Electrical/Optical/Characteristics Curves for PT

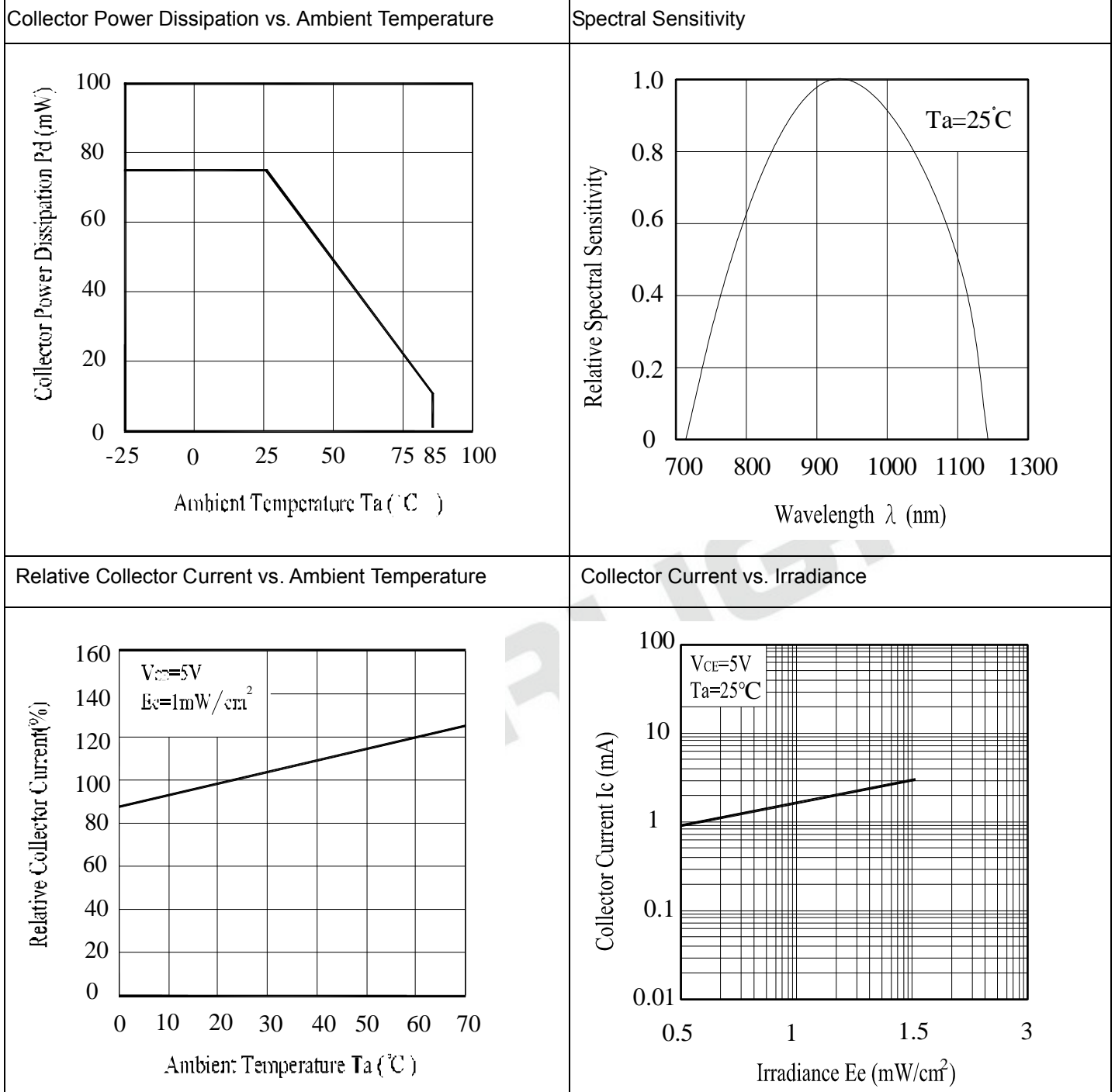

Collector Dark Current vs. Ambient Temperature

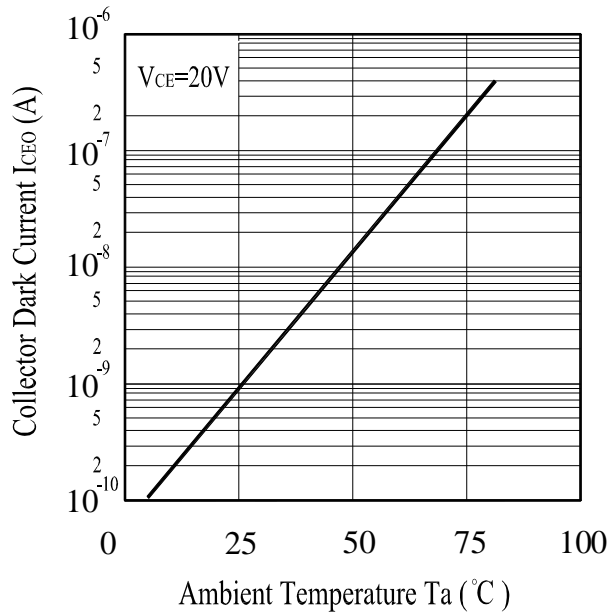

Collector Current vs. Collector-Emitter Voltage

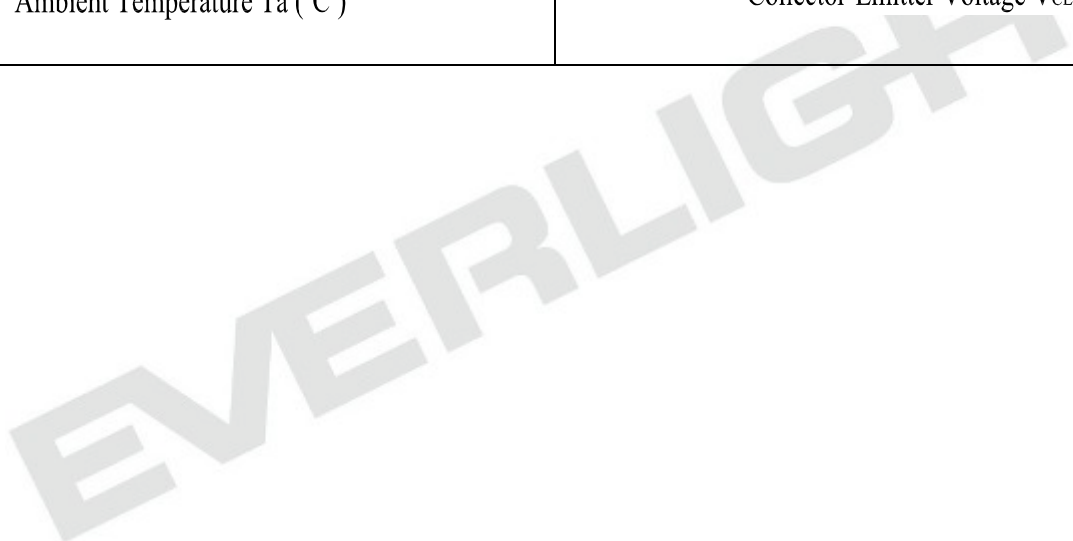
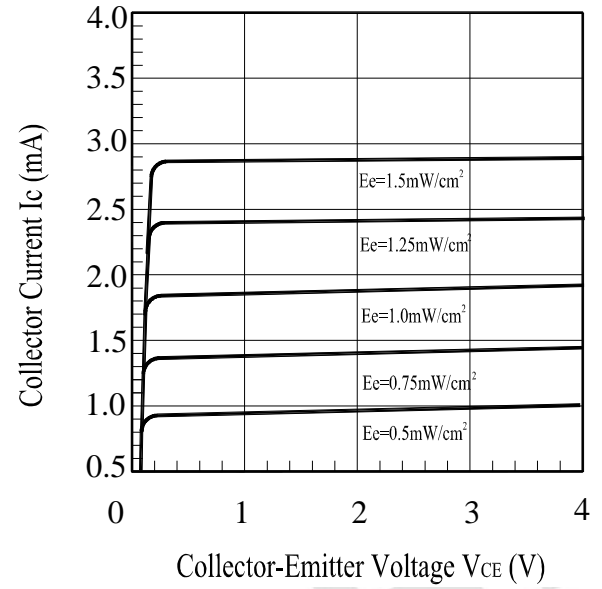

Typical Electrical/Optical/Characteristics Curves for ITR

Relative Collector Current vs Distance Between Sensor

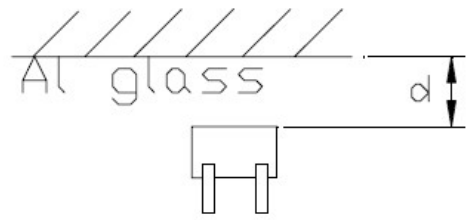
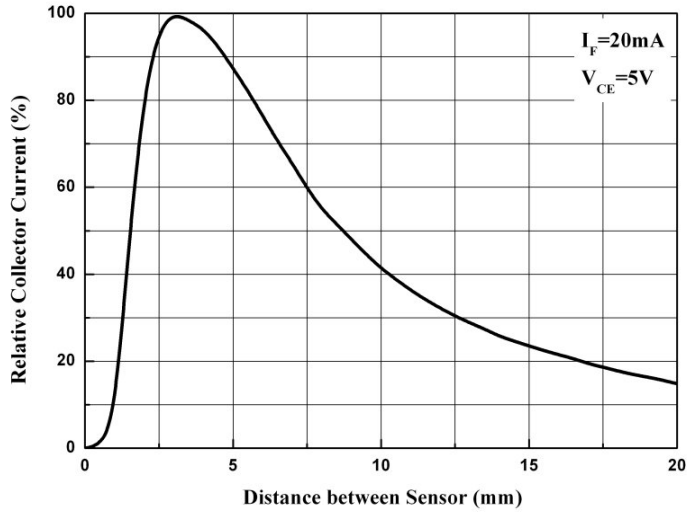

EVERLIGHT

Package Dimension

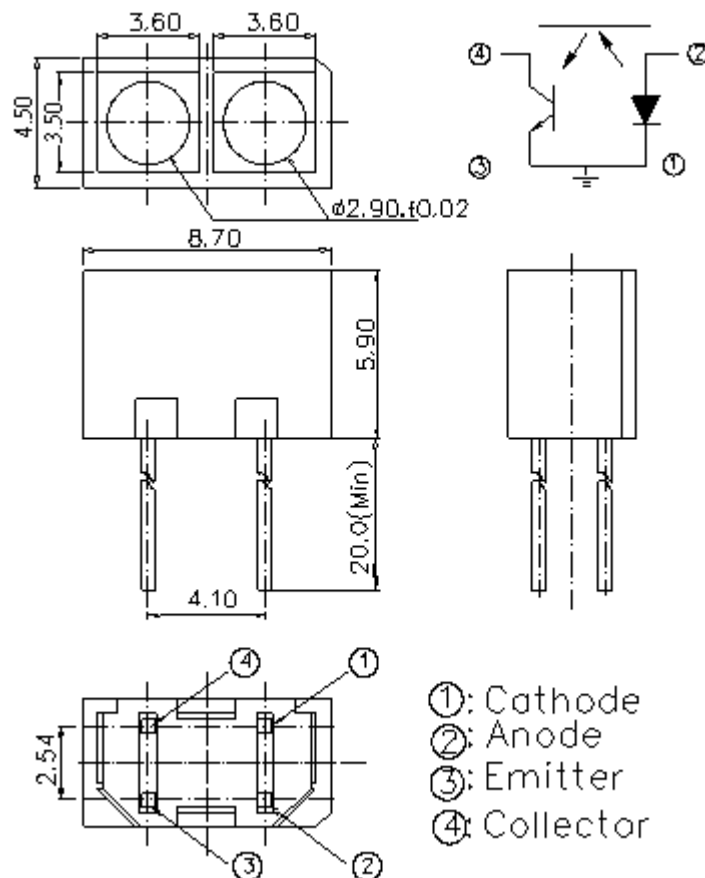

Note: Tolerances unless dimensions ± 0.25 mm

Packing Quantity Specification

- 1.150PCS/1 Bag, 5 Bags/1Box
2. 10Boxes/1Carton

Label Form Specification

(Pb)	EVERLIGHT	(X)
CPN: P/N:		RoHS
		
ITR9909		
QTY:	CAT:	
	HUE:	
LOT NO:	REF:	
		
Reference		
		

- CPN: Customer's Product Number
- P/N: Product Number
- QTY: Packing Quantity
- CAT: Luminous Intensity Rank
- HUE: Dom. Wavelength Rank
- REF: Forward Voltage Rank
- LOT No: Lot Number
- X: Month
- Reference: Identify Label Number

Notes

1. Above specification may be changed without notice. EVERLIGHT will reserve authority on material change for above specification.
2. When using this product, please observe the absolute maximum ratings and the instruction for using outlined in these specification sheets. EVERLIGHT assumes no responsibility for any damage resulting from use of the product which does not comply with the absolute maximum ratings and the instructions included in these specification sheets.
3. These specification sheets include materials protected under copyright of EVERLIGHT corporation. Please don't reproduce or cause anyone to reproduce them without EVERLIGHT's consent.

Данный компонент на территории Российской Федерации

Вы можете приобрести в компании MosChip.

Для оперативного оформления запроса Вам необходимо перейти по данной ссылке:

<http://moschip.ru/get-element>

Вы можете разместить у нас заказ для любого Вашего проекта, будь то серийное производство или разработка единичного прибора.

В нашем ассортименте представлены ведущие мировые производители активных и пассивных электронных компонентов.

Нашей специализацией является поставка электронной компонентной базы двойного назначения, продукции таких производителей как XILINX, Intel (ex.ALTERA), Vicor, Microchip, Texas Instruments, Analog Devices, Mini-Circuits, Amphenol, Glenair.

Сотрудничество с глобальными дистрибьюторами электронных компонентов, предоставляет возможность заказывать и получать с международных складов практически любой перечень компонентов в оптимальные для Вас сроки.

На всех этапах разработки и производства наши партнеры могут получить квалифицированную поддержку опытных инженеров.

Система менеджмента качества компании отвечает требованиям в соответствии с ГОСТ Р ИСО 9001, ГОСТ РВ 0015-002 и ЭС РД 009

Офис по работе с юридическими лицами:

105318, г.Москва, ул.Щербаковская д.3, офис 1107, 1118, ДЦ «Щербаковский»

Телефон: +7 495 668-12-70 (многоканальный)

Факс: +7 495 668-12-70 (доб.304)

E-mail: info@moschip.ru

Skype отдела продаж:

moschip.ru

moschip.ru_4

moschip.ru_6

moschip.ru_9