

GigaTLynx™ Non-isolated Power Modules: 4.5Vdc – 14Vdc input; 0.7Vdc to 2Vdc, 50A Output

TUNABLE™
LOOP
A LINEAGE POWER TRADEMARK

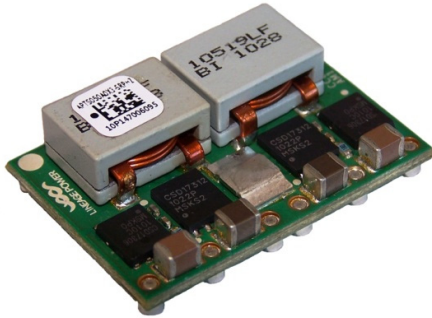

Applications

- Distributed power architectures
- Intermediate bus voltage applications
- Industrial applications
- Telecommunications equipment

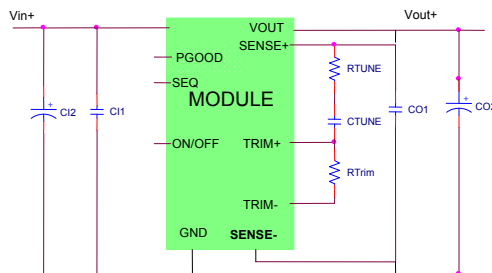

Description

The GigaTLynx™ series of power modules are non-isolated dc-dc converters that can deliver up to 50A of output current. These modules operate over a wide range of input voltage ($V_{IN} = 4.5\text{Vdc}-14\text{Vdc}$) and provide a precisely regulated output voltage from 0.7Vdc to 2.0Vdc, programmable via an external resistor. Features include remote On/Off, adjustable output voltage, over current and over temperature protection, output voltage sequencing and paralleling. The Ruggedized version (-D) is capable of operation up to 105°C and withstand high levels of shock and vibration. The Tunable Loop™ feature, allows the user to optimize the dynamic response of the converter to match the load with reduced amount of output capacitance leading to savings on cost and PWB area.

Features

- Compliant to RoHS EU Directive 2002/95/EC (-Z versions)
- Compliant to RoHS EU Directive 2002/95/EC with lead solder exemption (non-Z versions)
- Input voltage from 4.5Vdc to 14Vdc
- Output voltage programmable from 0.7 Vdc to 2.0Vdc via external resistor
- Output current up to 50A
- Tunable control loop for fast transient response
- True differential remote sense
- Negative remote On/Off logic
- Output voltage sequencing (EZ-SEQUENCE™)
- Output over current protection (non-latching)
- Over temperature protection
- Monotonic startup under pre-bias conditions
- Parallel operation with active current sharing
- Small size and low profile:
33 mm x 22.9 mm x 10 mm (max.)
(1.3 in x 0.9 in x 0.393 in (max.))
- Wide operating temperature range [-40°C to 105°C(Ruggedized: -D), 85°C(Regular)]
- UL* 60950-1, 2nd Ed. Recognized, CSA† C22.2 No. 60950-1-07 Certified, and VDE‡ (EN60950-1, 2nd Ed.) Licensed
- ISO** 9001 and ISO 14001 certified manufacturing facilities

* UL is a registered trademark of Underwriters Laboratories, Inc.
† CSA is a registered trademark of Canadian Standards Association.
‡ VDE is a trademark of Verband Deutscher Elektrotechniker e.V.
** ISO is a registered trademark of the International Organization of Standards

Absolute Maximum Ratings

Stresses in excess of the absolute maximum ratings can cause permanent damage to the device. These are absolute stress ratings only, functional operation of the device is not implied at these or any other conditions in excess of those given in the operations sections of the data sheet. Exposure to absolute maximum ratings for extended periods can adversely affect the device reliability.

Parameter	Device	Symbol	Min	Max	Unit
Input Voltage Continuous	All	V_{IN}	-0.3	14	Vdc
Sequencing pin voltage	All	V_{SEQ}	-0.3	4	Vdc
Operating Ambient Temperature (see Thermal Considerations section)	All -D version	T_A T_A	-40 -40	85 105	°C °C
Storage Temperature	All	T_{stg}	-55	125	°C

Electrical Specifications

Unless otherwise indicated, specifications apply over all operating input voltage, resistive load, and temperature conditions.

Parameter	Device	Symbol	Min	Typ	Max	Unit
Operating Input Voltage	$V_{O,set} \leq 2.0$	V_{IN}	4.5	—	14	Vdc
Maximum Input Current ($V_{IN} = V_{IN,min}$ to $V_{IN,max}$, $I_O = I_{O,max}$)	All	$I_{IN,max}$			26	Adc
Inrush Transient	All	$I^2 t$			1	$A^2 s$
Input No Load Current ($V_{IN} = V_{IN,nom}$, $I_O = 0$, module enabled)	$V_{O,set} = 0.7Vdc$ $V_{O,set} = 1.8Vdc$	$I_{IN,No load}$ $I_{IN,No load}$		73.4 136		mA mA
Input Stand-by Current ($V_{IN} = V_{IN,nom}$, module disabled)	All	$I_{IN,stand-by}$		1.3		mA
Input Reflected Ripple Current, peak-to-peak (5Hz to 20MHz, 1 μ H source impedance; $V_{IN,min}$ to $V_{IN,max}$, $I_O = I_{O,max}$; See Test configuration section)	All				73	mAp-p
Input Ripple Rejection (120Hz)	All			50		dB

CAUTION: This power module is not internally fused. An input line fuse must always be used.

This power module can be used in a wide variety of applications, ranging from simple standalone operation to an integrated part of sophisticated power architecture. To preserve maximum flexibility, internal fusing is not included; however, to achieve maximum safety and system protection, always use an input line fuse. The safety agencies require a surface mount, fast acting fuse (ie. Littelfuse 456030 series) with a maximum rating of 30 A (see Safety Considerations section). Based on the information provided in this data sheet on inrush energy and maximum dc input current, the same type of fuse with a lower rating can be used. Refer to the fuse manufacturer's data sheet for further information.

Electrical Specifications (continued)

Parameter	Device	Symbol	Min	Typ	Max	Unit
Output Voltage Set-point ($V_{IN}=V_{IN,nom}$, $I_O=I_{O,nom}$, $T_{ref}=25^{\circ}C$)	All	$V_{O,set}$	-1.0	—	+1.0	% $V_{O,set}$
Output Voltage (Over all operating input voltage, resistive load, and temperature conditions until end of life)	All	$V_{O,set}$	-2.0	—	+2.0	% $V_{O,set}$
Adjustment Range Selected by an external resistor	All	V_O	0.7		2.0	Vdc
Output Regulation						
Line ($V_{IN}=V_{IN,min}$ to $V_{IN,max}$)	All		—		5	mV
Load ($I_O=I_{O,min}$ to $I_{O,max}$)	All		—		8	mV
Temperature ($T_{ref}=T_{A,min}$ to $T_{A,max}$)	All		—		8	mV
Remote Sense Range	All				0.5	Vdc
Output Ripple and Noise on nominal output ($V_{IN}=V_{IN,nom}$ and $I_O=I_{O,min}$ to $I_{O,max}$ Cout = 1 μ F ceramic//2x10 μ F ceramic capacitors) Peak-to-Peak (5Hz to 20MHz bandwidth)	All		—		50	mV _{pk-pk}
External Capacitance ¹ Without the Tunable Loop™						
ESR \geq 1 m Ω	All	$C_{O,max}$	—	—	1200	μ F
ESR \geq 10 m Ω	All	$C_{O,max}$	—	—	10000	μ F
With the Tunable Loop						
ESR \geq 1 m Ω	All	$C_{O,max}$	—	—	20000	μ F
ESR \geq 10 m Ω	All	$C_{O,max}$	—	—	20000	μ F
Output Current	All	I_O	0		50A	Adc
Output Current Limit Inception (Hiccup Mode)	All	$I_{O,lim}$	—	180	—	% I_O
Output Short-Circuit Current ($V_O \leq 250mV$) (Hiccup Mode)	All	$I_{O,s/c}$	—	5.5	—	Adc
Efficiency	$V_{O,set} = 0.7Vdc$	η		81.1		%
$V_{IN} = 12V$, $T_A = 25^{\circ}C$	$V_{O,set} = 1.2Vdc$	η		87.0		%
$I_O = I_{O,max}$, $V_O = V_{O,set}$	$V_{O,set} = 1.8Vdc$	η		90.1		%
Switching Frequency	All	f_{sw}	—	260	—	kHz

General Specifications

Parameter	Min	Typ	Max	Unit
Telcordia Issue 2, Method I, Case 3, Calculated MTBF ($I_O=I_{O,max}$, $T_A=40^{\circ}C$)		4,755,661		Hours
Weight	—	14.22 (0.5)		g (oz.)

External capacitors may require using the new Tunable Loop™ feature to ensure that the module is stable as well as getting the best transient response. See the Tunable Loop™ section for details.

Feature Specifications

Unless otherwise indicated, specifications apply over all operating input voltage, resistive load, and temperature conditions. See Feature Descriptions for additional information.

Parameter	Device	Symbol	Min	Typ	Max	Unit
On/Off Signal Interface ($V_{IN}=V_{IN, min}$ to $V_{IN, max}$; open collector or equivalent, Signal referenced to GND) Logic High (On/Off pin open – Module OFF) Input High Current Input High Voltage Logic Low (Module ON) Input Low Current Input Low Voltage	All All All All	I _{IH} V _{IH} I _{IL} V _{IL}	0.5 3.0 — -0.3	— — — —	3.3 V _{IN, max} 200 0.6	mA V μA V
Turn-On Delay and Rise Times ($I_O=I_{O, max}$, $V_{IN} = V_{IN, nom}$, $T_A = 25^\circ C$,) Case 1: On/Off input is set to Logic Low (Module ON) and then input power is applied (delay from instant at which $V_{IN} = V_{IN, min}$ until $V_O=10\%$ of $V_{O, set}$) Case 2: Input power is applied for at least one second and then the On/Off input is set to logic Low (delay from instant at which $V_{on/off}=0.3V$ until $V_O=10\%$ of $V_{O, set}$) Output voltage Rise time (time for V_O to rise from 10% of $V_{O, set}$ to 90% of $V_{O, set}$)	All All All	T _{delay} T _{delay} Trise	— — —	4.8 4.8 3.6	— — —	msec msec msec
Output voltage overshoot – Startup $I_O= I_{O, max}$; $V_{IN} = 4.5$ to 14Vdc, $T_A = 25^\circ C$				—	3.0	% $V_{O, set}$
Over Temperature Protection (See Thermal Consideration section)	All	T _{ref}	—	125	—	°C
Sequencing Slew rate capability ($V_{IN, min}$ to $V_{IN, max}$; $I_{O, min}$ to $I_{O, max}$ $V_{SEQ} < V_O$)	All	dV _{SEQ} /dt		—	2	V/msec
Sequencing Delay time (Delay from $V_{IN, min}$ to application of voltage on SEQ pin)	All	T _{SEQ-delay}	10			msec
Tracking Accuracy Power-up (2V/ms) Power-down (1V/ms) ($V_{IN, min}$ to $V_{IN, max}$; $I_{O, min}$ - $I_{O, max}$ $V_{SEQ} < V_O$)	All	V _{SEQ} - V_O V _{SEQ} - V_O		100 200	200 400	mV mV
Input Undervoltage Lockout Turn-on Threshold Turn-off Threshold Hysteresis	All All All			4.26 4.04 0.22		V V Vdc
Forced Load Share Accuracy	All		—	10		% I_O
Number of units in Parallel	All				5	
PGOOD (Power Good) Internal pull-up, V _{PGOOD} Overvoltage threshold for PGOOD Undervoltage threshold for PGOOD	All All All			5 112.5 87.5		V % $V_{O, set}$ % $V_{O, set}$

Characteristic Curves

The following figures provide typical characteristics for the 12V Giga TLynx™ 50A at 0.7V_o and at 25°C.

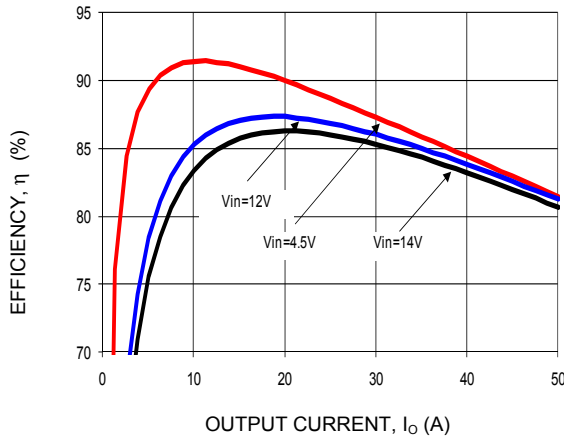

Figure 1. Converter Efficiency versus Output Current.

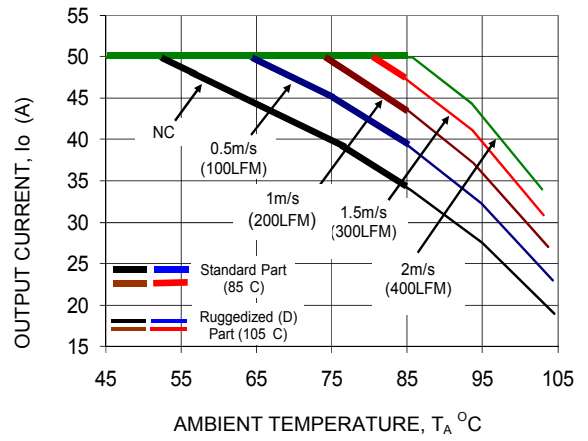

Figure 2. Derating Output Current versus Ambient Temperature and Airflow.

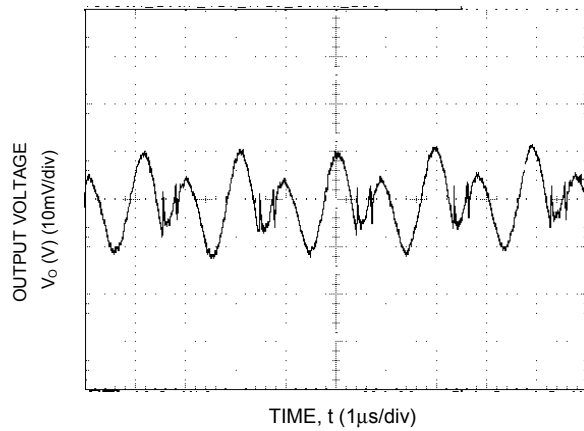

Figure 3. Typical output ripple and noise ($V_{IN} = 12V$, $I_o = I_{o,max}$).

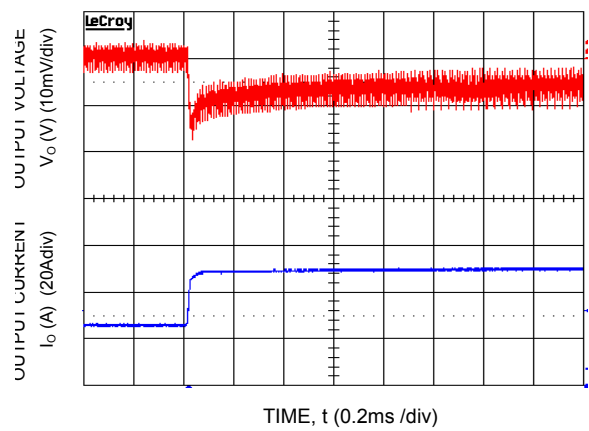

Figure 4. Transient Response to Dynamic Load Change from 50% to 100% at 12Vin, $C_{ext} = 5 \times 47 \mu F + 22 \times 330 \mu F$ polymer, $C_{Tune} = 330 nF$, $R_{Tune} = 100 \text{ ohms}$

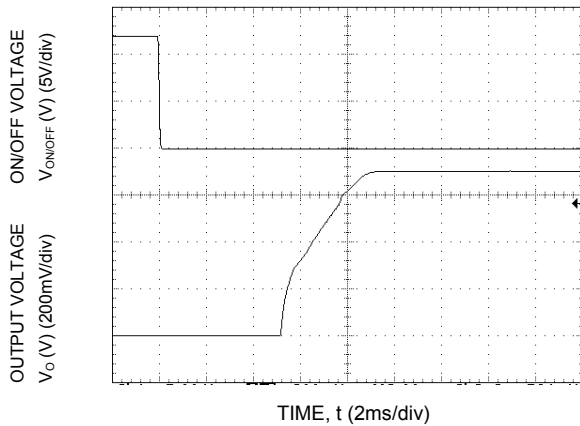

Figure 5. Typical Start-up Using On/Off Voltage ($I_o = I_{o,max}$).

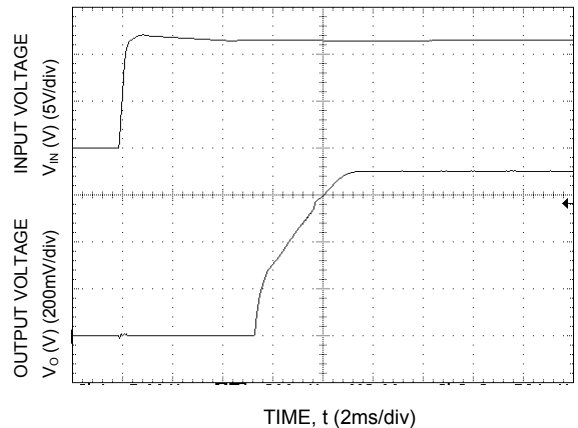

Figure 6. Typical Start-up Using Input Voltage ($V_{IN} = 12V$, $I_o = I_{o,max}$).

Characteristic Curves

The following figures provide typical characteristics for the 12V Giga TLynx™ 50A at 1.2 Vo and at 25°C.

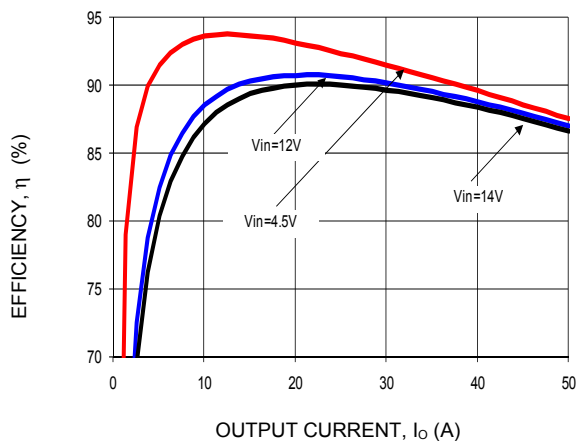

Figure 7. Converter Efficiency versus Output Current.

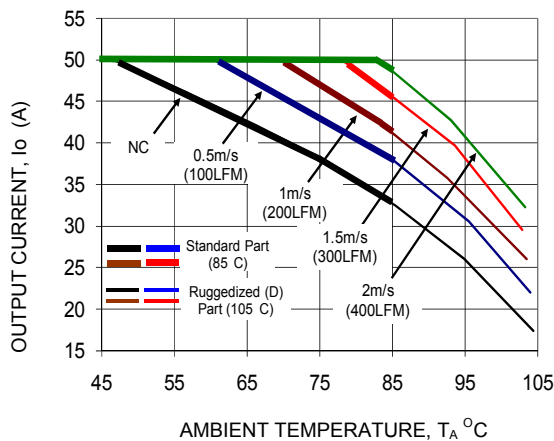

Figure 8. Derating Output Current versus Ambient Temperature and Airflow.

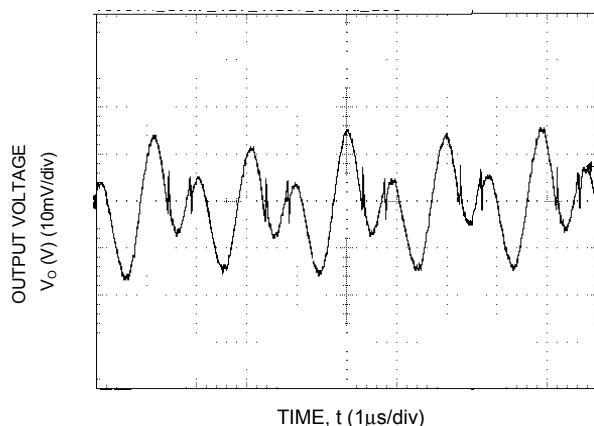

Figure 9. Typical output ripple and noise ($V_{IN} = 12V$, $I_o = I_{o,max}$).

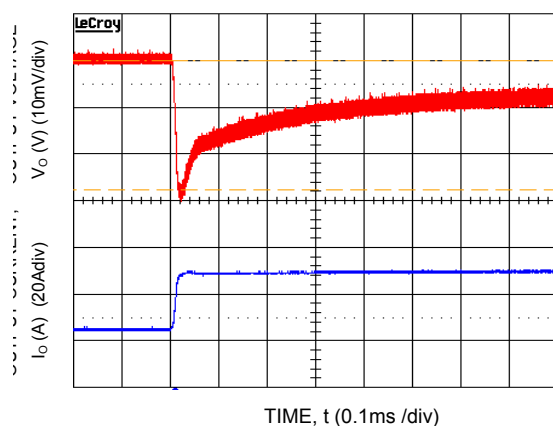

Figure 10. Transient Response to Dynamic Load Change from 50% to 100% at 12Vin, $C_{ext} = 5 \times 47\mu F + 13 \times 330\mu F$ polymer, $C_{Tune} = 120nF$, $R_{Tune} = 180\Omega$

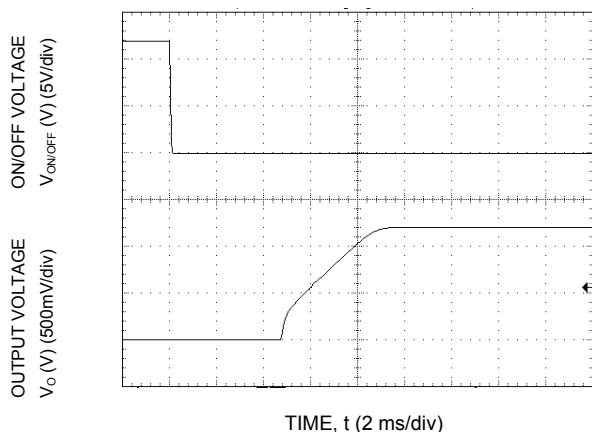

Figure 11. Typical Start-up Using On/Off Voltage ($I_o = I_{o,max}$).

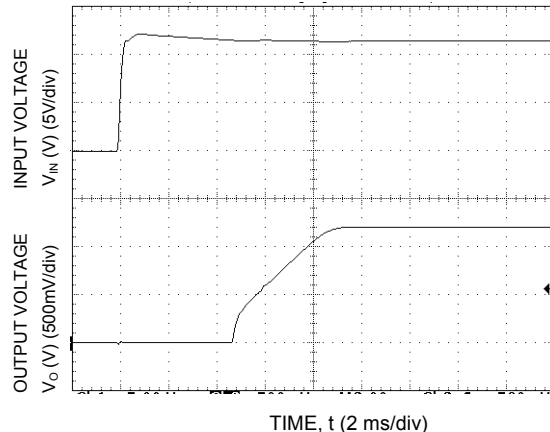

Figure 12. Typical Start-up Using Input Voltage ($V_{IN} = 12V$, $I_o = I_{o,max}$).

Characteristic Curves

The following figures provide typical characteristics for the 12V Giga TLynx™ 50A at 1.8V_o and at 25°C.

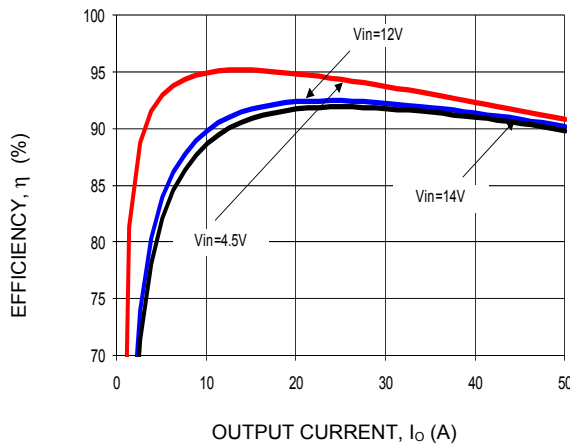

Figure 13. Converter Efficiency versus Output Current.

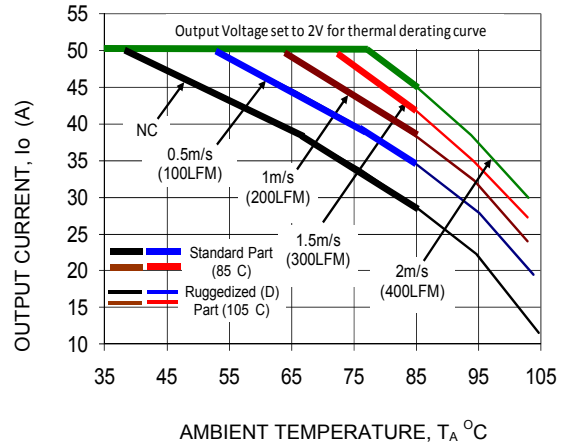

Figure 14. Derating Output Current versus Ambient Temperature and Airflow.

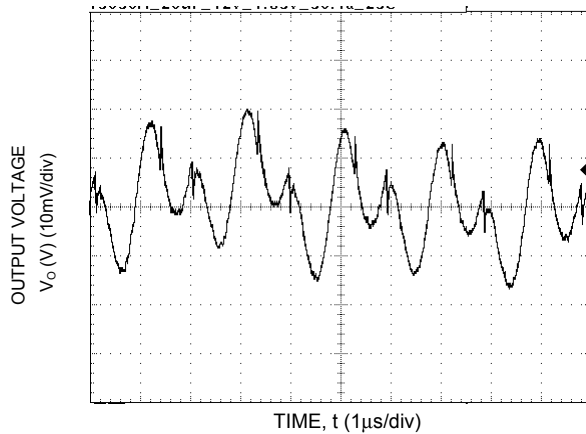

Figure 15. Typical output ripple and noise ($V_{IN} = 12V$, $I_o = I_{o,max}$).

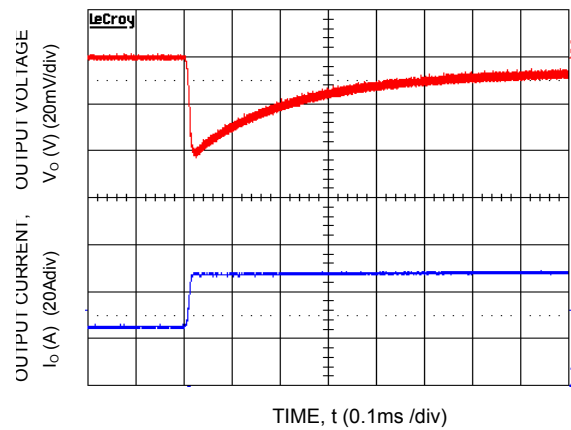

Figure 16. Transient Response to Dynamic Load Change from 50% to 100% at 12V_{in}, C_{ext} = 5x47µF+ 8x330µFpolymer, C_{Tune} = 47nF, R_{Tune} = 220ohms

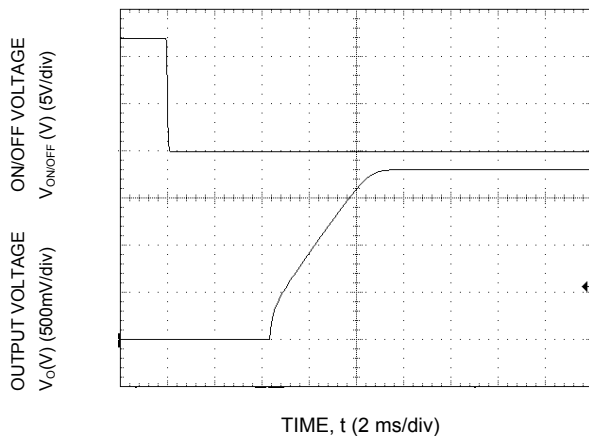

Figure 17. Typical Start-up Using On/Off Voltage ($I_o = I_{o,max}$).

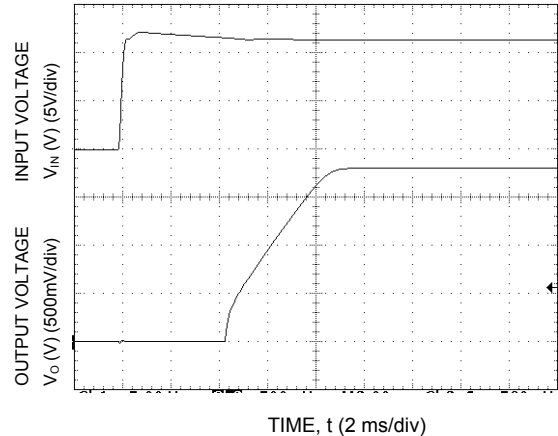
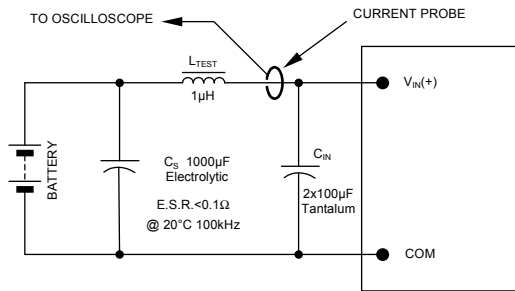

Figure 18. Typical Start-up Using Input Voltage ($V_{IN} = 12V$, $I_o = I_{o,max}$).

Test Configurations



NOTE: Measure input reflected ripple current with a simulated source inductance (L_{TEST}) of 1µH. Capacitor C_S offsets possible battery impedance. Measure current as shown above.

Figure 19. Input Reflected Ripple Current Test Setup.

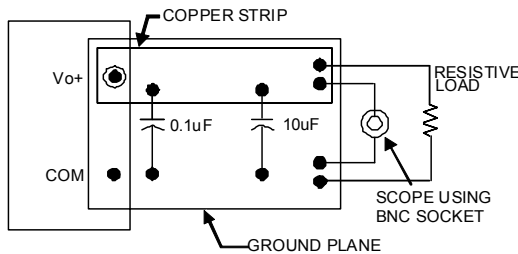

NOTE: All voltage measurements to be taken at the module terminals, as shown above. If sockets are used then Kelvin connections are required at the module terminals to avoid measurement errors due to socket contact resistance.

Figure 20. Output Ripple and Noise Test Setup.

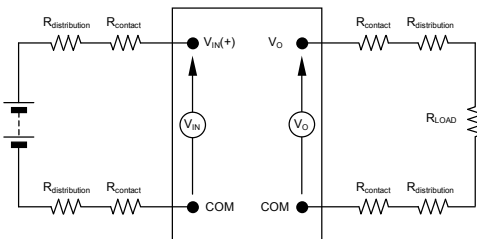

NOTE: All voltage measurements to be taken at the module terminals, as shown above. If sockets are used then Kelvin connections are required at the module terminals to avoid measurement errors due to socket contact resistance.

Figure 21. Output Voltage and Efficiency Test Setup.

$$\text{Efficiency } \eta = \frac{V_O \cdot I_O}{V_{IN} \cdot I_{IN}} \times 100 \%$$

Design Considerations

Input Filtering

The Giga TLynx™ module should be connected to a low ac-impedance source. A highly inductive source can affect the stability of the module. An input capacitance must be placed directly adjacent to the input pin of the module, to minimize input ripple voltage and ensure module stability.

To minimize input voltage ripple, ceramic capacitors are recommended at the input of the module. Figure 22 shows the input ripple voltage for various output voltages at maximum load current with 2x22 µF or 4x22 µF or 4x47 µF ceramic capacitors and an input of 12V.

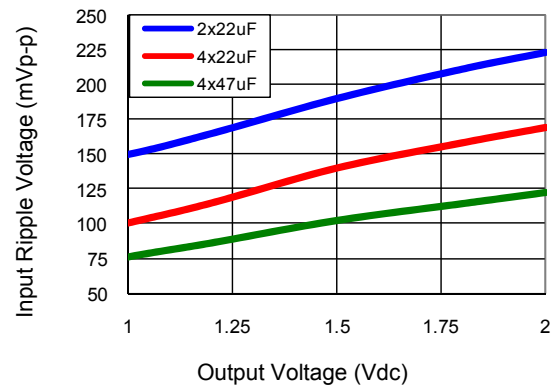

Figure 22. Input ripple voltage for various output voltages with 2x22 µF, 4x22 µF or 4x47 µF ceramic capacitors at the input (maximum load). Input voltage is 12V

Output Filtering

The Giga TLynx™ modules are designed for low output ripple voltage and will meet the maximum output ripple voltage specification with 0.1 µF ceramic and 10 µF ceramic capacitors at the output of the module. However, additional output filtering may be required by the system designer for a number of reasons. First, there may be a need to further reduce the output ripple and noise of the module. Second, the dynamic response characteristics may need to be customized to a particular load step change.

To reduce the output ripple and improve the dynamic response to a step load change, additional capacitance at the output can be used. Low ESR polymer and ceramic capacitors are recommended to improve the dynamic response of the module. Figure 23 provides output ripple information for different external capacitance values at various V_O and for full load currents. For stable operation of the module, limit the capacitance to less than the maximum output capacitance as specified in the electrical specification table. Optimal performance of the module can be achieved by using the Tunable Loop feature described later in this data sheet.

Feature Descriptions

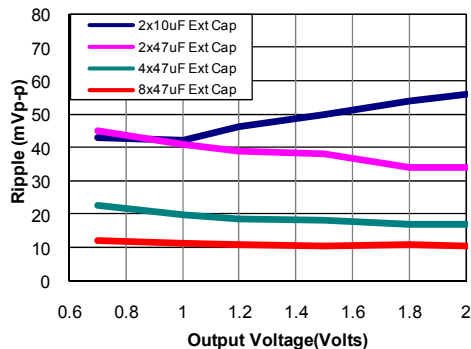

Figure 23. Output ripple voltage for various output voltages with external 2x10 µF, 2x47 µF, 4x47 µF or 8x47 µF ceramic capacitors at the output (50A load). Input voltage is 12V.

Safety Considerations

For safety agency approval the power module must be installed in compliance with the spacing and separation requirements of the end-use safety agency standards, i.e., UL 60950-1 2nd, CSA C22.2 No. 60950-1-07, DIN EN 60950-1:2006 + A11 (VDE0805 Teil 1 + A11):2009-11; EN 60950-1:2006 + A11:2009-03.

For the converter output to be considered meeting the requirements of safety extra-low voltage (SELV), the input must meet SELV requirements. The power module has extra-low voltage (ELV) outputs when all inputs are ELV. The input to these units is to be provided with a surface mount, fast acting fuse (ie. Littelfuse 456030 series) with a maximum rating of 30A in the positive input lead.

Remote On/Off

The GigaTLynx™ SMT power modules feature a On/Off pin for remote On/Off operation. If not using the On/Off pin, connect the pin to ground (the module will be ON). The On/Off signal ($V_{on/off}$) is referenced to ground. The circuit configuration for remote On/Off operation of the module using the On/Off pin is shown in Figure 24.

During a Logic High on the On/Off pin (transistor Q1 is OFF), the module remains OFF. The external resistor R1 should be chosen to maintain 3.0V minimum on the On/Off pin to ensure that the module is OFF when transistor Q1 is in the OFF state. Suitable values for R1 are 4.7K for input voltage of 12V and 3K for 5V_{in}. During Logic-Low when Q1 is turned ON, the module is turned ON.

The On/Off pin can also be used to synchronize the output voltage start-up and shutdown of multiple modules in parallel. By connecting On/Off pins of multiple modules, the output start-up can be synchronized (please refer to characterization curves).

Overcurrent Protection

To provide protection in a fault (output overload) condition, the unit should be equipped with internal current-limiting circuitry and can endure current limiting continuously. At the point of current-limit inception, the unit enters hiccup mode. The unit should operate normally once the output current is brought back into its specified range.

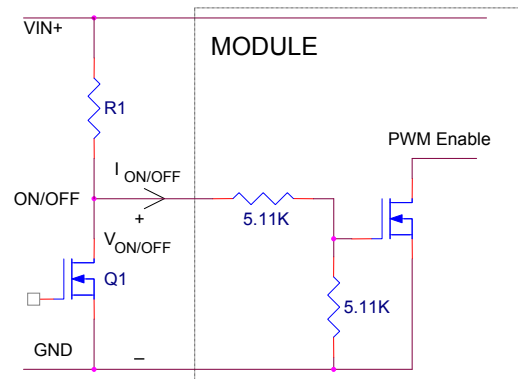

Figure 24. Remote On/Off Implementation using ON/OFF .

Overtemperature Protection

To provide protection in a fault condition, the unit is equipped with a thermal shutdown circuit. The unit will shutdown if the overtemperature threshold of 125°C is exceeded at the thermal reference point T_{ref} . The thermal shutdown is not intended as a guarantee that the unit will survive temperatures beyond its rating. Once the unit goes into thermal shutdown it will then wait to cool before attempting to restart.

Input Undervoltage Lockout

At input voltages below the input undervoltage lockout limit, module operation will be disabled. The module will begin to operate at an input voltage above the undervoltage lockout turn-on threshold.

Output Voltage Programming

The output voltage of the GigaTLynx™ can be programmable to any voltage from 0.7 Vdc to 2.0Vdc by connecting a single resistor (shown as R_{trim} in Figure 25) between the TRIM+ and TRIM pins of the module. The following equation will be used to set the output voltage of the module:

$$R_{trim} = \left[\frac{14000}{V_o - 0.7} \right] \Omega$$

By using a ±0.5% tolerance trim resistor with a TC of ±100ppm, a set point tolerance of ±1.5% can be achieved as specified in the electrical specification. Table 1 provides R_{trim} values required for some common output

voltages. The POL Programming Tool, available at www.lineagepower.com under the Design Tools section, helps determine the required external trim resistor needed for a specific output voltage.

Table 1

$V_{O, set}$ (V)	R_{trim} (K Ω)
0.7	Open
1.0	46.6
1.2	28
1.5	17.5
1.8	12.7

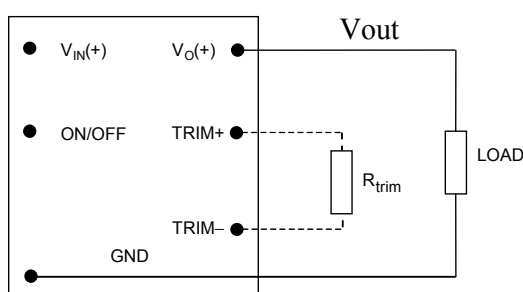

Figure 25. Circuit configuration to program output voltage using an external resistor.

Remote Sense

The GigaTLynx™ SMT power modules have differential Remote Sense to minimize the effects of distribution losses by regulating the voltage at the Remote Sense pin. The voltage between the SENSE pin and VOUT pin must not exceed 0.5V. Note that the output voltage of the module cannot exceed the specified maximum value. This includes the voltage drop between the SENSE and Vout pins. When the Remote Sense feature is not being used, connect the SENSE pin to the VOUT pin.

Voltage Margining

Output voltage margining can be implemented in the Giga TLynx™ modules by connecting a resistor, $R_{margin-up}$, from the Trim pin to the ground pin for margining-up the output voltage and by connecting a resistor, $R_{margin-down}$, from the Trim pin to output pin for margining-down. Figure 26 shows the circuit configuration for output voltage margining. The POL Programming Tool, available at www.lineagepower.com under the Design Tools section, also calculates the values of $R_{margin-up}$ and $R_{margin-down}$ for a specific output voltage and % margin. Please consult your local Lineage Power technical representative for additional details.

Monotonic Start-up and Shutdown

The Giga TLynx™ modules have monotonic start-up and shutdown behavior for any combination of rated input voltage, output current and operating temperature range.

Startup into Pre-biased Output

The Giga TLynx™ modules can start into a prebiased output as long as the prebias voltage is 0.5V less than the set output voltage. Note that prebias operation is not supported when output voltage sequencing is used.

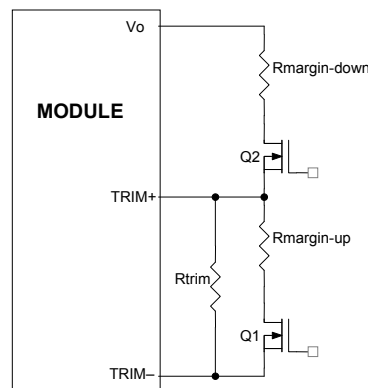

Figure 26. Circuit Configuration for margining Output voltage.

Output Voltage Sequencing

The Giga TLynx™ modules include a sequencing feature, EZ-SEQUENCE™ that enables users to implement various types of output voltage sequencing in their applications. This is accomplished via an additional sequencing pin. When not using the sequencing feature, leave it unconnected.

When an analog voltage is applied to the SEQ pin, the output voltage tracks this voltage until the output reaches the set-point voltage. The final value of the SEQ voltage must be set higher than the set-point voltage of the module. The output voltage follows the voltage on the SEQ pin on a one-to-one basis. By connecting multiple modules together, multiple modules can track their output voltages to the voltage applied on the SEQ pin.

For proper voltage sequencing, first, input voltage is applied to the module. The On/Off pin of the module is left unconnected or tied to GND so that the module is ON by default. After applying input voltage to the module, a minimum 10msec delay is required before applying voltage on the SEQ pin. Alternatively, input voltage can be applied while the unit is OFF and then the unit can be enabled. In this case the SEQ signal must be applied 10ms after the unit is enabled. This delay gives the module enough time to complete its internal power-up soft-start cycle. During the delay time, the SEQ pin may be held to ground.

After the 10msec delay, an analog voltage is applied to the SEQ pin and the output voltage of the module will track this voltage on a one-to-one volt bases until the

output reaches the set-point voltage. To initiate simultaneous shutdown of the modules, the SEQ pin voltage is lowered in a controlled manner. The output voltage of the modules tracks the voltages below their set-point voltages on a one-to-one basis. A valid input voltage must be maintained until the tracking and output voltages reach ground potential.

When using the EZ-SEQUENCE™ feature to control start-up of the module, pre-bias immunity during start-up is disabled. The pre-bias immunity feature of the module relies on the module being in the diode-mode during start-up. When using the EZ-SEQUENCE™ feature, modules goes through an internal set-up time of 10msec, and will be in synchronous rectification mode when the voltage at the SEQ pin is applied. This will result in the module sinking current if a pre-bias voltage is present at the output of the module. When pre-bias immunity during start-up is required, the EZ-SEQUENCE™ feature must be disabled. For additional guidelines on using the EZ-SEQUENCE™ feature please contact the Lineage Power technical representative for additional information.

Active Load Sharing (-P Option)

For additional power requirements, the Giga TLynx™ power module is also available with a parallel option. Up to five modules can be configured, in parallel, with active load sharing.

Good layout techniques should be observed when using multiple units in parallel. To implement forced load sharing, the following connections should be made:

- The share pins of all units in parallel must be connected together. The path of these connections should be as direct as possible.
- All remote-sense pins should be connected to the power bus at the same point, i.e., connect all the SENSE(+) pins to the (+) side of the bus. Close proximity and directness are necessary for good noise immunity

Some special considerations apply for design of converters in parallel operation:

- When sizing the number of modules required for parallel operation, take note of the fact that current sharing has some tolerance. In addition, under transient conditions such as a dynamic load change and during startup, all converter output currents will not be equal. To allow for such variation and avoid the likelihood of a converter shutting off due to a current overload, the total capacity of the paralleled system should be no more than 90% of the sum of the individual converters. As an example, for a system of four Giga TLynx™ converters in parallel, the total current drawn should be less than 90% of (4 x 50A) , i.e. less than 180A.
- All modules should be turned on and off together. This is so that all modules come up at the same time avoiding the problem of one converter sourcing current into the other leading to an overcurrent trip

condition. To ensure that all modules come up simultaneously, the on/off pins of all paralleled converters should be tied together and the converters enabled and disabled using the on/off pin.

- The share bus is not designed for redundant operation and the system will be non-functional upon failure of one of the unit when multiple units are in parallel. In particular, if one of the converters shuts down during operation, the other converters may also shut down due to their outputs hitting current limit. In such a situation, unless a coordinated restart is ensured, the system may never properly restart since different converters will try to restart at different times causing an overload condition and subsequent shutdown. This situation can be avoided by having an external output voltage monitor circuit that detects a shutdown condition and forces all converters to shut down and restart together.

When not using the active load share feature, share pins should be left unconnected.

Power Good

The Giga TLynx™ modules provide a Power Good (PGOOD) signal to indicate that the output voltage is within the regulation limits of the power module. The PGOOD signal will be de-asserted to a low state if any condition such as overtemperature, overcurrent or loss of regulation occurs that would result in the output voltage going $\pm 12.5\%$ outside the setpoint value. The PGOOD terminal is internally pulled-up and provides a voltage of $\sim 5V$, when asserted, thus eliminating the need for an external source and pull-up resistor. Additional external drive capability can be provided to the PGOOD terminal by using a source less than 5V and a suitable pull-up resistor to keep the overall external current below 4.5mA

Tunable Loop

The Giga TLynx™ modules have a new feature that optimizes transient response of the module called Tunable Loop™.

External capacitors are usually added to the output of the module for two reasons: to reduce output ripple and noise (see Fig. 23) and to reduce output voltage deviations from the steady-state value in the presence of dynamic load current changes. Adding external capacitance however affects the voltage control loop of the module, typically causing the loop to slow down with sluggish response. Larger values of external capacitance could also cause the module to become unstable.

The Tunable Loop™ allows the user to externally adjust the voltage control loop to match the filter network connected to the output of the module. The Tunable Loop™ is implemented by connecting a series R-C between the SENSE and TRIM+ pins of the module, as shown in Fig. 28. This R-C allows the user to externally

adjust the voltage loop feedback compensation of the module.

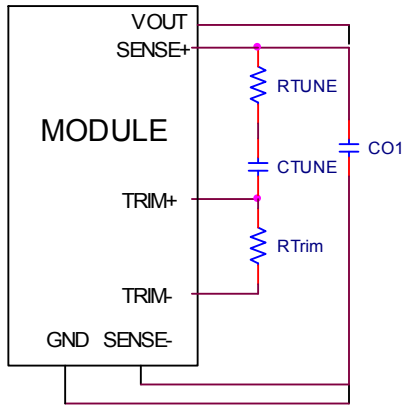

Figure 28. Circuit diagram showing connection of R_{TUNE} and C_{TUNE} to tune the control loop of the module.

Recommended values of R_{TUNE} and C_{TUNE} for different output capacitor combinations are given in Tables 2 and 3. Table 2 shows the recommended values of R_{TUNE} and C_{TUNE} for different values of ceramic output capacitors up to 2000uF that might be needed for an application to meet output ripple and noise requirements. Selecting R_{TUNE} and C_{TUNE} according to Table 2 will ensure stable operation of the module.

In applications with tight output voltage limits in the presence of dynamic current loading, additional output capacitance will be required. Table 3 lists recommended values of R_{TUNE} and C_{TUNE} in order to meet 2% output voltage deviation limits for some common output voltages in the presence of a 25A to 50A step change (50% of full load), with an input voltage of 12V.

Please contact your Lineage Power technical representative to obtain more details of this feature as well as for guidelines on how to select the right value of external R-C to tune the module for best transient performance and stable operation for other output capacitance values or input voltages other than 12V.

Table 2. General recommended values of R_{TUNE} and C_{TUNE} for $V_{in}=12V$ and various external ceramic capacitor combinations.

C_o	1 x 47uF	2x47uF	4x47uF	6x47uF	10 x 47uF	20 x 47uF
R_{TUNE}	330	330	330	330	270	270
C_{TUNE}	330pF	560pF	1200pF	1800pF	2200pF	5600pF

Table 3. Recommended values of R_{TUNE} and C_{TUNE} to obtain transient deviation of $\leq 2\%$ of V_{out} for a 25A step load with $V_{in}=12V$.

V_o	1.8V	1.2V	0.7V
C_o	5x47uF + 8x330uF polymer	5x47uF + 13x330uF polymer	5x47uF + 22x330uF polymer
R_{TUNE}	220	180	100
C_{TUNE}	47nF	120nF	330nF
ΔV	35mV	23mV	14mV

Thermal Considerations

Power modules operate in a variety of thermal environments; however, sufficient cooling should always be provided to help ensure reliable operation.

Considerations include ambient temperature, airflow, module power dissipation, and the need for increased reliability. A reduction in the operating temperature of the module will result in an increase in reliability. The thermal data presented here is based on physical measurements taken in a wind tunnel. The test set-up is shown in Figure 29. Note that the airflow is parallel to the short axis of the module as shown in Figure 30. The derating data applies to airflow in either direction of the module's short axis.

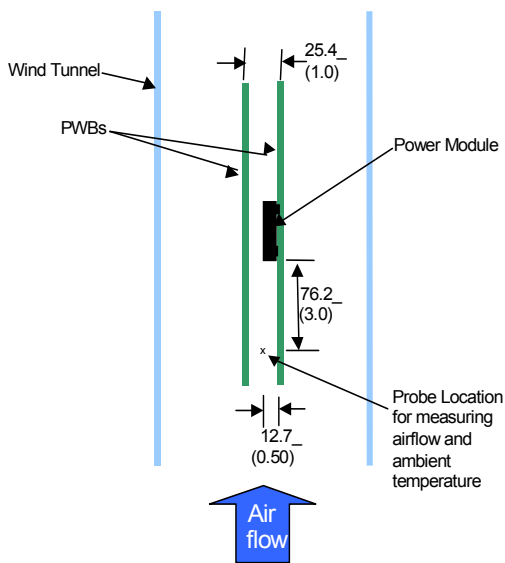

Figure 29. Thermal Test Setup.

The thermal reference points, T_{ref} used in the specifications is shown in Figure 30. For reliable operation the temperatures at this point should not exceed 125°C. The output power of the module should not exceed the rated power of the module ($V_{o,set} \times I_{o,max}$).

Please refer to the Application Note "Thermal Characterization Process For Open-Frame Board-Mounted Power Modules" for a detailed discussion of thermal aspects including maximum device temperatures.

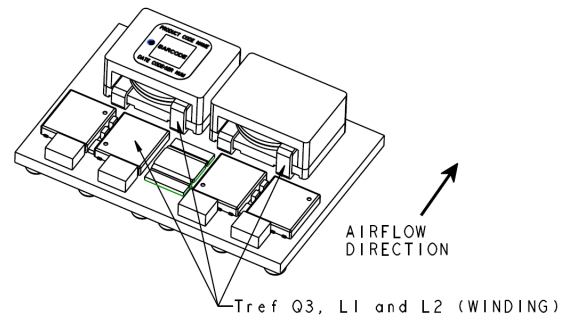

Figure 30. Preferred airflow direction and location of hot-spot of the module (T_{ref}).

Shock and Vibration

The ruggedized (-D version) of the modules are designed to withstand elevated levels of shock and vibration to be able to operate in harsh environments. The ruggedized modules have been successfully tested to the following conditions:

Non operating random vibration:

Random vibration tests conducted at 25C, 10 to 2000Hz, for 30 minutes each level, starting from 30Grms (Z axis) and up to 50Grms (Z axis). The units were then subjected to two more tests of 50Grms at 30 minutes each for a total of 90 minutes.

Operating shock to 40G per Mil Std. 810F, Method 516.4 Procedure I:

The modules were tested in opposing directions along each of three orthogonal axes, with waveform and amplitude of the shock impulse characteristics as follows:

All shocks were half sine pulses, 11 milliseconds (ms) in duration in all 3 axes.

Units were tested to the Functional Shock Test of MIL-STD-810, Method 516.4, Procedure I - Figure 516.4-4. A shock magnitude of 40G was utilized. The operational units were subjected to three shocks in each direction along three axes for a total of eighteen shocks.

Operating vibration per Mil Std 810F, Method 514.5 Procedure I:

The ruggedized (-D version) modules are designed and tested to vibration levels as outlined in MIL-STD-810F, Method 514.5, and Procedure 1, using the Power Spectral Density (PSD) profiles as shown in Table 4 and Table 5 for all axes. Full compliance with performance specifications was required during the performance test. No damage was allowed to the module and full compliance to performance specifications was required when the endurance environment was removed. The module was tested per MIL-STD-810, Method 514.5, Procedure I, for functional (performance) and endurance random vibration using the performance and endurance levels shown in Table 4 and Table 5 for all axes. The performance test has been split, with one half accomplished before the endurance test and one half after the endurance test (in each axis). The duration of the performance test was at least 16 minutes total per axis and at least 120 minutes total per axis for the endurance test. The endurance test period was 2 hours minimum per axis.

Table 4: Performance Vibration Qualification - All Axes

Frequency (Hz)	PSD Level (G ² /Hz)	Frequency (Hz)	PSD Level (G ² /Hz)	Frequency (Hz)	PSD Level (G ² /Hz)
10	1.14E-03	170	2.54E-03	690	1.03E-03
30	5.96E-03	230	3.70E-03	800	7.29E-03
40	9.53E-04	290	7.99E-04	890	1.00E-03
50	2.08E-03	340	1.12E-02	1070	2.67E-03
90	2.08E-03	370	1.12E-02	1240	1.08E-03
110	7.05E-04	430	8.84E-04	1550	2.54E-03
130	5.00E-03	490	1.54E-03	1780	2.88E-03
140	8.20E-04	560	5.62E-04	2000	5.62E-04

Table 5: Endurance Vibration Qualification - All Axes

Frequency (Hz)	PSD Level (G ² /Hz)	Frequency (Hz)	PSD Level (G ² /Hz)	Frequency (Hz)	PSD Level (G ² /Hz)
10	0.00803	170	0.01795	690	0.00727
30	0.04216	230	0.02616	800	0.05155
40	0.00674	290	0.00565	890	0.00709
50	0.01468	340	0.07901	1070	0.01887
90	0.01468	370	0.07901	1240	0.00764
110	0.00498	430	0.00625	1550	0.01795
130	0.03536	490	0.01086	1780	0.02035
140	0.0058	560	0.00398	2000	0.00398

Example Application Circuit

Requirements:

Vin: 12V
Vout: 1.8V
Iout: 37.5A max., worst case load transient is from 25A to 37.5A
ΔVout: 1.5% of Vout (27mV) for worst case load transient
Vin, ripple: 1.5% of Vin (180mV, p-p)

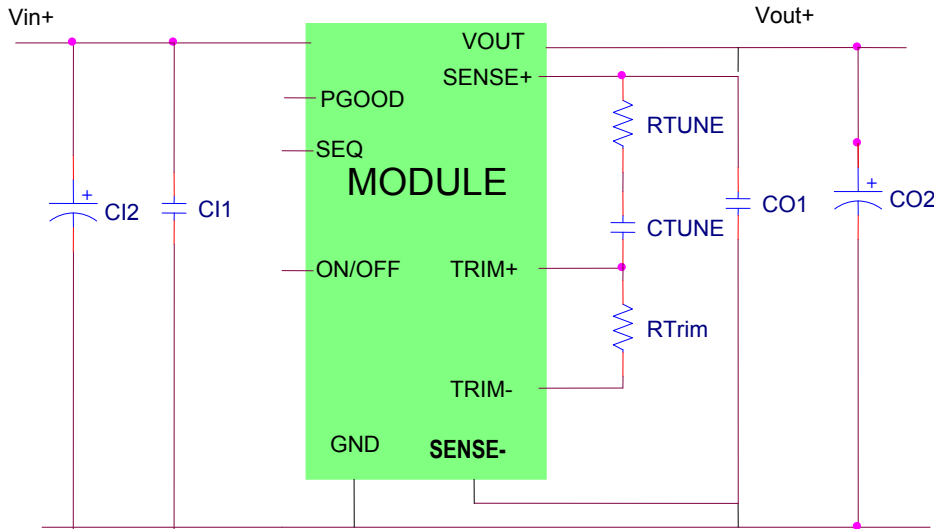

C11	4x22μF/16V ceramic capacitor (e.g. Murata GRM32ER61C226KE20)
C12	200μF/16V bulk electrolytic
CO1	5 x 47μF/6.3V ceramic capacitor (e.g. Murata GRM31CR60J476ME19)
CO2	8 x 330μF/6.3V Polymer (e.g. Sanyo Poscap)
CTune	47nF ceramic capacitor (can be 1206, 0805 or 0603 size)
RTune	220 ohms SMT resistor (can be 1206, 0805 or 0603 size)
RTrim	12.7kΩ SMT resistor (can be 1206, 0805 or 0603 size, recommended tolerance of 0.1%)

Mechanical Outline of Module

Dimensions are in millimeters and (inches).

Tolerances: x.x mm ± 0.5 mm (x.xx in. ± 0.02 in.) [unless otherwise indicated]

x.xx mm ± 0.25 mm (x.xxx in ± 0.010 in.)

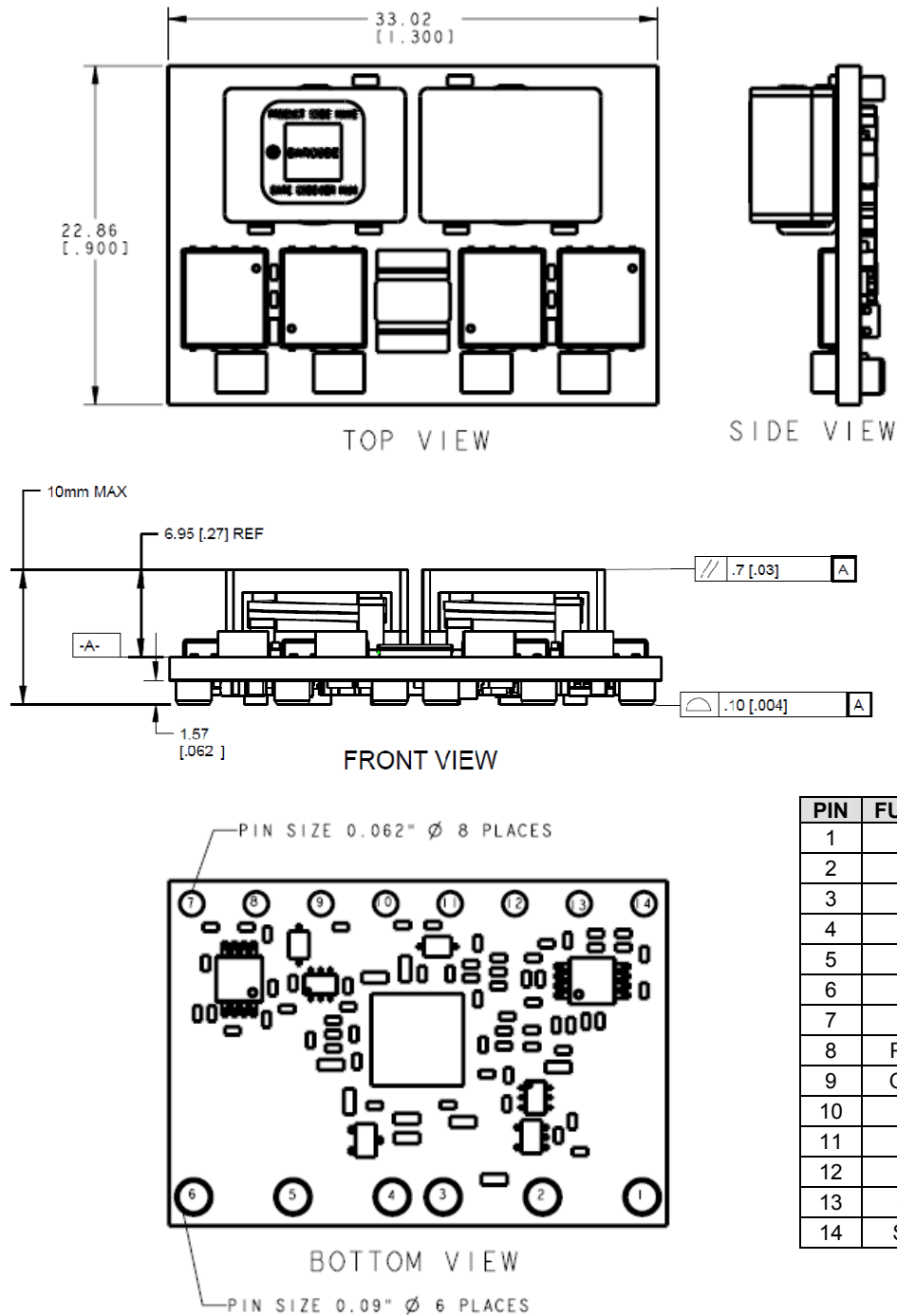

Mechanical Outline

Dimensions are in inches and (millimeters).

Tolerances: x.xx in. ± 0.02 in. (x.x mm ± 0.5 mm) [unless otherwise indicated]

x.xxx in ± 0.010 in. (x.xx mm ± 0.25 mm)

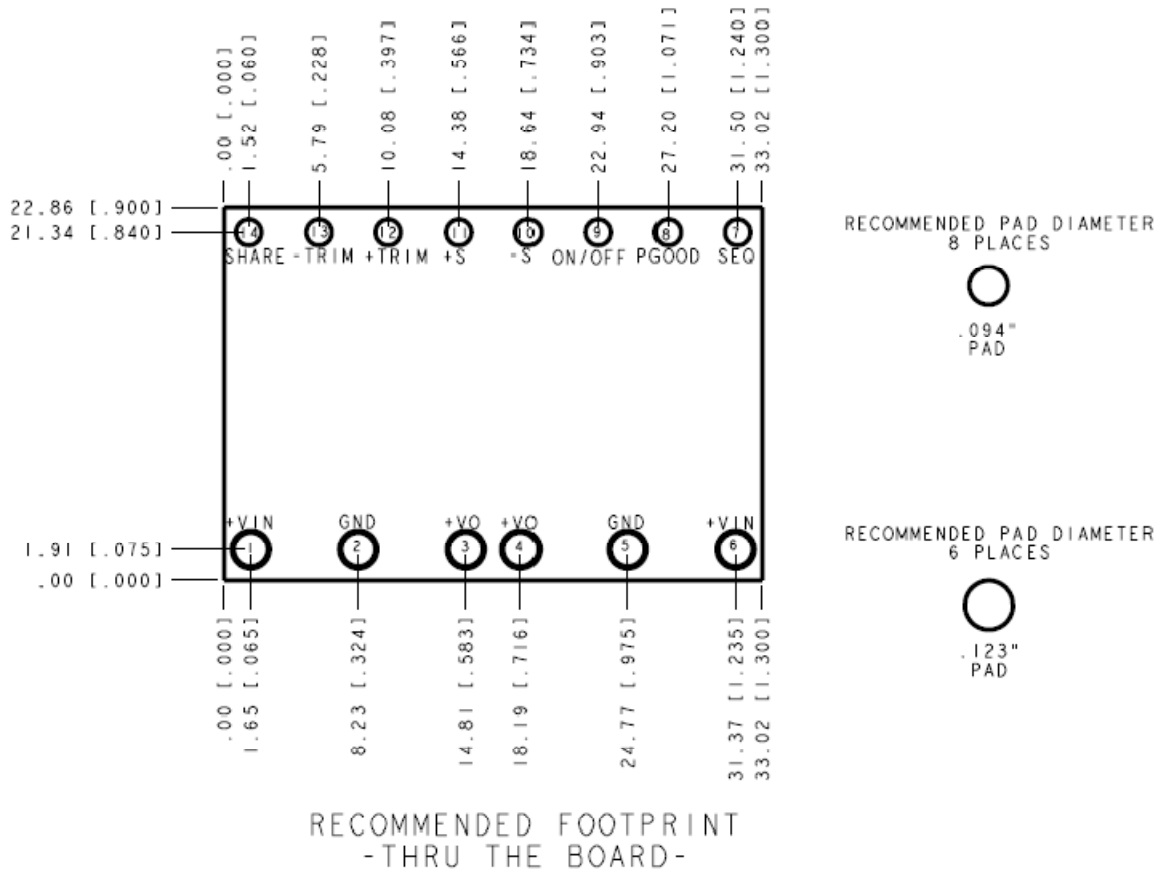

PIN	FUNCTION
1	VIN
2	GND
3	VOUT
4	VOUT
5	GND
6	VIN
7	SEQ
8	PGOOD
9	ON/OFF
10	VS-
11	VS+
12	+TRIM
13	-TRIM
14	SHARE

Packaging Details

The Giga TLynx™ SMT modules are supplied in tape & reel as standard. Modules are shipped in quantities of 140 modules per reel.

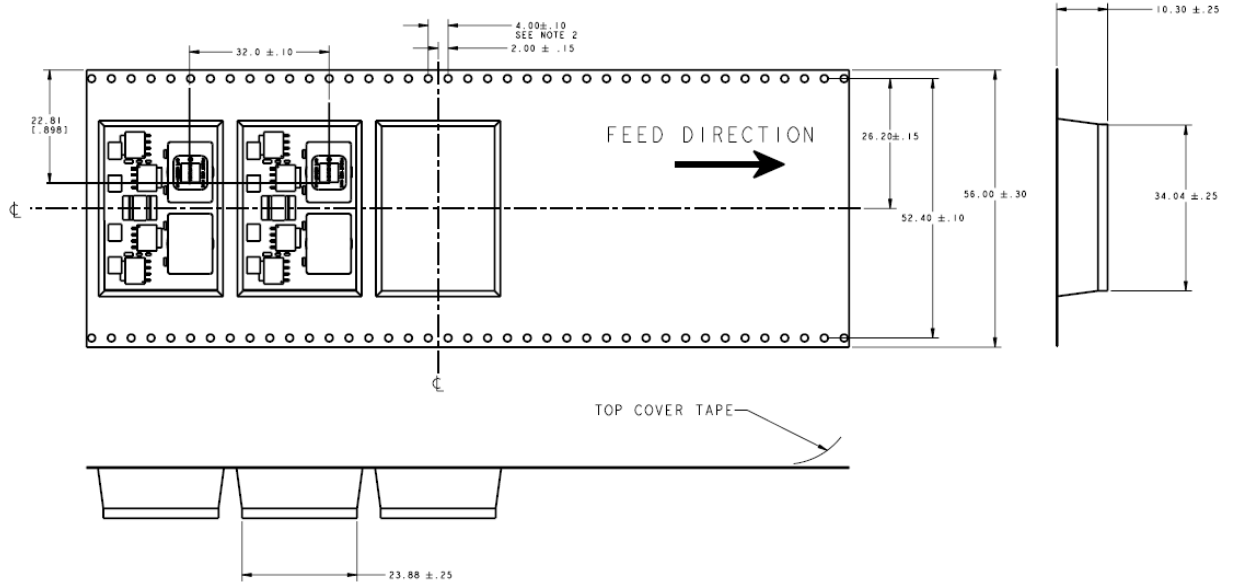

All Dimensions are in millimeters and (in inches).

Reel Dimensions

Outside diameter: 330.2 (13.0)
Inside diameter: 177.8 (7.0)
Tape Width: 56.0 (2.20)

Surface Mount Information

Pick and Place

The Giga TLynx™ SMT modules use an open frame construction and are designed for a fully automated assembly process. The modules are fitted with a label designed to provide a large surface area for pick and place operations. The label meets all the requirements for surface mount processing, as well as safety standards, and is able to withstand reflow temperatures of up to 300°C. The label also carries product information such as product code, serial number and location of manufacture.

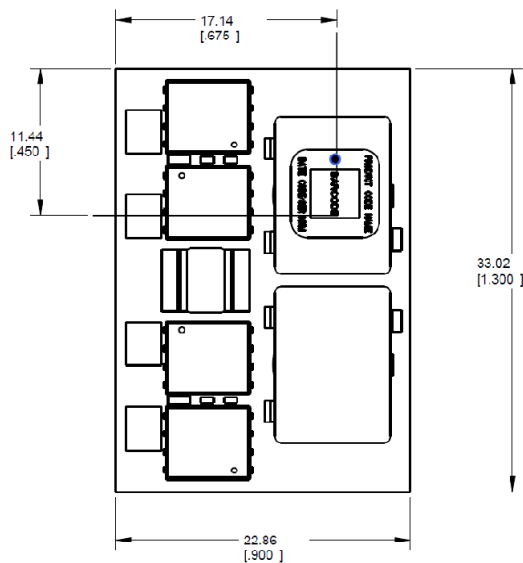

Figure 31. Pick and Place Location.

Nozzle Recommendations

The module weight has been kept to a minimum by using open frame construction. Even so, these modules have a relatively large mass when compared to conventional SMT components. Variables such as nozzle size, tip style, vacuum pressure and pick & placement speed should be considered to optimize this process. The minimum recommended inside nozzle diameter for reliable operation is 3mm. The maximum nozzle outer diameter, which will safely fit within the allowable component spacing, is 5 mm max.

Bottom Side Assembly

This module is not recommended for assembly on the bottom side of a customer board. If such an assembly is attempted, components may fall off the module during the second reflow process. If assembly on the bottom side is planned, please

contact Lineage Power for special manufacturing process instructions.

Lead-free (Pb-free) Soldering

The –Z version Giga TLynx modules are lead-free (Pb-free) and RoHS compliant and are both forward and backward compatible in a Pb-free and a SnPb soldering process. Failure to observe the instructions below may result in the failure of or cause damage to the modules and can adversely affect long-term reliability.

Pb-free Reflow Profile

Power Systems will comply with J-STD-020 Rev. C (Moisture/Reflow Sensitivity Classification for Nonhermetic Solid State Surface Mount Devices) for both Pb-free solder profiles and MSL classification procedures. This standard provides a recommended forced-air-convection reflow profile based on the volume and thickness of the package (table 5-2). The suggested Pb-free solder paste is Sn/Ag/Cu (SAC).

Recommended linear reflow profile using Sn/Ag/Cu solder:

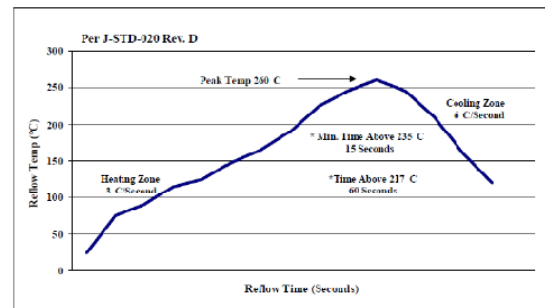

NOTE: Soldering outside of the recommended profile requires testing to verify results and performance.

Tin Lead Soldering

The Giga TLynx™ SMT power modules are lead free modules and can be soldered either in a lead-free solder process or in a conventional Tin/Lead (Sn/Pb) process. It is recommended that the customer review data sheets in order to customize the solder reflow profile for each application board assembly. The following instructions must be observed when soldering these units. Failure to observe these instructions may result in the failure of or cause damage to the modules, and can adversely affect long-term reliability.

In a conventional Tin/Lead (Sn/Pb) solder process peak reflow temperatures are limited to less than 235°C. Typically, the eutectic solder melts at 183°C, wets the land, and subsequently wicks the device connection. Sufficient time must be allowed to fuse the plating on the connection to ensure a reliable solder joint. There are several types of SMT reflow technologies currently used in the industry. These surface mount power modules can be reliably soldered using natural forced convection, IR (radiant infrared), or a combination of convection/IR. For reliable soldering the solder reflow profile should be established by accurately measuring the modules CP connector temperatures.

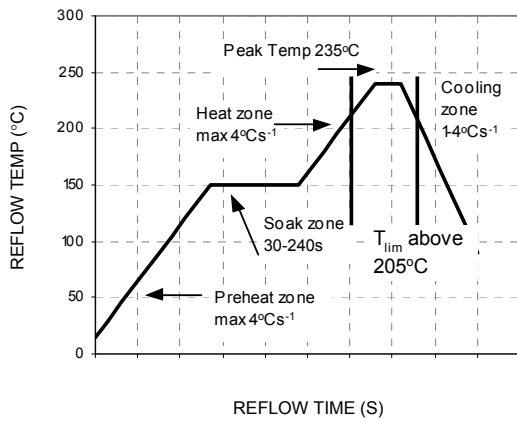

Figure 32. Reflow Profile for Tin/Lead (Sn/Pb) process.

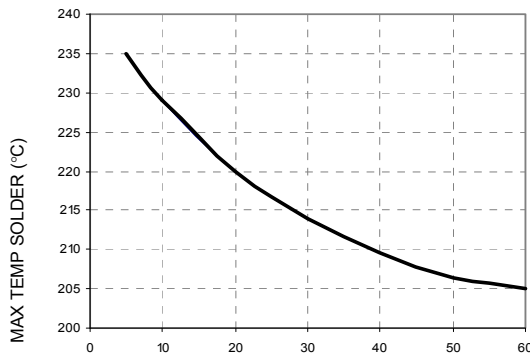

Figure 33. Time Limit Curve Above 205°C Reflow for Tin Lead (Sn/Pb) process.

MSL Rating

The Giga TLynx™ SMT modules have a MSL rating of 2.

Storage and Handling

The recommended storage environment and handling procedures for moisture-sensitive surface mount packages is detailed in J-STD-033 Rev. B (Handling, Packing, Shipping and Use of Moisture/Reflow Sensitive Surface Mount Devices). Moisture barrier bags (MBB) with desiccant are required for MSL ratings of 2 or greater. These sealed packages should not be broken until time of use. Once the original package is broken, the floor life of the product at conditions of ≤ 30°C and 60% relative humidity varies according to the MSL rating (see J-STD-033A). The shelf life for dry packed SMT packages will be a minimum of 12 months from the bag seal date, when stored at the following conditions: < 40°C, < 90% relative humidity.

Post Solder Cleaning and Drying Considerations

Post solder cleaning is usually the final circuit-board assembly process prior to electrical board testing. The result of inadequate cleaning and drying can affect both the reliability of a power module and the testability of the finished circuit-board assembly. For guidance on appropriate soldering, cleaning and drying procedures, refer to *Board Mounted Power Modules: Soldering and Cleaning* Application Note (AN04-001).

Ordering Information

Please contact your Lineage Power Sales Representative for pricing, availability and optional features.

Table 6. Device Codes

Device Code	Input Voltage Range	Output Voltage	Output Current	On/Off Logic	Sequencing	Comcodes
APTS050A0X3-SRPHZ	4.5 – 14Vdc	0.7 – 2.0Vdc	50A	Negative	Yes	CC109155314
APTS050A0X3-SRPHDZ	4.5 – 14Vdc	0.7 – 2.0Vdc	50A	Negative	Yes	CC109170585

Table 7. Coding Scheme

TLynx family	Sequencing feature.	Input voltage range	Output current	Output voltage	On/Off logic	Remote Sense	Options	ROHS Compliance
AP	T	S	050A0	X		3	-SRPHD	Z
	T = with Seq.	S = 4.5 - 14V	50A	X = programmable output	No entry = negative 4 = positive	3 = Remote Sense	S = Surface Mount R = Tape&Reel P = Paralleling H=2 ground pins D = 105°C operating ambient, 40G operating shock as per MIL Std 810F	Z = ROHS6



LINEAGE POWER®

World Wide Headquarters
Lineage Power Corporation
601 Shiloh Road, Plano, TX 75074, USA
+1-888-LINEAGE(546-3243)
(Outside U.S.A.: **+1-972-244-WATT(9288)**)
www.lineagepower.com
e-mail: techsupport1@lineagepower.com

Asia-Pacific Headquarters
Tel: +86.021.54279977*808

Europe, Middle-East and Africa Headquarters
Tel: +49.89.878067-280

India Headquarters
Tel: +91.80.28411633

Lineage Power reserves the right to make changes to the product(s) or information contained herein without notice. No liability is assumed as a result of their use or application. No rights under any patent accompany the sale of any such product(s) or information.

Lineage Power DC-DC products are protected under various patents. Information on these patents is available at www.lineagepower.com/patents.

© 2011 Lineage Power Corporation, (Plano, Texas) All International Rights Reserved.

Данный компонент на территории Российской Федерации

Вы можете приобрести в компании MosChip.

Для оперативного оформления запроса Вам необходимо перейти по данной ссылке:

<http://moschip.ru/get-element>

Вы можете разместить у нас заказ для любого Вашего проекта, будь то серийное производство или разработка единичного прибора.

В нашем ассортименте представлены ведущие мировые производители активных и пассивных электронных компонентов.

Нашей специализацией является поставка электронной компонентной базы двойного назначения, продукции таких производителей как XILINX, Intel (ex.ALTERA), Vicor, Microchip, Texas Instruments, Analog Devices, Mini-Circuits, Amphenol, Glenair.

Сотрудничество с глобальными дистрибьюторами электронных компонентов, предоставляет возможность заказывать и получать с международных складов практически любой перечень компонентов в оптимальные для Вас сроки.

На всех этапах разработки и производства наши партнеры могут получить квалифицированную поддержку опытных инженеров.

Система менеджмента качества компании отвечает требованиям в соответствии с ГОСТ Р ИСО 9001, ГОСТ РВ 0015-002 и ЭС РД 009

Офис по работе с юридическими лицами:

105318, г.Москва, ул.Щербаковская д.3, офис 1107, 1118, ДЦ «Щербаковский»

Телефон: +7 495 668-12-70 (многоканальный)

Факс: +7 495 668-12-70 (доб.304)

E-mail: info@moschip.ru

Skype отдела продаж:

moschip.ru

moschip.ru_4

moschip.ru_6

moschip.ru_9