

MAX9939

SPI Programmable-Gain Amplifier with Input VOS Trim and Output Op Amp

General Description

The MAX9939 is a general-purpose, differential-input programmable-gain amplifier (PGA) that is ideal for conditioning a variety of wide dynamic range signals such as those found in motor current-sense, medical instrumentation, and sonar data acquisition applications. It features programmable differential gains from 0.2V/V to 157V/V, input offset-voltage compensation, and an output amplifier that can be configured either as a high-order active filter or to provide a differential output.

The PGA is optimized for high-signal bandwidth and its gain can be programmed to be 0.2V/V, 1V/V, 10V/V, 20V/V, 30V/V, 40V/V, 60V/V, 80V/V, 119V/V, and 157V/V. Precision resistor matching provides extremely low gain tempco and high CMRR. Although the MAX9939 operates from a single supply V_{CC} between 2.9V to 5.5V, it can process signals both above and below ground due to the use of an input level-shifting amplifier stage. Furthermore, its inputs are protected to $\pm 16V$, allowing it to withstand fault conditions and signal overranges.

The output amplifier is designed for high bandwidth and low-bias currents, making it ideal for use in multiple-feedback active filter topologies that offer much higher Qs and stopband attenuation than Sallen-Key architectures.

The MAX9939 draws 3.4mA of quiescent supply current at 5V, and includes a software-programmable shutdown mode that reduces its supply current to only 13 μ A. The MAX9939 is available in a 10-pin μ MAX[®] package and operates over the -40°C to +125°C automotive temperature range.

Applications

- Sensorless Motor Control
- Medical Signal Conditioning
- Sonar and General Purpose Data Acquisition
- Differential to Single-Ended Conversion
- Differential-Input, Differential-Output Signal Amplification
- Sensor Interface and Signal Processing

μ MAX is a registered trademark of Maxim Integrated Products, Inc.

Functional Diagram appears at end of data sheet.

Features

- SPI-Programmable Gains: 0.2V/V to 157V/V
- Extremely Low Gain Tempco
- Integrated Amplifier for R/C Programmable Active Filter
- Input Offset-Voltage Compensation
- Input Protection to $\pm 16V$
- 13 μ A Software Shutdown Mode
- -40°C to +125°C Operating Temperature Range
- 10-Pin μ MAX Package

Ordering Information

| PART | TEMP RANGE | PIN-PACKAGE |
|----------------|-----------------|--------------|
| MAX9939AUB+ | -40°C to +125°C | 10 μ MAX |
| MAX9939AUB/V+T | -40°C to +125°C | 10 μ MAX |

/V denotes an automotive-qualified part.

+Denotes a lead(Pb)-free/RoHS-compliant package.

Pin Configuration

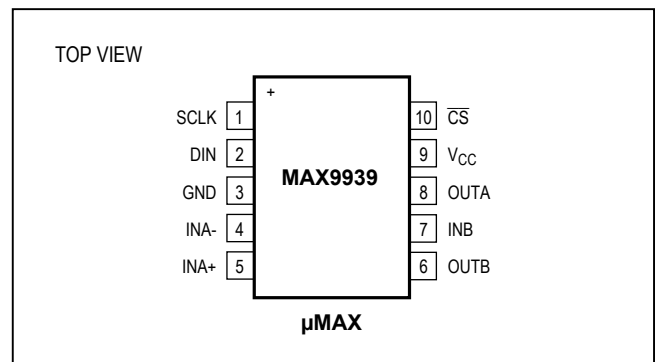

Absolute Maximum Ratings

| | | | |
|---|-----------------------------------|---|-----------------|
| V _{CC} to GND | -0.3V to +6V | Operating Temperature Range | -40°C to +125°C |
| INB, OUTA, OUTB, SCLK, DIN, CS | -0.3V to (V _{CC} + 0.3V) | Junction Temperature | +150°C |
| INA+, INA- to GND | -16V to +16V | Storage Temperature Range | -65°C to +150°C |
| Output Short-Circuit Current Duration | Continuous | Lead Temperature (soldering, 10s) | +300°C |
| Continuous Input Current into Any Terminal | ±20mA | Soldering Temperature (reflow) | +260°C |
| Continuous Power Dissipation (T _A = +70°C) | | | |
| 10-Pin μMAX (derate 5.6mW/°C above +70°C) | 707mW | | |

Stresses beyond those listed under "Absolute Maximum Ratings" may cause permanent damage to the device. These are stress ratings only, and functional operation of the device at these or any other conditions beyond those indicated in the operational sections of the specifications is not implied. Exposure to absolute maximum rating conditions for extended periods may affect device reliability.

Electrical Characteristics

(V_{CC} = 5V, V_{GND} = 0V, V_{INA+} = V_{INA-}, Gain = 10V/V, R_{OUTA} = R_{OUTB} = 1kΩ to V_{CC}/2, T_A = T_{MIN} to T_{MAX}, unless otherwise noted. Typical values are at T_A = +25°C.) (Note 1)

| PARAMETER | SYMBOL | CONDITIONS | MIN | TYP | MAX | UNITS |
|---|-----------------------------------|--|---------------------|------|-----------------------|--------|
| PGA CHARACTERISTICS | | | | | | |
| Gain Error | GE | T _A = +25°C, 0.2V ≤ V _{OUTA} ≤ V _{CC} - 0.2V | | 0.05 | 0.38 | % |
| Gain Temperature-Coefficient | T _c -GE | | | 2.2 | 17 | ppm/°C |
| Input Offset Voltage (Note 2) | V _{OS-A} | With no V _{OS} trim, T _A = +25°C | | 1.5 | 9 | mV |
| | | With no V _{OS} trim, T _A = T _{MIN} to T _{MAX} | | | 15 | |
| Input Offset-Voltage Drift | | | | 10 | | μV/C |
| Input Offset-Voltage Trim Range | | | | ±17 | | mV |
| Input Common-Mode Range | V _{CM} | Guaranteed by CMRR test (Note 3) | -V _{CC} /2 | | V _{CC} - 2.2 | V |
| Common-Mode Rejection Ratio | CMRR | -1V ≤ V _{CM} ≤ V _{CC} - 2.2V | 50 | 60 | | dB |
| | | -V _{CC} /2 ≤ V _{CM} ≤ V _{CC} - 2.2V, T _A = +25°C | 50 | 60 | | |
| | | -V _{CC} /2 ≤ V _{CM} ≤ V _{CC} - 2.2V | 39 | | | |
| Output Short-Circuit current | I _{SC} | | | 70 | | mA |
| Input-Voltage Noise Density | V _N | f = 10kHz, gain = 157V/V | | 54 | | nV/√Hz |
| Gain-Bandwidth Product | GBW | Gain = 0.2V/V | | 2.15 | | MHz |
| | | Gain = 1V/V | | | | |
| | | Gain = 157V/V | | 279 | | |
| Slew Rate | SR | | | 9 | | V/μs |
| Settling Time | t _S | To 1%, 2V output step | | 0.45 | | μs |
| Distortion | THD | f = 1kHz, V _{OUTA} = 2.5V _{P-P} | | 89 | | dB |
| Max Capacitive Load | C _{L(MAX)} | | | 1 | | nF |
| Output Swing | V _{OH} , V _{OL} | Voltage output high = V _{CC} - V _{OUTA} , voltage output low = V _{OUTA} - V _{GND} | | 25 | 60 | mV |
| OUTPUT AMPLIFIER CHARACTERISTICS | | | | | | |
| Input Bias Current | I _b | (Note 4) | | 1 | | pA |
| Input Offset Voltage (Note 2) | V _{OS-B} | T _A = +25°C | | 1.5 | 9 | mV |
| | | T _A = T _{MIN} to T _{MAX} | | | 15 | |
| Output Short-Circuit Current | I _{SC} | | | 70 | | mA |

Electrical Characteristics (continued)

($V_{CC} = 5V$, $V_{GND} = 0V$, $V_{INA+} = V_{INA-}$, Gain = 10V/V, $R_{OUTA} = R_{OUTB} = 1k\Omega$ to $V_{CC}/2$, $T_A = T_{MIN}$ to T_{MAX} , unless otherwise noted. Typical values are at $T_A = +25^\circ C$.) (Note 1)

| PARAMETER | SYMBOL | CONDITIONS | MIN | TYP | MAX | UNITS |
|---|---------------------|---|--------------------------------|------|---------|-----------------|
| Unity-Gain Bandwidth | UGBW | | | 2.2 | | MHz |
| Slew Rate | SR | | | 6.4 | | V/ μ s |
| Settling Time | t_S | To 1%, 2V output step | | 0.86 | | μ s |
| Input-Voltage Noise Density | V_N | | | 36 | | nV/ \sqrt{Hz} |
| Distortion | THD | f = 1kHz, $V_{OUTA} = 2.5V_{P-P}$, gain = -1V/V | | 90 | | dB |
| Max Capacitive Load | $C_{L(MAX)}$ | | | 1 | | nF |
| Output Swing | V_{OH} , V_{OL} | Voltage output high = $V_{CC} - V_{OUTB}$, voltage output low = $V_{OUTB} - V_{GND}$ | | 25 | 60 | mV |
| POWER SUPPLY | | | | | | |
| Supply Voltage Range | V_{CC} | Guaranteed by PSRR | 2.9 | | 5.5 | V |
| Power-Supply Rejection Ratio | PSRR | 1k Ω between OUTA and INB, 1k Ω between OUTB and INB, measured differentially between OUTA and OUTB | 60 | 80 | | dB |
| Supply Current | I_{CC} | OUTA and OUTB unloaded | | 3.4 | 6.7 | mA |
| Shutdown Supply Current | I_{SHDN} | Soft shutdown through SPI | | 13 | 24 | μ A |
| SPI CHARACTERISTICS | | | | | | |
| Input-Voltage Low | V_{IL} | | | | 0.8 | V |
| Input-Voltage High | V_{IH} | $V_{CC} = 5V$ | 2.0 | | | V |
| | | $V_{CC} = 3.3V$ | 1.65 | | | |
| Input Leakage Current | I_{IN} | | | | ± 1 | μ A |
| Input Capacitance | C_{IN} | | | 5 | | pF |
| SPI TIMING CHARACTERISTICS | | | | | | |
| SCLK Frequency | f_{SCLK} | (Note 5) | | | 5 | MHz |
| SCLK Period | t_{CP} | | 200 | | | ns |
| SCLK Pulse-Width High | t_{CH} | | 80 | | | ns |
| SCLK Pulse-Width Low | t_{CL} | | 80 | | | ns |
| \overline{CS} Fall to SCLK Rise Setup | t_{CSS} | | 80 | | | ns |
| \overline{CS} Fall to SCLK Rise Hold | t_{CSH} | | 20 + (0.5 $\times t_{CP}$) | | | ns |
| DIN to SCLK Setup | t_{DS} | | 55 | | | ns |
| DIN Hold after SCLK | t_{DH} | | 0 | | | ns |
| SCLK Rise to CS Fall Delay | t_{CS0} | | 20 | | | ns |
| \overline{CS} Rise to SCLK Rise Hold | t_{CS1} | | 80 | | | ns |
| \overline{CS} Pulse-Width High | t_{CSW} | | 200 | | | ns |

Note 1: All devices are 100% production tested at $T_A = +25^\circ C$. Temperature limits are guaranteed by design.

Note 2: The input offset voltage includes the effects of mismatches in the internal $V_{CC}/2$ resistor dividers.

Note 3: For gain of 0.25V/V, the input common-mode range is -1V to $V_{CC} - 2V$.

Note 4: The input current of a CMOS device is too low to be accurately measured on an ATE and is typically on the order of 1pA.

Note 5: Parts are functional with $f_{SCLK} = 10MHz$.

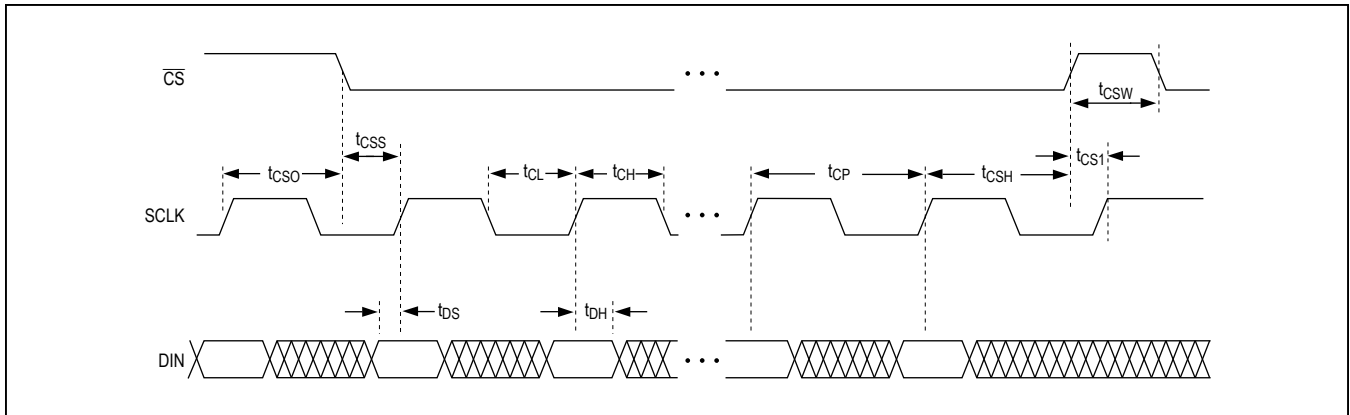
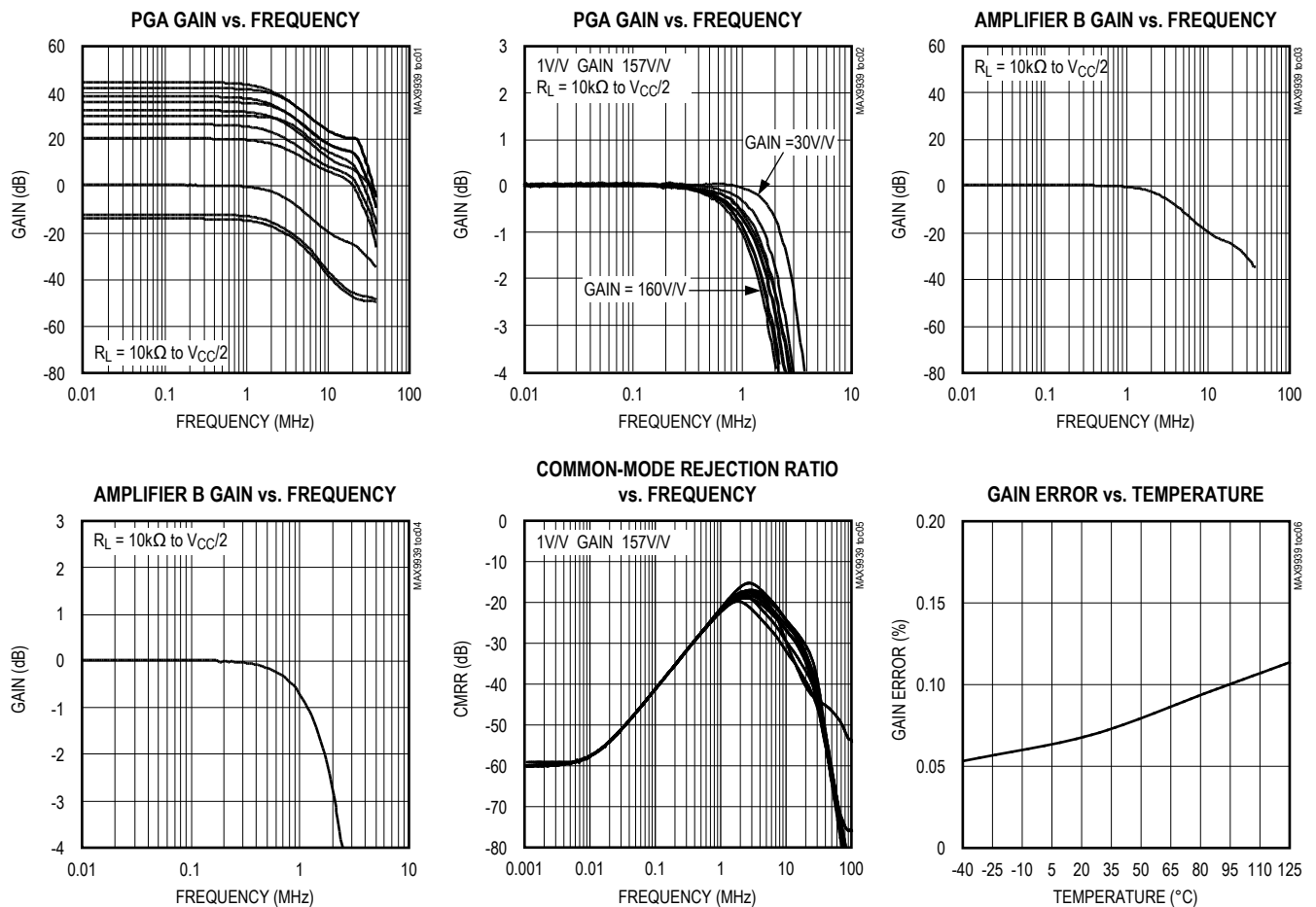

Figure 1. SPI Interface Timing Diagram

Typical Operating Characteristics

($V_{CC} = 5V$, $V_{GND} = 0V$, $V_{IN+} = V_{IN-} = 0V$, Gain = 10V/V, $R_{OUTA} = R_{OUTB} = 1k\Omega$ to $V_{CC}/2$, $T_A = +25^\circ C$, unless otherwise noted.)



Typical Operating Characteristics (continued)

(V_{CC} = 5V, V_{GND} = 0V, V_{IN+} = V_{IN-} = 0V, Gain = 10V/V, R_{OUTA} = R_{OUTB} = 1kΩ to V_{CC}/2, T_A = +25°C, unless otherwise noted.)

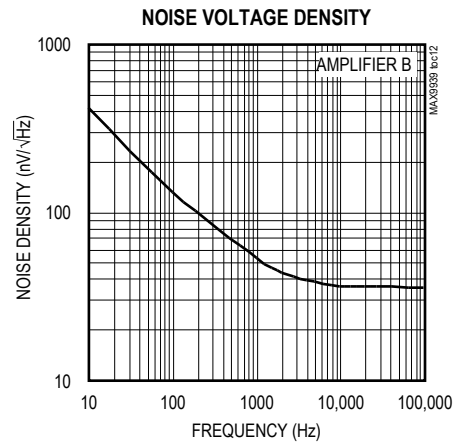
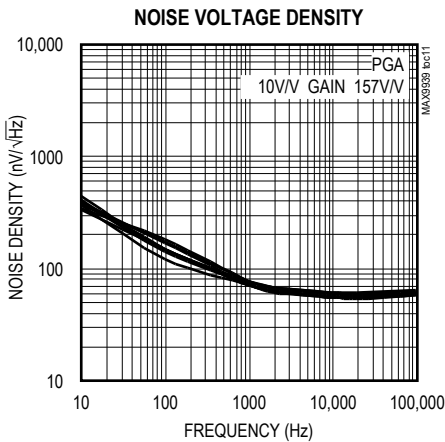
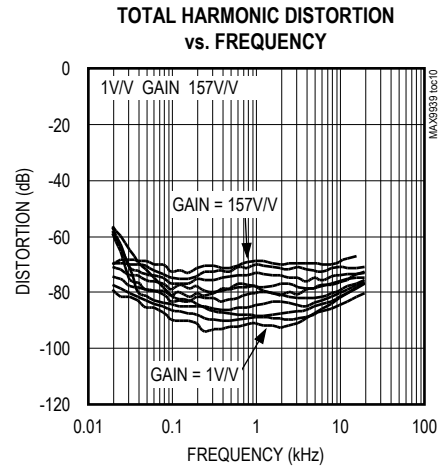
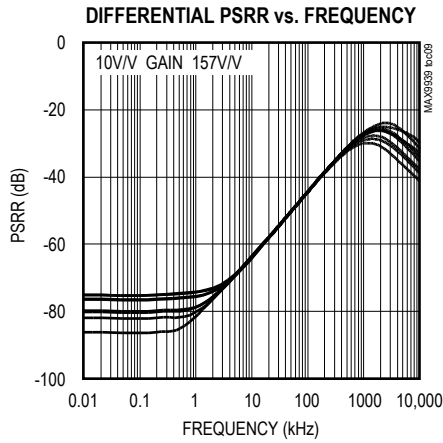
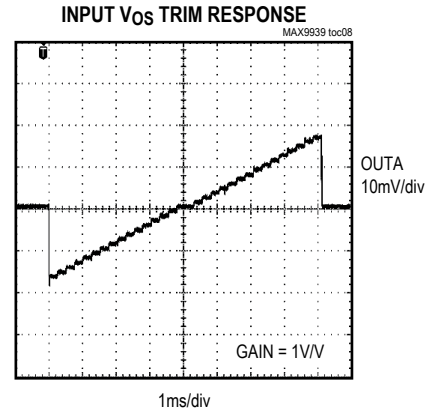
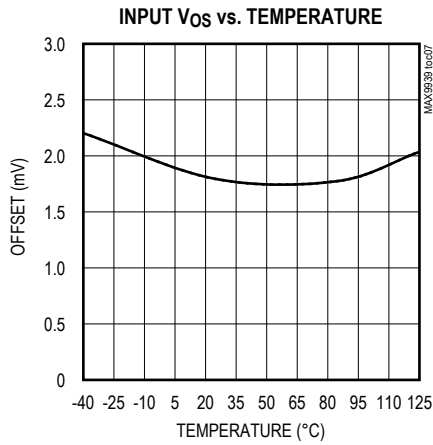

Typical Operating Characteristics (continued)

($V_{CC} = 5V$, $V_{GND} = 0V$, $V_{IN+} = V_{IN-} = 0V$, Gain = 10V/V, $R_{OUTA} = R_{OUTB} = 1k\Omega$ to $V_{CC}/2$, $T_A = +25^\circ C$, unless otherwise noted.)

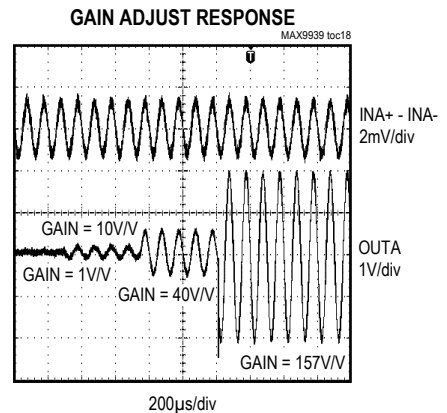
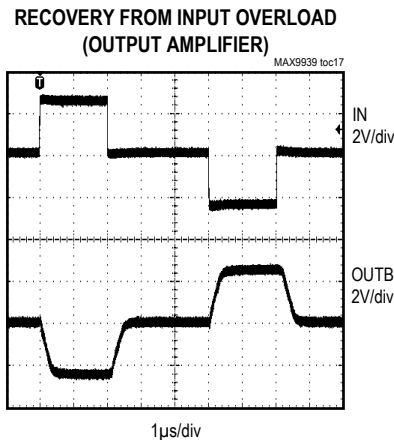
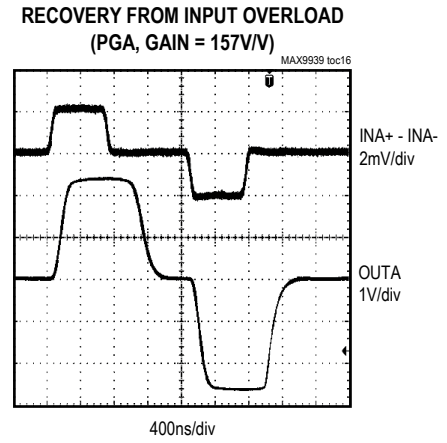
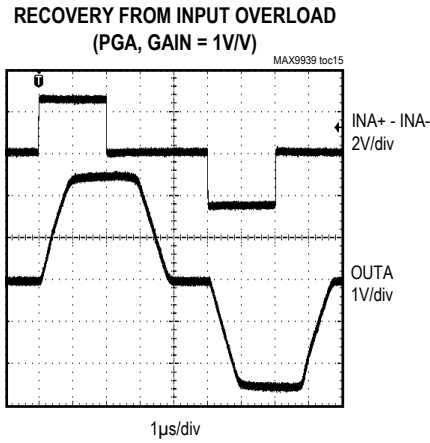
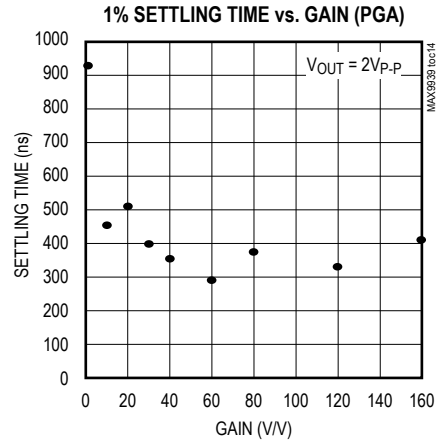
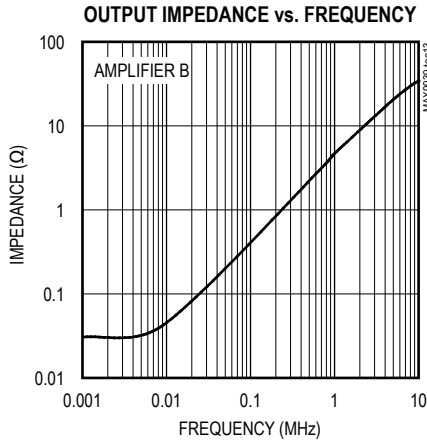

Typical Operating Characteristics (continued)

(V_{CC} = 5V, V_{GND} = 0V, V_{IN+} = V_{IN-} = 0V, Gain = 10V/V, R_{OUTA} = R_{OUTB} = 1kΩ to V_{CC}/2, T_A = +25°C, unless otherwise noted.)

COMMON-MODE REJECTION RESPONSE

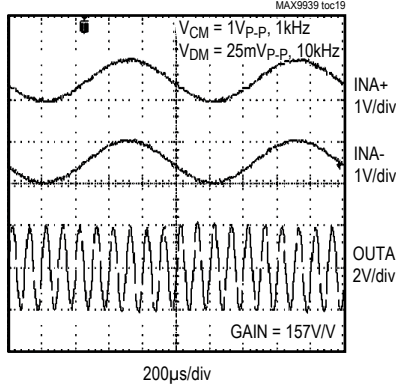

SHUTDOWN CURRENT vs. SUPPLY VOLTAGE

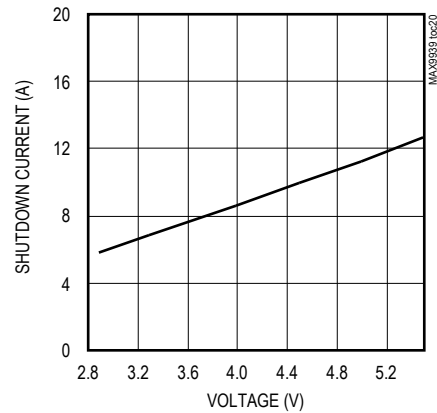

Pin Description

| PIN | NAME | FUNCTION |
|-----|------------------------|---|
| 1 | SCLK | Serial-Clock Input |
| 2 | DIN | Serial-Data Input. Data is clocked into the serial interface on the rising edge of SCLK. |
| 3 | GND | Ground |
| 4 | INA- | PGA Inverting Input |
| 5 | INA+ | PGA Noninverting Input |
| 6 | OUTB | Buffer Output |
| 7 | INB | Buffer Input |
| 8 | OUTA | PGA Output |
| 9 | V _{CC} | Power Supply. Bypass to GND with 0.1µF and 1µF capacitors. |
| 10 | $\overline{\text{CS}}$ | Active-Low Chip-Select Input. Drive $\overline{\text{CS}}$ low to enable the serial interface. Drive $\overline{\text{CS}}$ high to disable the serial interface. |

Detailed Description

The MAX9939 is a general-purpose PGA with input offset trim capability. Its gain and input offset voltage (V_{OS}) are SPI programmable. The device also includes an uncommitted output operational amplifier that can be used as either a high-order active filter or to provide a differential output. The device can be put into shutdown through SPI.

The gain of the amplifier is programmable between 0.2V/V and 157V/V (default gain is set to 1 V/V). The input offset

is programmable between ±17mV and can be used to regain output dynamic range in high gain settings. An input offset-voltage measurement mode enables input offset voltage to be calibrated out in firmware to obtain excellent DC accuracy.

The main amplifier accepts a differential input and provides a single-ended output. The relationship between the differential input and singled-ended output is given by the representative equation:

$$V_{OUTA} = V_{CC}/2 - \text{Gain} \times (V_{INA+} - V_{INA-}) + \text{Gain} \times V_{OS}$$

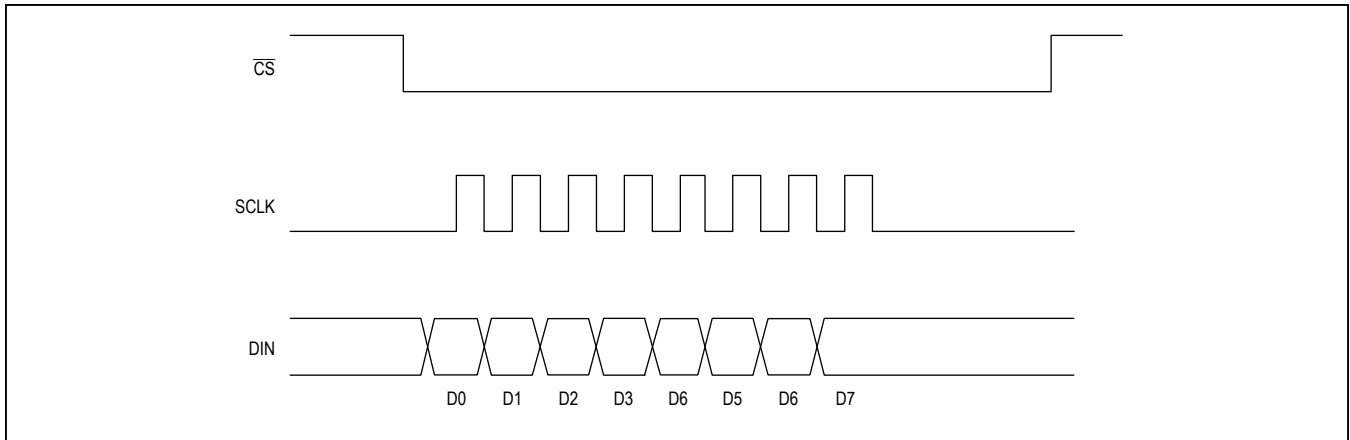

Figure 2. SPI Interface Timing Diagram (CPOL = CPHA = 0)

Architecture

The MAX9939 features three internal amplifiers as shown in the *Functional Diagram*. The first amplifier (amplifier LVL) is configured as a differential amplifier for differential to single-ended conversion with an input offset-voltage trim network. It has extremely high CMRR, gain accuracy, and very low temperature drift due to precise resistor matching. The output of this amplifier is level shifted to $V_{CC}/2$.

This amplifier is followed by a programmable-gain inverting amplifier (amplifier A) with programmable R_F and R_I resistors whose gain varies between $0.2V/V$ and $157V/V$. The output of this amplifier is biased at $V_{CC}/2$ and has extremely high gain accuracy and low temperature drift. The MAX9939 has an uncommitted op amp (amplifier B) whose noninverting input is referenced to $V_{CC}/2$. Its inverting input and output are externally accessible, allowing it to be configured either as an active filter or as a differential output.

A robust input ESD protection scheme allows input voltages at INA+ and INA- to reach $\pm 16V$ without damaging the MAX9939, thus making the part extremely attractive for use in front-ends that can be exposed to high voltages during fault conditions. In addition, its input-voltage range extends down to $-V_{CC}/2$ (e.g., $-2.5V$ when powered from a 5V single supply) allowing the MAX9939 to translate below ground signals to a 0V to 5V output signal. This feature simplifies interfacing ground-referenced signals with unipolar-input ADCs.

SPI-Compatible Serial Interface

The MAX9939 has a write-only interface, consisting of three inputs: the clock signal (SCLK), data input (DIN), and chip-select input (\overline{CS}). The serial interface works with

the clock polarity (CPOL) and clock phase (CPHA) both set to 0 (see Figure 1). Initiating a write to the MAX9939 is accomplished by pulling \overline{CS} low. Data is clocked in on the rising edge of each clock pulse, and is written LSB first. Each write to the MAX9939 consists of 8 bits (1 byte). Pull \overline{CS} high after the 8th bit has been clocked in to latch the data and before sending the next byte of instruction. Note that the internal register is not updated if \overline{CS} is pulled high before the falling edge of the 8th clock pulse.

Register Description

The MAX9939 consists of three registers: a shift register and two internal registers. The shift register accepts data and transfers it to either of the two internal registers. The two internal registers store data that is used to determine the gain, input offset voltage, and operating modes of the amplifier. The two internal registers are the Input V_{OS} Trim register and Gain register. The format of the 8-bit write to these registers is shown in Tables 1 and 2. Data is sent to the shift register LSB first.

Table 1. Input V_{OS} Trim Register

| D7 MSB | D6 | D5 | D4 | D3 | D2 | D1 | D0 LSB |
|--------|------|----|----|----|----|----|---------|
| SHDN | MEAS | V4 | V3 | V2 | V1 | V0 | SEL = 0 |

Table 2. Gain Register

| D7 MSB | D6 | D5 | D4 | D3 | D2 | D1 | D0 LSB |
|--------|------|----|----|----|----|----|---------|
| SHDN | MEAS | X | G3 | G2 | G1 | G0 | SEL = 1 |

X = Don't care.

SEL: The SEL bit selects which internal register is written to. Set SEL to 0 to write bits D5:D1 to the input V_{OS} trim register. Set SEL to 1 to write D4:D1 to the Gain register (D5 is don't care when SEL = 1).

SHDN: Set SHDN to 0 for normal operation. Set SHDN to 1 to place the device in a low-power 13μA shutdown mode. In shutdown mode, the outputs OUTA and OUTB are high impedance, however, the SPI decode circuitry is still active. Each instruction requires a write to the SHDN bit.

MEAS: The MAX9939 provides a means for measuring its own input offset voltage. When MEAS is set to 1, the INA- input is disconnected from the input signal path and internally shorted to INA+. This architecture thus allows the input common-mode voltage to be compensated at the application-specific input common-mode voltage of interest. The input offset voltage of the PGA is the output offset voltage divided by the programmed gain without any V_{OS} trim (i.e., V3:V0 set to 0):

$$V_{OS-INHERENT} = (V_{OUTA} - V_{CC}/2)/Gain$$

Program V_{OS} to offset V_{OS-INHERENT}. The input V_{OS} also includes the effect of mismatches in the resistor-dividers. Setting MEAS to 0 switches the inputs back to the signals on INA+ and INA-. Each instruction requires a write to the MEAS bit.

Programming Gain

The PGA's gain is set by the bits G3:G0 in the Gain register. Table 3 shows the relationship between the bits G3:G0 and the amplifier's gain. The slew rate and small-signal bandwidth (SSBW) of the PGA depend on its gain setting as shown in Table 3.

Table 3. Gain

| G3:G0 | GAIN (V/V) | SLEW RATE (V/μs) | SMALL-SIGNAL BANDWIDTH (MHz) |
|-------|-------------------------------|------------------|------------------------------|
| 0000 | 1 | 2.90 | 2.15 |
| 0001 | 10 | 8.99 | 2.40 |
| 0010 | 20 | 8.70 | 1.95 |
| 0011 | 30 | 12.80 | 3.40 |
| 0100 | 40 | 12.50 | 2.15 |
| 0101 | 60 | 13.31 | 2.60 |
| 0110 | 80 | 12.15 | 1.91 |
| 0111 | 120 | 18.53 | 2.30 |
| 1000 | 157 | 16.49 | 1.78 |
| 1001 | 0.2 (V _{CC} = 5V) | 2.86 | 1.95 |
| | 0.25 (V _{CC} = 3.3V) | | |
| 1010 | 1 | 2.90 | 2.15 |

Programming Input Offset Voltage (V_{OS})

The input offset voltage is set by the bits V4:V0 in the Input Offset Voltage Trim register. Bit V4 determines the polarity of the offset. Setting V4 to 0 makes the offset positive, while setting V4 to 1 makes the offset negative. Table 4 shows the relationship between V3:V0 and V_{OS}.

To determine the effect of V_{OS} at the output of the amplifier for gains other than 1, use the following formula:

$$V_{OUTA} = V_{CC}/2 + Gain \times (V_{OS-INHERENT} + V_{OS})$$

where V_{OS-INHERENT} is the inherent input offset voltage of the amplifier, which can be measured by setting MEAS to 1.

Applications Information

Use of Output Amplifier as Active Filter

The output amplifier can be configured as a multiple-feedback active filter as shown in Figure 3, which traditionally has better stopband attenuation characteristics than Sallen-Key filters. These filters also possess inherently better distortion performance since there are no common-mode induced effects (i.e., the common-mode voltage of the operational amplifier is always fixed at V_{CC}/2 instead of it being signal dependent such as in Sallen-Key filters). Choose external resistors and capacitors to create lowpass, bandpass, or highpass filters.

Table 4. Input Offset-Voltage Trim

| INPUT OFFSET VOLTAGE (V4 = 0 TRIMS POSITIVE, V4 = 1 TRIMS NEGATIVE) | |
|--|----------------------|
| V3:V0 | V _{OS} (mV) |
| 0000 | 0 |
| 0001 | 1.3 |
| 0010 | 2.5 |
| 0011 | 3.8 |
| 0100 | 4.9 |
| 0101 | 6.1 |
| 0110 | 7.3 |
| 0111 | 8.4 |
| 1000 | 10.6 |
| 1001 | 11.7 |
| 1010 | 12.7 |
| 1011 | 13.7 |
| 1100 | 14.7 |
| 1101 | 15.7 |
| 1110 | 16.7 |
| 1111 | 17.6 |

Differential-Input, Differential-Output PGA

The output amplifier can be configured so that the MAX9939 operates as a differential-input, differential-output programmable gain amplifier. As shown in Figure 4, use a 10k Ω resistor between OUTA and INB, and between INB and OUTB. Such a differential-output configuration is ideal for use in low-voltage applications that can benefit from the 2X output voltage dynamic range when compared to single-ended output format.

Use of Output Operational Amplifier as TIA

CMOS inputs on the output op amp makes it ideal for use as an input transimpedance amplifier (TIA) in certain current-output sensor applications. In such a situation, keep in mind that the inverting input operates at fixed voltage of $V_{CC}/2$. Use a high-value resistor as a feedback gain element, and use a feedback capacitor in parallel with this resistor if necessary to aid amplifier stability in the presence of high photodiode or cable capacitance. The output of this TIA can be routed to INA+ or INA- for further processing and signal amplification.

Power-Supply Bypassing

Bypass V_{CC} to GND with a 0.1 μ F capacitor in parallel with a 1 μ F low-ESR capacitor placed as close as possible to the MAX9939.

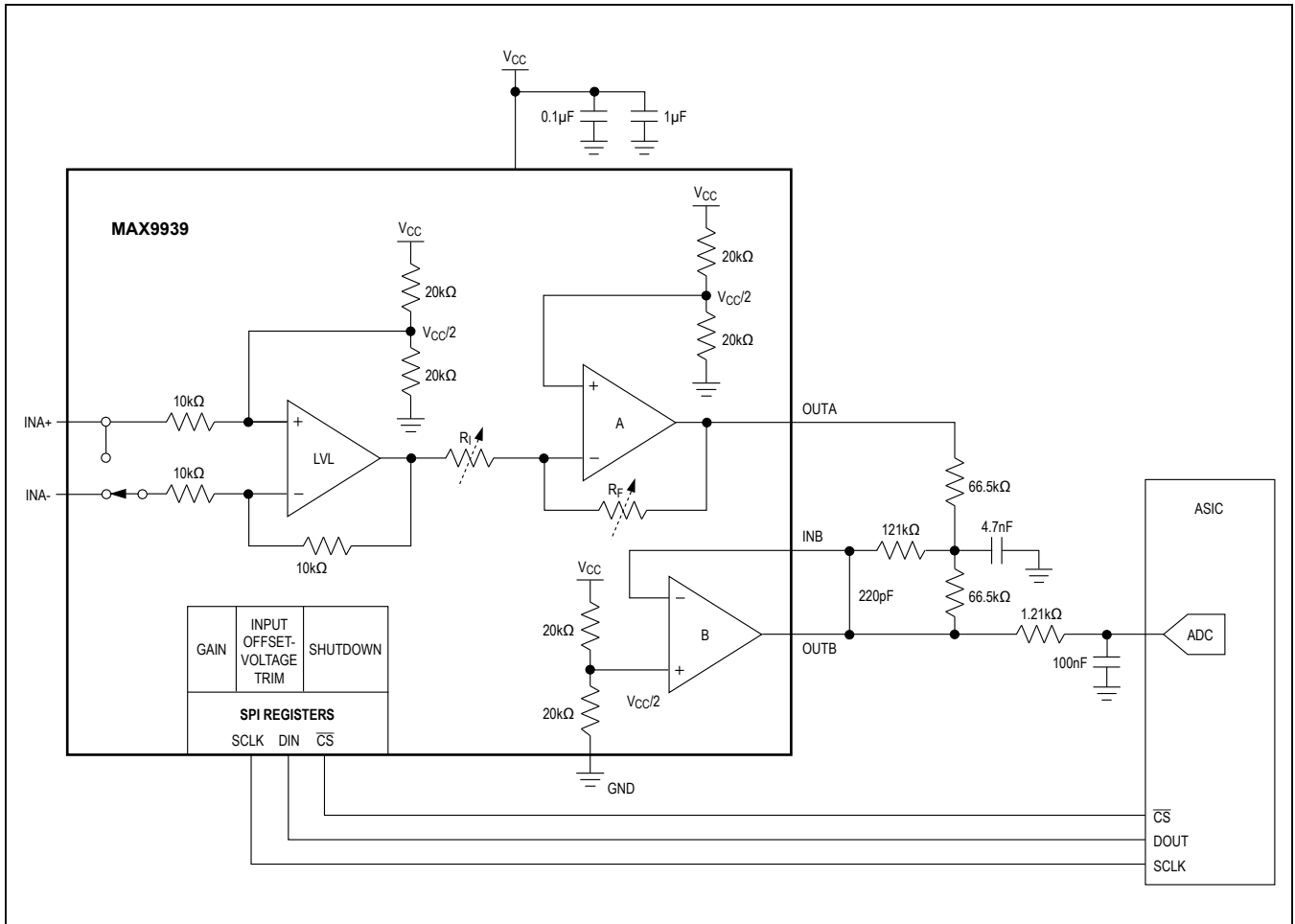

Figure 3. Using the MAX9939 Output Amplifier as an Anti-Aliasing Filter (Corner Frequency = 1.3kHz) to Maximize Nyquist Bandwidth

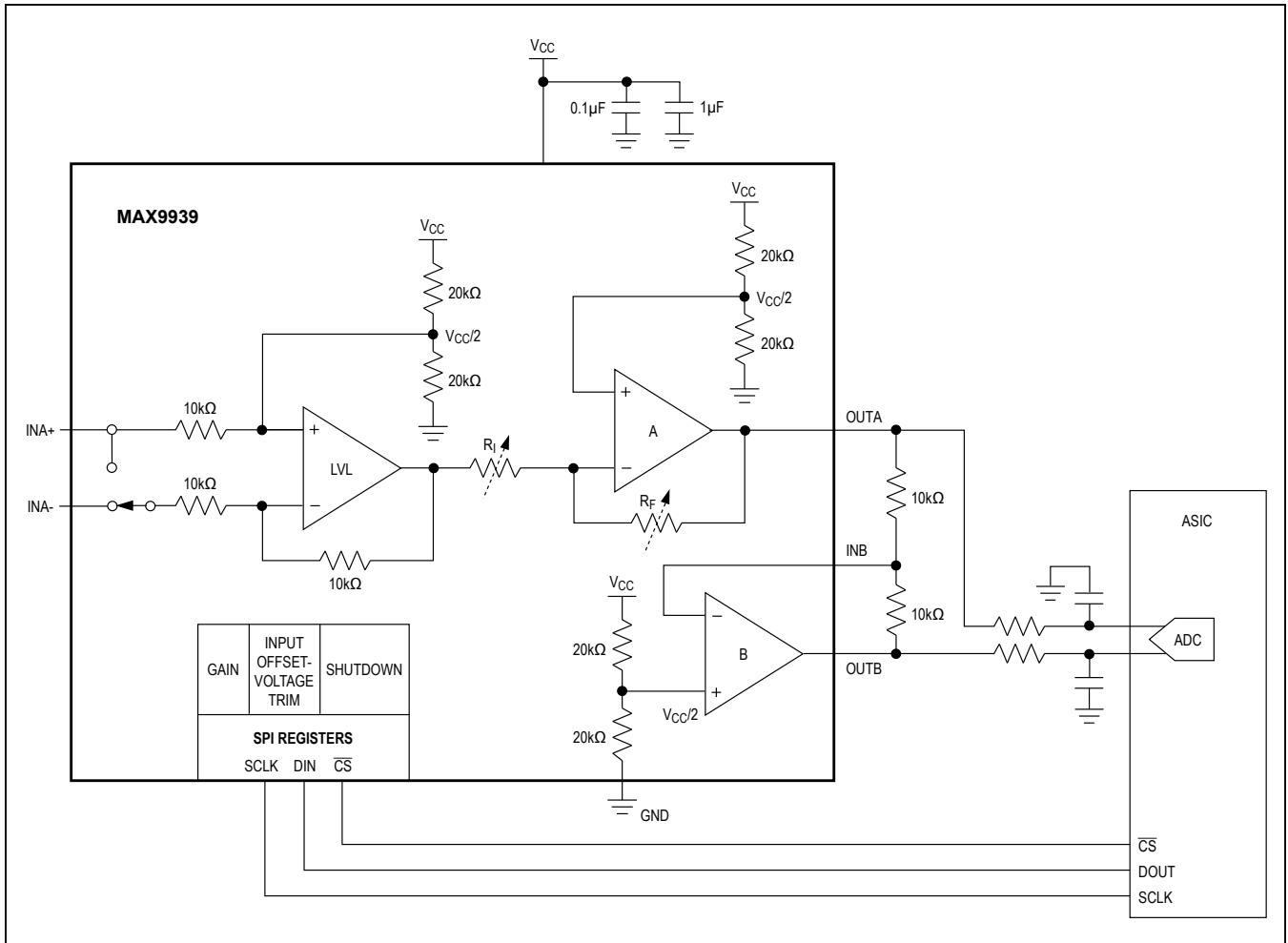
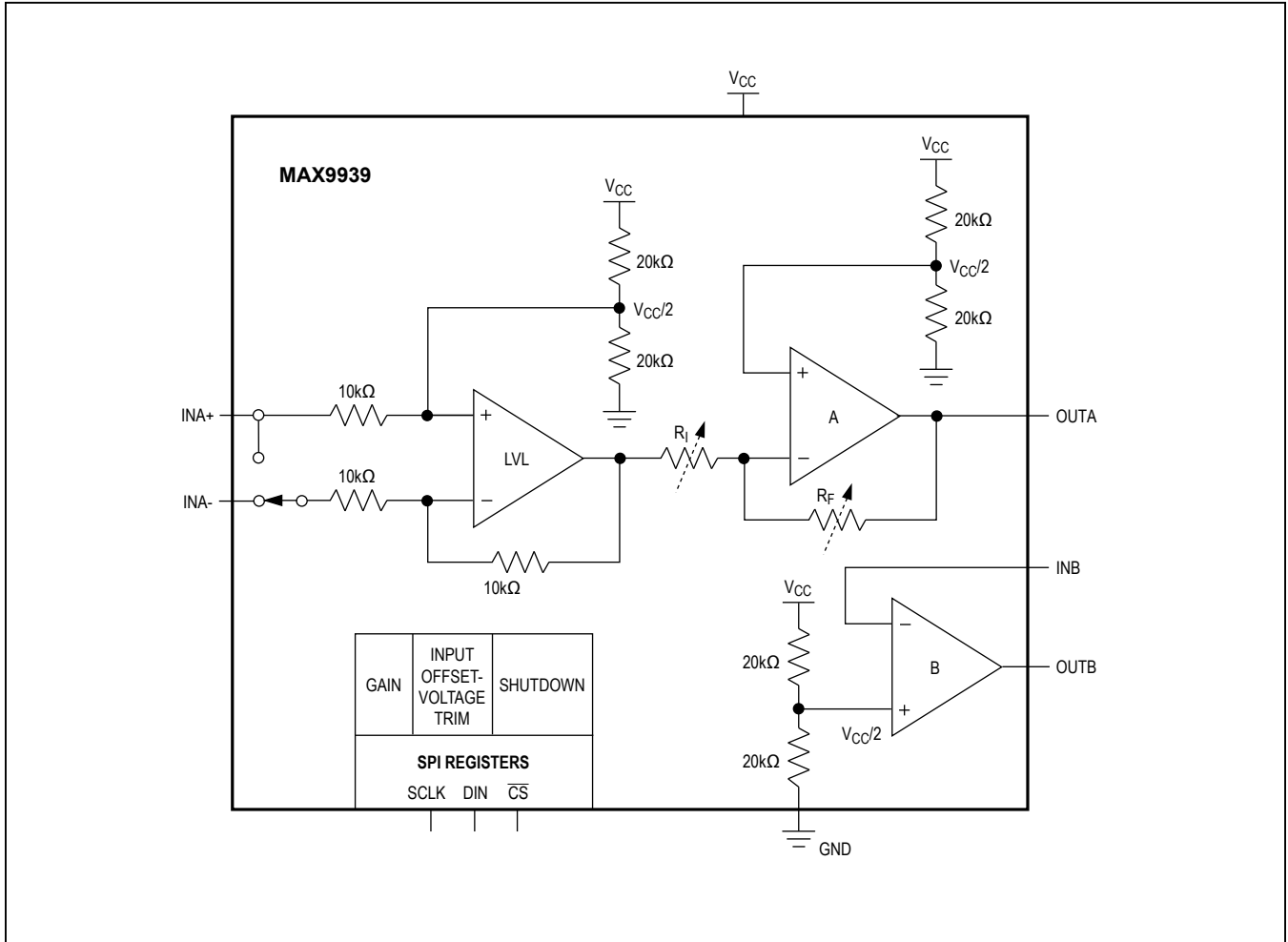

Figure 4. Using the MAX9939 as a Differential-Input, Differential-Output PGA

Chip Information

PROCESS: BiCMOS

Functional Diagram



Package Information

For the latest package outline information and land patterns (footprints), go to www.maximintegrated.com/packages. Note that a "+", "#", or "-" in the package code indicates RoHS status only. Package drawings may show a different suffix character, but the drawing pertains to the package regardless of RoHS status.

| PACKAGE TYPE | PACKAGE CODE | OUTLINE NO. | LAND PATTERN NO. |
|--------------|--------------|-------------------------|-------------------------|
| 10 μMAX | U10+2 | 21-0061 | 90-0330 |

TOP VIEW

BOTTOM VIEW

FRONT VIEW

SIDE VIEW

| DIM | INCHES | | MILLIMETERS | |
|-----|------------|--------|-------------|-------|
| | MIN | MAX | MIN | MAX |
| A | — | 0.043 | — | 1.10 |
| A1 | 0.002 | 0.006 | 0.05 | 0.15 |
| A2 | 0.030 | 0.037 | 0.75 | 0.95 |
| D1 | 0.116 | 0.120 | 2.95 | 3.05 |
| D2 | 0.114 | 0.118 | 2.89 | 3.00 |
| E1 | 0.116 | 0.120 | 2.95 | 3.05 |
| E2 | 0.114 | 0.118 | 2.89 | 3.00 |
| H | 0.187 | 0.199 | 4.75 | 5.05 |
| L | 0.0157 | 0.0275 | 0.40 | 0.70 |
| L1 | 0.037 REF | | 0.940 REF | |
| b | 0.007 | 0.0106 | 0.177 | 0.270 |
| e | 0.0197 BSC | | 0.500 BSC | |
| c | 0.0035 | 0.0078 | 0.090 | 0.200 |
| S | 0.0196 REF | | 0.498 REF | |
| α | 0° | 6° | 0° | 6° |

Pkg Codes: U10-2; U10CN-1

NOTES:

- D&E DO NOT INCLUDE MOLD FLASH.
- MOLD FLASH OR PROTRUSIONS NOT TO EXCEED 0.15mm (.006").
- CONTROLLING DIMENSION: MILLIMETERS.
- COMPLIES TO JEDEC MO-187, LATEST REVISION, VARIATION BA.
- MARKING SHOWN IS FOR PKG. ORIENTATION ONLY.
- ALL DIMENSIONS APPLY TO BOTH LEADED (-) AND PbFREE (+) PKG. CODES.

—DRAWING NOT TO SCALE—

maxim integrated.

TITLE:
PACKAGE OUTLINE, 10L μMAX/μSOP

| | | |
|----------|---------------------------------|---------------|
| APPROVAL | DOCUMENT CONTROL NO. 21-0061 | REV. L 1/1 |
|----------|---------------------------------|---------------|

Revision History

| REVISION NUMBER | REVISION DATE | DESCRIPTION | PAGES CHANGED |
|-----------------|---------------|-------------------------------------|---------------|
| 0 | 11/08 | Initial release | — |
| 1 | 2/09 | Corrected gain value in Table 3 | 9 |
| 2 | 12/10 | Modified Figure 2 | 8 |
| 3 | 12/12 | Added the MAX9939AUB/V+T | 1 |
| 4 | 8/19 | Updated <i>Detailed Description</i> | 7 |

For pricing, delivery, and ordering information, please visit Maxim Integrated's online storefront at <https://www.maximintegrated.com/en/storefront/storefront.html>.

Maxim Integrated cannot assume responsibility for use of any circuitry other than circuitry entirely embodied in a Maxim Integrated product. No circuit patent licenses are implied. Maxim Integrated reserves the right to change the circuitry and specifications without notice at any time. The parametric values (min and max limits) shown in the Electrical Characteristics table are guaranteed. Other parametric values quoted in this data sheet are provided for guidance.

Данный компонент на территории Российской Федерации

Вы можете приобрести в компании MosChip.

Для оперативного оформления запроса Вам необходимо перейти по данной ссылке:

<http://moschip.ru/get-element>

Вы можете разместить у нас заказ для любого Вашего проекта, будь то серийное производство или разработка единичного прибора.

В нашем ассортименте представлены ведущие мировые производители активных и пассивных электронных компонентов.

Нашей специализацией является поставка электронной компонентной базы двойного назначения, продукции таких производителей как XILINX, Intel (ex.ALTERA), Vicor, Microchip, Texas Instruments, Analog Devices, Mini-Circuits, Amphenol, Glenair.

Сотрудничество с глобальными дистрибьюторами электронных компонентов, предоставляет возможность заказывать и получать с международных складов практически любой перечень компонентов в оптимальные для Вас сроки.

На всех этапах разработки и производства наши партнеры могут получить квалифицированную поддержку опытных инженеров.

Система менеджмента качества компании отвечает требованиям в соответствии с ГОСТ Р ИСО 9001, ГОСТ РВ 0015-002 и ЭС РД 009

Офис по работе с юридическими лицами:

105318, г.Москва, ул.Щербаковская д.3, офис 1107, 1118, ДЦ «Щербаковский»

Телефон: +7 495 668-12-70 (многоканальный)

Факс: +7 495 668-12-70 (доб.304)

E-mail: info@moschip.ru

Skype отдела продаж:

moschip.ru

moschip.ru_4

moschip.ru_6

moschip.ru_9