

AXL E S3 DIO16 M12 6P

**Axioline E Sercos device, plastic housing,
16 freely configurable inputs or outputs,
24 V DC, M12 fast connection technology**



Data sheet
8562_en_03

© PHOENIX CONTACT 2015-09-17

1 Description

The Axioline E device is designed for use within a Sercos[®] network.

It is used to acquire and output digital signals.

Sercos features

- Connection to Sercos network using M12 connectors (D-coded)
- Transmission speed 100 Mbps
- Minimum cycle time of 250 μ s
- 2 Ethernet ports (with integrated switch)
- Sercos communication profiles:
SCP_FixCFG_02hex, SCP_Diag, SCP_NRTPC, SCP_WDCon, SCP_Sync_02hex, SCP_SIP, SCP_TFTP, SPC_Cyc
- Device description by means of SDDml
- Firmware can be updated
- Integrated web server for web-based management

General features

- Connection of digital sensors and actuators to M12 connectors (A-coded)
- Diagnostic and status indicators
- Short-circuit and overload protection of the sensor supply
- IP65/67 degree of protection



This data sheet is only valid in association with the associated user manual.



Make sure you always use the latest documentation.
It can be downloaded from the product at phoenixcontact.net/products.

2 Table of contents

1 Description 1

2 Table of contents 2

3 Ordering data 3

4 Technical data 4

5 Internal circuit diagram 7

6 Pin assignment 8

7 Connection example 10

8 Connection notes 10

9 Configuration via rotary encoding switch 11

10 Local status and diagnostic indicators 12

11 Sercos realtime connections 15

12 Sercos profiles, classes and function groups 15

13 Sercos parameter 16

14 Password (IDN S-0-00267) 19

15 IP address assignment 19

16 Monitoring connection (connection setup, IDN S-0-1050.x.1) 19

17 Electronic rating plate (IDNs S-0-1300.x.y) 19

18 Substitute value behavior 20

19 Diagnostics: I/O and channel errors 21

20 Mapping the I/Os to Sercos 21

21 Delivery state/default settings 23

22 Restoring the default settings 23

23 Firmware started 23

24 Firmware update 23

25 WBM - Web-based management 23

26 Device description file (SDDml) 23

3 Ordering data

Description	Type	Order No.	Pcs. / Pkt.
Axioline E Sercos device in a plastic housing with 16 freely configurable inputs or outputs, 24 V DC, M12 fast connection technology	AXL E S3 DIO16 M12 6P	2701545	1

Accessories	Type	Order No.	Pcs. / Pkt.
An M12 screw plug for the unoccupied M12 sockets of the sensor/actuator cable, boxes and flush-type connectors (Protection and sealing elements)	PROT-M12	1680539	5
Snap-in markers, Sheet, white, unlabeled, can be labeled with: THERMOMARK CARD, BLUEMARK CLED, BLUEMARK LED, TOPMARK LASER, Mounting type: snapped into marker carrier, Lettering field: 7 x 10 mm (Marking)	UCT-EM (7X10)	0830765	10

Documentation	Type	Order No.	Pcs. / Pkt.
User manual, English, Axioline E: system and installation	UM EN AXL E SYS INST	-	-
Application note, English: Updating the firmware of AXL E devices using the Windows Explorer	AH EN FIRMWARE UPDATE AXL E	-	-
Quick start guide, English: Startup of Axioline E Sercos devices with IndraWorks	UM QS EN AXL E S3 INDRAWORKS	-	-

Additional ordering data

For additional accessories, visit phoenixcontact.net/products.

4 Technical data

Dimensions (nominal sizes in mm)



Width	60 mm
Height	185 mm
Depth	30.5 mm
Note on dimensions	The height is 212 mm including fixing clips.

General data

Housing material	Pocan®
Color	anthracite
Weight	480 g
Ambient temperature (operation)	-25 °C ... 60 °C



CAUTION: Risk of burns

If the device is used at an ambient temperature above 50°C, the contact temperature of metal surfaces may exceed 70°C.

Ambient temperature (storage/transport)	-25 °C ... 85 °C
Permissible humidity (operation)	5 % ... 95 %
Permissible humidity (storage/transport)	5 % ... 95 %
Air pressure (operation)	70 kPa ... 106 kPa (up to 3000 m above sea level)
Air pressure (storage/transport)	70 kPa ... 106 kPa (up to 3000 m above sea level)
Degree of protection	IP65/IP67
Protection class	III, IEC 61140, EN 61140, VDE 0140-1

Connection data

Connection method	M12 connector
-------------------	---------------

Interface Sercos

Number	2
Connection method	M12 connectors, D-coded
Designation connection point	Copper cable
Number of positions	4
Transmission speed	100 MBit/s (with auto negotiation)

Sercos

Equipment type	Sercos slave
Device profile	FSP_IO
Sercos protocols	Sercos, S/IP
Additional protocols	HTTP, TFTP, FTP
Specification	Sercos specification 1.1.2

Supply: Module electronics, sensors, and actuators (U_S)

Connection method	M12 connector (T-coded)
Number of positions	4
Supply voltage	24 V DC
Nominal supply voltage range	18 V DC ... 31.2 V DC (including all tolerances, including ripple)
Typical current consumption	190 mA ±15 % (at 24 V DC)
Current consumption	max. 12 A

Supply: Actuators (U_A) for additional devices

Connection method	M12 connector (T-coded)
Number of positions	4
Supply voltage	24 V DC
Nominal supply voltage range	18 V DC ... 31.2 V DC (including all tolerances, including ripple)
Typical current consumption	3 mA ±15 % (at 24 V DC)
Current consumption	max. 12 A

Digital inputs

Number of inputs	16 (EN 61131-2 types 1 and 3)
Connection method	M12 connector, double occupancy
Connection method	2, 3, 4-wire
Nominal input voltage	24 V DC
Nominal input current	typ. 3 mA
Sensor current per channel	typ. 0.75 mA (from U _S)
Total sensor current	max. 1.2 A (per device)
Input voltage range "0" signal	-30 V DC ... 5 V DC
Input voltage range "1" signal	11 V DC ... 30 V DC
Input filter time	< 1000 μs
Permissible conductor length to the sensor	30 m
Overload protection, short-circuit protection of sensor supply	Yes

Digital outputs

Number of outputs	16
Connection method	M12 connector, double occupancy
Connection method	2, 3-wire
Nominal output voltage	24 V DC (from voltage U _S)
Output voltage range	18 V DC ... 31.2 V DC
Maximum output current per channel	0.5 A
Nominal load, ohmic	12 W (48 Ω; with nominal voltage)
Nominal load, inductive	12 VA (1.2 H; 48 Ω; with nominal voltage)
Signal delay	max. 150 μs (when switched on) max. 200 μs (when switched off)
Switching frequency	max. 5500 per second (with at least 50 mA load current)

Digital outputs

Switching frequency	max. 1 per second (with inductive load)
Limitation of the voltage induced on circuit interruption	-28 V ... -17 V
Output voltage when switched off	max. 1 V
Output current when switched off	max. 20 µA
Behavior with overload	Auto restart
Reverse voltage resistance to short pulses	Reverse voltage proof
Overcurrent shut-down	min. 0.7 A
Overload protection, short-circuit protection of outputs	Electronic

Electrical isolation/isolation of the voltage areas

Test section	Test voltage
24 V supply (communications power/sensor supply, digital inputs/outputs)/ bus connection (Ethernet 1)	500 V AC, 50 Hz, 1 min
24 V supply (communications power/sensor supply, digital inputs/outputs)/ bus connection (Ethernet 2)	500 V AC, 50 Hz, 1 min
24 V supply (communications power/sensor supply, digital inputs/outputs)/ FE	500 V AC, 50 Hz, 1 min
Bus connection (Ethernet 1)/FE	500 V AC, 50 Hz, 1 min
Bus connection (Ethernet 2)/FE	500 V AC, 50 Hz, 1 min
Bus connection (Ethernet 1)/bus connection (Ethernet 2)	500 V AC, 50 Hz, 1 min
24 V supply (actuator supply)/24 V supply (communications power and sensor supply, digital inputs/outputs)	500 V AC, 50 Hz, 1 min
24 V supply (actuator supply)/bus connection (Ethernet 1)	500 V AC, 50 Hz, 1 min
24 V supply (actuator supply)/bus connection (Ethernet 2)	500 V AC, 50 Hz, 1 min
24 V supply (actuator supply)/FE	500 V AC, 50 Hz, 1 min

Mechanical tests

Vibration resistance in acc. with EN 60068-2-6/IEC 60068-2-6	5g
Shock in acc. with EN 60068-2-27/IEC 60068-2-27	30g, 11 ms period, half-sine shock pulse
Continuous shock according to EN 60068-2-27/IEC 60068-2-27	10g

Conformance with EMC Directive 2004/108/EC

Noise immunity test in accordance with EN 61000-6-2

Electrostatic discharge (ESD) EN 61000-4-2/IEC 61000-4-2	Criterion B; 6 kV contact discharge, 8 kV air discharge
Electromagnetic fields EN 61000-4-3/IEC 61000-4-3	Criterion A; Field intensity: 10 V/m
Fast transients (burst) EN 61000-4-4/IEC 61000-4-4	Criterion B, 2 kV
Transient surge voltage (surge) EN 61000-4-5/IEC 61000-4-5	Criterion B; DC supply lines: ±0.5 kV/±0.5 kV (symmetrical/asymmetrical)
Conducted interference EN 61000-4-6/IEC 61000-4-6	Criterion A; Test voltage 10 V

Noise emission test as per EN 61000-6-4

Radio interference properties EN 55022	Class A
--	---------

Approvals

For the latest approvals, please visit phoenixcontact.net/products.

5 Internal circuit diagram

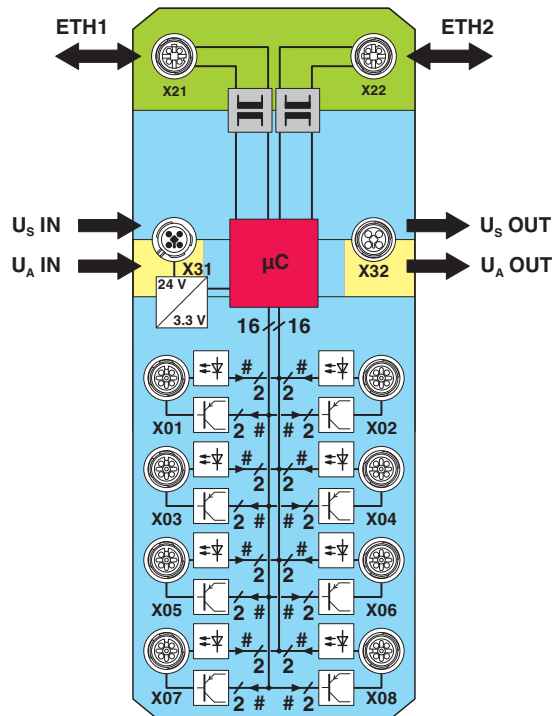

Key:

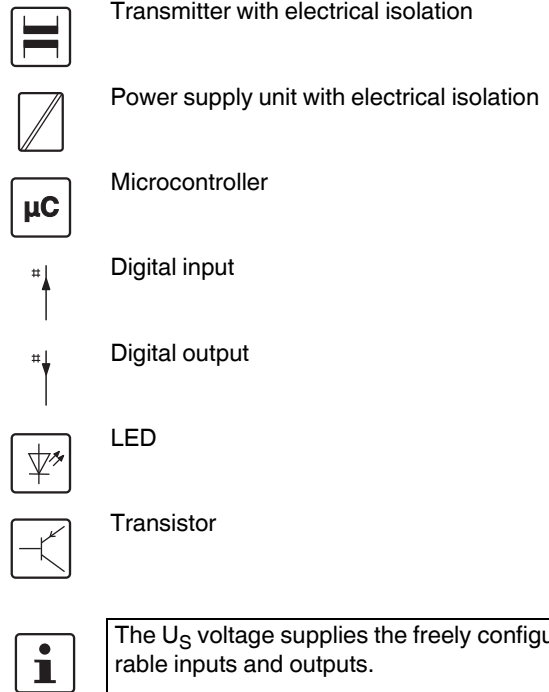

Figure 1 Internal wiring of connections

Key:

Green area:	Network
Blue area:	U_S
Yellow area:	U_A

6 Pin assignment

6.1 Sercos and power supply connection



Figure 2 Connections for Sercos and power supply

Designation	Meaning
Port 1 (X21)	Ethernet port 1
Port 2 (X22)	Ethernet port 2
U _S IN (X31)	Power supply IN (logic, sensors and actuators)
U _A IN (X31)	Power Supply IN (actuators) for additional devices
U _S OUT (X32)	Power supply OUT for additional devices
U _A OUT (X32)	Power supply OUT for additional devices



Ground the device by means of the mounting screws.

6.2 Sercos pin assignment

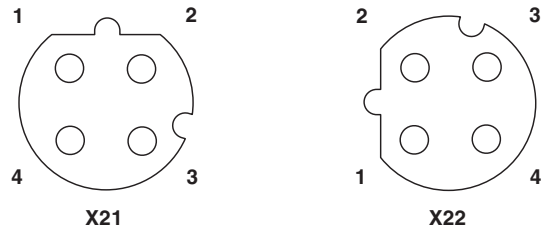

Figure 3 Pin assignment, D-coded

Pin	Ethernet port 1 (X21)	Ethernet port 2 (X22)
1	TX+	TX+
2	RX+	RX+
3	TX-	TX-
4	RX-	RX-



The shield is connected to FE in the device.



The thread is used for additional shielding.

6.3 Pin assignment of the power supply U_S/U_A

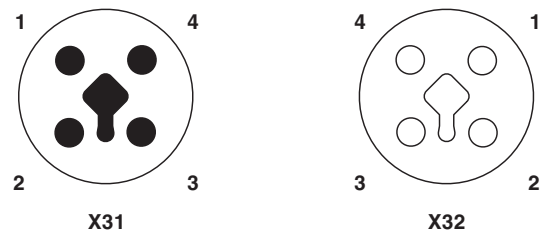

Figure 4 Pin assignment of the power supply, T-coded

Pin	IN	OUT	Conductor colors
1	+24 V DC (U _S)	+24 V DC (U _S)	Brown
2	GND (U _A)	GND (U _A)	White
3	GND (U _S)	GND (U _S)	Blue
4	+24 V DC (U _A)	+24 V DC (U _A)	Black

6.4 Connecting inputs and outputs

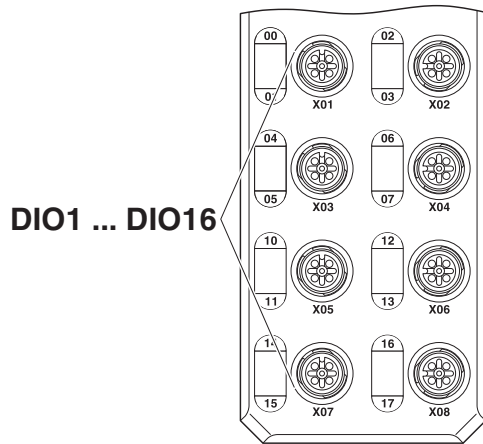

Figure 5 Input and output connections

Designation	Meaning
DIO1 ... DIO16 (X01 ... X08)	Inputs/outputs 1 ... 16

6.5 Pin assignment of the inputs and outputs



Figure 6 Pin assignment of the inputs and outputs, A-coded

Pin	Input/output socket
1	+24 V DC (U_S)
2	Input/output 2, 4, 6, ... 16
3	GND
4	Input/output 1, 3, 5, ... 15
5	FE

7 Connection example

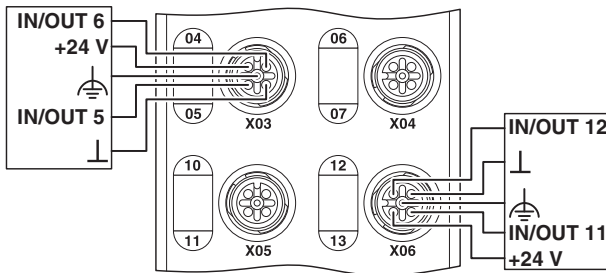

Figure 7 Example of connection of sensors and actuators

8 Connection notes



Note: data corruption or loss

Implement the FE connection using mounting screws, in order to ensure immunity to interference.



NOTE: device damage

To ensure IP65/IP67 protection, cover unused sockets with protective caps.



NOTE: Damage to the electronics

Only supply the sensors with the voltage U_S provided at the terminal points.



NOTE: Damage to the electronics

Observe the correct polarity of the supply voltages U_S and U_A in order to prevent damage to the device.



NOTE: Malfunction

When connecting the sensors and actuators, observe the assignment of the connections to the Sercos input and output data.



Secure the device to a level surface or to a profile. Do not use this device to bridge gaps, in order to prevent forces being transmitted via the device.



Use standard M5 screws with toothed lock washer and self-locking nuts. Observe the maximum torque of the screws.

9 Configuration via rotary encoding switch

You can configure the address assignment and other functions using rotary encoding switches.

After modifying the switch position, restart the device, as the modification to the switch position does not take effect during operation.

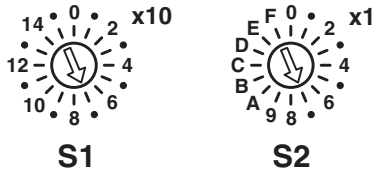

Figure 8 Rotary encoding switch

The code results from the sum of S1 x 10 plus S2 x 1. The image shows the code and therefore Sercos address 77 (7 x 10 + 7).

S1	S2	Code	Function
0	0	00	Remote address assignment (Default)
0 ... 15	0 ... 09	01 ... 159	Manual address assignment
0	F	0F	Resetting to the default settings
Other			Reserved

9.1 Manual address assignment

Switch position 01 ... 159

The devices are automatically assigned addresses by the Sercos master via remote address assignment as standard. Set the Sercos address manually with this switch position. Remote address assignment, e.g., via an engineering tool, is deactivated.

9.2 Resetting to the default settings

Switch position 0F

All settings are reset to the delivery state.



The device is ready for operation after powering up, as soon as the RDY LED lights up green.

A connection to the device however cannot be established in this switch position. As soon as the RDY LED lights up green, a new switch position can be selected on the rotary encoding switch and the device can be restarted.

9.3 Reserved/invalid switch position

The device starts with the previous settings, e.g., with the settings that were valid before the device was restarted.

10 Local status and diagnostic indicators

10.1 Indicators for Ethernet ports and power supply

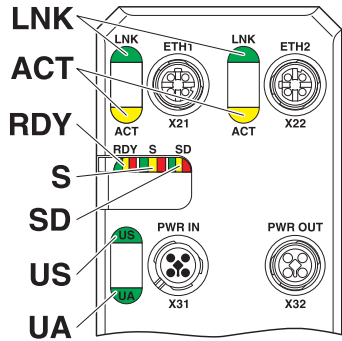

Figure 9 Indicators for Ethernet ports and power supply

Designation	Color	Meaning	State	Description
LNK 1/2	Green	Link	Green ON	Connection present at port 1/2.
			OFF	Connection not present at port 1/2.
ACT 1/2	Yellow	Activity	Yellow ON	Data transmission present at port 1/2.
			OFF	Data transmission not present at port 1/2.
RDY	Green/ yellow/ red	Ready	Green ON	Device is ready for operation.
			Yellow flashing	Firmware update is being performed.
			Flashing green/ yellow	Over- or undervoltage at U_S
				Temperature of the device is in the critical area. And red US LED: sensor supply overload
			Red ON	Rotary encoding switches are set to an invalid/reserved position.
OFF	Device is not ready for operation.			

Designation	Color	Meaning	State	Description
S	Green/ orange/ red	Sercos	Flashing orange (2 Hz)	Identification (bit 15 in device control (C-Dev)), used for address assignment and configuration errors.
			Orange ON	CP0
			Flashing orange/green	CP1: 250 ms green, 2750 ms orange
			Flashing orange/green	CP2: 250 ms green, 250 ms orange, 250 ms green, 2250 ms orange
			Flashing orange/green	CP3: 250 ms green, 250 ms orange, 250 ms green, 250 ms orange, 250 ms green, 1750 ms orange
			Green ON	CP4
			Green flashing	Loop back activated
			Flashing red/orange	User error
			Flashing red/green	MST loss
			Red ON	Communication error
			Flashing red (2 Hz)	Watchdog error
			OFF	NRT mode; no Sercos communication
			SD	Green/ orange/ red
Orange ON	Sub device is on the parameterization level (PL)			
Red ON	Error in the sub device (C1D)			
OFF	Sub device is not active.			
US	Green/ red	U _{Sensorik}	Green ON	Communications power/sensor voltage present
			OFF	Communications power/sensor voltage not present or too low.
			Red ON	Sensor voltage overload
UA	Green	U _{Aktorik}	ON	Actuator voltage present.
			OFF	Actuator voltage not present.

10.2 Input and output indicators

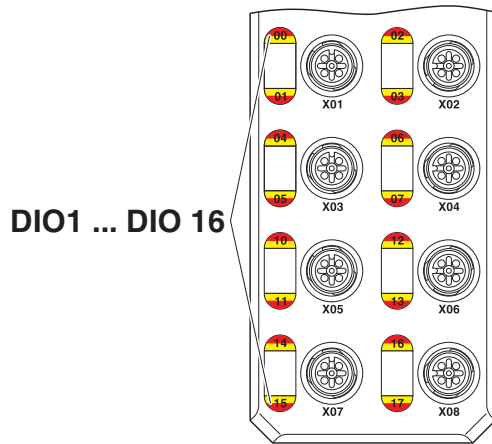

Figure 10 Input and output indicators

Designation	Color	Meaning	State	Description
00 ... 07, 10 ... 17	Yellow	Status of the inputs and outputs when used as an input	ON	Input is set.
			OFF	Input is not set.
00 ... 07, 10 ... 17	Yellow/red	Status of the inputs and outputs when used as an output	Yellow ON	Output is set.
			Red ON	Output is short circuited or overloaded.
			OFF	Output is not set.



The numbering of the LEDs is as follows: the first number specifies the byte, the second number specifies the bit.

11 Sercos realtime connections

The device supports a maximum of two realtime data connections (S-0-1050.0.x and S-1050.1.x), with a maximum of one consumer and one producer connection.

12 Sercos profiles, classes and function groups

The following Sercos profiles, classes, and function groups are implemented in the device.

12.1 Sercos device profile (GDP: Generic device profile)

- Basic device profile (GDP_Basic)
 - Diagnostics (FG_Diagnosis)
 - Administration (FG_Administration)
 - Device identification (FG_Identification)
- Revisions (GDP_Rev)
- Password (GDP_PWD)
- Diagnostic records (GDP_DiagT)
- Extended diagnostic records (GDP_DiagTAdv)
- Restart (GDP_RST)

12.2 Sercos communication model (SCP: Sercos communication profiles)

- Fixed configuration (SCP_FixCFG_02hex)
- Diagnostics (SCP_Diag)
- Non-realtime channel (SCP_NRTPC)
- Consumer connection monitoring (SCP_WDCon)
- Synchronous and isochronous producer and consumer data (SCP_Sync_02hex)
- Support for SCP_SIP and SCP_TFTP, TFTP is only active if it was activated via WBM.
- Cyclic data exchange (SCP_Cyc)

12.3 Sercos function model (FSP: Function specific profile IO)

- I/O function model (FSP_IO)

13 Sercos parameter

The following table lists all Sercos parameters (S and P parameters) with important features that have been implemented in the device.

IDN (Identification number)	Name	Default values	Unit
S-0-0014	Interface status	-	-
S-0-0015.0.0	Telegram type	-	-
S-0-0017	IDN list of all operation data	-	-
S-0-0021	IDN list of invalid operation data for CP2	-	-
S-0-0022	IDN list of invalid operation data for CP3	-	-
S-0-0025	IDN list of all procedure commands	-	-
S-0-0095	Diagnostic message	-	-
S-0-0099	Reset class 1 diagnostic (process command)	-	-
S-0-0127	CP3 transition check (process command)	-	-
S-0-0128	CP4 transition check (process command)	-	-
S-0-0267	Password	PW170875	-
S-0-0279	IDN-list of password protected data	-	-
S-0-0390	Diagnostic number	-	-
S-0-398	IDN list of configurable data as producer	-	-
S-0-399	IDN list of configurable data as consumer	-	-
S-0-1000	SCP type & version	-	-
S-0-1002	Communication cycle time (t_{Scyc})	-	μ s
S-0-1003	Allowed MST losses in CP3/CP4	10	-
S-0-1005	Minimum feedback processing time (t_5)	-	μ s
S-0-1006	ATO transmission starting time (t_1)	-	μ s
S-0-1007	Feedback acquisition capture point (t_4)	-	μ s
S-0-1008	Command value valid time (t_3)	-	μ s
S-0-1009	Device control (C-Dev) offset in MDT	-	-
S-0-1010	Length of MDTs	-	-
S-0-1011	Device status (S-Dev) offset in AT	-	-
S-0-1012	Length of ATs	-	-
S-0-1013	SVC offset in MDT	-	-
S-0-1014	SVC offset in AT	-	-
S-0-1015	Ring delay	-	μ s
S-0-1016	Slave delay	-	μ s
S-0-1017	NRT transmission time	-	μ s
S-0-1019	MAC address	00.A0.45.xx.xx.xx	-
S-0-1020	IP address	192.168.0.20	-
S-0-1020.0.1	Current IP address	192.168.0.20	-
S-0-1021	Subnet mask	255.255.255.0	-
S-0-1021.0.1	Current subnet mask	255.255.255.0	-
S-0-1022	Gateway address	192.168.0.1	-
S-0-1022.0.1	Current gateway address	192.168.0.1	-
S-0-1023	SYNC jitter	-	μ s
S-0-1024	SYNC delay measuring procedure command (process command)	-	-
S-0-1026	Version of communication hardware	-	-
S-0-1027.0.1	Requested MTU	-	-
S-0-1027.0.2	Effective MTU	-	-

IDN (Identification number)	Name	Default values	Unit
S-0-1028	Error counter MST-P/S	-	-
S-0-1031	Test pin assignment port 1 and port 2	-	-
S-0-1035	Error counter port1 and port2	-	-
S-0-1036	Inter frame gap	-	-
S-0-1037	Slave jitter	-	-
S-0-1040	Sercos address	1	-
S-0-1041	AT command value valid time (t9)	-	µs
S-0-1044	Device control	-	-
S-0-1045	Device status	-	-
S-0-1047	Maximum consumer activation time (t11)	-	µs
S-0-1048	Procedure command – Activate IP settings	-	-
S-0-1050.x.1	Connection setup	-	-
S-0-1050.x.2	Connection number	-	-
S-0-1050.x.3	Telegram assignment	-	-
S-0-1050.x.4	Max. length of connection	-	-
S-0-1050.x.5	Current length of connection	-	-
S-0-1050.x.6	Configuration list	-	-
S-0-1050.x.8	Connection control	-	-
S-0-1050.x.10	Producer cycle time	-	µs
S-0-1050.x.11	Allowed data losses	-	-
S-0-1050.x.12	Error counter data losses	-	-
S-0-1050.x.20	IDN allocation of real-time bit	-	-
S-0-1050.x.21	Bit allocation of real-time bit	-	-
S-0-1051	Image of connection setups	-	-
S-0-1300.0.1	Component name	Sercos block terminal	-
S-0-1300.0.2	Vendor name	Phoenix Contact	-
S-0-1300.0.3	Vendor code	200	-
S-0-1300.0.4	Device name	AXL E S3 DIO16 M12 6P	-
S-0-1300.0.5	Device ID	2701545	-
S-0-1300.0.7	Function revision	-	-
S-0-1300.0.8	Hardware revision	-	-
S-0-1300.0.9	Software revision	-	-
S-0-1300.0.10	Firmware loader revision	-	-
S-0-1300.0.11	Order number	2701545	-
S-0-1300.0.12	Serial number	xxxx...	-
S-0-1300.0.13	Manufacturing date parameter	YYYY-MM-DD T HH:MM:SS Z	-
S-0-1300.0.14	QA date	YYYY-MM-DD T HH:MM:SS Z (date and time of final manufacturing test)	-
S-0-1300.0.20	Operational hours	Operating hours counter	h
S-0-1300.0.21	Service date	YYYY-MM-DD T HH:MM:SS Z (date and time of a service)	-
S-0-1301	List of GDP classes & version	0101 _{hex}	-
S-0-1302.0.1	FSP type & version	00010001 _{hex}	-
S-0-1302.0.2	Function groups	S-0-1500.0.0 (IO bus coupler) S-0-1502.0.0 (Digital output) S-0-1503.0.0 (Digital input)	-
S-0-1302.0.3	Application type	-	-
S-0-1303.0.01*	Diagnosis trace configuration	-	-
S-0-1303.0.02	Diagnosis trace control	-	-

IDN (Identification number)	Name	Default values	Unit
S-0-1303.0.03	Diagnosis trace state	-	-
S-0-1303.0.10	Diagnosis trace buffer no1	-	-
S-0-1303.0.11	Diagnosis trace buffer no2	-	-
S-0-1303.0.12**	Diagnosis trace buffer no3	-	-
S-0-1305.0.1	Sercos current time	-	-
S-0-1350	Reboot device	-	-
S-0-1500	IO bus coupler	-	-
S-0-1500.0.1	IO control	-	-
S-0-1500.0.2	IO status	-	-
S-0-1500.0.3	List of module type codes	-	-
S-0-1500.0.5	Container output data	-	-
S-0-1500.0.9	Container input data	-	-
S-0-1500.0.19	Parameter channel receive	-	-
S-0-1500.0.20	Parameter channel transmit	-	-
S-0-1500.0.32	IO diagnostic message	-	-
S-0-1500.0.33	Current IO diagnostic message	-	-
S-0-1502	I/O function group digital output	-	-
S-0-1502.0.1	Name of IO FG	-	-
S-0-1502.0.2	Configuration of IO FG	-	-
S-0-1502.0.3	Channel quantity PDOOUT	-	-
S-0-1502.0.4	Channel width PDOOUT	-	-
S-0-1502.0.5	PDOOUT	-	-
S-0-1502.0.15	Channel quantity DIAGIN	-	-
S-0-1502.0.16	Channel width DIAGIN	-	-
S-0-1502.0.17	DIAGIN	-	-
S-0-1502.0.22	Fallback value output	-	-
S-0-1502.0.23	Min. delay time	-	-
S-0-1502.0.24	Max. delay time	-	-
S-0-1503	IO function group digital input	-	-
S-0-1503.0.1	Name of IO FG	-	-
S-0-1503.0.2	Configuration of IO FG	-	-
S-0-1503.0.7	Channel quantity PDIN	-	-
S-0-1503.0.8	Channel width PDIN	-	-
S-0-1503.0.9	PDIN	-	-
S-0-1503.0.15	Channel quantity DIAGIN	-	-
S-0-1503.0.16	Channel width DIAGIN	-	-
S-0-1503.0.17	DIAGIN	-	-
S-0-1503.0.23	Min. delay time	-	-
S-0-1503.0.24	Max. delay time	-	-

* The content of IDN S-0-1303.0.01 is limited to one IDN (S-0-1500.x.33 Current IO diagnostic message); this is why only one additional diagnostic trace is implemented (S-0-1303.0.12 Diagnostic trace buffer no3).

** IDN S-0-1303.0.12 diagnostic trace buffer no3 contains one IDN, which is configured in the S-0-1303.0.01 diagnostic trace configuration in such a way that the content of S-0-1303.0.12 is determined with the S-0-1500.x.33 Current IO Diagnostic Message.

14 Password (IDN S-0-00267)

In the default setting some parameters of the device are write-protected with a password. If you try to change password-protected parameters without lifting the write protection, error 7009_{hex} is output via the service channel (operation data is password write-protected).

The password can be changed and the write protection can be activated or deactivated via IDN S-0-0267. Passwords can only comprise UTF8 characters without spaces and are stored retentively.

The default password is PW170875.

The list of password-protected parameters can be found in IDN S-0-0279.

The following IDNs are password protected:

IDN	Description
S-0-1020	IP address
S-0-1021	Subnet mask
S-0-1022	Gateway address



If the password is read via the service channel, the device will send the password as a string with 3 "*" characters (UTF8 code 0x2A) if the write protection is activated or as a string with 3 "\$" characters (UTF8-Code 0x24) if the write protection is deactivated and not as plain text.

14.1 Change password

To change the password, the currently active password, the new password, and, for confirmation, the new password again must be sent to the device, each separated by a space. Changing the password automatically activates write protection for all password-protected parameters.

14.2 Activate write protection

There are three methods for activating password-protected write protection:

- Switch the power supply off and back on. Once the device is restarted, write protection is activated.
- Overwrite the password parameter with something other than the password.
- Change the existing password.

14.3 Deactivate write protection

The write protection is deactivated by overwriting the password parameter with the current password.

15 IP address assignment

The IP address is changed via the following IDNs:

IDN	Description
S-0-1020	IP address
S-0-1021	Subnet mask
S-0-1022	Gateway address
S-0-1048	Procedure Command - activation of the IP parameters

The IP address can be changed via the Sercos parameter S-0-1020.

The subnet mask can be changed via parameter S-0-1021 and the gateway address via parameter S-0-1022.

The IDN S-0-1048 is used to activate the IP address via Sercos.



All parameters are password-protected. For further information, please refer to the "Password" section.



The modified IP address parameters are not stored retentively on the device. In the case of a voltage reset, these parameters need to be re-transmitted.

16 Monitoring connection (connection setup, IDN S-0-1050.x.1)

The following connection monitoring mechanisms are supported (bit 0 and bit 1 of IDN S-0-1050.x.1):

- Producer cycle, synchronous operation (00_{bin})
- Asynchronous operation without watchdog (10_{bin})

17 Electronic rating plate (IDNs S-0-1300.x.y)

The electronic rating plate comprises the IDNs S-0-1300.x.y. See the table in the "Sercos parameter" section.

18 Substitute value behavior

The Axioline E Sercos devices support the substitute value behavior for outputs. If Sercos communication fails, all device outputs are set to the parameterized substitute values. The configuration and behavior of the substitute values can be defined via parameters S-0-1502.0.02 and S-0-1502.0.22.

The following substitute values are supported:

Substitute value	Description	Configuration
Reset all	All outputs are set to "0".	S-0-1502.0.02 "Configuration of IO FG" bit 6 = 0 (fallback) and S-0-1502.0.22 "Fallback value output" with the value "0" parameterized for all process data bits.
Set all	All outputs are set to "1".	S-0-1502.0.02 "Configuration of IO FG" bit 6 = 0 (fallback) and S-0-1502.0.22 "Fallback value output" parameterized with the value "1" for all process data bits.
Hold last value	All outputs keep the last value.	If S-0-1502.0.02 "Configuration of IO FG" bit 6 = 1 (freeze) is parameterized.
Switch replacement value	All outputs are set to an application-specific, parameterized value.	S-0-1502.0.02 "Configuration of IO FG" bit 6 = 0 (fallback) and S-0-1502.0.22 "Fallback value output" are parameterized with the application-specific value for all process data bits.

19 Diagnostics: I/O and channel errors

Sercos enables the Sercos device to store diagnostic information together with the error location and error type.

Diagnostic messages are enabled by default, but can be disabled via a parameter on startup.

The Sercos master is informed that diagnostic information that has been entered.

If at least one item of diagnostic information has been stored, this is indicated by the S and SD LEDs.

The following Sercos diagnostic messages are indicated by the Sercos slave:

- Overtemperature of the device
- Surge voltage of U_S
- Overload of U_S
- Unterspannung von U_S
- Short-circuit or overload of an output

I/O and channel errors are mapped in the following diagnostic IDNs according to Sercos specifications.

IDN	Description
S-0-0095	Diagnostic message
S-0-0390	Diagnostic number
S-1500.0.32	IO diagnostic message
S-1500.0.33	Current IO diagnostic message
S-1303.0.10	Diagnostic trace buffer no 1
S-1303.0.11	Diagnostic trace buffer no 2
S-1303.0.12	Diagnostic trace buffer no 3

20 Mapping the I/Os to Sercos

The device has just one Sercos module and therefore only has one structure instance 0.

The I/Os are assigned to the structure instances and IO function groups according to the Sercos IO profile.

The following function groups are defined:

Function group (FG_IO)	Name
S-0-1502	IO function group digital output
S-0-1503	IO function group digital input

The cyclical data of the Sercos device is mapped to the IDNs S-0-1502 and S-0-1503 according to FSP_IO.

The device supports the following IDNs as configurable data:

In a producer connection	In a consumer connection
S-0-1500.0.2	S-0-1500.0.1
S-0-1500.0.9	S-0-1500.0.1
FG_IO.x.9	FG_IO.x.5
FG_IO.x.13	FG_IO.x.11
S-0-0390	S-0-0390
This information is stored in:	
S-0-0187	S-0-0188

20.1 Assignment of the terminal points to the OUT process data (S-0-1502.0.05)

The I/O data is mapped as follows:

Output process data (S-0-1502.0.05)																
Byte	Byte 0								Byte 1							
Bit	7	6	5	4	3	2	1	0	7	6	5	4	3	2	1	0
OUT	07	06	05	04	03	02	01	00	17	16	15	14	13	12	11	10
Connection	X04		X03		X02		X01		X08		X07		X06		X05	
Pin	2	4	2	4	2	4	2	4	2	4	2	4	2	4	2	4
DO	8	7	6	5	4	3	2	1	16	15	14	13	12	11	10	9

Key:

- Bit: Process data assignment
- OUT: LED marking
- DO: Output of the device

20.2 Assignment of the terminal points to the IN process data (S-0-1503.0.09)

The I/O data is mapped as follows:

Input process data (S-0-1503.0.09)																
Byte	Byte 0								Byte 1							
Bit	7	6	5	4	3	2	1	0	7	6	5	4	3	2	1	0
IN	07	06	05	04	03	02	01	00	17	16	15	14	13	12	11	10
Connection	X04		X03		X02		X01		X08		X07		X06		X05	
Pin	2	4	2	4	2	4	2	4	2	4	2	4	2	4	2	4
DI	8	7	6	5	4	3	2	1	16	15	14	13	12	11	10	9

Key:

- Bit: Process data assignment
- IN: LED marking
- DI: Input of the device

20.3 Assignment of the DIAGIN process data (S-0-1502.0.17/S-0-1503.0.17)

4 bytes of DIAG IN data are available per function group.

Bit 31 ... bit 6	Bit 5	Bit 4	Bit 3	Bit 2	Bit 1	Bit 0
Reserved	Supply of the module electronics, sensors, and actuators (U_S)		Reserved		Outputs	
Reserved	Undervoltage	Overload	Reserved		Overload	Short-circuit



Not all diagnostic data are mapped in the process data, see chapter "Diagnostics: I/O and channel errors".

20.4 Configuration of digital inputs and outputs

A channel, whether an input or an output, is configured by using the IN or OUT process data according to the channel function. Parameterization is not necessary.



If the channel is used as an output, the status of the channel is also mapped to the IN process data. This can be useful, e.g., for diagnostic purposes. If the channel is used as an input, the channel cannot simultaneously be used as an output.

21 Delivery state/default settings

By default upon delivery, the following functions and features are available:

IP settings

Sercos address:	1
IP address:	192.168.0.20
Subnet mask:	255.255.255.0
Gateway address:	192.168.0.1

Firmware update

Firmware update on next re-start:	deactivated
TFTP server IP address	192.168.210.211
Firmware file name:	FIRMWARE.NXF

Web-based Management (WBM)

User name:	admin
Password:	private

22 Restoring the default settings

The following options are available for restoring the default settings:

Rotary encoding switch

Switch position 0F, for further information see section "Configuration via rotary coding switch".

Web-based Management (WBM)

Navigate to "Manage > Default settings" and follow the instructions.

23 Firmware started

Once you have connected the power, the firmware is started.

After completion of the firmware boot process, the RDY LED lights up green.

24 Firmware update

In order to update the firmware of the device, the device must be provided with a firmware container via a TFTP server or it must be loaded onto the device via FTP. Any FTP client or TFTP server can be used for this. The update must always be initiated by the web-based management. When carrying out the firmware update, the RDY LED flashes yellow.

25 WBM - Web-based management

The device has a web server, which generates the required pages for web-based management and, depending on the requirements of the user, sends them to a standard web browser. Web-based management can be used to access static information (e.g., technical data, MAC address) or dynamic information (e.g., IP address, status information).

Calling web-based management

The device web server can be addressed using the IP address if configured accordingly. The homepage (web page) of the device is accessed by entering the URL "http://ip-address".

Example: http://192.168.0.20

The default user name is "admin", the default password is "private".



If you cannot access the WBM pages, check the connection settings in your browser and deactivate the proxy, if set.

26 Device description file (SDDml)

A configuration file (SDDml) is provided for parameterization in an engineering system.

Parameterization can then be carried out by the Sercos master.

If several versions of the configuration file are available, make sure that you are working with the file version that corresponds to the firmware/hardware version used.



For the latest device description files, visit phoenixcontact.net/products.

Данный компонент на территории Российской Федерации

Вы можете приобрести в компании MosChip.

Для оперативного оформления запроса Вам необходимо перейти по данной ссылке:

<http://moschip.ru/get-element>

Вы можете разместить у нас заказ для любого Вашего проекта, будь то серийное производство или разработка единичного прибора.

В нашем ассортименте представлены ведущие мировые производители активных и пассивных электронных компонентов.

Нашей специализацией является поставка электронной компонентной базы двойного назначения, продукции таких производителей как XILINX, Intel (ex.ALTERA), Vicor, Microchip, Texas Instruments, Analog Devices, Mini-Circuits, Amphenol, Glenair.

Сотрудничество с глобальными дистрибьюторами электронных компонентов, предоставляет возможность заказывать и получать с международных складов практически любой перечень компонентов в оптимальные для Вас сроки.

На всех этапах разработки и производства наши партнеры могут получить квалифицированную поддержку опытных инженеров.

Система менеджмента качества компании отвечает требованиям в соответствии с ГОСТ Р ИСО 9001, ГОСТ РВ 0015-002 и ЭС РД 009

Офис по работе с юридическими лицами:

105318, г.Москва, ул.Щербаковская д.3, офис 1107, 1118, ДЦ «Щербаковский»

Телефон: +7 495 668-12-70 (многоканальный)

Факс: +7 495 668-12-70 (доб.304)

E-mail: info@moschip.ru

Skype отдела продаж:

moschip.ru

moschip.ru_4

moschip.ru_6

moschip.ru_9