

# SPC, Encapsulated Double Metallized, Size 2824 – 6560, 100 – 630 VDC

## Overview

Film capacitor for surface mounting with a double-sided metallized film as the electrode and a plain PPS as the dielectric. A rugged-box encapsulation in a self-extinguishing material meets the requirements of UL 94 V-0. SPC capacitors meet the standards according to IEC 60384-20.

## Applications

The SPC Series is designed for high frequency coupling and decoupling as well as general high speed applications requiring high dV/dt such as pulse operation in switched-mode power supply (SMPS). Not suitable for across-the-line application (see suppressor capacitors).

## Benefits

- Rated voltage: 100 – 630 VDC
- Rated voltage: 63 – 350 VAC
- Capacitance range: 0.00047 – 0.68  $\mu$ F
- EIA Size: 2824 – 6560
- Capacitance tolerance:  $\pm$ 2%,  $\pm$ 2.5%,  $\pm$ 5%,  $\pm$ 10%
- Climatic category: 55/125/56
- RoHS Compliant and lead-free terminations
- Operating temperature range of  $-55^{\circ}\text{C}$  to  $+125^{\circ}\text{C}$

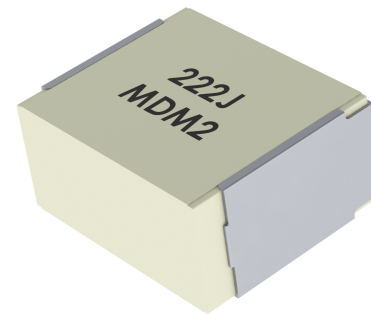

## Customer Part Number

SPC	7.3	471	K	100	K33	TR12
Series	Chip Length (mm)	Capacitance Code (pF)	Capacitance Tolerance	Rated Voltage (VDC)	Size Code	Packaging
Double Metallized PPS	7.3 10.2 12.7 16.5	First two digits represent significant figures. The third digit specifies number of zeros.	G = $\pm$ 2% H = $\pm$ 2.5% J = $\pm$ 5% K = $\pm$ 10%	100 250 400 630	See Dimension Table	See Ordering Options Table

## KEMET Internal Part Number

F	127	S	L	471	K	100	V
Capacitor Class	Series	Chip Size	Size Code	Capacitance Code (pF)	Capacitance Tolerance	Rated Voltage (VDC)	Packaging
F = Film	Double Metallized PPS	S = 2824 W = 4036 Y = 5045 Z = 6560	See Dimension Table	First two digits represent significant figures. The third digit specifies number of zeros.	G = $\pm$ 2% R = $\pm$ 2.5% J = $\pm$ 5% K = $\pm$ 10%	100 250 400 630	See Ordering Options Table

## Ordering Options Table

Chip Size (EIA)	Packaging Type	KEMET Packaging Code	Legacy Packaging Code
2824	<b>Standard Packaging Options</b>		
	Tape & Reel (Standard Reel)	V	TR12
	Bulk (Bag)	A	BULK
4036	<b>Standard Packaging Options</b>		
	Tape & Reel (Horizontal Orientation Standard Reel)	V	TR16
	Bulk (Bag)	A	BULK
	<b>Other Packaging Options</b>		
	Tape & Reel (Vertical Orientation Standard Reel)	Y	TV24
5045	<b>Standard Packaging Options</b>		
	Tape & Reel (Standard Reel)	V	TR24
	Bulk (Bag)	A	BULK
	<b>Other Packaging Options</b>		
	Tape & Reel (Vertical Orientation Standard Reel)	Y	TV24
6560	<b>Standard Packaging Options</b>		
	Tape & Reel (Standard Reel)	V	TR24
	Bulk (Bag)	A	BULK
	<b>Other Packaging Options</b>		
	Tape & Reel (Vertical Orientation Standard Reel)	Y	TV44

## Dimensions – Millimeters

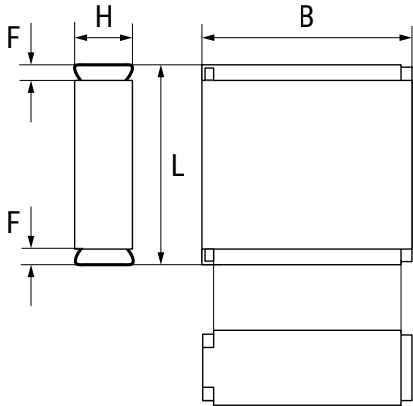

KEMET Size Code	Legacy Size Code	Chip Size (EIA)	B		H		L		F	
			Nominal	Tolerance	Nominal	Tolerance	Nominal	Tolerance	Nominal	Tolerance
SL	K33	2824	6.0	±0.2	3.0	±0.2	7.3	±0.2	0.5	Nominal
SP	K35	2824	6.0	±0.2	3.5	±0.2	7.3	±0.2	0.5	Nominal
ST	K37	2824	6.0	±0.2	4.5	±0.2	7.3	±0.2	0.5	Nominal
WP	A31	4036	9.1	±0.2	5.5	±0.2	10.2	±0.2	0.5	Nominal
YR	B31	5045	11.5	±0.2	6.5	±0.2	12.7	±0.2	0.5	Nominal
ZS	C31	6560	15.0	±0.2	7.0	±0.2	16.5	±0.2	0.5	Nominal

## Environmental Compliance

All KEMET surface mount capacitors are RoHS Compliant.



## Performance Characteristics

Rated Voltage (VDC)	100	250	400	630
Rated Voltage (VAC)	63	160	250	350
Capacitance Range (µF)	0.00047 – 0.68	0.00047 – 0.33	0.00047 – 0.15	0.00047 – 0.10
Chip Size (EIA)	2824 – 6560			
Capacitance Tolerance	±2%, ±2.5%, ±5%, ±10%			
Category Temperature Range	-55°C to +125°C			
Rated Temperature	+100°C			
Voltage Derating	The rated voltage should be decreased with 1.25%/°C from +100°C to +125°C and 1.5%/°C from +125°C to 175°C			
Climatic Category	55/125/56			
Test Voltage	1.6 x V <sub>R</sub> , 60 seconds			
Insulation Resistance	Measured at +20°C According to IEC 60384-19			
	Between Terminals			
		C ≤ 0.33 µF	C > 0.33 µF	
	V <sub>R</sub> ≤ 100	15,000 MΩ	5,000 MΩ · µF	
V <sub>R</sub> > 100	30,000 MΩ	10,000 MΩ · µF		
Dissipation Factor	Maximum Values at +23°C			
		C ≤ 0.1 µF	0.1 < C < 0.68 µF	
	1 kHz	0.10%	0.10%	
	10 kHz	0.15%	0.15%	
100 kHz	0.20%	0.40%		
Pulse Rise Time	The capacitors can withstand an unlimited number of pulses with a dV/dt, according to Table 1. For voltages (V) lower than the rated voltage (V <sub>R</sub> ), the specified dV/dt can be multiplied by V <sub>R</sub> /V.			

### Capacitance vs. Temperature

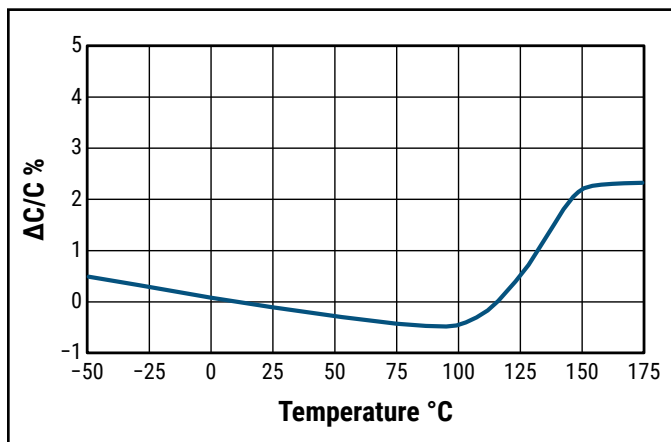

### Dissipation Factor vs. Temperature

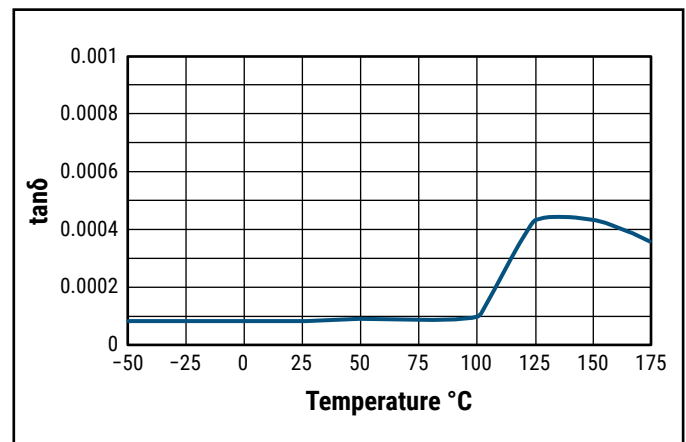

**Table 1 – Ratings & Part Number Reference**

VDC	VAC	Capacitance Value (µF)	Size Code (New/Legacy)	Dimensions in mm			Chip Size	dV/dt (V/µs)	New KEMET Part Number	Legacy Part Number
				B	H	L				
100	63	0.00047	SL/K33	6.0	3.0	7.3	2824	800	F127SL471(1)100(2)	SPC7.3471(1)100K33(2)
100	63	0.00068	SL/K33	6.0	3.0	7.3	2824	800	F127SL681(1)100(2)	SPC7.3681(1)100K33(2)
100	63	0.0010	SL/K33	6.0	3.0	7.3	2824	800	F127SL102(1)100(2)	SPC7.3102(1)100K33(2)
100	63	0.0015	SL/K33	6.0	3.0	7.3	2824	800	F127SL152(1)100(2)	SPC7.3152(1)100K33(2)
100	63	0.0022	SL/K33	6.0	3.0	7.3	2824	800	F127SL222(1)100(2)	SPC7.3222(1)100K33(2)
100	63	0.0033	SL/K33	6.0	3.0	7.3	2824	800	F127SL332(1)100(2)	SPC7.3332(1)100K33(2)
100	63	0.0047	SL/K33	6.0	3.0	7.3	2824	800	F127SL472(1)100(2)	SPC7.3472(1)100K33(2)
100	63	0.0068	SL/K33	6.0	3.0	7.3	2824	800	F127SL682(1)100(2)	SPC7.3682(1)100K33(2)
100	63	0.010	SL/K33	6.0	3.0	7.3	2824	800	F127SL103(1)100(2)	SPC7.3103(1)100K33(2)
100	63	0.015	SL/K33	6.0	3.0	7.3	2824	800	F127SL153(1)100(2)	SPC7.3153(1)100K33(2)
100	63	0.022	SP/K35	6.0	3.5	7.3	2824	800	F127SP223(1)100(2)	SPC7.3223(1)100K35(2)
100	63	0.033	ST/K37	6.0	4.5	7.3	2824	800	F127ST333(1)100(2)	SPC7.3333(1)100K37(2)
100	63	0.0068	WP/A31	9.1	5.5	10.2	4036	600	F127WP682(1)100(2)	SPC10.2682(1)100A31(2)
100	63	0.010	WP/A31	9.1	5.5	10.2	4036	600	F127WP103(1)100(2)	SPC10.2103(1)100A31(2)
100	63	0.015	WP/A31	9.1	5.5	10.2	4036	600	F127WP153(1)100(2)	SPC10.2153(1)100A31(2)
100	63	0.022	WP/A31	9.1	5.5	10.2	4036	600	F127WP223(1)100(2)	SPC10.2223(1)100A31(2)
100	63	0.033	WP/A31	9.1	5.5	10.2	4036	600	F127WP333(1)100(2)	SPC10.2333(1)100A31(2)
100	63	0.047	WP/A31	9.1	5.5	10.2	4036	600	F127WP473(1)100(2)	SPC10.2473(1)100A31(2)
100	63	0.068	WP/A31	9.1	5.5	10.2	4036	600	F127WP683(1)100(2)	SPC10.2683(1)100A31(2)
100	63	0.10	WP/A31	9.1	5.5	10.2	4036	600	F127WP104(1)100(2)	SPC10.2104(1)100A31(2)
100	63	0.15	YR/B31	11.5	6.5	12.7	5045	400	F127YR154(1)100(2)	SPC12.7154(1)100B31(2)
100	63	0.22	YR/B31	11.5	6.5	12.7	5045	400	F127YR224(1)100(2)	SPC12.7224(1)100B31(2)
100	63	0.33	ZS/C31	15.0	7.0	16.5	6560	150	F127ZS334(1)100(2)	SPC16.5334(1)100C31(2)
100	63	0.47	ZS/C31	15.0	7.0	16.5	6560	150	F127ZS474(1)100(2)	SPC16.5474(1)100C31(2)
100	63	0.68	ZS/C31	15.0	7.0	16.5	6560	150	F127ZS684(1)100(2)	SPC16.5684(1)100C31(2)
250	160	0.00047	SL/K33	6.0	3.0	7.3	2824	1200	F127SL471(1)250(2)	SPC7.3471(1)250K33(2)
250	160	0.00068	SL/K33	6.0	3.0	7.3	2824	1200	F127SL681(1)250(2)	SPC7.3681(1)250K33(2)
250	160	0.0010	SL/K33	6.0	3.0	7.3	2824	1200	F127SL102(1)250(2)	SPC7.3102(1)250K33(2)
250	160	0.0015	SL/K33	6.0	3.0	7.3	2824	1200	F127SL152(1)250(2)	SPC7.3152(1)250K33(2)
250	160	0.0022	SL/K33	6.0	3.0	7.3	2824	1200	F127SL222(1)250(2)	SPC7.3222(1)250K33(2)
250	160	0.0033	SL/K33	6.0	3.0	7.3	2824	1200	F127SL332(1)250(2)	SPC7.3332(1)250K33(2)
250	160	0.0047	SL/K33	6.0	3.0	7.3	2824	1200	F127SL472(1)250(2)	SPC7.3472(1)250K33(2)
250	160	0.0068	SL/K33	6.0	3.0	7.3	2824	1200	F127SL682(1)250(2)	SPC7.3682(1)250K33(2)
250	160	0.010	SP/K35	6.0	3.5	7.3	2824	1200	F127SP103(1)250(2)	SPC7.3103(1)250K35(2)
250	160	0.015	ST/K37	6.0	4.5	7.3	2824	1200	F127ST153(1)250(2)	SPC7.3153(1)250K37(2)
250	160	0.0068	WP/A31	9.1	5.5	10.2	4036	1000	F127WP682(1)250(2)	SPC10.2682(1)250A31(2)
250	160	0.010	WP/A31	9.1	5.5	10.2	4036	1000	F127WP103(1)250(2)	SPC10.2103(1)250A31(2)
250	160	0.015	WP/A31	9.1	5.5	10.2	4036	1000	F127WP153(1)250(2)	SPC10.2153(1)250A31(2)
250	160	0.022	WP/A31	9.1	5.5	10.2	4036	1000	F127WP223(1)250(2)	SPC10.2223(1)250A31(2)
250	160	0.033	WP/A31	9.1	5.5	10.2	4036	1000	F127WP333(1)250(2)	SPC10.2333(1)250A31(2)
VDC	VAC	Capacitance Value (µF)	Size Code (New/Legacy)	B (mm)	H (mm)	L (mm)	Chip Size	dV/dt (V/µs)	New KEMET Part Number	Legacy Part Number

- (1) G = ±2%, R = ±2.5% (Legacy code = H), J = ±5%, K = ±10%.  
 (2) Insert ordering code for lead type and packaging. See Ordering Options Table for available options.

**Table 1 – Ratings & Part Number Reference cont.**

VDC	VAC	Capacitance Value (µF)	Size Code (New/Legacy)	Dimensions in mm			Chip Size	dV/dt (V/µs)	New KEMET Part Number	Legacy Part Number
				B	H	L				
250	160	0.047	WP/A31	9.1	5.5	10.2	4036	1000	F127WP473(1)250(2)	SPC10.2473(1)250A31(2)
250	160	0.068	YR/B31	11.5	6.5	12.7	5045	700	F127YR683(1)250(2)	SPC12.7683(1)250B31(2)
250	160	0.10	YR/B31	11.5	6.5	12.7	5045	700	F127YR104(1)250(2)	SPC12.7104(1)250B31(2)
250	160	0.15	ZS/C31	15.0	7.0	16.5	6560	350	F127ZS154(1)250(2)	SPC16.5154(1)250C31(2)
250	160	0.22	ZS/C31	15.0	7.0	16.5	6560	350	F127ZS224(1)250(2)	SPC16.5224(1)250C31(2)
250	160	0.33	ZS/C31	15.0	7.0	16.5	6560	350	F127ZS334(1)250(2)	SPC16.5334(1)250C31(2)
400	250	0.00047	SL/K33	6.0	3.0	7.3	2824	1600	F127SL471(1)400(2)	SPC7.3471(1)400K33(2)
400	250	0.00068	SL/K33	6.0	3.0	7.3	2824	1600	F127SL681(1)400(2)	SPC7.3681(1)400K33(2)
400	250	0.0010	SL/K33	6.0	3.0	7.3	2824	1600	F127SL102(1)400(2)	SPC7.3102(1)400K33(2)
400	250	0.0015	SL/K33	6.0	3.0	7.3	2824	1600	F127SL152(1)400(2)	SPC7.3152(1)400K33(2)
400	250	0.0022	SL/K33	6.0	3.0	7.3	2824	1600	F127SL222(1)400(2)	SPC7.3222(1)400K33(2)
400	250	0.0033	SL/K33	6.0	3.0	7.3	2824	1600	F127SL332(1)400(2)	SPC7.3332(1)400K33(2)
400	250	0.0047	SP/K35	6.0	3.5	7.3	2824	1600	F127SP472(1)400(2)	SPC7.3472(1)400K35(2)
400	250	0.0068	ST/K37	6.0	4.5	7.3	2824	1600	F127ST682(1)400(2)	SPC7.3682(1)400K37(2)
400	250	0.0068	WP/A31	9.1	5.5	10.2	4036	1300	F127WP682(1)400(2)	SPC10.2682(1)400A31(2)
400	250	0.010	WP/A31	9.1	5.5	10.2	4036	1300	F127WP103(1)400(2)	SPC10.2103(1)400A31(2)
400	250	0.015	WP/A31	9.1	5.5	10.2	4036	1300	F127WP153(1)400(2)	SPC10.2153(1)400A31(2)
400	250	0.022	WP/A31	9.1	5.5	10.2	4036	1300	F127WP223(1)400(2)	SPC10.2223(1)400A31(2)
400	250	0.033	YR/B31	11.5	6.5	12.7	5045	900	F127YR333(1)400(2)	SPC12.7333(1)400B31(2)
400	250	0.047	YR/B31	11.5	6.5	12.7	5045	900	F127YR473(1)400(2)	SPC12.7473(1)400B31(2)
400	250	0.068	ZS/C31	15.0	7.0	16.5	6560	450	F127ZS683(1)400(2)	SPC16.5683(1)400C31(2)
400	250	0.10	ZS/C31	15.0	7.0	16.5	6560	450	F127ZS104(1)400(2)	SPC16.5104(1)400C31(2)
400	250	0.15	ZS/C31	15.0	7.0	16.5	6560	450	F127ZS154(1)400(2)	SPC16.5154(1)400C31(2)
630	350	0.00047	SL/K33	6.0	3.0	7.3	2824	2000	F127SL471(1)630(2)	SPC7.3471(1)630K33(2)
630	350	0.00068	SL/K33	6.0	3.0	7.3	2824	2000	F127SL681(1)630(2)	SPC7.3681(1)630K33(2)
630	350	0.0010	SL/K33	6.0	3.0	7.3	2824	2000	F127SL102(1)630(2)	SPC7.3102(1)630K33(2)
630	350	0.0015	SL/K33	6.0	3.0	7.3	2824	2000	F127SL152(1)630(2)	SPC7.3152(1)630K33(2)
630	350	0.0022	SL/K33	6.0	3.0	7.3	2824	2000	F127SL222(1)630(2)	SPC7.3222(1)630K33(2)
630	350	0.0033	SP/K35	6.0	3.5	7.3	2824	2000	F127SP332(1)630(2)	SPC7.3332(1)630K35(2)
630	350	0.0047	ST/K37	6.0	4.5	7.3	2824	2000	F127ST472(1)630(2)	SPC7.3472(1)630K37(2)
630	350	0.0068	WP/A31	9.1	5.5	10.2	4036	1600	F127WP682(1)630(2)	SPC10.2682(1)630A31(2)
630	350	0.010	WP/A31	9.1	5.5	10.2	4036	1600	F127WP103(1)630(2)	SPC10.2103(1)630A31(2)
630	350	0.015	WP/A31	9.1	5.5	10.2	4036	1600	F127WP153(1)630(2)	SPC10.2153(1)630A31(2)
630	350	0.022	YR/B31	11.5	6.5	12.7	5045	1100	F127YR223(1)630(2)	SPC12.7223(1)630B31(2)
630	350	0.033	YR/B31	11.5	6.5	12.7	5045	1100	F127YR333(1)630(2)	SPC12.7333(1)630B31(2)
630	350	0.047	ZS/C31	15.0	7.0	16.5	6560	550	F127ZS473(1)630(2)	SPC16.5473(1)630C31(2)
630	350	0.068	ZS/C31	15.0	7.0	16.5	6560	550	F127ZS683(1)630(2)	SPC16.5683(1)630C31(2)
630	350	0.10	ZS/C31	15.0	7.0	16.5	6560	550	F127ZS104(1)630(2)	SPC16.5104(1)630C31(2)
VDC	VAC	Capacitance Value (µF)	Size Code (New/Legacy)	B (mm)	H (mm)	L (mm)	Chip Size	dV/dt (V/µs)	New KEMET Part Number	Legacy Part Number

(1) G = ±2%, R = ±2.5% (Legacy code = H), J = ±5%, K = ±10%.  
 (2) Insert ordering code for lead type and packaging. See Ordering Options Table for available options.

## Soldering Process

**Reflow soldering temperature is measured on the top surface of the component:** Preheating temperature should be less than 170°C. The time above 217°C should be less than 50 seconds. The peak temperature must not exceed 260°C.

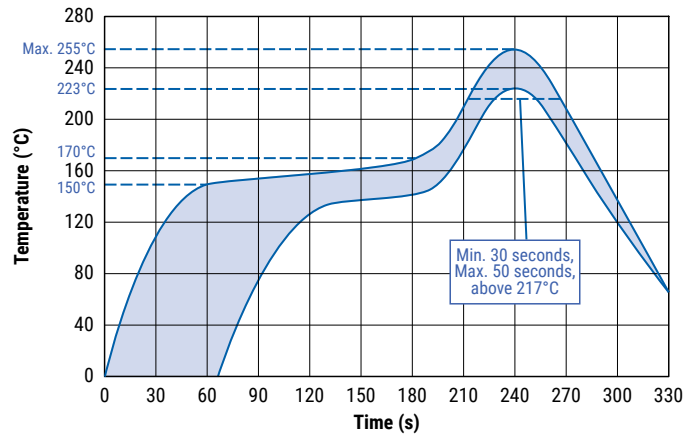

## Construction

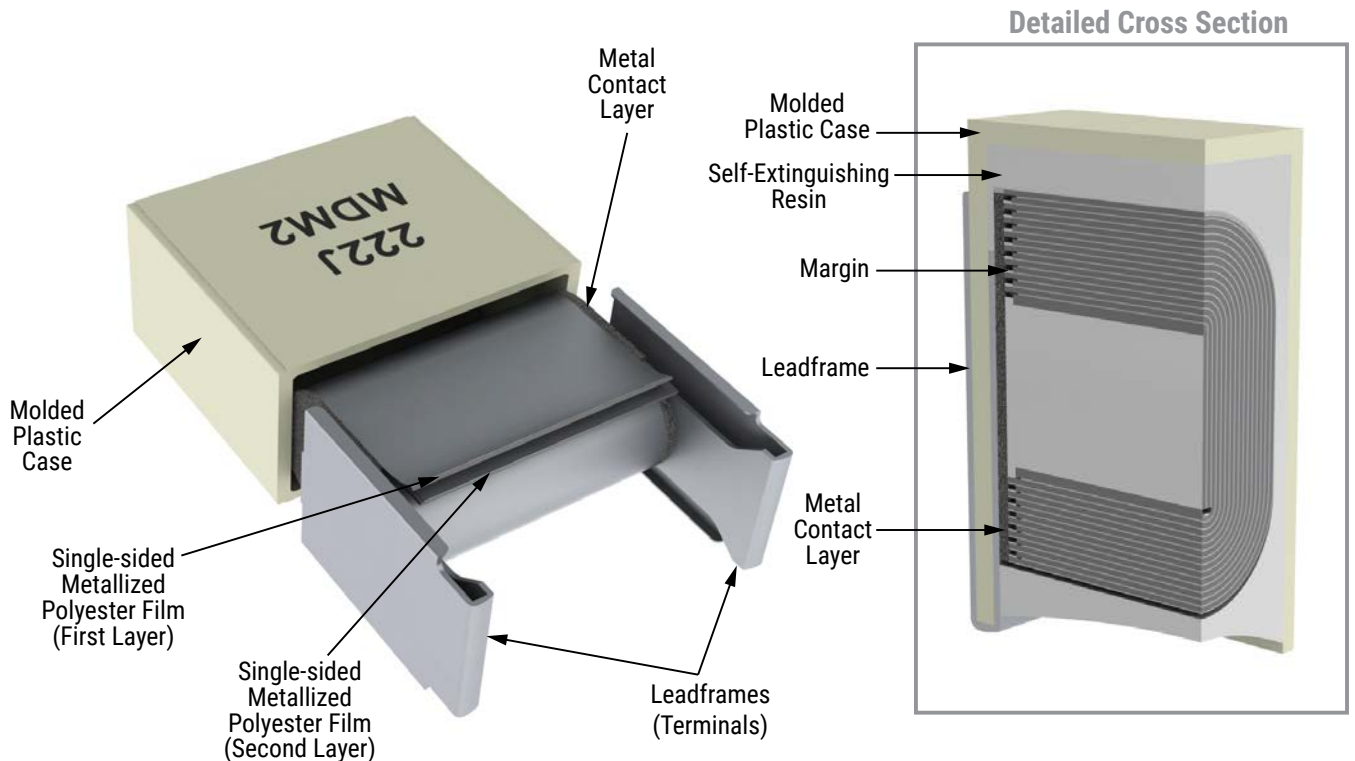

## Marking

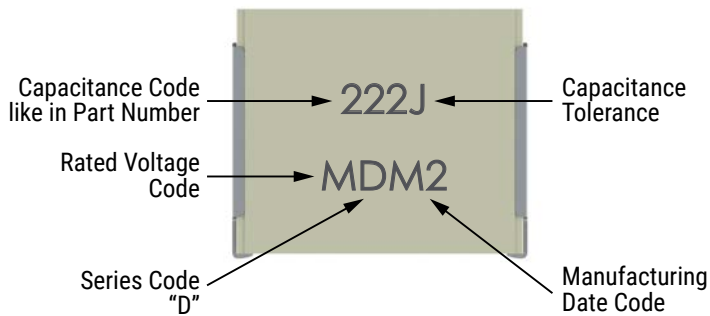

Rated Voltage	Code
100 VDC	D
250 VDC	H
400 VDC	K
630 VDC	M

Manufacturing Date Code (IEC 60062)			
Year	Code	Month	Code
2010	A	January	1
2011	B	February	2
2012	C	March	3
2013	D	April	4
2014	E	May	5
2015	F	June	6
2016	H	July	7
2017	J	August	8
2018	K	September	9
2019	L	October	0
2020	M	November	N
2021	N	December	D
2022	P		
2023	R		
2024	S		
2025	T		
2026	U		
2027	V		
2028	W		
2029	X		
2030	A		

## Flux & Cleaning

KEMET recommends using a no-clean flux with a halogen content lower than 0.1%. To clean the PCB assembly KEMET recommends to use a suitable solvent like Isopropyl alcohol, deionized water, or neutral pH detergents. Aggressive solvents shall not be used. For any different cleaning solvent used please contact KEMET Technical Services to analyze the potential impact on KEMET products.



## Storage and Moisture Recommendations

KEMET SMD Film Capacitors are supplied in a MBB (Moisture Barrier Bag) Class 1. We can guarantee a 24 month shelf life (temperature  $\leq 40^{\circ}\text{C}$ /relative humidity  $\leq 90\%$ ). After the MBB has been opened, components may stay in areas with controlled temperature and humidity (temperature  $\leq 30^{\circ}\text{C}$ /relative humidity  $\leq 60\%$ ) for 696 hours [MSL 2a]. For longer periods of time and/or higher temperature and/or higher relative humidity values, it is absolutely necessary to protect the components against humidity. If the reel inside the MBB is partially used, KEMET recommends to re-use the same MBB or to avoid areas without controlled temperature and humidity (see above). If the above conditions are not respected, components require a baking (minimum time: 48 hours at  $55 \pm 5^{\circ}\text{C}$ ) before the reflow.

## Packaging Quantities

Chip Size (EIA)	Base (mm)	Height (mm)	Length (mm)	Bulk	Reel Horizontal Orientation	Reel Vertical Orientation
2824	6.0	3.0	7.3	2,000	2,500	
2824	6.0	3.5	7.3	2,000	2,300	
2824	6.0	4.5	7.3	1,000	1,700	
4036	9.1	5.5	10.2	1,000	800	500
5045	11.5	6.5	12.7	1,000	600	400
6560	15.0	7.0	16.5	800	500	200

## Landing

Mounting	Chip Size	Dimensions in mm		
		A	B	X
Horizontal	2220	5.1	1.5	3.0
	2824	6.1	1.5	3.8
	4036	9.1	2.0	5.5
	5045	11.6	2.5	7.0
	6560	15.0	3.0	9.0
Vertical	4022	5.6	2.0	5.5
	5026	6.6	2.5	7.0
	6528	7.1	3.0	9.0

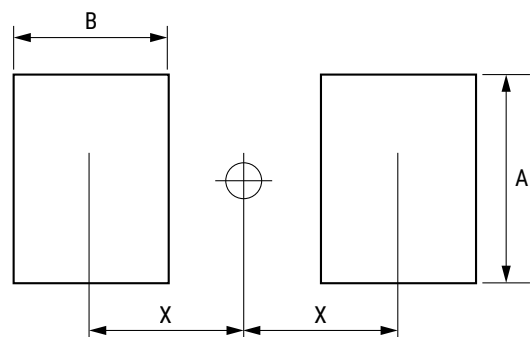

## Carrier Taping & Packaging (IEC 60286-2)

### Horizontal Taping Orientation

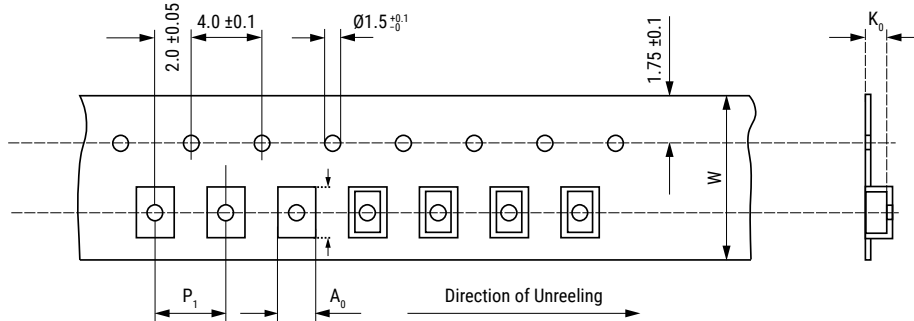

Chip Size (EIA) Horizontal Mounting	Dimensions in mm			Taping Specification							
	B	H	L	W	P <sub>1</sub>	A <sub>0</sub>	B <sub>0</sub>	K <sub>0</sub>	D	W <sub>1</sub>	W <sub>2</sub>
	Nominal	Nominal	Nominal	-0/+0.3	±0.1	Nominal	Nominal	Nominal	±2.0	-0/+2	Maximum
2220	5.0	3.0	5.7	12.0	8.0	5.5	6.0	3.3	330	12.4	22.0
2220	5.0	4.0	5.7	12.0	8.0	5.5	6.0	4.3	330	12.4	22.0
2824	6.0	3.0	7.3	12.0	8.0	6.5	7.5	3.3	330	12.4	22.0
2824	6.0	3.5	7.3	12.0	8.0	6.5	7.5	3.8	330	12.4	22.0
2824	6.0	4.5	7.3	16.0	8.0	6.6	7.9	5.5	330	16.0	20.0
4036	9.1	5.5	10.2	16.0	16.0	9.5	10.5	5.8	330	16.4	22.0
5045	11.5	6.5	12.7	24.0	16.0	11.9	13.1	6.8	330	24.4	30.0
6560	15.0	7.0	16.5	24.0	20.0	15.4	16.8	7.3	330	24.4	30.0

## Carrier Taping & Packaging (IEC 60286-2) cont.

### Vertical Taping Orientation

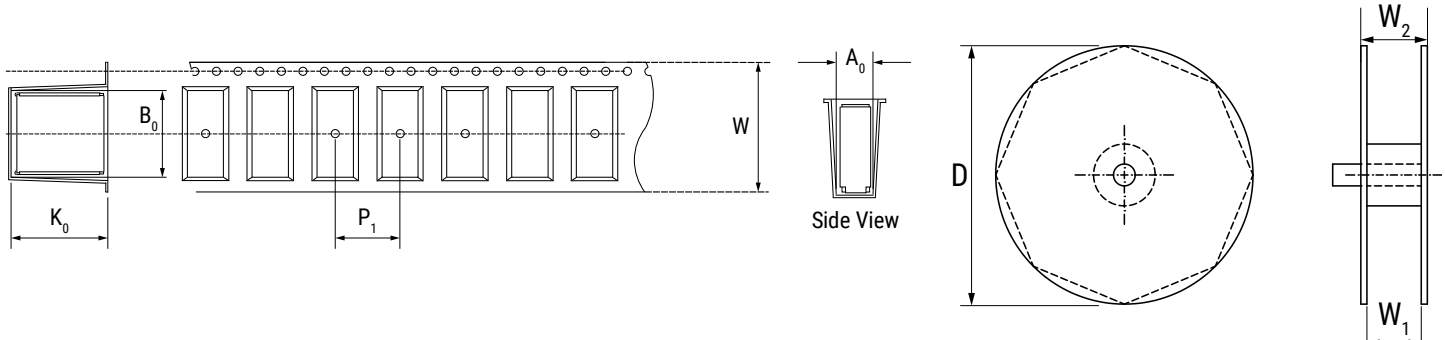

Size Code Vertical Mounting	Dimensions in mm			Taping Specification							
	B	H	L	W	$P_1$	$A_0$	$B_0$	$K_0$	D	$W_1$	$W_2$
	Nominal	Nominal	Nominal	-0/+0.3	$\pm 0.1$	Nominal	Nominal	Nominal	$\pm 2.0$	-0/+2	Maximum
4022	5.5	9.1	10.2	24.0	16.0	6.0	10.5	9.3	330	24.4	30.0
5026	6.5	11.5	12.7	24.0	16.0	6.9	13.1	11.8	330	24.4	30.0
6528	7.0	15.0	16.5	44.0	20.0	7.5	17.0	15.3	330	44.5	49.5

**Note: Chip dimensions B and H correspond to dimensions H and B in the horizontal mounting table.**

## KEMET Electronics Corporation Sales Offices

For a complete list of our global sales offices, please visit [www.kemet.com/sales](http://www.kemet.com/sales).

---

### Disclaimer

All product specifications, statements, information and data (collectively, the "Information") in this datasheet are subject to change. The customer is responsible for checking and verifying the extent to which the Information contained in this publication is applicable to an order at the time the order is placed. All Information given herein is believed to be accurate and reliable, but it is presented without guarantee, warranty, or responsibility of any kind, expressed or implied.

Statements of suitability for certain applications are based on KEMET Electronics Corporation's ("KEMET") knowledge of typical operating conditions for such applications, but are not intended to constitute – and KEMET specifically disclaims – any warranty concerning suitability for a specific customer application or use. The Information is intended for use only by customers who have the requisite experience and capability to determine the correct products for their application. Any technical advice inferred from this Information or otherwise provided by KEMET with reference to the use of KEMET's products is given gratis, and KEMET assumes no obligation or liability for the advice given or results obtained.

Although KEMET designs and manufactures its products to the most stringent quality and safety standards, given the current state of the art, isolated component failures may still occur. Accordingly, customer applications which require a high degree of reliability or safety should employ suitable designs or other safeguards (such as installation of protective circuitry or redundancies) in order to ensure that the failure of an electrical component does not result in a risk of personal injury or property damage.

Although all product-related warnings, cautions and notes must be observed, the customer should not assume that all safety measures are indicated or that other measures may not be required.

*KEMET is a registered trademark of KEMET Electronics Corporation.*

## Данный компонент на территории Российской Федерации

### Вы можете приобрести в компании MosChip.

Для оперативного оформления запроса Вам необходимо перейти по данной ссылке:

<http://moschip.ru/get-element>

Вы можете разместить у нас заказ для любого Вашего проекта, будь то серийное производство или разработка единичного прибора.

В нашем ассортименте представлены ведущие мировые производители активных и пассивных электронных компонентов.

Нашей специализацией является поставка электронной компонентной базы двойного назначения, продукции таких производителей как XILINX, Intel (ex.ALTERA), Vicor, Microchip, Texas Instruments, Analog Devices, Mini-Circuits, Amphenol, Glenair.

Сотрудничество с глобальными дистрибьюторами электронных компонентов, предоставляет возможность заказывать и получать с международных складов практически любой перечень компонентов в оптимальные для Вас сроки.

На всех этапах разработки и производства наши партнеры могут получить квалифицированную поддержку опытных инженеров.

Система менеджмента качества компании отвечает требованиям в соответствии с ГОСТ Р ИСО 9001, ГОСТ РВ 0015-002 и ЭС РД 009

### Офис по работе с юридическими лицами:

105318, г.Москва, ул.Щербаковская д.3, офис 1107, 1118, ДЦ «Щербаковский»

Телефон: +7 495 668-12-70 (многоканальный)

Факс: +7 495 668-12-70 (доб.304)

E-mail: [info@moschip.ru](mailto:info@moschip.ru)

Skype отдела продаж:

moschip.ru

moschip.ru\_4

moschip.ru\_6

moschip.ru\_9