

Slotted Optical Switch

OPB830 and OPB840 (L and W)



Features:

- 0.125" (3.18 mm) wide slot
- Choice of electrical output parameters
- Choice of aperture
- Choice of opaque or IR transmissive shell material
- Side mount configuration
- Choice of lead spacing (L Series)
- 24" [610 mm] 26 AWG wire leads (W Series)



Description:

OPB830 and OPB840 series provide the design engineer with the flexibility of a custom device from a standard product line. The L Series offers a choice of PCBoard mount lead spacing, while the W Series offers 24" (610mm) 26AWG wire leads.

Building from a standard housing that utilizes a .375" (9.5 mm) wide slot, a user can specify the electrical output parameters, choice of aperture, discrete shell material, side mount configuration, and a choice of lead spacing (for the L Series) or 24" [610 mm] UL approved 26 AWG wire leads (W Series).

Housings are made from an opaque grade of injection-molded plastic that minimizes the assembly's sensitivity to visible and near-infrared ambient radiation. Discrete shells (exposed on the parallel faces inside the device throat) are made of either IR transmissive plastic (for applications where aperture contamination may occur) or of opaque plastic with aperture openings (for maximum protection against ambient light).

Switching of the phototransistor occurs whenever an opaque object passes through the slot and interrupts the beam.

Applications:

- Non-contact interruptive object sensing
- Assembly line automation
- Machine automation
- Equipment security
- Machine safety

General Note

TT Electronics reserves the right to make changes in product specification without notice or liability. All information is subject to TT Electronics' own data and is considered accurate at time of going to print.

TT Electronics | Optek Technology, Inc.
1645 Wallace Drive, Ste. 130, Carrollton, TX USA 75006 | Ph: +1 972 323 2200
www.ttelectronics.com | sensors@ttelectronics.com

Slotted Optical Switch

OPB830 and OPB840 (L and W)



Electrical Specifications

Absolute Maximum Ratings ($T_A=25^\circ\text{C}$ unless otherwise noted)

Storage and Operating Temperature L Series ⁽¹⁾ W Series ⁽¹⁾	-40° C to +85° C -40° C to +80° C
Lead Soldering Temperature [1/16 inch (1.6mm) from the case for 5 sec. with soldering iron] ⁽²⁾	260° C

Input Diode

Forward DC Current	50 mA
Peak Forward Current (1 μs pulse width, 300 pps)	1 A
Reverse DC Voltage	2 V
Power Dissipation ⁽¹⁾	100 mW

Output Phototransistor

Collector-Emitter Voltage	30 V
Emitter-Collector Voltage	5 V
Collector DC Current	30 mA
Power Dissipation ⁽¹⁾	100 mW

Electrical Characteristics ($T_A = 25^\circ\text{C}$ unless otherwise noted)

SYMBOL	PARAMETER	MIN	TYP	MAX	UNITS	TEST CONDITIONS
--------	-----------	-----	-----	-----	-------	-----------------

Input Diode LED (See OP240 for additional information—for reference only)

V_F	Forward Voltage	-	-	1.7	V	$I_F = 20\text{ mA}$
I_R	Reverse Current	-	-	100	μA	$V_R = 2\text{ V}$

Output Transistor (See OP550 for additional information—for reference only)

$V_{(BR)CEO}$	Collector-Emitter Breakdown Voltage	30	-	-	V	$I_C = 1\text{ mA}$
$V_{(BR)ECO}$	Emitter-Collector Breakdown Voltage	5	-	-	V	$I_E = 100\ \mu\text{A}$
I_{CEO}	Collector-Emitter Dark Current	-	-	100	nA	$V_{CE} = 10\text{ V}$

Notes:

- (1) Derate linearly 1.67 mW/° C above 25° C for L Series.
- (2) RMA flux is recommended. Duration can be extended to 10 seconds maximum when flow soldering.
- (3) Methanol or isopropanol are recommended as cleaning agents. Plastic housing is soluble in chlorinated hydrocarbons and ketones.
- (4) The W Series includes wire terminations of 24" (610 mm) 7-strand, 26 AWG UL insulated wire on each terminal. Each device incorporates a wire strain relief at the housing surface. The insulation functions and colors are: anode (red), cathode (black), phototransistor collector (white) and phototransistor emitter (green).
- (5) All parameters tested using pulse technique.

General Note

TT Electronics reserves the right to make changes in product specification without notice or liability. All information is subject to TT Electronics' own data and is considered accurate at time of going to print.

TT Electronics | Optek Technology, Inc.
1645 Wallace Drive, Ste. 130, Carrollton, TX USA 75006 | Ph: +1 972 323 2200
www.ttelectronics.com | sensors@ttelectronics.com

Slotted Optical Switch

OPB830 and OPB840 (L and W)



Electrical Characteristics ($T_A = 25^\circ\text{C}$ unless otherwise noted)

SYMBOL	PARAMETER	MIN	TYP	MAX	UNITS	TEST CONDITIONS
Combined						
$V_{CE(SAT)}$	Collector-Emitter Saturation Voltage Parameter A (OPB830L,OPB840L) (OPB835L, OPB845L) (OPB830W,OPB840W) (OPB835W, OPB845W)	-	-	0.4	V	$I_C = 400 \mu\text{A}, I_F = 20 \text{ mA}$
	Parameter B (OPB831L,OPB841L) (OPB836L,OPB846L) (OPB831W,OPB841W) (OPB836W,OPB846W)	-	-	0.4	V	$I_C = 800 \mu\text{A}, I_F = 10 \text{ mA}$
	Parameter C (OPB832L,OPB842L) (OPB837L,OPB847L) (OPB832W,OPB842W) (OPB837W,OPB847W)	-	-	0.6	V	$I_C = 1800 \mu\text{A}, I_F = 20 \text{ mA}$
$I_{C(ON)}$	On-State Collector Current Parameter A (OPB830L,OPB840L) (OPB835L, OPB845L) (OPB830W,OPB840W) (OPB835W, OPB845W)	0.625	-	-	mA	$V_{CE} = 10 \text{ V}, I_F = 20 \text{ mA}$
	Parameter B (OPB831L,OPB841L) (OPB836L,OPB846L) (OPB831W,OPB841W) (OPB836W,OPB846W)	1.250	-	-	mA	$V_{CE} = 5 \text{ V}, I_F = 10 \text{ mA}$
	Parameter C (OPB832L,OPB842L) (OPB837L,OPB847L) (OPB832W,OPB842W) (OPB837W,OPB847W)	2.250	-	-	mA	$V_{CE} = .6 \text{ V}, I_F = 20 \text{ mA}$

General Note
 TT Electronics reserves the right to make changes in product specification without notice or liability. All information is subject to TT Electronics' own data and is considered accurate at time of going to print.

TT Electronics | Optek Technology, Inc.
 1645 Wallace Drive, Ste. 130, Carrollton, TX USA 75006 | Ph: +1 972 323 2200
www.ttelectronics.com | sensors@ttelectronics.com

Slotted Optical Switch

OPB830 and OPB840 (L and W)



OPB8__ L11 - Flag Next to Emitter



OPB8__ L11 - Flag Next to Sensor

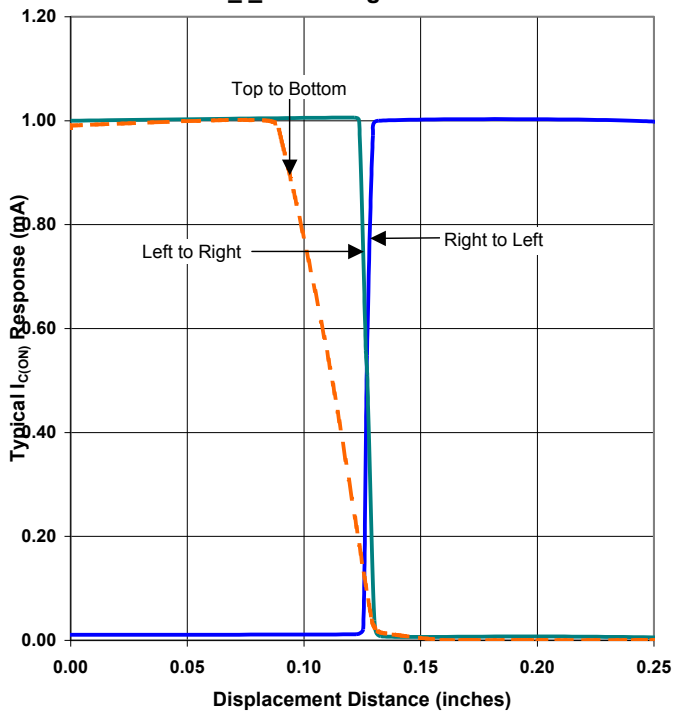

OPB8__ L11 - Flag in Middle of Slot



General Note
 TT Electronics reserves the right to make changes in product specification without notice or liability. All information is subject to TT Electronics' own data and is considered accurate at time of going to print.

TT Electronics | Optek Technology, Inc.
 1645 Wallace Drive, Ste. 130, Carrollton, TX USA 75006 | Ph: +1 972 323 2200
www.ttelectronics.com | sensors@ttelectronics.com

Slotted Optical Switch

OPB830 and OPB840 (L and W)



OPB8__ L51 - Flag Next to Emitter

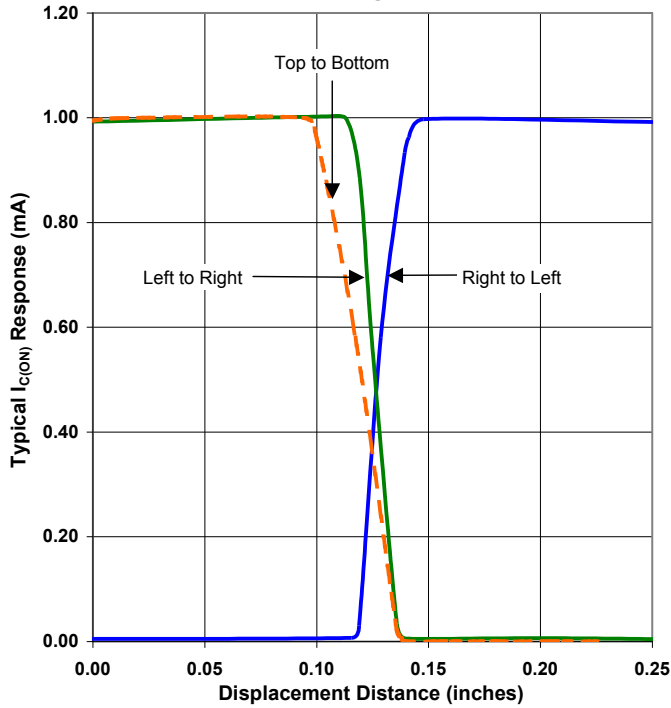

OPB8__ L51 - Flag Next to Sensor



OPB8__ L51 - Flag in Middle of Slot

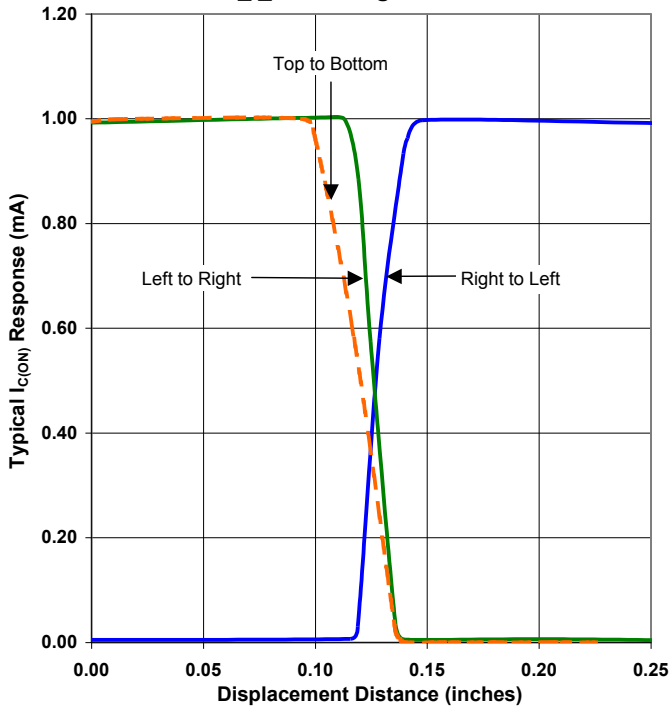

General Note
 TT Electronics reserves the right to make changes in product specification without notice or liability. All information is subject to TT Electronics' own data and is considered accurate at time of going to print.

TT Electronics | Optek Technology, Inc.
 1645 Wallace Drive, Ste. 130, Carrollton, TX USA 75006 | Ph: +1 972 323 2200
www.ttelectronics.com | sensors@ttelectronics.com

Slotted Optical Switch

OPB830 and OPB840 (L and W)



OPB8__ L55 - Flag Next to Emitter



OPB8__ L55 - Flag Next to Sensor



OPB8__ L55 - Flag in Middle of Slot



General Note

TT Electronics reserves the right to make changes in product specification without notice or liability. All information is subject to TT Electronics' own data and is considered accurate at time of going to print.

TT Electronics | Optek Technology, Inc.
1645 Wallace Drive, Ste. 130, Carrollton, TX USA 75006 | Ph: +1 972 323 2200
www.ttelectronics.com | sensors@ttelectronics.com

Slotted Optical Switch

OPB830 and OPB840 (L and W)



Packaging

OPB830/840L Series



DIMENSIONS ARE IN INCHES AND [MILLIMETERS].

OPB830/840W Series

Pin # / Color	Description
1 / Black	Cathode
2 / Red	Anode
3 / White	Collector
4 / Green	Emitter

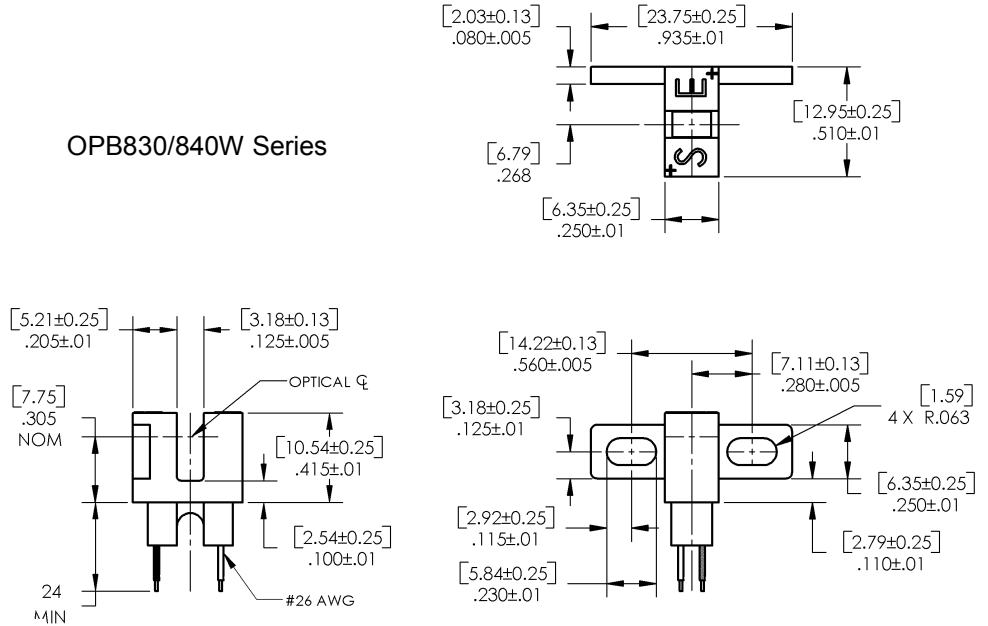

DIMENSIONS ARE IN INCHES AND [MILLIMETERS].

DIMENSIONS ARE IN: [MILLIMETERS]
INCHES

General Note

TT Electronics reserves the right to make changes in product specification without notice or liability. All information is subject to TT Electronics' own data and is considered accurate at time of going to print.

TT Electronics | Optek Technology, Inc.
1645 Wallace Drive, Ste. 130, Carrollton, TX USA 75006 | Ph: +1 972 323 2200
www.ttelectronics.com | sensors@ttelectronics.com

Slotted Optical Switch

OPB830 and OPB840 (L and W)



Part Number Guide — OPB8XX

OPB 8 X X L X X

Optek Assembly

Phototransistor Output Family

Discrete Shell Material:

- 3 — Side mount IR transmissive
Plastic discrete shell
- 4 — Side mount opaque
Plastic discrete shell

Sensor Aperture:

- 1 — 0.010" (0.25 mm)
- 5 — 0.050" (1.27 mm)

Emitter Aperture:

- 1 — 0.010" (0.25 mm)
- 5 — 0.050" (1.27 mm)

Mounting configurations:

- L — Solder lead termination

Electrical Specification Variations:

- 0 = Electrical Parameter A - (0.320" lead spacing)
- 1 = Electrical Parameter B - (0.320" lead spacing)
- 2 = Electrical Parameter C - (0.320" lead spacing)
- 5 = Electrical Parameter A - (0.220" lead spacing)
- 6 = Electrical Parameter B - (0.220" lead spacing)
- 7 = Electrical Parameter C - (0.220" lead spacing)

Notes:

- Assemblies with dual 0.010" apertures are currently available with electrical parameter "A" only.

Part Number Guide — OPB8XX

OPB 8 X X W X X Z

Optek Assembly

Phototransistor Output Family

Discrete Shell Material:

- 3 — Side mount IR transmissive
Plastic discrete shell
- 4 — Side mount opaque
Plastic discrete shell

Sensor Aperture:

- 1 — 0.010" (0.25 mm)
- 5 — 0.050" (1.27 mm)

Emitter Aperture:

- 1 — 0.010" (0.25 mm)
- 5 — 0.050" (1.27 mm)

Mounting configurations:

- W — Wire termination
 - Parts ending with "Z" meet RoHS requirements
 - Wires = 26 AWG—24" Long

Electrical Specification Variations:

- 0 = Electrical Parameter A
- 1 = Electrical Parameter B
- 2 = Electrical Parameter C

Notes:

- Assemblies with dual 0.010" apertures are currently available with electrical parameter "A" only.

General Note

TT Electronics reserves the right to make changes in product specification without notice or liability. All information is subject to TT Electronics' own data and is considered accurate at time of going to print.

TT Electronics | Optek Technology, Inc.
1645 Wallace Drive, Ste. 130, Carrollton, TX USA 75006 | Ph: +1 972 323 2200
www.ttelectronics.com | sensors@ttelectronics.com

Данный компонент на территории Российской Федерации

Вы можете приобрести в компании MosChip.

Для оперативного оформления запроса Вам необходимо перейти по данной ссылке:

<http://moschip.ru/get-element>

Вы можете разместить у нас заказ для любого Вашего проекта, будь то серийное производство или разработка единичного прибора.

В нашем ассортименте представлены ведущие мировые производители активных и пассивных электронных компонентов.

Нашей специализацией является поставка электронной компонентной базы двойного назначения, продукции таких производителей как XILINX, Intel (ex.ALTERA), Vicor, Microchip, Texas Instruments, Analog Devices, Mini-Circuits, Amphenol, Glenair.

Сотрудничество с глобальными дистрибьюторами электронных компонентов, предоставляет возможность заказывать и получать с международных складов практически любой перечень компонентов в оптимальные для Вас сроки.

На всех этапах разработки и производства наши партнеры могут получить квалифицированную поддержку опытных инженеров.

Система менеджмента качества компании отвечает требованиям в соответствии с ГОСТ Р ИСО 9001, ГОСТ РВ 0015-002 и ЭС РД 009

Офис по работе с юридическими лицами:

105318, г.Москва, ул.Щербаковская д.3, офис 1107, 1118, ДЦ «Щербаковский»

Телефон: +7 495 668-12-70 (многоканальный)

Факс: +7 495 668-12-70 (доб.304)

E-mail: info@moschip.ru

Skype отдела продаж:

moschip.ru

moschip.ru_4

moschip.ru_6

moschip.ru_9