

RoHS

Sxx08xSx & Sxx08x Series



Agency Approval

| Agency | Agency File Number |
|--------|--------------------|
| | L Package: E71639 |

Main Features

| Symbol | Value | Unit |
|-------------------|-------------|------|
| $I_{T(RMS)}$ | 8 | A |
| V_{DRM}/V_{RRM} | 400 to 1000 | V |
| I_{GT} | 0.2 to 15 | mA |

Description

Excellent unidirectional switches for phase control applications such as heating and motor speed controls. Sensitive gate SCRs are easily triggered with microAmps of current as furnished by sense coils, proximity switches, and microprocessors. Standard phase control SCRs are triggered with few milliampere of current at less than 1.5V potential.

Features & Benefits

- RoHS compliant
- Glass – passivated junctions
- Voltage capability up to 1000 V
- Surge capability up to 100 A

Applications

Typical applications are capacitive discharge systems for strobe lights, nailers, staplers and gas engine ignition. Also controls for power tools, home/brown goods and white goods appliances.

Internally constructed isolated packages are offered for ease of heat sinking with highest isolation voltage.

Schematic Symbol



Absolute Maximum Ratings – Sensitive SCRs

| Symbol | Parameter | Test Conditions | | Value | Unit |
|--------------|---|--|--------------------------|------------|------------------------|
| $I_{T(RMS)}$ | RMS on-state current | Sxx08LSy | $T_c = 80^\circ\text{C}$ | 8 | A |
| | | Sxx08RSy Sxx08DSy Sxx08VSy | $T_c = 95^\circ\text{C}$ | | |
| $I_{T(AV)}$ | Average on-state current | Sxx08LSy | $T_c = 80^\circ\text{C}$ | 5.1 | A |
| | | Sxx08RSy Sxx08DSy Sxx08VSy | $T_c = 95^\circ\text{C}$ | | |
| I_{TSM} | Peak non-repetitive surge current | single half cycle; $f = 50\text{Hz}$; T_J (initial) = 25°C | | 83 | A |
| | | single half cycle; $f = 60\text{Hz}$; T_J (initial) = 25°C | | 100 | |
| I^2t | I^2t Value for fusing | $t_p = 8.3 \text{ ms}$ | | 41 | A^2s |
| di/dt | Critical rate of rise of on-state current | $f = 60 \text{ Hz}; T_J = 110^\circ\text{C}$ | | 70 | $\text{A}/\mu\text{s}$ |
| I_{GTM} | Peak gate current | $T_J = 110^\circ\text{C}$ | | 1.6 | A |
| $P_{G(AV)}$ | Average gate power dissipation | $T_J = 110^\circ\text{C}$ | | 0.4 | W |
| T_{stg} | Storage temperature range | | | -40 to 150 | $^\circ\text{C}$ |
| T_J | Operating junction temperature range | | | -40 to 110 | $^\circ\text{C}$ |

Note: xx = voltage, y = sensitivity

Absolute Maximum Ratings – Standard SCRs

| Symbol | Parameter | Test Conditions | | Value | Unit |
|--------------|---|--|---------------------------|------------|------------------------|
| $I_{T(RMS)}$ | RMS on-state current | Sxx08L | $T_c = 100^\circ\text{C}$ | 8 | A |
| | | Sxx08R Sxx08D Sxx08V | $T_c = 110^\circ\text{C}$ | | |
| $I_{T(AV)}$ | Average on-state current | Sxx08L | $T_c = 100^\circ\text{C}$ | 5.1 | A |
| | | Sxx08R Sxx08D Sxx08V | $T_c = 110^\circ\text{C}$ | | |
| I_{TSM} | Peak non-repetitive surge current | single half cycle; $f = 50\text{Hz}$; T_J (initial) = 25°C | | 83 | A |
| | | single half cycle; $f = 60\text{Hz}$; T_J (initial) = 25°C | | 100 | |
| I^2t | I^2t Value for fusing | $t_p = 8.3 \text{ ms}$ | | 41 | A^2s |
| di/dt | Critical rate-of-rise of on-state current | $f = 60 \text{ Hz}; T_J = 125^\circ\text{C}$ | | 100 | $\text{A}/\mu\text{s}$ |
| I_{GM} | Peak gate current | $T_J = 125^\circ\text{C}$ | | 2 | A |
| $P_{G(AV)}$ | Average gate power dissipation | $T_J = 125^\circ\text{C}$ | | 0.5 | W |
| T_{stg} | Storage temperature range | | | -40 to 150 | $^\circ\text{C}$ |
| T_J | Operating junction temperature range | | | -40 to 125 | $^\circ\text{C}$ |

Note: xx = voltage

Electrical Characteristics ($T_J = 25^\circ\text{C}$, unless otherwise specified) – Sensitive SCRs

| Symbol | Test Conditions | | Value | | Unit |
|-----------|---|------|----------|----------|------------------|
| | | | Sxx08xS2 | Sxx08xS3 | |
| I_{GT} | $V_D = 6V$ $R_L = 100 \Omega$ | MAX. | 200 | 500 | μA |
| V_{GT} | | MAX. | 0.8 | | V |
| dv/dt | $V_D = V_{DRM}$; $R_{GK} = 1k\Omega$; $T_J = 110^\circ\text{C}$ | TYP. | 8 | | V/ μs |
| V_{GD} | $V_D = V_{DRM}$ $R_L = 3.3 k\Omega$ $T_J = 110^\circ\text{C}$ | MIN. | 0.2 | | V |
| V_{GRM} | $I_{GR} = 10\mu\text{A}$ | MIN. | 6 | | V |
| I_H | $I_T = 20\text{mA}$ (initial) | MAX. | 6 | 8 | mA |
| t_q | $I_T = 2\text{A}$; $t_p = 50\mu\text{s}$; $dv/dt = 5\text{V}/\mu\text{s}$; $di/dt = -30\text{A}/\mu\text{s}$ | MAX. | 50 | 45 | μs |
| t_{gt} | $I_G = 2 \times I_{GT}$ $PW = 15\mu\text{s}$ $I_T = 12\text{A}$ | TYP. | 4 | 5 | μs |

Note: xx = voltage x = package

Electrical Characteristics ($T_J = 25^\circ\text{C}$, unless otherwise specified) – Standard SCRs

| Symbol | Test Conditions | | | Value | Unit |
|----------|---|-------|------|--------|------------------|
| | | | | Sxx08x | |
| I_{GT} | $V_D = 12V$ $R_L = 60 \Omega$ | | MAX. | 15 | mA |
| V_{GT} | | | MAX. | 1.5 | V |
| dv/dt | $V_D = V_{DRM}$; gate open; $T_J = 100^\circ\text{C}$ | 400V | MIN. | 350 | V/ μs |
| | | 600V | | 300 | |
| | | 800V | | 250 | |
| | | 1000V | | 100 | |
| | $V_D = V_{DRM}$; gate open; $T_J = 125^\circ\text{C}$ | 400V | | 250 | |
| | | 600V | | 225 | |
| | | 800V | | 200 | |
| | | | | | |
| V_{GD} | $V_D = V_{DRM}$ $R_L = 3.3 k\Omega$ $T_J = 125^\circ\text{C}$ | | MIN. | 0.2 | V |
| I_H | $I_T = 200\text{mA}$ (initial) | | MAX. | 30 | mA |
| t_q | $I_T = 2\text{A}$; $t_p = 50\mu\text{s}$; $dv/dt = 5\text{V}/\mu\text{s}$; $di/dt = -30\text{A}/\mu\text{s}$ | | MAX. | 35 | μs |
| t_{gt} | $I_G = 2 \times I_{GT}$ $PW = 15\mu\text{s}$ $I_T = 16\text{A}$ | | TYP. | 2 | μs |

Note: xx = voltage x = package

Static Characteristics

| Symbol | Test Conditions | | | | Value | Unit | |
|---------------------|--|---------------------------|---------------------------|------------|-------|----------|---------------|
| V_{TM} | $I_T = 16\text{A}$; $t_p = 380 \mu\text{s}$ | | | | MAX. | 1.6 V | |
| I_{DRM} / I_{RRM} | $V_{DRM} = V_{RRM}$ | Sxx08xyy | $T_J = 25^\circ\text{C}$ | 400 - 600V | MAX. | 5 | μA |
| | | | $T_J = 110^\circ\text{C}$ | 400 - 600V | | 250 | |
| | | Sxx08x | $T_J = 25^\circ\text{C}$ | 400 - 800V | | 10 | |
| | | | | 1000V | | 20 | |
| | | | $T_J = 100^\circ\text{C}$ | 400 - 800V | | 200 | |
| | | | | 1000V | | 3000 | |
| | | $T_J = 125^\circ\text{C}$ | 400 - 800V | 500 | | | |

Note: xx = voltage, x = package, yy = sensitivity

Thermal Resistances

| Symbol | Parameter | Value | Unit | |
|-------------------|-----------------------|----------|------|------|
| $R_{\theta(J-C)}$ | Junction to case (AC) | Sxx08RSy | 1.8 | °C/W |
| | | Sxx08LSy | 3.4 | |
| | | Sxx08VSy | 2.1 | |
| | | Sxx08DSy | 1.5 | |
| | | Sxx08R | 1.8 | |
| | | Sxx08L | 3.4 | |
| | | Sxx08V | 2.0 | |
| | | Sxx08D | 1.5 | |
| $R_{\theta(J-A)}$ | Junction to ambient | Sxx08RSy | 40 | °C/W |
| | | Sxx08LSy | 65 | |
| | | Sxx08VSy | 85 | |
| | | Sxx08R | 40 | |
| | | Sxx08L | 50 | |
| | | Sxx08V | 70 | |

Note: xx = voltage, y = sensitivity

Figure 1: Normalized DC Gate Trigger Current vs. Junction Temperature (Sensitive SCR)

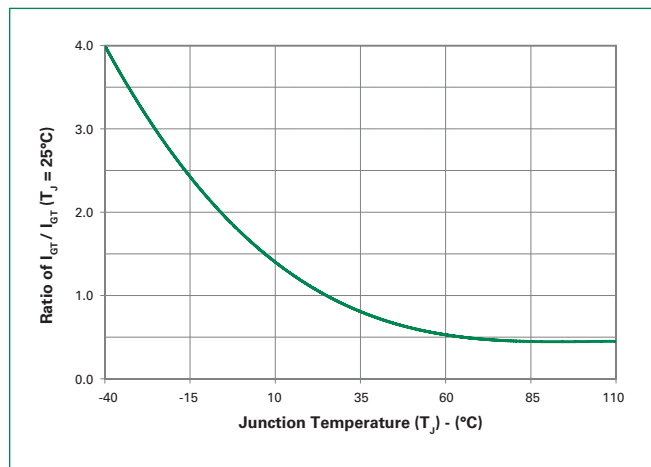

Figure 2: Normalized DC Gate Trigger Current vs. Junction Temperature (Standard SCR)

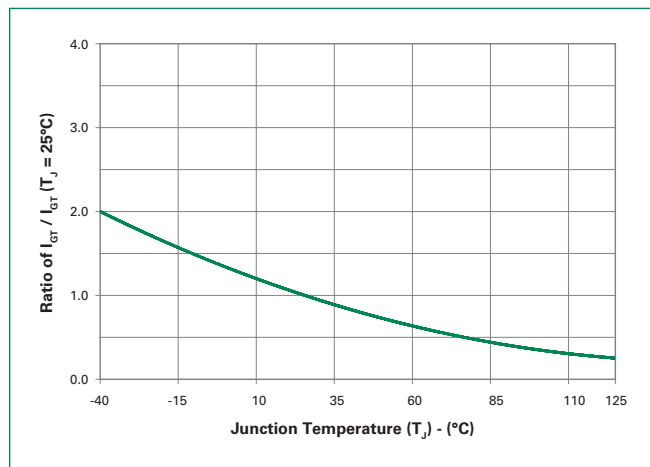

Figure 3: Normalized DC Gate Trigger Voltage vs. Junction Temperature



Figure 4: Normalized DC Holding Current vs. Junction Temperature

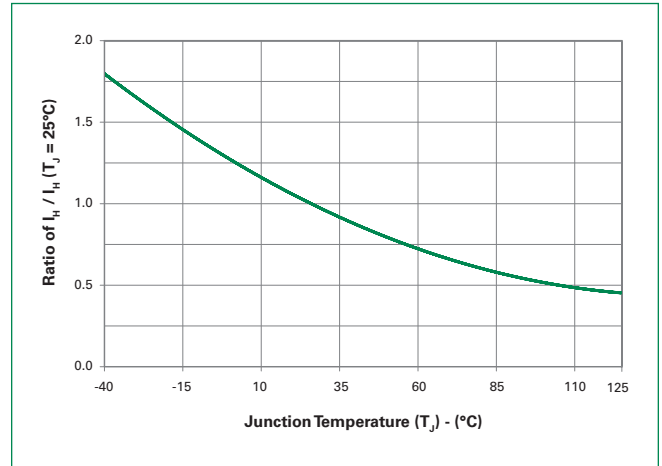

Figure 5: On-State Current vs. On-State Voltage (Typical)



Figure 6: Power Dissipation (Typical) vs. RMS On-State Current



Figure 7: Maximum Allowable Case Temperature vs. RMS On-State Current



Figure 8: Maximum Allowable Case Temperature vs. Average On-State Current



Figure 9: Maximum Allowable Ambient Temperature vs. RMS On-State Current



Note: xx = voltage, y = sensitivity

Figure 10: Maximum Allowable Ambient Temperature vs. Average On-State Current

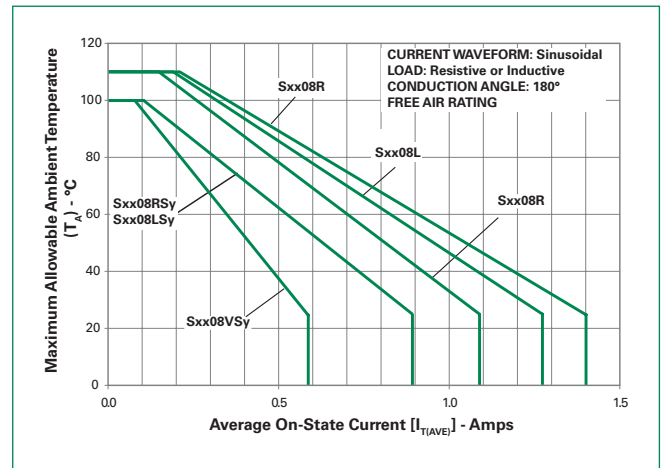

Figure 11: Peak Capacitor Discharge Current



Figure 12: Peak Capacitor Discharge Current Derating

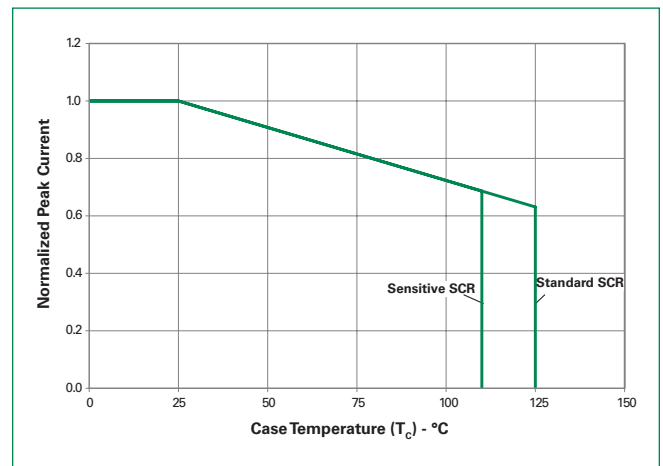
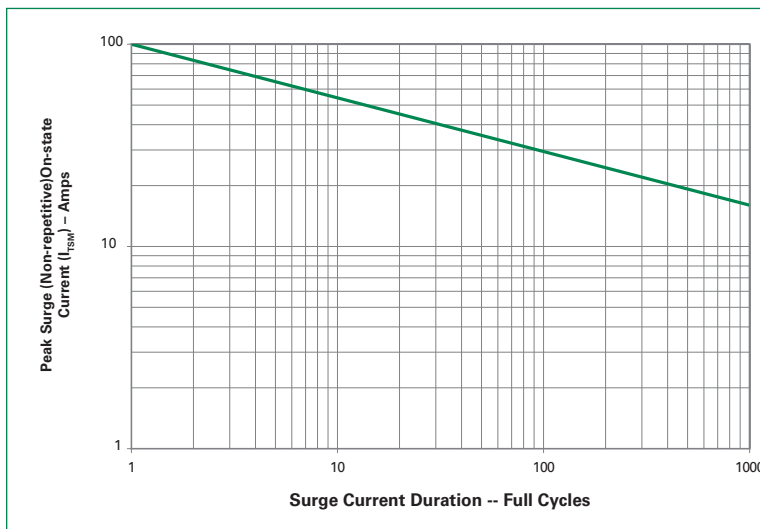

Figure 13: Surge Peak On-State Current vs. Number of Cycles



SUPPLY FREQUENCY: 60 Hz Sinusoidal
 LOAD: Resistive
 RMS On-State Current ($I_{T(RMS)}$): Maximum Rated Value at Specified Case Temperature

Notes:

1. Gate control may be lost during and immediately following surge current interval.
2. Overload may not be repeated until junction temperature has returned to steady-state rated value.

Soldering Parameters

| | | |
|--|------------------------------------|-------------------------|
| Reflow Condition | | Pb – Free assembly |
| Pre Heat | - Temperature Min ($T_{s(min)}$) | 150°C |
| | - Temperature Max ($T_{s(max)}$) | 200°C |
| | - Time (min to max) (t_s) | 60 – 180 secs |
| Average ramp up rate (Liquidus Temp (T_L) to peak) | | 5°C/second max |
| $T_{s(max)}$ to T_L - Ramp-up Rate | | 5°C/second max |
| Reflow | - Temperature (T_L) (Liquidus) | 217°C |
| | - Temperature (t_L) | 60 – 150 seconds |
| Peak Temperature (T_p) | | 260 ^{+0/-5} °C |
| Time within 5°C of actual peak Temperature (t_p) | | 20 – 40 seconds |
| Ramp-down Rate | | 5°C/second max |
| Time 25°C to peak Temperature (T_p) | | 8 minutes Max. |
| Do not exceed | | 280°C |



Physical Specifications

| | |
|------------------------|---|
| Terminal Finish | 100% Matte Tin-plated |
| Body Material | UL recognized epoxy meeting flammability classification 94V-0 |
| Lead Material | Copper Alloy |

Design Considerations

Careful selection of the correct device for the application's operating parameters and environment will go a long way toward extending the operating life of the Thyristor. Good design practice should limit the maximum continuous current through the main terminals to 75% of the device rating. Other ways to ensure long life for a power discrete semiconductor are proper heat sinking and selection of voltage ratings for worst case conditions. Overheating, overvoltage (including dv/dt), and surge currents are the main killers of semiconductors. Correct mounting, soldering, and forming of the leads also help protect against component damage.

Environmental Specifications

| Test | Specifications and Conditions |
|----------------------------------|---|
| AC Blocking | MIL-STD-750, M-1040, Cond A Applied Peak AC voltage @ 125°C for 1008 hours |
| Temperature Cycling | MIL-STD-750, M-1051, 100 cycles; -40°C to +150°C; 15-min dwell-time |
| Temperature/Humidity | EIA / JEDEC, JESD22-A101 1008 hours; 320V - DC: 85°C; 85% rel humidity |
| High Temp Storage | MIL-STD-750, M-1031, 1008 hours; 150°C |
| Low-Temp Storage | 1008 hours; -40°C |
| Thermal Shock | MIL-STD-750, M-1056 10 cycles; 0°C to 100°C; 5-min dwell-time at each temperature; 10 sec (max) transfer time between temperature |
| Autoclave | EIA / JEDEC, JESD22-A102 168 hours (121°C at 2 ATMs) and 100% R/H |
| Resistance to Solder Heat | MIL-STD-750 Method 2031 |
| Solderability | ANSI/J-STD-002, category 3, Test A |
| Lead Bend | MIL-STD-750, M-2036 Cond E |

Dimensions — TO-220AB (R-Package) — Non-Isolated Mounting Tab Common with Center Lead



| Dimension | Inches | | Millimeters | |
|-----------|--------|-------|-------------|-------|
| | Min | Max | Min | Max |
| A | 0.380 | 0.420 | 9.65 | 10.67 |
| B | 0.105 | 0.115 | 2.67 | 2.92 |
| C | 0.230 | 0.250 | 5.84 | 6.35 |
| D | 0.590 | 0.620 | 14.99 | 15.75 |
| E | 0.142 | 0.147 | 3.61 | 3.73 |
| F | 0.110 | 0.130 | 2.79 | 3.30 |
| G | 0.540 | 0.575 | 13.72 | 14.61 |
| H | 0.025 | 0.035 | 0.64 | 0.89 |
| J | 0.195 | 0.205 | 4.95 | 5.21 |
| K | 0.095 | 0.105 | 2.41 | 2.67 |
| L | 0.060 | 0.075 | 1.52 | 1.91 |
| M | 0.085 | 0.095 | 2.16 | 2.41 |
| N | 0.018 | 0.024 | 0.46 | 0.61 |
| O | 0.178 | 0.188 | 4.52 | 4.78 |
| P | 0.045 | 0.060 | 1.14 | 1.52 |
| R | 0.038 | 0.048 | 0.97 | 1.22 |

Dimensions — TO-220AB (L-Package) — Isolated Mounting Tab



| Dimension | Inches | | Millimeters | |
|-----------|--------|-------|-------------|-------|
| | Min | Max | Min | Max |
| A | 0.380 | 0.420 | 9.65 | 10.67 |
| B | 0.105 | 0.115 | 2.67 | 2.92 |
| C | 0.230 | 0.250 | 5.84 | 6.35 |
| D | 0.590 | 0.620 | 14.99 | 15.75 |
| E | 0.142 | 0.147 | 3.61 | 3.73 |
| F | 0.110 | 0.130 | 2.79 | 3.30 |
| G | 0.540 | 0.575 | 13.72 | 14.61 |
| H | 0.025 | 0.035 | 0.64 | 0.89 |
| J | 0.195 | 0.205 | 4.95 | 5.21 |
| K | 0.095 | 0.105 | 2.41 | 2.67 |
| L | 0.060 | 0.075 | 1.52 | 1.91 |
| M | 0.085 | 0.095 | 2.16 | 2.41 |
| N | 0.018 | 0.024 | 0.46 | 0.61 |
| O | 0.178 | 0.188 | 4.52 | 4.78 |
| P | 0.045 | 0.060 | 1.14 | 1.52 |
| R | 0.038 | 0.048 | 0.97 | 1.22 |

Dimensions — TO-251AA (V/I-Package) — V/I-PAK Through Hole



| Dimension | Inches | | | Millimeters | | |
|-----------|--------|-------|-------|-------------|------|------|
| | Min | Typ | Max | Min | Typ | Max |
| A | 0.040 | 0.044 | 0.050 | 1.02 | 1.11 | 1.27 |
| B | 0.235 | 0.242 | 0.245 | 5.97 | 6.15 | 6.22 |
| C | 0.350 | 0.361 | 0.375 | 8.89 | 9.18 | 9.53 |
| D | 0.205 | 0.208 | 0.213 | 5.21 | 5.29 | 5.41 |
| E | 0.255 | 0.262 | 0.265 | 6.48 | 6.66 | 6.73 |
| F | 0.027 | 0.031 | 0.033 | 0.69 | 0.80 | 0.84 |
| G | 0.087 | 0.090 | 0.093 | 2.21 | 2.28 | 2.36 |
| H | 0.085 | 0.092 | 0.095 | 2.16 | 2.34 | 2.41 |
| I | 0.176 | 0.180 | 0.184 | 4.47 | 4.57 | 4.67 |
| J | 0.018 | 0.020 | 0.023 | 0.46 | 0.51 | 0.58 |
| K | 0.038 | 0.040 | 0.044 | 0.97 | 1.01 | 1.12 |
| L | 0.018 | 0.020 | 0.023 | 0.46 | 0.52 | 0.58 |
| P | 0.042 | 0.047 | 0.052 | 1.06 | 1.20 | 1.32 |
| Q | 0.034 | 0.039 | 0.044 | 0.86 | 1.00 | 1.11 |
| R | 0.034 | 0.039 | 0.044 | 0.86 | 1.00 | 1.11 |
| S | 0.074 | 0.079 | 0.084 | 1.86 | 2.00 | 2.11 |

Dimensions — TO-252AA (D-Package) — D-PAK Surface Mount

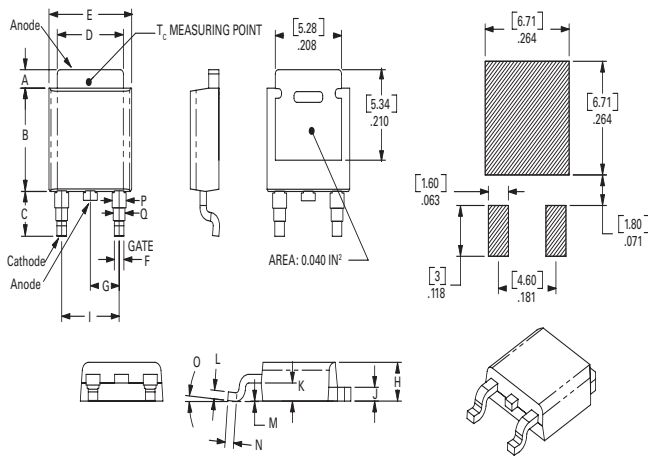

| Dimension | Inches | | | Millimeters | | |
|-----------|--------|-------|-------|-------------|------|------|
| | Min | Typ | Max | Min | Typ | Max |
| A | 0.040 | 0.043 | 0.050 | 1.02 | 1.09 | 1.27 |
| B | 0.235 | 0.243 | 0.245 | 5.97 | 6.16 | 6.22 |
| C | 0.106 | 0.108 | 0.113 | 2.69 | 2.74 | 2.87 |
| D | 0.205 | 0.208 | 0.213 | 5.21 | 5.29 | 5.41 |
| E | 0.255 | 0.262 | 0.265 | 6.48 | 6.65 | 6.73 |
| F | 0.027 | 0.031 | 0.033 | 0.69 | 0.80 | 0.84 |
| G | 0.087 | 0.090 | 0.093 | 2.21 | 2.28 | 2.36 |
| H | 0.085 | 0.092 | 0.095 | 2.16 | 2.33 | 2.41 |
| I | 0.176 | 0.179 | 0.184 | 4.47 | 4.55 | 4.67 |
| J | 0.018 | 0.020 | 0.023 | 0.46 | 0.51 | 0.58 |
| K | 0.038 | 0.040 | 0.044 | 0.97 | 1.02 | 1.12 |
| L | 0.018 | 0.020 | 0.023 | 0.46 | 0.51 | 0.58 |
| M | 0.000 | 0.000 | 0.004 | 0.00 | 0.00 | 0.10 |
| N | 0.021 | 0.026 | 0.027 | 0.53 | 0.67 | 0.69 |
| O | 0° | 0° | 5° | 0° | 0° | 5° |
| P | 0.042 | 0.047 | 0.052 | 1.06 | 1.20 | 1.32 |
| Q | 0.034 | 0.039 | 0.044 | 0.86 | 1.00 | 1.11 |

Product Selector

| Part Number | Voltage | | | | Gate Sensitivity | Type | Package |
|-------------|---------|------|------|-------|------------------|---------------|---------|
| | 400V | 600V | 800V | 1000V | | | |
| Sxx08RS2 | X | X | | | 0.2mA | Sensitive SCR | TO-220R |
| Sxx08LS2 | X | X | | | 0.2mA | Sensitive SCR | TO-220L |
| Sxx08VS2 | X | X | | | 0.2mA | Sensitive SCR | TO-251 |
| Sxx08DS2 | X | X | | | 0.2mA | Sensitive SCR | TO-252 |
| Sxx08RS3 | X | X | | | 0.5mA | Sensitive SCR | TO-220R |
| Sxx08LS3 | X | X | | | 0.5mA | Sensitive SCR | TO-220L |
| Sxx08VS3 | X | X | | | 0.5mA | Sensitive SCR | TO-251 |
| Sxx08DS3 | X | X | | | 0.5mA | Sensitive SCR | TO-252 |
| Sxx08R | X | X | X | X | 15mA | Standard SCR | TO-220R |
| Sxx08L | X | X | X | X | 15mA | Standard SCR | TO-220L |
| Sxx08V | X | X | X | X | 15mA | Standard SCR | TO-251 |
| Sxx08D | X | X | X | X | 15mA | Standard SCR | TO-252 |

Note: xx = Voltage

Packing Options

| Part Number | Marking | Weight | Packing Mode | Base Quantity |
|--------------|------------|--------|------------------|-------------------|
| Sxx08L/Ryy | Sxx08L/Ryy | 2.2 g | Bulk | 500 |
| Sxx08L/RyyTP | Sxx08L/Ryy | 2.2 g | Tube | 500 (50 per tube) |
| Sxx08DyyTP | Sxx08Dyy | 0.3 g | Tube | 750 (75 per tube) |
| Sxx08DyyRP | Sxx08Dyy | 0.3 g | Embossed Carrier | 2500 |
| Sxx08VyyTP | Sxx08Vyy | 0.4 g | Tube | 750 (75 per tube) |
| Sxx08L/R | Sxx08L/R | 2.2 g | Bulk | 500 |
| Sxx08L/RTP | Sxx08L/R | 2.2 g | Tube | 500 (50 per tube) |
| Sxx08DTP | Sxx08D | 0.3 g | Tube | 750 (75 per tube) |
| Sxx08DRP | Sxx08D | 0.3 g | Embossed Carrier | 2500 |
| Sxx08VTP | Sxx08V | 0.4 g | Tube | 750 (75 per tube) |

Note: xx = Voltage; yy = Sensitivity

TO-252 Embossed Carrier Reel Pack (RP) Specifications

Meets all EIA-481-2 Standards

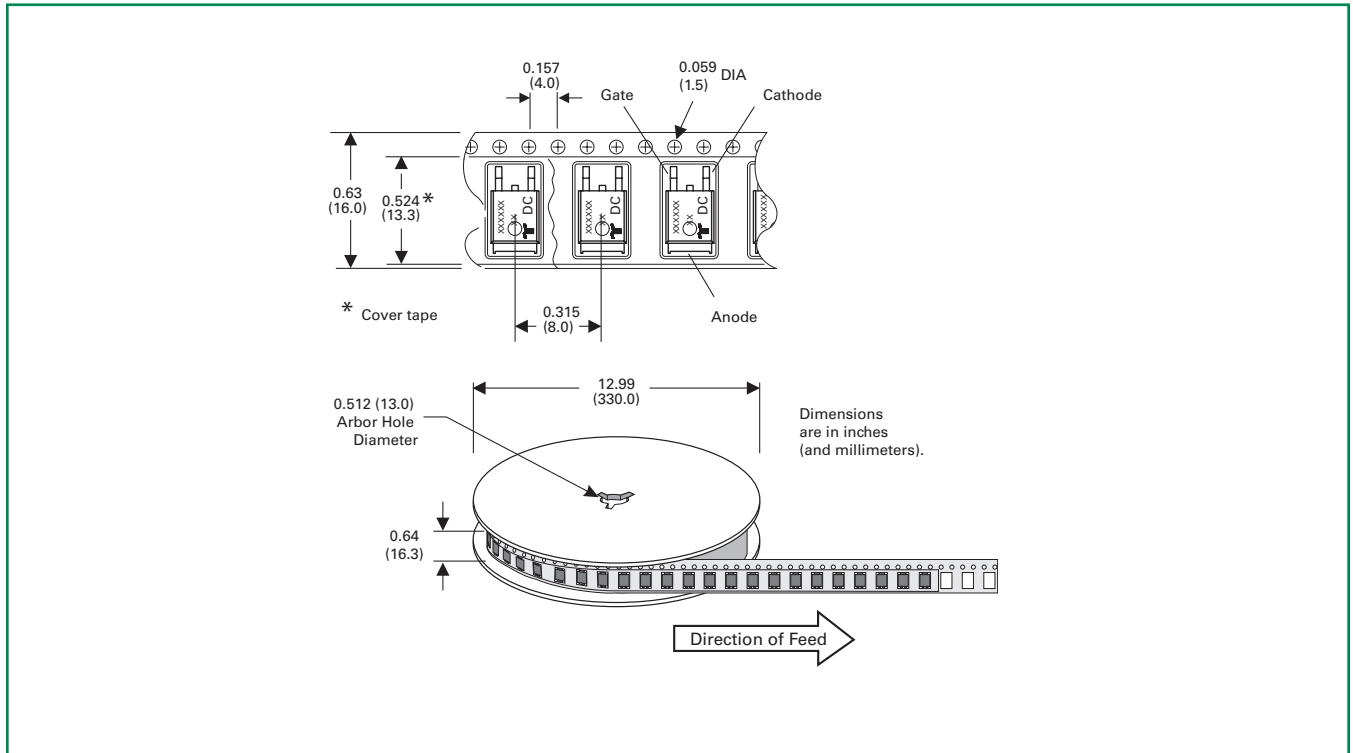

Part Numbering System

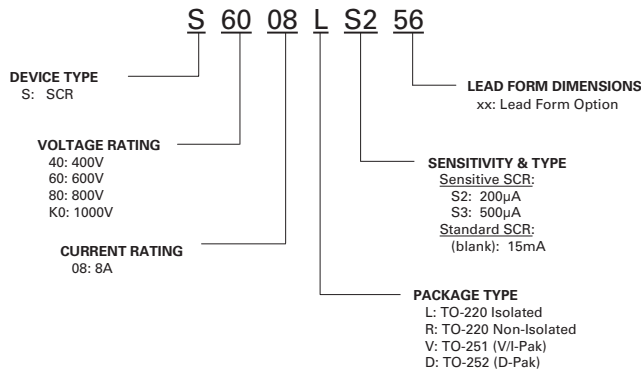

Part Marking System

TO-220 AB – (R Package)

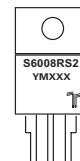

TO-220 AB – (L Package)

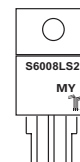

TO-251AA – (V Package)
TO-252AA – (D Package)

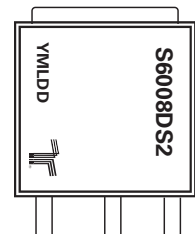

Данный компонент на территории Российской Федерации

Вы можете приобрести в компании MosChip.

Для оперативного оформления запроса Вам необходимо перейти по данной ссылке:

<http://moschip.ru/get-element>

Вы можете разместить у нас заказ для любого Вашего проекта, будь то серийное производство или разработка единичного прибора.

В нашем ассортименте представлены ведущие мировые производители активных и пассивных электронных компонентов.

Нашей специализацией является поставка электронной компонентной базы двойного назначения, продукции таких производителей как XILINX, Intel (ex.ALTERA), Vicor, Microchip, Texas Instruments, Analog Devices, Mini-Circuits, Amphenol, Glenair.

Сотрудничество с глобальными дистрибьюторами электронных компонентов, предоставляет возможность заказывать и получать с международных складов практически любой перечень компонентов в оптимальные для Вас сроки.

На всех этапах разработки и производства наши партнеры могут получить квалифицированную поддержку опытных инженеров.

Система менеджмента качества компании отвечает требованиям в соответствии с ГОСТ Р ИСО 9001, ГОСТ РВ 0015-002 и ЭС РД 009

Офис по работе с юридическими лицами:

105318, г.Москва, ул.Щербаковская д.3, офис 1107, 1118, ДЦ «Щербаковский»

Телефон: +7 495 668-12-70 (многоканальный)

Факс: +7 495 668-12-70 (доб.304)

E-mail: info@moschip.ru

Skype отдела продаж:

moschip.ru

moschip.ru_4

moschip.ru_6

moschip.ru_9