

STEP-UP DC/DC CONVERTER FOR OLED BACK LIGHT with SHUTDOWN FUNCTION

NO.EA-192-140530

OUTLINE

R1200x series are CMOS-based control type step-up DC/DC converter with low supply current ICs. Each of these ICs consists of a Nch MOSFET, NPN transistor, an oscillator, PWM comparator, a voltage reference unit, an error amplifier, a current limit circuit, an under voltage lockout circuit (UVLO), an over voltage protection circuit (OVP), and a soft start circuit. As the external components, an inductor, resistances or capacitors are necessary to make a constant output voltage of step-up DC/DC converter with the R1200x. At standby mode, the NPN transistor can separate the output from the input. During the situation of that, there are two versions. R1200xxxxA: the output of V_{OUT} is generated to 0V by the low resistance (with the auto discharge function). R1200xxxxB does not generate the output of V_{OUT} (without the auto discharge function).

The soft-start time (Typ. 1.5ms) and the maximum duty cycle (Typ. 91%) are set internally. For the protection functions of R1200x series are the current limit function of the L_x peak current, the OVP function for detection the over voltage of output and the UVLO function for protective miss-operation by the low voltage. (The threshold of OVP is selectable from 17V, 19V or 21V.)

Since the packages for these ICs are DFN1616-6, DFN(PLP)1820-6, SOT-23-6 and WLCSP-6-P1, therefore high density mounting of the ICs on boards is possible.

FEATURES

- Supply Current Typ. 500 μ A
- Standby Current Max. 3 μ A
- Input Voltage Range 2.3V to 5.5V
- Feedback Voltage 1.0V (Externally adjustable)
- Feedback Voltage Accuracy $\pm 1.5\%$
- Temperature-Drift Coefficient of Feedback Voltage ± 150 ppm/ $^{\circ}$ C
- Oscillator Frequency Typ. 1.2MHz
- Maximum Duty Cycle Typ. 91%
- Switch ON Resistance Typ. 1.35 Ω
- UVLO Detector Threshold Typ. 2.0V
- Soft-start Time Typ. 1.5ms
- L_x Current Limit Protection Typ. 700mA
- OVP Detector Threshold 17V, 19V, 21V
- Switching Control PWM
- Built-in a rectifier NPN transistor, at standby mode, complete shutdown is possible.
- Built-in Auto discharge function A version
- Packages DFN1616-6, DFN(PLP)1820-6, SOT-23-6,
WLCSP-6-P1
- Ceramic capacitors are recommended 1 μ F

APPLICATION

- OLED power supply for portable equipment
- White LED Backlight for portable equipment

R1200x

BLOCK DIAGRAMS

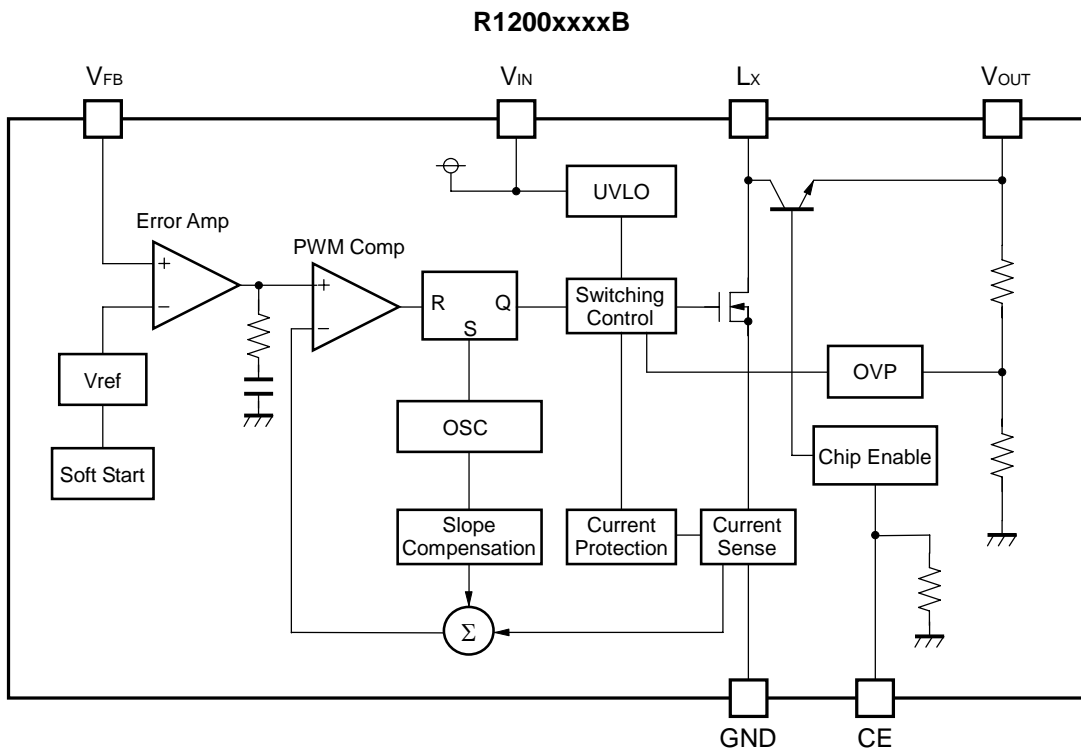

* R1200Z (WLCSP-6-P1) is the limited product. As of March in 2014.

R1200x

SELECTION GUIDE

The OVP threshold voltage, auto discharge function, and the package for the ICs can be selected at the user's request.

Product Name	Package	Quantity per Reel	Pb Free	Halogen Free
R1200Zxxx*-E2-F	WLCSP-6-P1	5,000 pcs	Yes	Yes
R1200Lxxx*-TR	DFN1616-6	5,000 pcs	Yes	Yes
R1200Kxxx*-TR	DFN(PLP)1820-6	5,000 pcs	Yes	Yes
R1200Nxxx*-TR-FE	SOT-23-6	3,000 pcs	Yes	Yes
xxx : Designation of OVP detector threshold (001) 17V threshold of OVP (002) 19V threshold of OVP (003) 21V threshold of OVP				
* : The auto discharge function at off state are options as follows. (A) with auto discharge function at off state (B) without auto discharge function at off state				

PIN CONFIGURATIONS

• WLCSP-6-P1

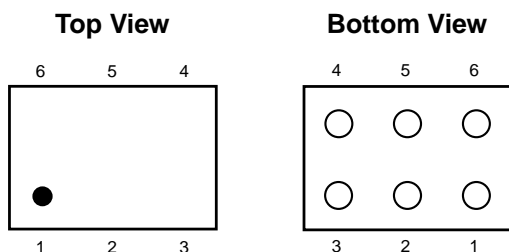

• DFN1616-6



• DFN(PLP)1820-6



• SOT-23-6



PIN DESCRIPTIONS

• WLCSP-6-P1

Pin No	Symbol	Pin Description
1	LX	Switching Pin (Open Drain Output)
2	V _{IN}	Power Supply Input Pin
3	V _{FB}	Feedback Pin
4	CE	Chip Enable Pin ("H" Active)
5	V _{OUT}	Output Pin
6	GND	Ground Pin

• DFN1616-6, DFN(PLP)1820-6

Pin No	Symbol	Pin Description
1	CE	Chip Enable Pin ("H" Active)
2	V _{FB}	Feedback Pin
3	LX	Switching Pin (Open Drain Output)
4	GND	Ground Pin
5	V _{DD}	Input Pin
6	V _{OUT}	Output Pin

*) Tab is GND level. (They are connected to the reverse side of this IC.)

The tab is better to be connected to the GND, but leaving it open is also acceptable.

* R1200Z (WLCSP-6-P1) is the limited product. As of March in 2014.

R1200x

• SOT-23-6

Pin No	Symbol	Pin Description
1	CE	Chip Enable Pin ("H" Active)
2	V _{OUT}	Output Pin
3	V _{DD}	Input Pin
4	L _X	Switching Pin (Open Drain Output)
5	GND	Ground Pin
6	V _{FB}	Feedback Pin

ABSOLUTE MAXIMUM RATINGS

GND=0V

Symbol	Item	Rating	Unit
V _{IN}	V _{IN} Pin Voltage	-0.3 to 6.5	V
V _{CE}	CE Pin Voltage	-0.3 to V _{IN} +0.3	V
V _{FB}	V _{FB} Pin Voltage	-0.3 to V _{IN} +0.3	V
V _{OUT}	V _{OUT} Pin Voltage	-0.3 to 25.0	V
V _{LX}	L _X Pin Voltage	-0.3 to 25.0	V
I _{LX}	L _X Pin Current	1000	mA
P _D	Power Dissipation (WLCSP-6-P1)*	633	mW
	Power Dissipation (DFN1616-6)*	640	
	Power Dissipation (DFN(PLP)1820-6)*	880	
	Power Dissipation (SOT-23-6)*	420	
T _{opt}	Operating Temperature Range	-40 to 85	°C
T _{stg}	Storage Temperature Range	-55 to 125	°C

*) For Power Dissipation, please refer to PACKAGE INFORMATION.

ABSOLUTE MAXIMUM RATINGS

Electronic and mechanical stress momentarily exceeded absolute maximum ratings may cause the permanent damages and may degrade the life time and safety for both device and system using the device in the field. The functional operation at or over these absolute maximum ratings is not assured.

R1200x

ELECTRICAL CHARACTERISTICS

• R1200x

T_{opt}=25°C

Symbol	Item	Conditions	Min.	Typ.	Max.	Unit	
V _{IN}	Operating Input Voltage		2.3		5.5	V	
I _{DD}	Supply Current	V _{IN} =5.5V, V _{FB} =0V, Lx at no load		0.5	1.0	mA	
I _{standby}	Standby Current	V _{IN} =5.5V, V _{CE} =0V		0	3.0	μA	
V _{UVLO1}	UVLO Detector Threshold	V _{IN} falling	1.9	2.0	2.1	V	
V _{UVLO2}	UVLO Released Voltage	V _{IN} rising		V _{UVLO1} +0.10	2.25	V	
V _{CEH}	CE Input Voltage "H"	V _{IN} =5.5V	1.5			V	
V _{CEL}	CE Input Voltage "L"	V _{IN} =2.3V			0.5	V	
R _{CE}	CE Pull Down Resistance	V _{IN} =3.6V	600	1200	2200	kΩ	
V _{FB}	V _{FB} Voltage Accuracy	V _{IN} =3.6V	0.985	1.0	1.015	V	
ΔV _{FB} / ΔT _{opt}	V _{FB} Voltage Temperature Coefficient	V _{IN} =3.6V, -40°C ≤ T _{opt} ≤ 85°C		±150		ppm /°C	
I _{FB}	V _{FB} Input Current	V _{IN} =5.5V, V _{FB} =0V or 5.5V	-0.1		0.1	μA	
t _{start}	Soft-start Time	V _{IN} =3.6V		1.5		ms	
R _{ON}	Switch ON Resistance	V _{IN} =3.6V, I _{SW} =100mA		1.35		Ω	
I _{LXleak}	Switch Leakage Current			0	3.0	μA	
I _{LXlim}	Switch Current Limit	V _{IN} =3.6V	400	700	1000	mA	
V _{NPN}	NPN V _{CE} Voltage	I _{NPN} =100mA		0.8		V	
I _{NPNOFF1}	NPN Leakage Current 1	V _{OUT} =23V			10	μA	
I _{NPNOFF2}	NPN Leakage Current 2	V _{OUT} =0V, V _{LX} =5.5V			3.0	μA	
f _{osc}	Oscillator Frequency	V _{IN} =3.6V, V _{OUT} =V _{FB} =0V	1.0	1.2	1.4	MHz	
Maxduty	Maximum Duty Cycle	V _{IN} =3.6V, V _{OUT} =V _{FB} =0V	86	91		%	
V _{OVP1}	OVP Detector Threshold	V _{IN} =3.6V, V _{OUT} rising	R1200x001x	16	17	18	V
			R1200x002x	18	19	20	
			R1200x003x	20	21	22	
V _{OVP2}	OVP Released Voltage	V _{IN} =3.6V, V _{OUT} falling		V _{OVP1} -1.1		V	
I _{DISCHG}	V _{OUT} Discharge Current	V _{IN} =3.6V, V _{OUT} =0.1V	R1200xxxxA	0.7		mA	
I _{VOUT}	OVP Sense Current	V _{IN} =3.6V, V _{OUT} =23V		6.0		μA	

RECOMMENDED OPERATING CONDITIONS (ELECTRICAL CHARACTERISTICS)

All of electronic equipment should be designed that the mounted semiconductor devices operate within the recommended operating conditions. The semiconductor devices cannot operate normally over the recommended operating conditions, even if when they are used over such conditions by momentary electronic noise or surge. And the semiconductor devices may receive serious damage when they continue to operate over the recommended operating conditions.

TYPICAL APPLICATIONS



Symbol	Parts Recommendation
L1	22µH LQH32CN220K53L (Murata)
C1	1µF
C2	1µF GRM21BR11E105K (Murata)
C3	220pF
R1, R2	For V _{OUT} setting
R3	2kΩ

● The Method of Output Voltage Setting

- The output voltage can be calculated with divider resistors (R1 and R2) values as the following formula:

$$\text{Output Voltage} = V_{\text{FB}} \times (R1 + R2) / R1$$

- The total value of R1 and R2 should be equal or less than 300kΩ. Make the V_{IN} and GND line sufficient. The large current flows through the V_{IN} and GND line due to the switching. If this impedance (V_{IN} and GND line) is high, the internal voltage of the IC may shift by the switching current, and the operating may become unstable. Moreover, when the built-in L_x switch is turn OFF, the spike noise caused by the inductor may be generated. As a result of this, recommendation voltage rating of capacitor (C2) value is equal 1.5 times larger or more than the setting output voltage.

● Shutdown

- At standby mode, the output is completely separated from the input and shutdown by the NPN transistor of internal IC. However, the leakage current is generated when the L_x pin voltage is equal or more than V_{IN} pin voltage at standby mode.
- R1200xxxxA (with auto discharge function): In the term of standby mode, the switch is turned ON between V_{OUT} to GND and the V_{OUT} capacitor is discharged.
- R1200xxxxB (without auto discharge function): The built-in switch for discharge does not turn on, but the OVP sense resistors between V_{OUT} and GND exists as same as A version.
- However, the both version (A/B) has the OVP sense resistance (4 to 5MΩ) between V_{OUT} and GND (refer to OVP sense current (I_{VOUT}) on ELECTRICAL CHARACTERISTICS table) and the current flows through from V_{OUT} to GND.

● Selection of external components

- The recommendation of capacitor value for C1 is in the range from 1µF to 4.7µF. Connect C1 with a capacitance value between V_{IN} and GND pin, and as close as possible to the pins.
- Connect a capacitor in the range from 1µF to 4.7µF between V_{OUT} and GND pins.
- The recommendation of inductance value is in the range from 4.7µH - 22µH. Choose an inductor of which the DC resistance is small enough and the permissible current is large enough and be hard for magnetic saturation. If the inductance value is too small, at the maximum load the peak current may be large and reach the current limit of L_x. (Refer to the item of the operation of the DC/DC converter and output current.)

R1200x

- If the spike noise of V_{OUT} may be large, the spike noise may be picked into V_{FB} pin and make the operation unstable. In this case, use a R3 of the resistance value in the range from $1k\Omega$ to $5k\Omega$ to reduce a noise level of V_{FB} .
- * The performance of power source circuits using these ICs extremely depends upon the peripheral circuits. Pay attention in the selection of the peripheral circuits. In particular, design the peripheral circuits in a way that the values such as voltage, current, and power of each component, PCB patterns and the IC do not exceed their respected rated values.

OPERATION OF STEP-UP DC/DC CONVERTER AND OUTPUT CURRENT

<Basic Circuit>

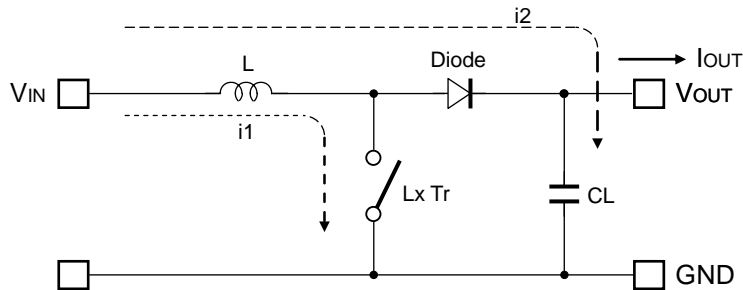

<Current through L>

Discontinuous mode

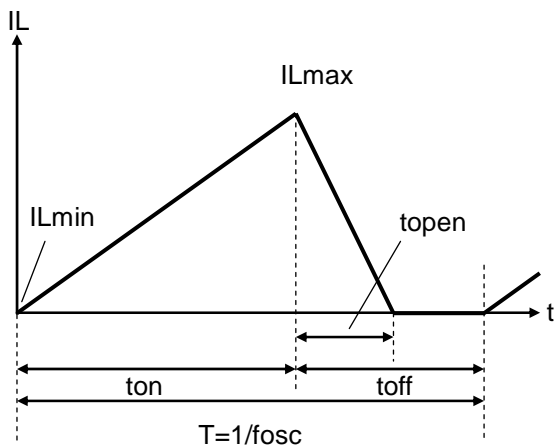

Continuous mode

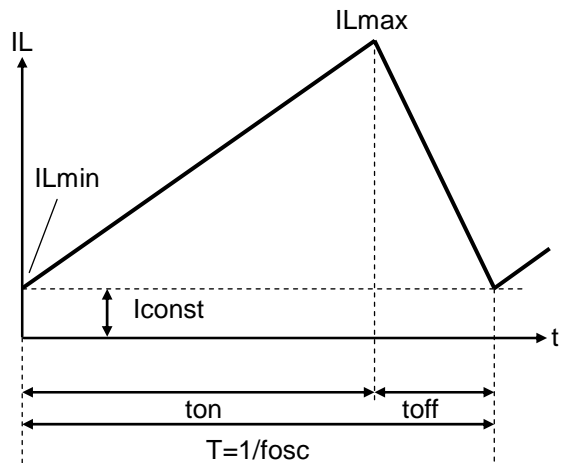

There are two operation modes of the step-up PWM control-DC/DC converter. That is the continuous mode and discontinuous mode by the continuousness inductor.

When the transistor turns ON, the voltage of inductor L becomes equal to V_{IN} voltage. The increase value of inductor current (i_1) will be

$$\Delta i_1 = V_{IN} \times t_{on} / L \dots\dots\dots \text{Formula 1}$$

As the step-up circuit, during the OFF time (when the transistor turns OFF) the voltage is continually supply from the power supply. The decrease value of inductor current (i_2) will be

$$\Delta i_2 = (V_{OUT} - V_{IN}) \times t_{open} / L \dots\dots\dots \text{Formula 2}$$

At the PWM control-method, the inductor current become continuously when $t_{open} = t_{off}$, the DC/DC converter operate as the continuous mode.

R1200x

In the continuous mode, the variation of current of i_1 and i_2 is same at regular condition.

$$V_{IN} \times t_{on} / L = (V_{OUT} - V_{IN}) \times t_{off} / L \dots \dots \dots \text{Formula 3}$$

The duty at continuous mode will be

$$\text{duty (\%)} = t_{on} / (t_{on} + t_{off}) = (V_{OUT} - V_{IN}) / V_{OUT} \dots \dots \dots \text{Formula 4}$$

The average value of inductor current (i_1) when $t_{open}=t_{off}$ will be

$$i_1 (\text{Ave.}) = V_{IN} \times t_{on} / (2 \times L) \dots \dots \dots \text{Formula 5}$$

If the input power is equal to the output power, it becomes the continuous mode if the I_{OUT} value is larger than the value will be calculated by following formula.

$$I_{OUT} = V_{IN}^2 \times t_{on} / (2 \times L \times V_{OUT}) \dots \dots \dots \text{Formula 6}$$

The peak current (I_{Lmax}) of inductor will be

$$I_{Lmax} = I_{OUT} \times V_{OUT} / V_{IN} + V_{IN} \times t_{on} / (2 \times L)$$
$$I_{Lmax} = I_{OUT} \times V_{OUT} / V_{IN} + V_{IN} \times T \times (V_{OUT} - V_{IN}) / (2 \times L \times V_{OUT}) \dots \dots \dots \text{Formula 7}$$

The peak current value is larger than the I_{OUT} value. In case of this, selecting the condition of the input and the output and the external components by considering of I_{Lmax} value.

The explanation above is based on the ideal calculation, and the loss caused by L_x switch and the external components are not included.

The actual maximum output current will be between 50% and 80% by the above calculations. Especially, when the I_L is large or V_{IN} is low, the loss of V_{IN} is generated with on resistance of the switch.

TYPICAL CHARACTERISTICS

1) Output Voltage vs. Output Current ($L=22\mu\text{H}$)

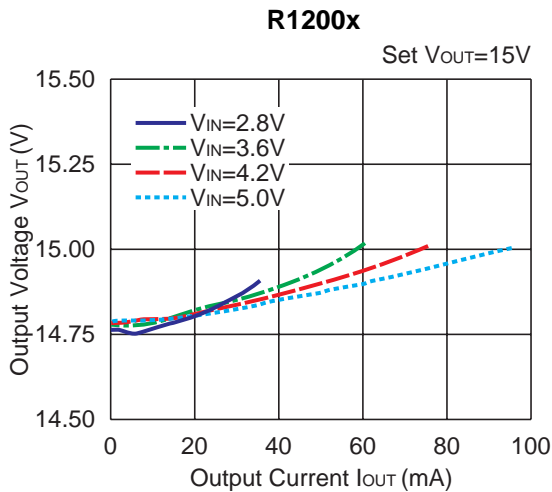
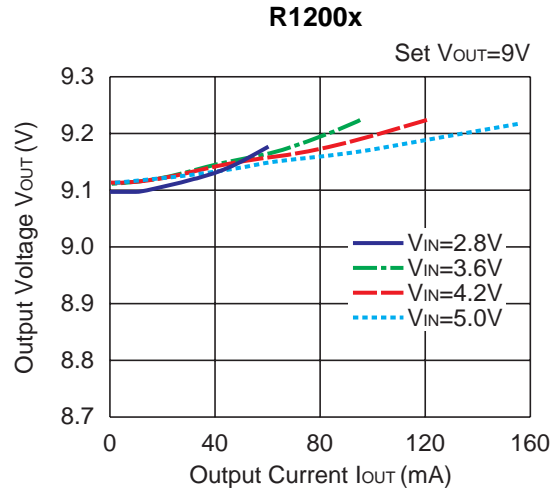
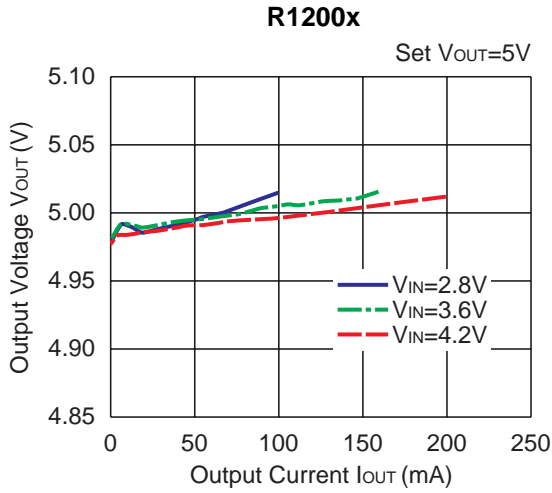

2) Efficiency vs. Output Current



R1200x

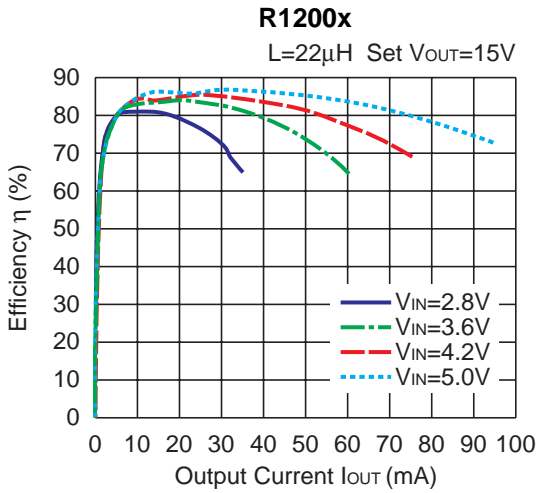
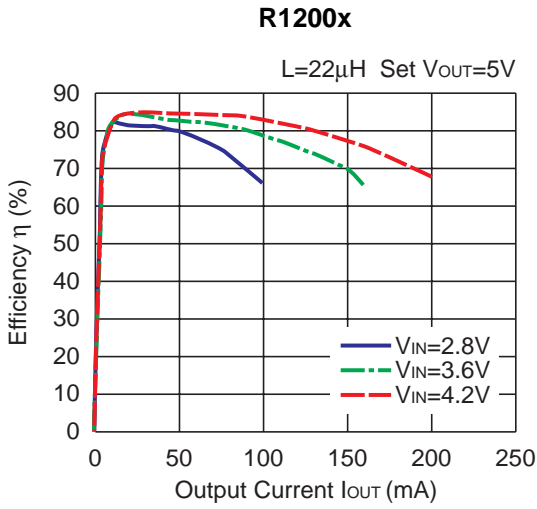

3) OVP Sense Current vs. Temperature



4) Supply Current vs. Temperature



5) CE Pulldown Resistance vs. Temperature

R1200x

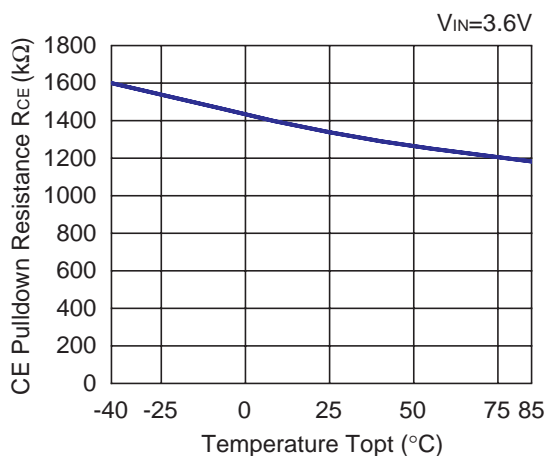

6) CE Input Voltage "L" vs. Temperature

R1200x

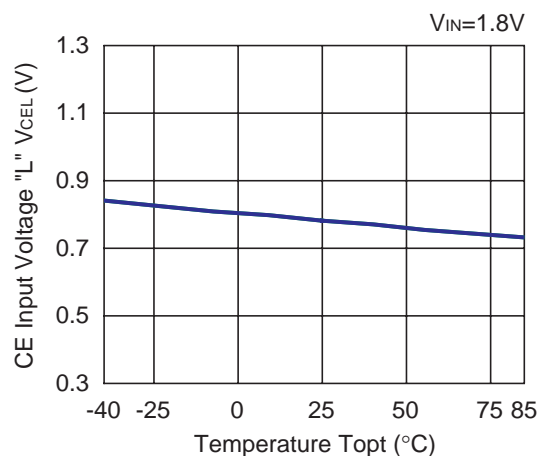

7) CE Input Voltage "H" vs. Temperature

R1200x

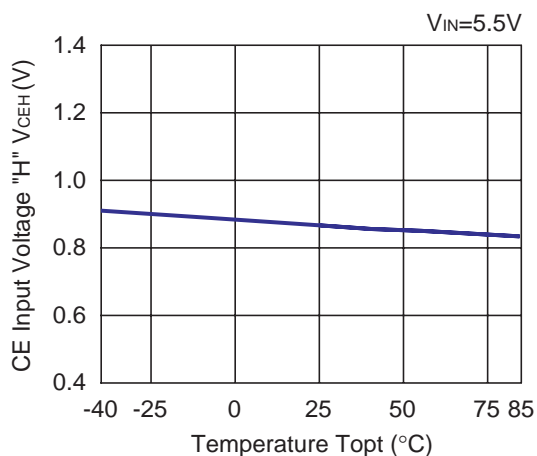

8) NPN V_{CE} Voltage vs. Temperature

R1200x

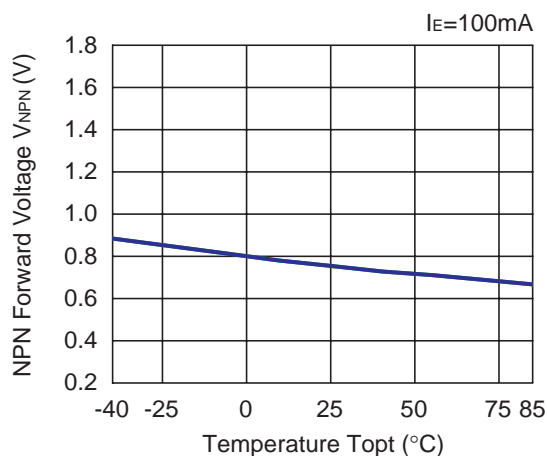

9) V_{FB} Voltage vs. Temperature

R1200x

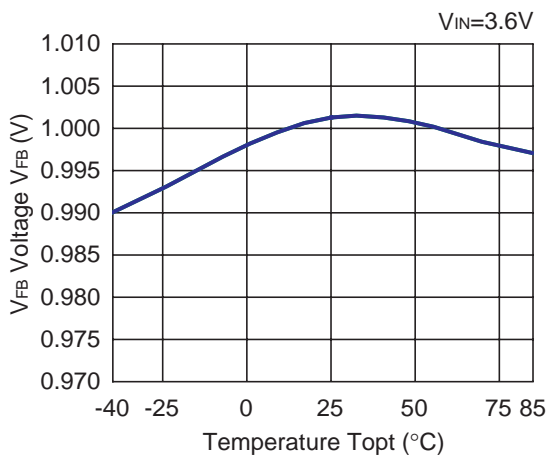

10) UVLO Detect / Released Voltage vs. Temperature

R1200x

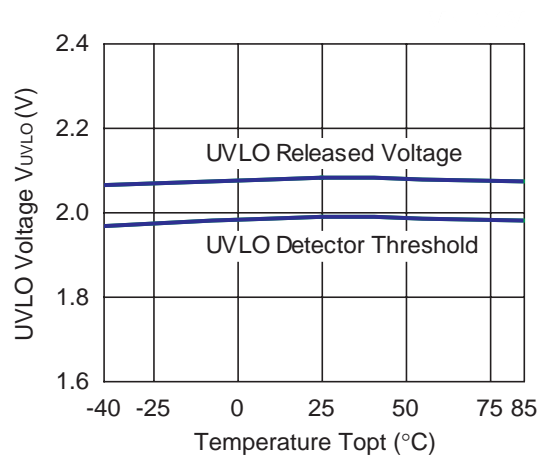

R1200x

11) Oscillator Frequency vs. Temperature

R1200x

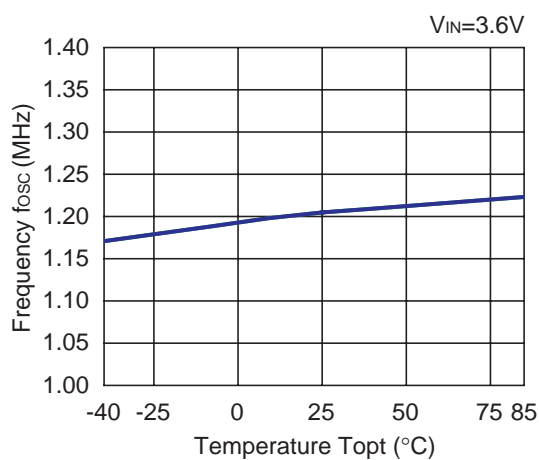

12) Maxduty vs. Temperature

R1200x

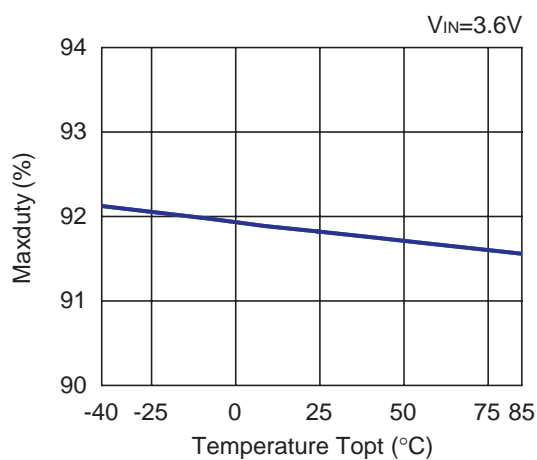

13) OVP Detect / Released Voltage vs. Temperature

R1200x001x



14) Soft-start Time vs. Temperature

R1200x



15) VOUT Discharge Current vs. Temperature

R1200x



16) Lx Limit Current vs. Temperature
R1200x

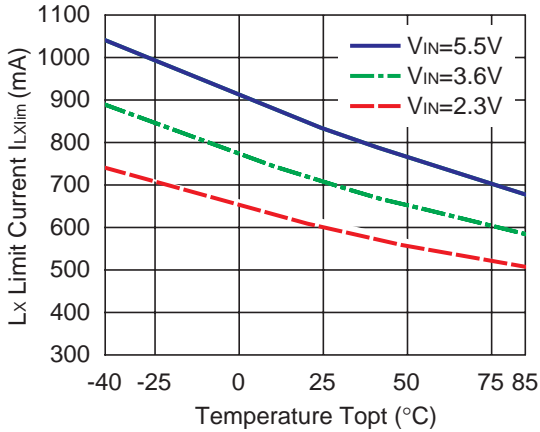

17) Switch ON Resistance vs. Temperature
R1200x

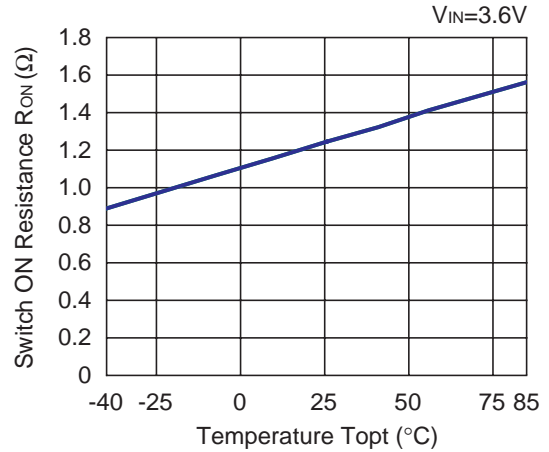

18) Load Transient Response (VIN=3.6V, IOUT=5mA↔25mA, tr=tf=0.5μs)
R1200x

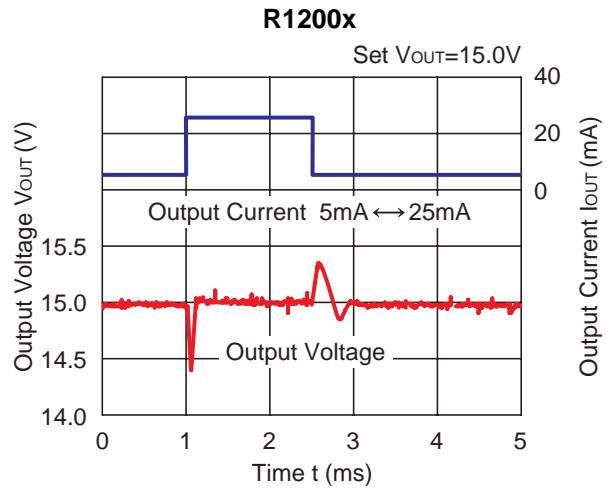
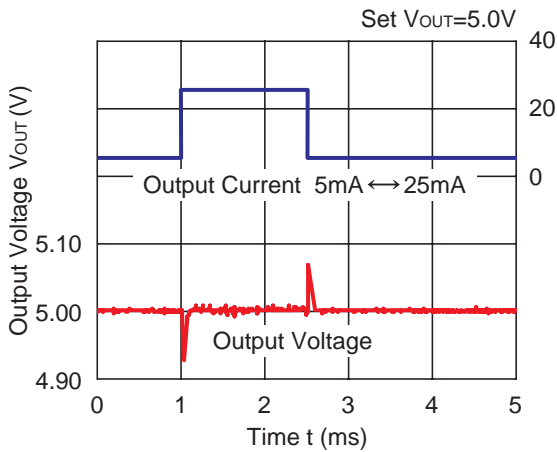

19) Start-up Waveform (VIN=3.6V, IOUT=20mA)
R1200x001A

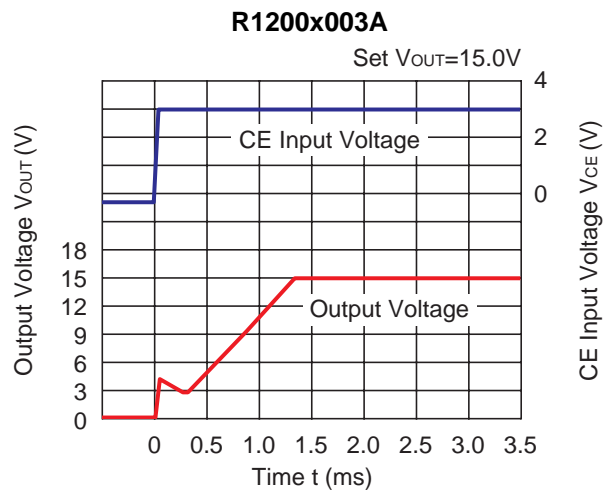

R1200x

20) Shut-down Waveform ($V_{IN}=3.6V$, $I_{OUT}=20mA$)

R1200x001A



R1200x003A



21) OVP Waveform ($V_{FB}=0V$)

R1200x001A





1. The products and the product specifications described in this document are subject to change or discontinuation of production without notice for reasons such as improvement. Therefore, before deciding to use the products, please refer to Ricoh sales representatives for the latest information thereon.
2. The materials in this document may not be copied or otherwise reproduced in whole or in part without prior written consent of Ricoh.
3. Please be sure to take any necessary formalities under relevant laws or regulations before exporting or otherwise taking out of your country the products or the technical information described herein.
4. The technical information described in this document shows typical characteristics of and example application circuits for the products. The release of such information is not to be construed as a warranty of or a grant of license under Ricoh's or any third party's intellectual property rights or any other rights.
5. The products listed in this document are intended and designed for use as general electronic components in standard applications (office equipment, telecommunication equipment, measuring instruments, consumer electronic products, amusement equipment etc.). Those customers intending to use a product in an application requiring extreme quality and reliability, for example, in a highly specific application where the failure or misoperation of the product could result in human injury or death (aircraft, spacevehicle, nuclear reactor control system, traffic control system, automotive and transportation equipment, combustion equipment, safety devices, life support system etc.) should first contact us.
6. We are making our continuous effort to improve the quality and reliability of our products, but semiconductor products are likely to fail with certain probability. In order to prevent any injury to persons or damages to property resulting from such failure, customers should be careful enough to incorporate safety measures in their design, such as redundancy feature, firecontainment feature and fail-safe feature. We do not assume any liability or responsibility for any loss or damage arising from misuse or inappropriate use of the products.
7. Anti-radiation design is not implemented in the products described in this document.
8. Please contact Ricoh sales representatives should you have any questions or comments concerning the products or the technical information.



For the conservation of the global environment, Ricoh is advancing the decrease of the negative environmental impact material.
After Apr. 1, 2006, we will ship out the lead free products only. Thus, all products that will be shipped from now on comply with RoHS Directive.
Basically after Apr. 1, 2012, we will ship out the Power Management ICs of the Halogen Free products only. (Ricoh Halogen Free products are also Antimony Free.)

RICOH RICOH COMPANY, LTD. Electronic Devices Company

<http://www.ricoh.com/LSI/>

RICOH COMPANY, LTD.

Electronic Devices Company

● Higashi-Shinagawa Office (International Sales)

3-32-3, Higashi-Shinagawa, Shinagawa-ku, Tokyo 140-8655, Japan
Phone: +81-3-5479-2857 Fax: +81-3-5479-0502

RICOH EUROPE (NETHERLANDS) B.V.

● Semiconductor Support Centre

"Nieuw Kronenburg" Prof. W.H. Keesomlaan 1, 1183 DJ, Amstelveen, The Netherlands
P.O.Box 114, 1180 AC Amstelveen
Phone: +31-20-5474-309 Fax: +31-20-5474-791

RICOH ELECTRONIC DEVICES KOREA Co., Ltd.

11 floor, Haesung 1 building, 942, Daechidong, Gangnamgu, Seoul, Korea
Phone: +82-2-2135-5700 Fax: +82-2-2135-5705

RICOH ELECTRONIC DEVICES SHANGHAI Co., Ltd.

Room403, No.2 Building, 690#Bi Bo Road, Pu Dong New district, Shanghai 201203,
People's Republic of China
Phone: +86-21-5027-3200 Fax: +86-21-5027-3299

RICOH COMPANY, LTD.

Electronic Devices Company

● Taipei office

Room109, 10F-1, No.51, Hengyang Rd., Taipei City, Taiwan (R.O.C.)
Phone: +886-2-2313-1621/1622 Fax: +886-2-2313-1623

Mouser Electronics

Authorized Distributor

Click to View Pricing, Inventory, Delivery & Lifecycle Information:

[Ricoch Electronics:](#)

[R1200N003A-TR-FE](#) [R1200K003A-TR](#) [R1200N001A-TR-FE](#) [R1200N002A-TR-FE](#) [R1200K001A-TR](#)

Данный компонент на территории Российской Федерации

Вы можете приобрести в компании MosChip.

Для оперативного оформления запроса Вам необходимо перейти по данной ссылке:

<http://moschip.ru/get-element>

Вы можете разместить у нас заказ для любого Вашего проекта, будь то серийное производство или разработка единичного прибора.

В нашем ассортименте представлены ведущие мировые производители активных и пассивных электронных компонентов.

Нашей специализацией является поставка электронной компонентной базы двойного назначения, продукции таких производителей как XILINX, Intel (ex.ALTERA), Vicor, Microchip, Texas Instruments, Analog Devices, Mini-Circuits, Amphenol, Glenair.

Сотрудничество с глобальными дистрибьюторами электронных компонентов, предоставляет возможность заказывать и получать с международных складов практически любой перечень компонентов в оптимальные для Вас сроки.

На всех этапах разработки и производства наши партнеры могут получить квалифицированную поддержку опытных инженеров.

Система менеджмента качества компании отвечает требованиям в соответствии с ГОСТ Р ИСО 9001, ГОСТ РВ 0015-002 и ЭС РД 009

Офис по работе с юридическими лицами:

105318, г.Москва, ул.Щербаковская д.3, офис 1107, 1118, ДЦ «Щербаковский»

Телефон: +7 495 668-12-70 (многоканальный)

Факс: +7 495 668-12-70 (доб.304)

E-mail: info@moschip.ru

Skype отдела продаж:

moschip.ru

moschip.ru_4

moschip.ru_6

moschip.ru_9