



Thyristor \ Diode Module

$V_{RRM} = 2 \times 1600 \text{ V}$

$I_{TAV} = 700 \text{ A}$

$V_T = 1.11 \text{ V}$

Phase leg

Part number

MCMA700PD1600CB

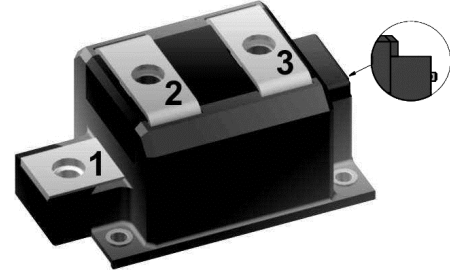

Backside: isolated

E72873



Features / Advantages:

- Thyristor for line frequency
- Planar passivated chip
- Long-term stability
- Direct Copper Bonded Al₂O₃-ceramic

Applications:

- Line rectifying 50/60 Hz
- Softstart AC motor control
- DC Motor control
- Power converter
- AC power control
- Lighting and temperature control

Package: ComPack

- Isolation Voltage: 4800 V~
- Industry standard outline
- RoHS compliant
- Soldering pins for PCB mounting
- Base plate: Copper internally DCB isolated
- Advanced power cycling
- Phase Change Material available

Disclaimer Notice

Information furnished is believed to be accurate and reliable. However, users should independently evaluate the suitability of and test each product selected for their own applications. Littelfuse products are not designed for, and may not be used in, all applications. Read complete Disclaimer Notice at www.littelfuse.com/disclaimer-electronics.



Rectifier			Ratings			
Symbol	Definition	Conditions	min.	typ.	max.	Unit
$V_{RSM/DSM}$	max. non-repetitive reverse/forward blocking voltage	$T_{VJ} = 25^{\circ}C$			1700	V
$V_{RRM/DRM}$	max. repetitive reverse/forward blocking voltage	$T_{VJ} = 25^{\circ}C$			1600	V
I_{RD}	reverse current, drain current	$V_{R/D} = 1600 V$	$T_{VJ} = 25^{\circ}C$		2	mA
		$V_{R/D} = 1600 V$	$T_{VJ} = 125^{\circ}C$		40	mA
V_T	forward voltage drop	$I_T = 700 A$	$T_{VJ} = 25^{\circ}C$		1.16	V
		$I_T = 1400 A$			1.41	V
		$I_T = 700 A$	$T_{VJ} = 125^{\circ}C$		1.11	V
		$I_T = 1400 A$			1.41	V
I_{TAV}	average forward current	$T_C = 85^{\circ}C$ 180° sine	$T_{VJ} = 140^{\circ}C$		700	A
V_{T0}	threshold voltage	} for power loss calculation only	$T_{VJ} = 140^{\circ}C$		0.82	V
r_T	slope resistance				0.4	mΩ
R_{thJC}	thermal resistance junction to case				0.05	K/W
R_{thCH}	thermal resistance case to heatsink			0.02		K/W
P_{tot}	total power dissipation		$T_C = 25^{\circ}C$		2300	W
I_{TSM}	max. forward surge current	$t = 10 ms; (50 Hz), sine$	$T_{VJ} = 45^{\circ}C$		19.0	kA
		$t = 8,3 ms; (60 Hz), sine$	$V_R = 0 V$		20.5	kA
		$t = 10 ms; (50 Hz), sine$	$T_{VJ} = 140^{\circ}C$		16.2	kA
		$t = 8,3 ms; (60 Hz), sine$	$V_R = 0 V$		17.4	kA
I^2t	value for fusing	$t = 10 ms; (50 Hz), sine$	$T_{VJ} = 45^{\circ}C$		1.81	MA ² s
		$t = 8,3 ms; (60 Hz), sine$	$V_R = 0 V$		1.75	MA ² s
		$t = 10 ms; (50 Hz), sine$	$T_{VJ} = 140^{\circ}C$		1.30	MA ² s
		$t = 8,3 ms; (60 Hz), sine$	$V_R = 0 V$		1.27	MA ² s
C_J	junction capacitance	$V_R = 400 V f = 1 MHz$	$T_{VJ} = 25^{\circ}C$		876	pF
P_{GM}	max. gate power dissipation	$t_p = 30 \mu s$	$T_C = 140^{\circ}C$		240	W
		$t_p = 300 \mu s$			120	W
P_{GAV}	average gate power dissipation				40	W
$(di/dt)_{cr}$	critical rate of rise of current	$T_{VJ} = 140^{\circ}C; f = 50 Hz$ repetitive, $I_T = 2100 A$			100	A/μs
		$t_p = 200 \mu s; di_G/dt = 1 A/\mu s;$ $I_G = 1 A; V = 2/3 V_{DRM}$ non-repet., $I_T = 700 A$			500	A/μs
$(dv/dt)_{cr}$	critical rate of rise of voltage	$V = 2/3 V_{DRM}$	$T_{VJ} = 140^{\circ}C$		1000	V/μs
		$R_{GK} = \infty$; method 1 (linear voltage rise)				
V_{GT}	gate trigger voltage	$V_D = 6 V$	$T_{VJ} = 25^{\circ}C$		2	V
			$T_{VJ} = -40^{\circ}C$		3	V
I_{GT}	gate trigger current	$V_D = 6 V$	$T_{VJ} = 25^{\circ}C$		300	mA
			$T_{VJ} = -40^{\circ}C$		400	mA
V_{GD}	gate non-trigger voltage	$V_D = 2/3 V_{DRM}$	$T_{VJ} = 140^{\circ}C$		0.25	V
I_{GD}	gate non-trigger current				10	mA
I_L	latching current	$t_p = 30 \mu s$	$T_{VJ} = 25^{\circ}C$		400	mA
		$I_G = 1 A; di_G/dt = 1 A/\mu s$				
I_H	holding current	$V_D = 6 V R_{GK} = \infty$	$T_{VJ} = 25^{\circ}C$		300	mA
t_{gd}	gate controlled delay time	$V_D = 1/2 V_{DRM}$	$T_{VJ} = 25^{\circ}C$		2	μs
		$I_G = 1 A; di_G/dt = 1 A/\mu s$				
t_q	turn-off time	$V_R = 100 V; I_T = 700 A; V = 2/3 V_{DRM}$ $di/dt = 10 A/\mu s dv/dt = 50 V/\mu s t_p = 200 \mu s$	$T_{VJ} = 125^{\circ}C$		350	μs

Package ComPack		Ratings				
Symbol	Definition	Conditions	min.	typ.	max.	Unit
I_{RMS}	RMS current	per terminal			1200	A
T_{VJ}	virtual junction temperature		-40		140	°C
T_{op}	operation temperature		-40		125	°C
T_{stg}	storage temperature		-40		125	°C
Weight				500		g
M_D	mounting torque		3		5	Nm
M_T	terminal torque		12		14	Nm
$d_{Spp/App}$	creepage distance on surface striking distance through air	terminal to terminal	21.0			mm
$d_{Spb/Apb}$		terminal to backside	18.0			mm
V_{ISOL}	isolation voltage	t = 1 second	4800			V
		t = 1 minute	4000			V

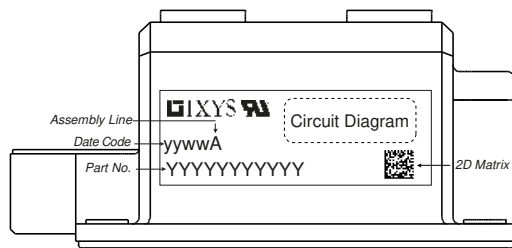
Part description

- M = Module
- C = Thyristor (SCR)
- M = Thyristor
- A = (up to 1800V)
- 700 = Current Rating [A]
- PD = Phase leg
- 1600 = Reverse Voltage [V]
- CB = ComPack
- = Hyphen
- PC = Phase Change Material

Ordering	Ordering Number	Marking on Product	Delivery Mode	Quantity	Code No.
Standard	MCMA700PD1600CB	MCMA700PD1600CB	Box	3	513842
Alternative	MCMA700PD1600CB-PC	MCMA700PD1600CB	Box	3	518554

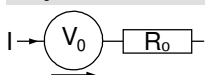
Equivalent Circuits for Simulation
** on die level*
 $T_{VJ} = 140^{\circ}\text{C}$

Thyristor

$V_{0\ max}$	threshold voltage	0.82	V
$R_{0\ max}$	slope resistance *	0.21	mΩ

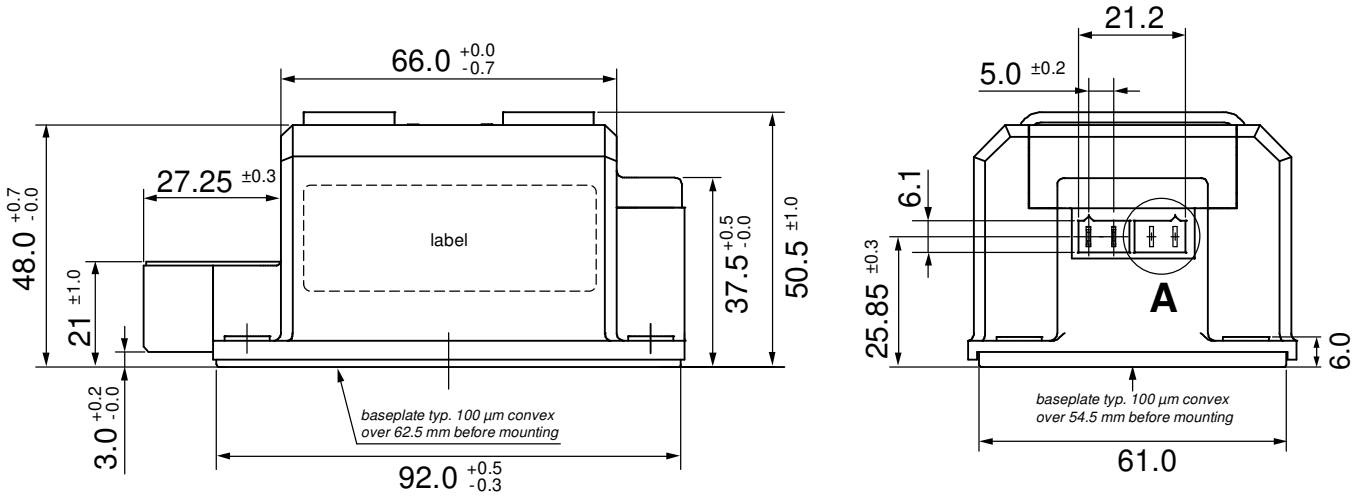

Outlines ComPack



Optional accessories for modules
Keyed gate/cathode twin plug with
wire length = 350 mm, gate = white, cathode = red
Type ZY 180L (L = Left for pin pair 4/5) UL 758, style 3751

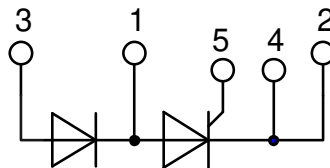
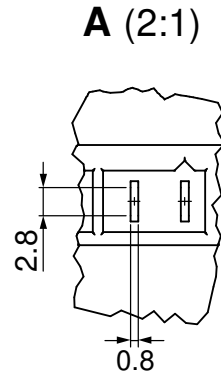
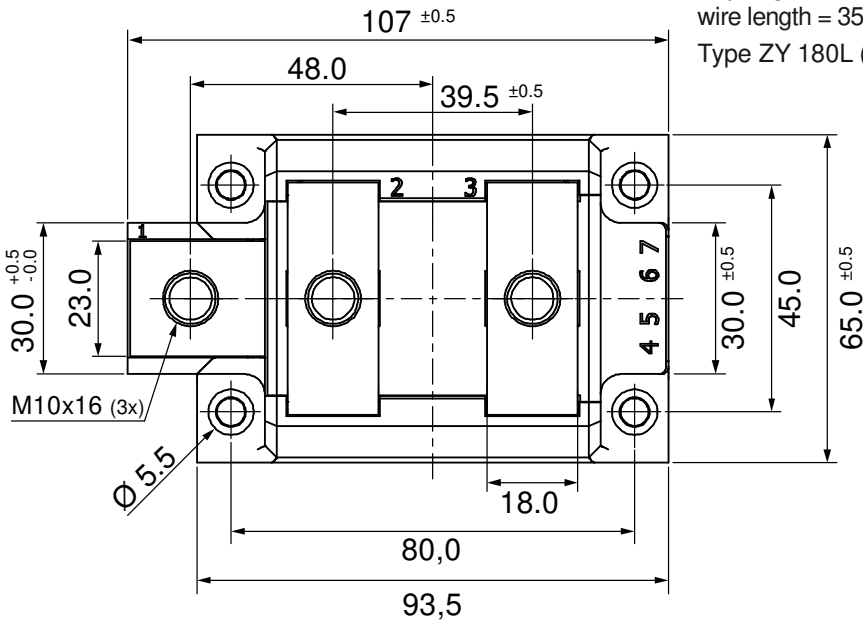

Thyristor

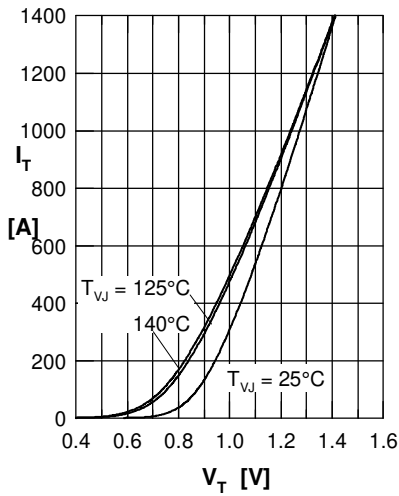

Fig. 1 Forward characteristics

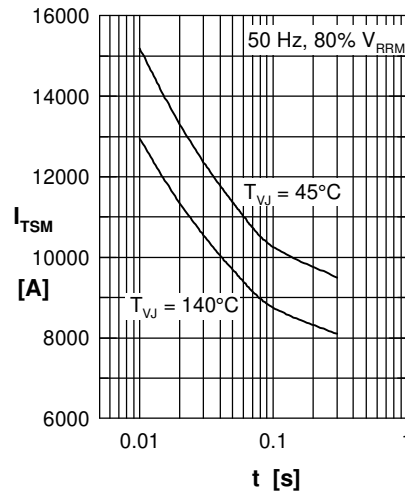

Fig. 2 Surge overload current
 I_{TSM} : crest value, t : duration

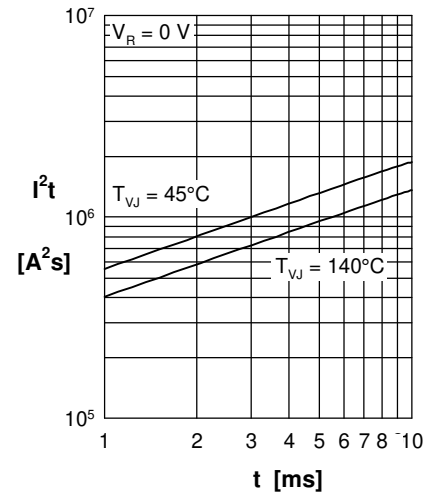

Fig. 3 I^2t versus time (1-10 s)

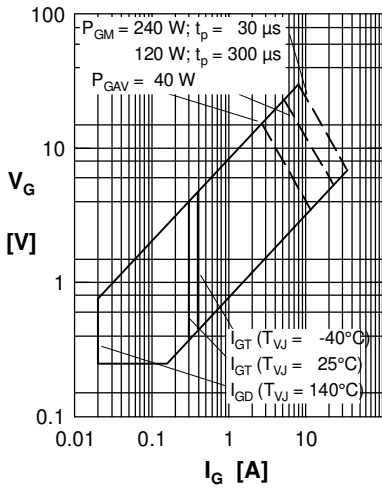

Fig. 4 Gate voltage & gate current

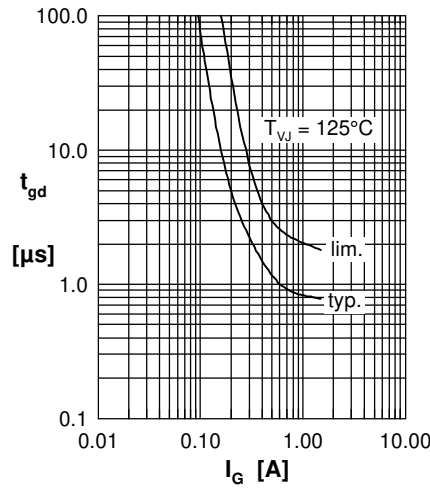

Fig. 5 Gate controlled delay time t_{gd}

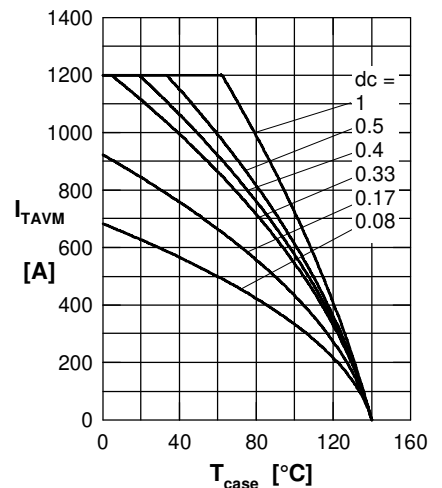

Fig. 6 Max. forward current at case temperature

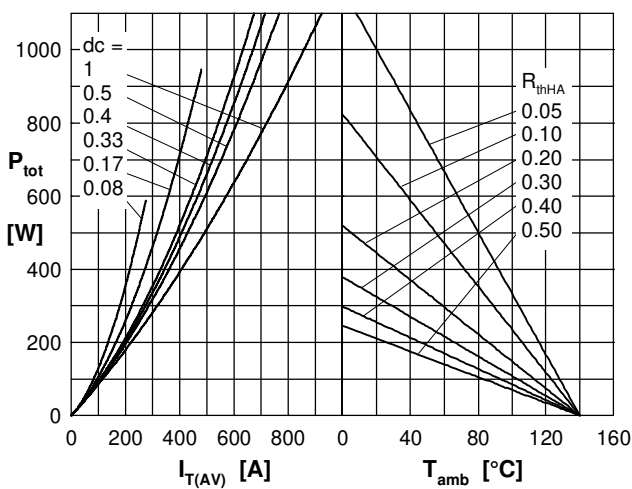

Fig. 7a Power dissipation versus direct output current
 Fig. 7b and ambient temperature

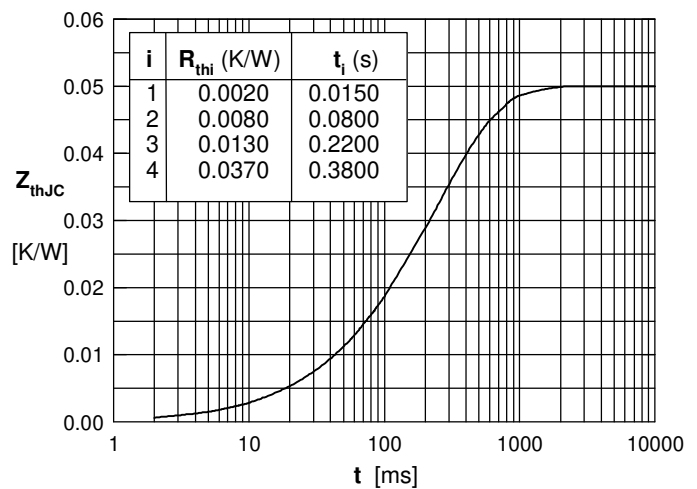

Fig. 8 Transient thermal impedance junction to case

Данный компонент на территории Российской Федерации

Вы можете приобрести в компании MosChip.

Для оперативного оформления запроса Вам необходимо перейти по данной ссылке:

<http://moschip.ru/get-element>

Вы можете разместить у нас заказ для любого Вашего проекта, будь то серийное производство или разработка единичного прибора.

В нашем ассортименте представлены ведущие мировые производители активных и пассивных электронных компонентов.

Нашей специализацией является поставка электронной компонентной базы двойного назначения, продукции таких производителей как XILINX, Intel (ex.ALTERA), Vicor, Microchip, Texas Instruments, Analog Devices, Mini-Circuits, Amphenol, Glenair.

Сотрудничество с глобальными дистрибьюторами электронных компонентов, предоставляет возможность заказывать и получать с международных складов практически любой перечень компонентов в оптимальные для Вас сроки.

На всех этапах разработки и производства наши партнеры могут получить квалифицированную поддержку опытных инженеров.

Система менеджмента качества компании отвечает требованиям в соответствии с ГОСТ Р ИСО 9001, ГОСТ РВ 0015-002 и ЭС РД 009

Офис по работе с юридическими лицами:

105318, г.Москва, ул.Щербаковская д.3, офис 1107, 1118, ДЦ «Щербаковский»

Телефон: +7 495 668-12-70 (многоканальный)

Факс: +7 495 668-12-70 (доб.304)

E-mail: info@moschip.ru

Skype отдела продаж:

moschip.ru

moschip.ru_4

moschip.ru_6

moschip.ru_9