

## Interactive Catalog Supplements Catalog PDFs

If you need detailed product information, or help choosing the right product for your application, see our [Interactive Catalog](#). Use the [Interactive Catalog](#) to access the most complete and up-to-date information available.

The [Interactive Catalog](#) provides an extensive collection of product specifications, application data, and technical literature that can be searched based on criteria you select.

This PDF catalog information was published in November 2000.



Sensing and Control  
[Interactive Catalog...](#)

**Click this icon to try  
the Interactive Catalog.**

---

### Sensing and Control

Honeywell Inc.

11 West Spring Street

Freeport, IL 61032

# Manual Switches

## Miniature Manual Line



### FEATURES

- Breadth of line offers complete selection of pushbuttons, rockers, and indicators to accommodate different functions and promote operator efficiency.
- Printed wiring board (PWB) or panel mounted switches, plus multi-unit strip mounting, and single level termination for cost-effective installation.
- Tactile feedback imparts a definite feel of switching action.
- Coordinated appearance enhances panel harmony.
- Illumination by long-life LEDs and incandescent lamps—for lighted display versatility.
- Solid state, electronic control and power duty switching—for electrical versatility.
- Temperature range:  $-18^{\circ}$  to  $65^{\circ}\text{C}$  ( $0^{\circ}$  to  $149^{\circ}\text{F}$ ).

### DESIGN FREEDOM

Rocker switches are available in the MICRO SWITCH MML Miniature Manual Line. They complement AML pushbuttons and indicators, providing you flexibility and design freedom to answer all your miniature manual control requirements. You can choose the actuator option that matches the switch function and natural habit pattern reflex of the operator. You no longer need to compromise quality, appearance, or human factors considerations, because of size constraints.

The MML pushbutton and indicator offering has also been expanded to include new square forms which are small enough to fit in the tightest places.

### MOUNTING FLEXIBILITY

Printed wiring board (PWB) mounted switches can be arranged in individual panel openings or multi-unit strips, in a common panel cutout. Optional support brackets provide added rigidity for stand-alone PWB mounted devices. Units with bezels and mounting clips can be snap-in mounted from the panel front.

Single level PWB or solder/quick-connect termination throughout makes wiring faster, easier, and more economical. Housings are designed to accommodate washing, before and after wave soldering, to help prevent contamination during printed wiring board installation.

### LIGHTED DISPLAY OPTIONS

Pushbuttons and indicators can be full-face illuminated by LEDs or incandescent lamps for high visibility of colors and legends. Inherently rugged, long-life LEDs reduce service and maintenance costs. Also, their low drive and inrush current (30 mA or less) reduces costs of drive circuitry.

Rockers can be furnished with colored lenses for illumination by LEDs or incandescent lamps.

### CONTROL VERSATILITY

Solid state pushbutton switches with Hall effect integrated circuits interface directly with microprocessors and other logic level devices. Time-proven for billions of cycles, Hall effect ICs provide the ultimate in reliability.

Electronic control pushbutton or rocker switches, with gold or silver contacts, handle up to 1 amp; power duty switches, up to 6 amps.

# Manual Switches

## Miniature Manual Line

### MML ENHANCES PANEL HARMONY

The attractive clean line design of the total MML offering is coordinated to work in harmony and enhance the visual qualities of your product. MML will help make a good first impression with your customers by blending with other panel components. And also work hard over the long run to maintain operator satisfaction.

### HOW TO ORDER

To specify MML catalog listings, refer to the order guides. They are based on a modular cataloging system which gives you the flexibility to choose the combination of feature options that best answers the requirements of your application.

### ORDER GUIDES

|  |       |
|--|-------|
| <b>Solid State Switches</b>                            |       |
| MML11 Pushbutton Switches .....                        | 58    |
| <b>Electronic Control Switches</b>                     |       |
| MML21 Pushbutton Switches .....                        | 60    |
| MML24 Rocker Switches .....                            | 62    |
| <b>Power Duty Switches</b>                             |       |
| MML31 Pushbutton Switches .....                        | 64    |
| <b>Indicators</b>                                      |       |
| MML41 Indicators/LED or Incandescent Display .....     | 66    |
| MML46 Indicators/LED or Incandescent Display .....     | 66    |
| <b>Lenses and Buttons</b>                              |       |
| MML51 Lenses/Incandescent or Non-lighted Display ..... | 68    |
| MML52 Lenses/LED or Neon Display .....                 | 68    |
| <b>Mounting Hardware</b>                               |       |
| MML61 Strip Mounting Frames .....                      | 71    |
| MML72/73 Bezels and Mounting Clips .....               | 72    |
| MML74 PWB Mount Support Brackets .....                 | 72    |
| <b>LEDs, Lamps, Receptacles</b>                        |       |
| MML92/93 LED's/Receptacles .....                       | 73/76 |
| MML91/93 Incandescent Lamps/Receptacles .....          | 75/76 |



**MML medical application.** Intranavenous fluid flow controller automatically dispenses fluids for medications, therapy, and nutrition.



**MML communications application.** Mobile radio control keeps businesses in touch with employees on the road.

Manuals

# Manual Switches

## Miniature Manual Line

### MML CHARACTERISTICS

|                               | MML 10 Series | MML 20 Series | MML 30 Series | MML 40 Series |
|-------------------------------|---------------|---------------|---------------|---------------|
| <b>Mechanical Lifetime*</b>   |               |               |               | N/A           |
| Pushbuttons–Momentary         | 1,000,000     | 250,000       | 100,000       | ---           |
| Pushbuttons–Alternate         | 100,000       | 100,000       | 100,000       | ---           |
| Rockers                       | 100,000       | 250,000       | 100,000       | ---           |
| <b>Electrical Lifetime***</b> |               |               |               | N/A           |
| Pushbuttons–Momentary         | 1,000,000     | 25,000        | 25,000        | ---           |
| Pushbuttons–Alternate         | 100,000       | 25,000        | 25,000        | ---           |
| Rockers                       | 100,000       | 25,000        | 25,000        | ---           |
| <b>Agency Ratings</b>         |               |               |               |               |
| UL                            | File E53576   | File E12252   | File E12252   | File E58932   |
| CSA                           | File L R4442  | File LR4442   | File LR4442   | File LR4442   |

\*95% Survival

\*\* Lifetime at Full Rated Load

### MML ELECTRICAL DATA

#### MML10 SERIES

|                                   |   |  |   |
|-----------------------------------|---|--|---|
| <b>Electrical Characteristics</b> | Integrated Circuit Function               | 5-24 VDC Sinking   |   |
|                                   | Supply Current (Max.)                     | 7 mA (Released)<br>8 mA (Operated no load)                                 |   |
|                                   | Output Voltage (Operated)                 | 0.3 Volt (Sinking 10 mA)   |   |
|                                   | Output Leakage Current<br>Max. (Released) | 5.0 $\mu$ A  |   |
|                                   | Switching Time Max.                       |  |   |
|                                   | Rise 10% to 90%                           | 1.5 $\mu$ sec (Sinking 10 mA)  |   |
|                                   | Fall 90% to 10%                           | 0.5 $\mu$ sec (Sinking 10 mA)  |   |
|                                   | Rated Output Current                      | 10 mA Sinking  |   |
|                                   | <b>Absolute Maximum Ratings</b>           | Supply Voltage ( $V_s$ )   | -28 to +28 VDC                                      |
|                                   |   | Voltage Externally Applied<br>to Output                                    | -0.5 Volt min.<br>+28 Volts max.<br>(Off condition) |
| Loads to Output                   |   | 20 mA (Sinking)  |   |
| Storage Temperature               |   | -40° to +85°C<br>(-40° to +185°F)  |   |
| Operating Temperature             |   | -18° to +65°C<br>(0° to +149°F)<br>and supply voltage of 4.5<br>to 5.5 VDC |   |

As with all solid state components, performance can be expected to deteriorate as rating limits are approached; however, they will not be damaged unless the limits are exceeded.

# Manual Switches

## Miniature Manual Line

**MML20 SERIES**

|  |   |
|--|---|
| <b>Electrical Rating</b><br>(silver contacts)    | <b>Standard buttons</b><br>Up to 1 amp, 125 VAC   |
|  | <b>1 piece plunger/lens cap buttons:</b><br>Black—Up to 1 amp, 125 VAC<br>All others—Up to 0.5 amp, 125 VAC |
| <b>Electrical Rating</b><br><b>Gold Contacts</b> | <b>All button styles:</b><br>Up to 0.25 amp, 30 VDC<br>UL rating—0.10 amp, 30 VDC                           |
|  | One pole Form C<br>        |

**MML30 SERIES**

**MML31:**

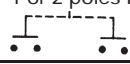
|                            |   |
|----------------------------|---|
| <b>Electrical Rating</b>   | 6A @ 125 VAC, 250 VAC; 2A @ 30 VDC;   |
| <b>Silver Contacts</b>     | 1A @ 125 VDC "L"; 1/10 hp @ 125 VAC   |
| <b>Contact Arrangement</b> | 1 or 2 poles Form X<br> |

Manuals

# Manual Switches

## Solid State Pushbutton

MML11 Series

LED, INCANDESCENT, OR NON-LIGHTED DISPLAY



PWB Mount

**FEATURES**

- Hall effect reliability
- Provides low voltage signals that interface with nearly all DC logic
- Accepts one LED or incandescent lamp
- Printed wiring board mounting
- UL recognized, CSA certified
- Bezels and mounting clips, LEDs and legended lenses can be furnished installed or ordered separately

**Example: MML11KK3AAKRSR**

Furnished with black bezel; mounting clips (long sides); red LED, and red lens installed.

MML11 ORDER GUIDE

Catalog listing codes for switch, less assembled display options

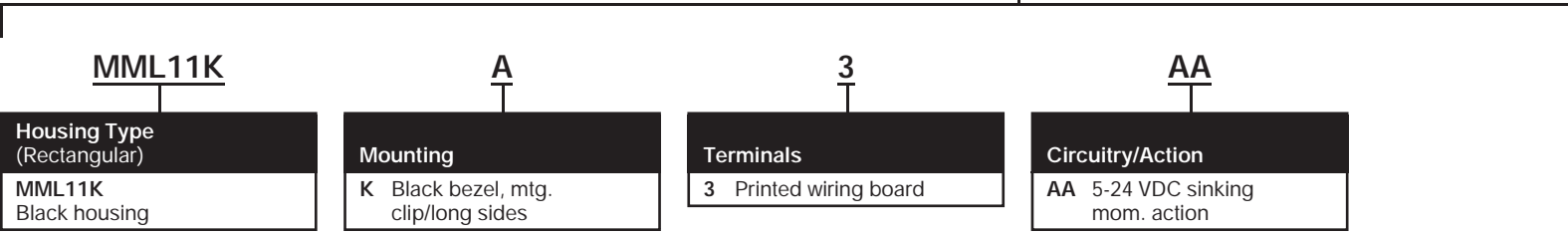

# Manual Switches

## Solid State Pushbutton Switches

|                           |             |
|---------------------------|-------------|
| Electrical Data           | page 56     |
| Strip and matrix mounting | page 71     |
| Mounting dimensions       | page 79     |
| PWB pin locations         | page 79     |
| LED/receptacle            | pages 73/74 |
| Lamp/LED/Lens             | pages 75/76 |

**Current Sinking Output**  
 A permanent magnet plunger moves adjacent to the Hall effect integrated circuit to give a digital, current sinking (normally high and normally low) output.

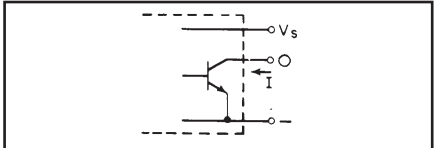

Order display options assembled to switch by adding codes below

|                |   |  |  |
|----------------|---|--|--|
| <b>K</b>       | <b>RS</b>   | <b>DR</b>  | Leave this space blank,<br>[ ]   |
| <b>Plunger</b> | <b>LED<br/>(Stanley Type)</b>   | <b>Lens</b>  | <b>Legend</b>  |
| K Black        | XX No LED<br>RS Red*<br>YS Yellow*<br>GS Green*<br>* Permanently installed. | For LED display:<br>DR Red<br>DY Yellow<br>DG Green<br><br>For incandescent or non-lighted display:<br>LR Red<br>LY Yellow<br>LG Green<br>LW White<br>LK Black | 20 With Legend<br><br>Use Legend Order Sheet FO-74024 to cover each catalog listing (see page 69). |

**CUSTOMER INSTALLATION:**

**LED**

- Order LED and receptacle, page 73.
- Installation instructions, page 74/76.

**Incandescent Lamp**

- Order lamp/PWB receptacle or lamp/solder receptacle, page 75.
- Installation instructions, page 76.

Manuals

# Manual Switches

## Electronic Control Pushbutton

MML21 Series

LED, INCANDESCENT, OR NON-LIGHTED DISPLAY

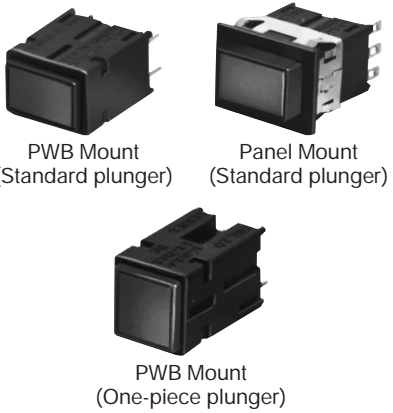

- FEATURES**
- Silver or gold contacts
  - Choice of rectangular or square housings
  - Accepts one LED or incandescent lamp
  - Printed wiring board or snap-in panel mounting
  - Bezels and mounting clips, LEDs and legended lenses can be furnished installed or ordered separately
  - UL recognized, CSA certified

**Example: MML21KK3AAK**  
 Electronic control pushbutton switch with standard plunger; rectangular housing (black); bezel (black); mounting clips on long sides, PWB terminals; 1-pole, momentary action, silver contacts, black plunger.

**Example: MML21KK3AAKRSDR**  
 As above, except furnished with red LED and red lens installed.

**MML21KK3AAHRSXX20** as above, leg-ended.

Catalog listing codes for switch, less assembled display options

### MML21 STANDARD PLUNGER SWITCHES ORDER GUIDE

| MML21K  |  | K  |  | 3                                  |  | AA   |   |
|---|--|--|--|------------------------------------|--|--|---|
| Housing Type  |  | Mounting   |  | Terminals                          |  | Circuitry/Action (Each pole is double throw)   |   |
|   |  | Rectangular  | Square   |                                    |  | Rectangular  | Square  |
| MML21K<br>Rectangular Black Housing<br>MML21H<br>Square Black Housing |  | A No bezel (PWB mounting)<br>K Black bezel, mtg. clip/long sides | A No bezel (PWB mounting)<br>R Black bezel & mtg. clip | 3 Printed Wiring Board<br>2 Solder |  | <b>Silver Contacts:</b><br>AA 1 pole, mom. action<br>AB 1 pole, alt. action<br>AC 2 pole, mom. action<br>AD 2 pole, alt. action<br><b>Gold Contacts:</b><br>BA 1 pole, mom. action<br>BB 1 pole, alt. action<br>BC 2 pole, mom. action<br>BD 2 pole, alt. action | <b>Silver contacts:</b><br>AA 1-pole, mom. action<br>AB 1-pole, alt. action<br><br><b>Gold contacts</b><br>BA 1-pole, mom. action<br>BB 1-pole, alt. action |

### MML21 ONE PIECE LENS/PLUNGER SWITCHES ORDER GUIDE

Catalog listing codes for switch, less assembled display options

| MML21H  |  | K  |  | 3                                  |  | AA   |   |
|---|--|--|--|------------------------------------|--|--|---|
| Housing Type  |  | Mounting   |  | Terminals                          |  | Circuitry/Action (Each pole is double throw)   |   |
|   |  | Rectangular  | Square   |                                    |  | Rectangular  | Square  |
| MML21K<br>Rectangular Black Housing<br>MML21H<br>Square Black Housing |  | A No bezel (PWB mounting)<br>K Black bezel, mtg. clip/long sides | A No bezel (PWB Mounting)<br>R Black bezel & mtg. clip | 3 Printed Wiring Board<br>2 Solder |  | <b>Silver Contacts:</b><br>AA 1 pole, mom. action<br>AB 1 pole, alt. action<br>AC 2 pole, mom. action<br>AD 2 pole, alt. action<br><b>Gold Contacts:</b><br>BA 1 pole, mom. action<br>BB 1 pole, alt. action<br>BC 2 pole, mom. action<br>BD 2 pole, alt. action | <b>Silver contacts:</b><br>AA 1-pole, mom. action<br>AB 1-pole, alt. action<br><br><b>Gold contacts</b><br>BA 1-pole, mom. action<br>BB 1-pole, alt. action |



# Manual Switches

## Electronic Control Pushbutton Switches

|                           |         |
|---------------------------|---------|
| Electrical Data           | page 57 |
| Bezels                    | page 72 |
| Strip and matrix mounting | page 71 |
| PWB pin locations         | page 79 |

Order display options assembled to switch by adding codes below<sup>3</sup>

|   |   |       |          |       |  |           |                     |           |                  |           |                     |           |                    |   |           |         |                 |  |           |     |           |        |           |       |                                       |  |           |     |           |        |           |       |           |       |           |       |   |           |   |
|---|---|-------|----------|-------|--|-----------|---------------------|-----------|------------------|-----------|---------------------|-----------|--------------------|---|-----------|---------|-----------------|--|-----------|-----|-----------|--------|-----------|-------|---------------------------------------|--|-----------|-----|-----------|--------|-----------|-------|-----------|-------|-----------|-------|---|-----------|---|
| <p><b>K</b></p> <p><b>Plunger Type</b></p> <table border="1" style="width: 100%;"> <tr> <td><b>K</b></td> <td>Black</td> </tr> <tr> <td><b>W</b></td> <td>White</td> </tr> </table> | <b>K</b>                                      | Black | <b>W</b> | White | <p><b>RS</b></p> <p><b>LED*</b></p> <table border="1" style="width: 100%;"> <tr> <td><b>XX</b></td> <td>No Led<sup>4</sup></td> </tr> <tr> <td><b>RS</b></td> <td>Red<sup>5</sup></td> </tr> <tr> <td><b>YS</b></td> <td>Yellow<sup>5</sup></td> </tr> <tr> <td><b>GS</b></td> <td>Green<sup>5</sup></td> </tr> </table> | <b>XX</b> | No Led <sup>4</sup> | <b>RS</b> | Red <sup>5</sup> | <b>YS</b> | Yellow <sup>5</sup> | <b>GS</b> | Green <sup>5</sup> | <p><b>DR</b></p> <p><b>Lens</b></p> <table border="1" style="width: 100%;"> <tr> <td><b>XX</b></td> <td>No Lens</td> </tr> <tr> <td colspan="2">For LED Display</td> </tr> <tr> <td><b>DR</b></td> <td>Red</td> </tr> <tr> <td><b>DY</b></td> <td>Yellow</td> </tr> <tr> <td><b>DG</b></td> <td>Green</td> </tr> <tr> <td colspan="2">For Incandescent or Unlighted Display</td> </tr> <tr> <td><b>LR</b></td> <td>Red</td> </tr> <tr> <td><b>LY</b></td> <td>Yellow</td> </tr> <tr> <td><b>LG</b></td> <td>Green</td> </tr> <tr> <td><b>LW</b></td> <td>White</td> </tr> <tr> <td><b>LK</b></td> <td>Black</td> </tr> </table> | <b>XX</b> | No Lens | For LED Display |  | <b>DR</b> | Red | <b>DY</b> | Yellow | <b>DG</b> | Green | For Incandescent or Unlighted Display |  | <b>LR</b> | Red | <b>LY</b> | Yellow | <b>LG</b> | Green | <b>LW</b> | White | <b>LK</b> | Black | <p><b>Legend</b></p> <table border="1" style="width: 100%;"> <tr> <td><b>20</b></td> <td>With Legend (Leave Blank if no legend needed)</td> </tr> </table> <p>Use Legend Order Sheet FO-74024 to cover each catalog listing. (See page 69.)</p> | <b>20</b> | With Legend (Leave Blank if no legend needed) |
| <b>K</b>  | Black   |       |          |       |  |           |                     |           |                  |           |                     |           |                    |   |           |         |                 |  |           |     |           |        |           |       |                                       |  |           |     |           |        |           |       |           |       |           |       |   |           |   |
| <b>W</b>  | White   |       |          |       |  |           |                     |           |                  |           |                     |           |                    |   |           |         |                 |  |           |     |           |        |           |       |                                       |  |           |     |           |        |           |       |           |       |           |       |   |           |   |
| <b>XX</b>   | No Led <sup>4</sup>                           |       |          |       |  |           |                     |           |                  |           |                     |           |                    |   |           |         |                 |  |           |     |           |        |           |       |                                       |  |           |     |           |        |           |       |           |       |           |       |   |           |   |
| <b>RS</b>   | Red <sup>5</sup>                              |       |          |       |  |           |                     |           |                  |           |                     |           |                    |   |           |         |                 |  |           |     |           |        |           |       |                                       |  |           |     |           |        |           |       |           |       |           |       |   |           |   |
| <b>YS</b>   | Yellow <sup>5</sup>                           |       |          |       |  |           |                     |           |                  |           |                     |           |                    |   |           |         |                 |  |           |     |           |        |           |       |                                       |  |           |     |           |        |           |       |           |       |           |       |   |           |   |
| <b>GS</b>   | Green <sup>5</sup>                            |       |          |       |  |           |                     |           |                  |           |                     |           |                    |   |           |         |                 |  |           |     |           |        |           |       |                                       |  |           |     |           |        |           |       |           |       |           |       |   |           |   |
| <b>XX</b>   | No Lens                                       |       |          |       |  |           |                     |           |                  |           |                     |           |                    |   |           |         |                 |  |           |     |           |        |           |       |                                       |  |           |     |           |        |           |       |           |       |           |       |   |           |   |
| For LED Display   |   |       |          |       |  |           |                     |           |                  |           |                     |           |                    |   |           |         |                 |  |           |     |           |        |           |       |                                       |  |           |     |           |        |           |       |           |       |           |       |   |           |   |
| <b>DR</b>   | Red   |       |          |       |  |           |                     |           |                  |           |                     |           |                    |   |           |         |                 |  |           |     |           |        |           |       |                                       |  |           |     |           |        |           |       |           |       |           |       |   |           |   |
| <b>DY</b>   | Yellow  |       |          |       |  |           |                     |           |                  |           |                     |           |                    |   |           |         |                 |  |           |     |           |        |           |       |                                       |  |           |     |           |        |           |       |           |       |           |       |   |           |   |
| <b>DG</b>   | Green   |       |          |       |  |           |                     |           |                  |           |                     |           |                    |   |           |         |                 |  |           |     |           |        |           |       |                                       |  |           |     |           |        |           |       |           |       |           |       |   |           |   |
| For Incandescent or Unlighted Display   |   |       |          |       |  |           |                     |           |                  |           |                     |           |                    |   |           |         |                 |  |           |     |           |        |           |       |                                       |  |           |     |           |        |           |       |           |       |           |       |   |           |   |
| <b>LR</b>   | Red   |       |          |       |  |           |                     |           |                  |           |                     |           |                    |   |           |         |                 |  |           |     |           |        |           |       |                                       |  |           |     |           |        |           |       |           |       |           |       |   |           |   |
| <b>LY</b>   | Yellow  |       |          |       |  |           |                     |           |                  |           |                     |           |                    |   |           |         |                 |  |           |     |           |        |           |       |                                       |  |           |     |           |        |           |       |           |       |           |       |   |           |   |
| <b>LG</b>   | Green   |       |          |       |  |           |                     |           |                  |           |                     |           |                    |   |           |         |                 |  |           |     |           |        |           |       |                                       |  |           |     |           |        |           |       |           |       |           |       |   |           |   |
| <b>LW</b>   | White   |       |          |       |  |           |                     |           |                  |           |                     |           |                    |   |           |         |                 |  |           |     |           |        |           |       |                                       |  |           |     |           |        |           |       |           |       |           |       |   |           |   |
| <b>LK</b>   | Black   |       |          |       |  |           |                     |           |                  |           |                     |           |                    |   |           |         |                 |  |           |     |           |        |           |       |                                       |  |           |     |           |        |           |       |           |       |           |       |   |           |   |
| <b>20</b>   | With Legend (Leave Blank if no legend needed) |       |          |       |  |           |                     |           |                  |           |                     |           |                    |   |           |         |                 |  |           |     |           |        |           |       |                                       |  |           |     |           |        |           |       |           |       |           |       |   |           |   |

**CUSTOMER INSTALLATION:**

**LED**

- Order LED and receptacle, page 73.
- Installation instructions, page 73/75.

**Incandescent Lamp**

- Order lamp/PWB receptacle or lamp/solder receptacle, page 74.
- Installation instructions, page 75.

Order display options assembled to switch by adding codes below

|  |   |                                       |              |              |                 |                 |                |                |  |                |  |           |                     |           |                  |           |                     |           |                    |   |             |   |
|--|---|---------------------------------------|--------------|--------------|-----------------|-----------------|----------------|----------------|--|----------------|--|-----------|---------------------|-----------|------------------|-----------|---------------------|-----------|--------------------|---|-------------|---|
| <p><b>H</b></p> <p><b>Button Color (One Piece Plunger)</b></p> <table border="1" style="width: 100%;"> <tr> <td>For LED Display</td> <td>For Incandescent or non-light display</td> </tr> <tr> <td><b>H</b> Red</td> <td><b>R</b> Red</td> </tr> <tr> <td><b>L</b> Yellow</td> <td><b>Y</b> Yellow</td> </tr> <tr> <td><b>N</b> Green</td> <td><b>G</b> Green</td> </tr> <tr> <td></td> <td><b>Z</b> Black</td> </tr> </table> | For LED Display                               | For Incandescent or non-light display | <b>H</b> Red | <b>R</b> Red | <b>L</b> Yellow | <b>Y</b> Yellow | <b>N</b> Green | <b>G</b> Green |  | <b>Z</b> Black | <p><b>RS</b></p> <p><b>LED*</b></p> <table border="1" style="width: 100%;"> <tr> <td><b>XX</b></td> <td>No LED<sup>4</sup></td> </tr> <tr> <td><b>RS</b></td> <td>Red<sup>5</sup></td> </tr> <tr> <td><b>YS</b></td> <td>Yellow<sup>5</sup></td> </tr> <tr> <td><b>GS</b></td> <td>Green<sup>5</sup></td> </tr> </table> | <b>XX</b> | No LED <sup>4</sup> | <b>RS</b> | Red <sup>5</sup> | <b>YS</b> | Yellow <sup>5</sup> | <b>GS</b> | Green <sup>5</sup> | <p><b>Legend</b></p> <table border="1" style="width: 100%;"> <tr> <td><b>XX20</b></td> <td>With Legend (Leave Blank if no legend needed)</td> </tr> </table> <p>Use Legend Order Sheet FO-74024 to cover each catalog listing. (See page 69.)</p> | <b>XX20</b> | With Legend (Leave Blank if no legend needed) |
| For LED Display  | For Incandescent or non-light display         |                                       |              |              |                 |                 |                |                |  |                |  |           |                     |           |                  |           |                     |           |                    |   |             |   |
| <b>H</b> Red   | <b>R</b> Red                                  |                                       |              |              |                 |                 |                |                |  |                |  |           |                     |           |                  |           |                     |           |                    |   |             |   |
| <b>L</b> Yellow  | <b>Y</b> Yellow                               |                                       |              |              |                 |                 |                |                |  |                |  |           |                     |           |                  |           |                     |           |                    |   |             |   |
| <b>N</b> Green   | <b>G</b> Green                                |                                       |              |              |                 |                 |                |                |  |                |  |           |                     |           |                  |           |                     |           |                    |   |             |   |
|  | <b>Z</b> Black                                |                                       |              |              |                 |                 |                |                |  |                |  |           |                     |           |                  |           |                     |           |                    |   |             |   |
| <b>XX</b>  | No LED <sup>4</sup>                           |                                       |              |              |                 |                 |                |                |  |                |  |           |                     |           |                  |           |                     |           |                    |   |             |   |
| <b>RS</b>  | Red <sup>5</sup>                              |                                       |              |              |                 |                 |                |                |  |                |  |           |                     |           |                  |           |                     |           |                    |   |             |   |
| <b>YS</b>  | Yellow <sup>5</sup>                           |                                       |              |              |                 |                 |                |                |  |                |  |           |                     |           |                  |           |                     |           |                    |   |             |   |
| <b>GS</b>  | Green <sup>5</sup>                            |                                       |              |              |                 |                 |                |                |  |                |  |           |                     |           |                  |           |                     |           |                    |   |             |   |
| <b>XX20</b>  | With Legend (Leave Blank if no legend needed) |                                       |              |              |                 |                 |                |                |  |                |  |           |                     |           |                  |           |                     |           |                    |   |             |   |

- \*Notes:**
- When an LED is specified in a **rectangular** MML21 listing, MICRO SWITCH will permanently install it in the housing.
  - MICRO SWITCH does **not** permanently install an LED in a **square** MML21 listing. To install an LED in a square housing, order a MML93L or MML93G receptacle and a MML92 LED (see pages 86 and 88).
  - Include four digits (XXXX or XX DR) when a legend is required.
  - For square or rectangular only.
  - For rectangular only.

Manuals

# Manual Switches

## Electronic Control Rocker Switches

MML24 Series

LED, INCANDESCENT, OR NON-LIGHTED DISPLAY



PWB Mount



Panel Mount



PWB Mount  
(Lighted rocker)

**FEATURES**

- Accepts one or two LEDs or incandescent lamps which are ordered separately
- Printed wiring board mounting or snap-in panel mounting
- Bezels and mounting clips can be furnished installed or ordered separately
- UL recognized, CSA certified

**MML24 ORDER GUIDE** (Catalog listing for switch, less assembled display options)

| MML24K                  | A  | 3                                  | AA                                       |
|-------------------------|--|------------------------------------|--|
| <b>Housing Type</b>     | <b>Mounting</b>  | <b>Terminals</b>                   | <b>Circuitry</b>                         |
| MML24K<br>Black housing | A No bezel (PWB mounting)<br>K Black bezel, mtg. clip/long sides | 3 Printed wiring board<br>2 Solder | Insert code letters from Circuitry Chart |

|                           |             |
|---------------------------|-------------|
| Electrical Data           | page 57     |
| Bezels                    | page 72     |
| Strip and matrix mounting | page 71     |
| Mounting dimensions       | pages 85/86 |
| PWB pin locations         | page 85     |

Rockers are permanently installed.

### CIRCUITRY

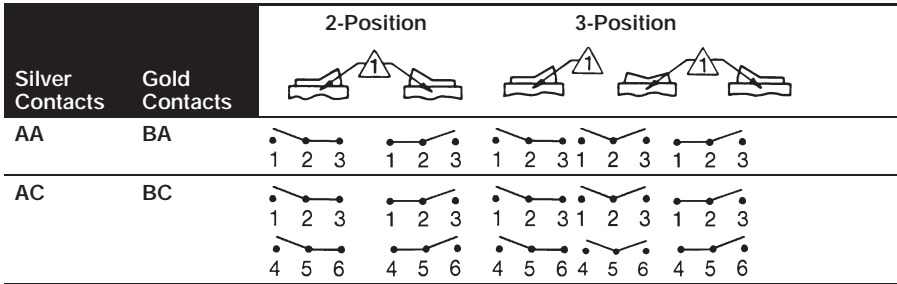

**Example: MML24KA3AA01HDRXX**  
 Electronic control rocker switch with black housing, printed wiring board terminals; 1 pole, silver contacts; 2-position, maintained action; one circuit ON in each position; black rocker, red lens for LED display in Side 1 and no lens in Side 2.

⚠ The "MICRO SWITCH" identification is shown on this side of the switch housings.

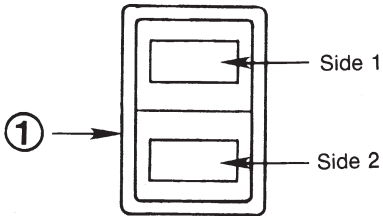

### OPERATING ACTION

| 2-Position | 01 | Maint. | None   | Maint. |
|------------|----|--------|--------|--------|
|            | 02 | Mom.   | None   | Maint. |
|            | 03 | Maint. | None   | Mom.   |
| 3-Position | 04 | Maint. | Maint. | Maint. |
|            | 05 | Mom.   | Maint. | Mom.   |
|            | 07 | Mom.   | Maint. | Maint. |

Order display options assembled to switch by adding codes below.

| <b>01</b>  | <b>H</b>   | <b>DRXX</b>  | Leave blank, if legend not desired |  |        |  |    |      |    |      |              |                  |              |                  |        |        |        |        |           |           |           |           |          |          |          |          |  |          |  |          |   |
|--|--|--|------------------------------------|--|--------|--|----|------|----|------|--------------|------------------|--------------|------------------|--------|--------|--------|--------|-----------|-----------|-----------|-----------|----------|----------|----------|----------|--|----------|--|----------|---|
| <b>Action</b><br>Insert code numbers from Operating Action Chart | <b>Rocker</b><br>K Black rocker, non-lighted<br>H Black rocker, one lens*<br>F White rocker, one lens*<br><small>* Lighted switches with solder terminals require MML93R receptacle to install lamps or LEDs. See page 76.</small> | <table border="1"> <thead> <tr> <th colspan="2">Side 1</th> <th colspan="2">Side 2</th> </tr> </thead> <tbody> <tr> <td>XX</td> <td>None</td> <td>XX</td> <td>None</td> </tr> <tr> <td>LED display:</td> <td>Incand. display:</td> <td>LED display:</td> <td>Incand. display:</td> </tr> <tr> <td>DR Red</td> <td>LR Red</td> <td>DR Red</td> <td>LR Red</td> </tr> <tr> <td>DY Yellow</td> <td>LY Yellow</td> <td>DY Yellow</td> <td>LY Yellow</td> </tr> <tr> <td>DG Green</td> <td>LG Green</td> <td>DG Green</td> <td>LG Green</td> </tr> <tr> <td></td> <td>LW White</td> <td></td> <td>LW White</td> </tr> </tbody> </table> | Side 1                             |  | Side 2 |  | XX | None | XX | None | LED display: | Incand. display: | LED display: | Incand. display: | DR Red | LR Red | DR Red | LR Red | DY Yellow | LY Yellow | DY Yellow | LY Yellow | DG Green | LG Green | DG Green | LG Green |  | LW White |  | LW White | <b>Legend</b><br>20 With legend<br><br>Use legend order sheet FO-74193 to cover each catalog listing (see page 70). |
| Side 1   |  | Side 2   |                                    |  |        |  |    |      |    |      |              |                  |              |                  |        |        |        |        |           |           |           |           |          |          |          |          |  |          |  |          |   |
| XX   | None   | XX   | None                               |  |        |  |    |      |    |      |              |                  |              |                  |        |        |        |        |           |           |           |           |          |          |          |          |  |          |  |          |   |
| LED display:   | Incand. display:   | LED display:   | Incand. display:                   |  |        |  |    |      |    |      |              |                  |              |                  |        |        |        |        |           |           |           |           |          |          |          |          |  |          |  |          |   |
| DR Red   | LR Red   | DR Red   | LR Red                             |  |        |  |    |      |    |      |              |                  |              |                  |        |        |        |        |           |           |           |           |          |          |          |          |  |          |  |          |   |
| DY Yellow  | LY Yellow  | DY Yellow  | LY Yellow                          |  |        |  |    |      |    |      |              |                  |              |                  |        |        |        |        |           |           |           |           |          |          |          |          |  |          |  |          |   |
| DG Green   | LG Green   | DG Green   | LG Green                           |  |        |  |    |      |    |      |              |                  |              |                  |        |        |        |        |           |           |           |           |          |          |          |          |  |          |  |          |   |
|  | LW White   |  | LW White                           |  |        |  |    |      |    |      |              |                  |              |                  |        |        |        |        |           |           |           |           |          |          |          |          |  |          |  |          |   |

**CUSTOMER INSTALLATION:**

**LED**

- Order LED and receptacle, page 73.
- Installation instructions, pages 74/76.

**Incandescent Lamp**

- Order lamp/PWB receptacle or lamp/solder receptacle, page 75.
- Installation instructions, page 76.

Manuals

# Manual Switches

## Power Duty Pushbutton

### NON-LIGHTED DISPLAY



PWB Mount



Panel Mount

### FEATURES

- Printed circuit board or snap-in panel mounting
- Bezels and mounting clips, and legended lenses can be furnished installed or ordered separately
- UL recognized, CSA certified.

### Example: MML31KK2AAK

Power duty pushbutton switch housing (black); bezel (black) and mounting clips; solder terminals; 1 pole, momentary action; black plunger.

### Example: MML31KK2AAKLR

As above, except furnished with red lens.

### MML31 ORDER GUIDE

Catalog listing codes for switch, less assembled display options

#### MML31K

#### Housing Type (Rectangular)

**MML31K**  
Black housing, non-lighted

#### K

#### Mounting

**A** No bezel (PWB mounting)  
**K** Black bezel, mtg. clip/long sides

#### 2

#### Terminals

**3** Printed wiring board  
**2** Solder/Quick-connect

#### AA

#### Circuitry/Action

(Each pole is single-throw, normally open)

**AA** 1 pole, mom. action  
**AB** 1 pole, alt. action  
**AC** 2 poles, mom. action  
**AD** 2 poles, alt. action

|                           |             |
|---------------------------|-------------|
| Electrical Data           | page 57     |
| Bezels                    | page 72     |
| Strip and matrix mounting | page 71     |
| Mounting dimensions       | pages 85/86 |
| PWB pin locations         | page 85     |

Order display options assembled to switch by adding codes below

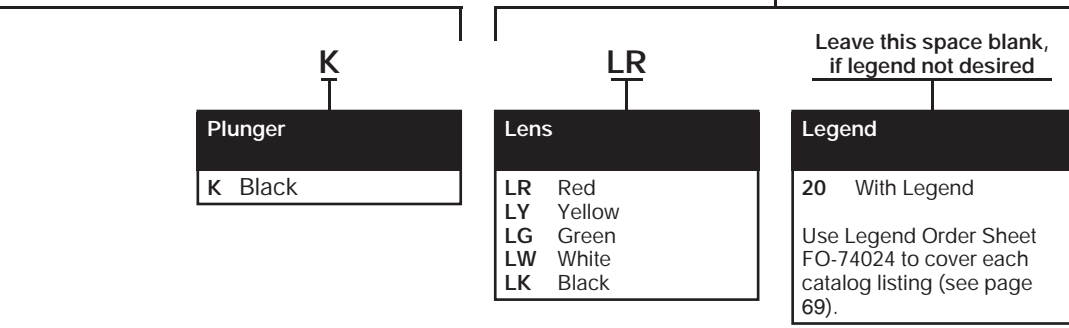

Manuals

# Manual Switches

## Indicators/Pushbutton Style

MML41/46 Series

### LED OR INCANDESCENT DISPLAY



PWB Mount



Panel Mount

### FEATURES

- Accepts one LED or incandescent lamp

MML41 indicators resemble a pushbutton switch with the button in the "down" position.

### MML41 ORDER GUIDE

Catalog listing codes for indicator, less assembled display options

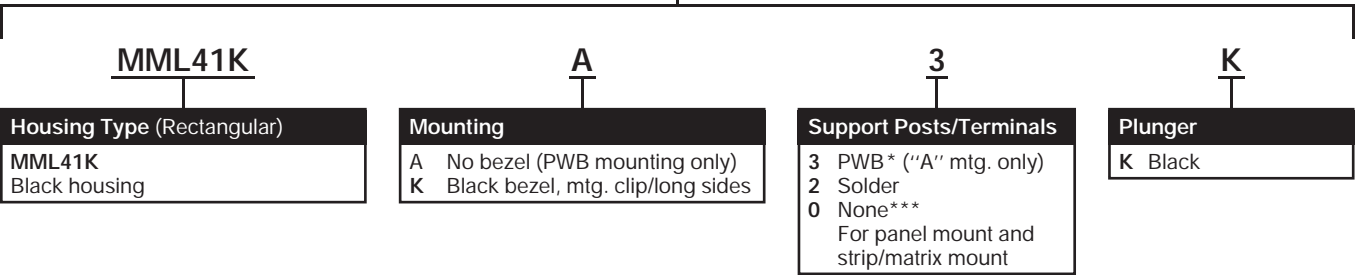

# Indicators/Flush Mount MML46

### LED OR INCANDESCENT DISPLAY



PWB Mount



Panel Mount



PWB Mount



Panel Mount

### FEATURES

- Accepts one or two LEDs or incandescent lamps
- Bezels and mounting clips, LEDs and legended lenses can be furnished installed or ordered separately

### MML46 ORDER GUIDE

Catalog listing codes for indicator, less assembled display options

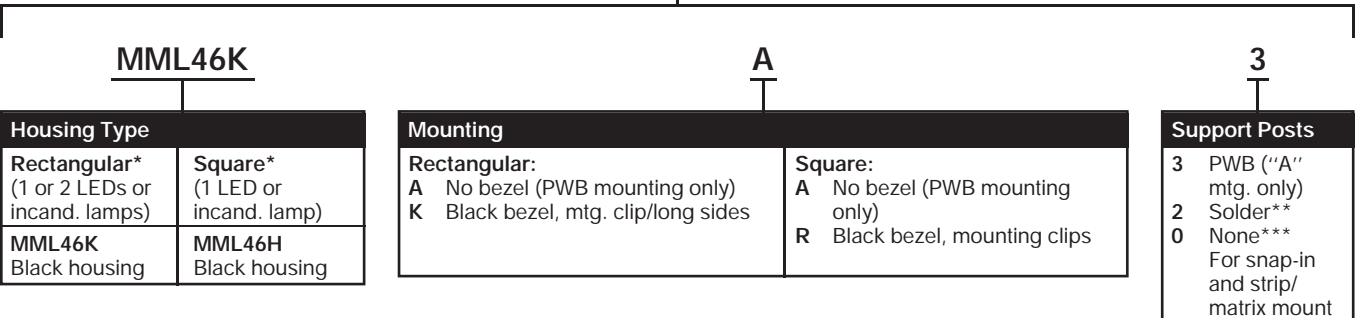

\*\* Rectangular housings only.  
\*\*\* No LEDs allowed.

\* Notes:  
1. When an LED is specified in a rectangular MML46 listing, MICRO SWITCH will permanently install it in the housing.  
2. MICRO SWITCH does **not** permanently install an LED in a square MML46 listing. To install an LED in a square housing, order a MML93L or MML93G receptacle and a MML92 LED (see pages 74 and 76).

# Manual Switches

## Indicators/Pushbutton Style

**Example: MML41KA3K**  
 Pushbutton style indicator housing (black); no bezel; support posts; black plunger.

**Example: MML41KA3KRSDR**  
 As above, except furnished with one red LED and red lens.

|                           |                |
|---------------------------|----------------|
| Electrical Data           | page 57        |
| Lenses                    | page 68        |
| Bezels                    | page 72        |
| LEDs/Lamps                | pages 73/75    |
| Strip and matrix mounting | page 71        |
| Mounting dimensions       | pages 80/82/83 |
| PWB pin locations         | pages 80/84    |

Order display options assembled to indicator by adding codes below

|   |   |  |           |     |           |        |           |       |   |  |   |  |           |             |
|---|---|--|-----------|-----|-----------|--------|-----------|-------|---|--|---|--|-----------|-------------|
| <b>RS</b>   | <b>DR</b>   | Leave this space blank if legend not desired |           |     |           |        |           |       |   |  |   |  |           |             |
| <b>LED (Stanley type)</b>   | <b>Lens</b>   | <b>Legend</b>                                |           |     |           |        |           |       |   |  |   |  |           |             |
| <table style="width:100%; border-collapse: collapse;"> <tr> <td style="width: 15%;"><b>XX</b></td> <td>None</td> </tr> <tr> <td><b>RS</b></td> <td>Red</td> </tr> <tr> <td><b>YS</b></td> <td>Yellow</td> </tr> <tr> <td><b>GS</b></td> <td>Green</td> </tr> </table> | <b>XX</b>   | None   | <b>RS</b> | Red | <b>YS</b> | Yellow | <b>GS</b> | Green | <table style="width:100%; border-collapse: collapse;"> <tr> <td style="width: 50%; vertical-align: top;">                     For LED display:<br/> <b>DR</b> Red<br/> <b>DY</b> Yellow<br/> <b>DG</b> Green                 </td> <td style="width: 50%; vertical-align: top;">                     For incandescent or non-lighted display:*<br/> <b>LR</b> Red<br/> <b>LY</b> Yellow<br/> <b>LG</b> Green<br/> <b>LW</b> White<br/> <b>LK</b> Black                 </td> </tr> </table> | For LED display:<br><b>DR</b> Red<br><b>DY</b> Yellow<br><b>DG</b> Green | For incandescent or non-lighted display:*<br><b>LR</b> Red<br><b>LY</b> Yellow<br><b>LG</b> Green<br><b>LW</b> White<br><b>LK</b> Black | <table style="width:100%; border-collapse: collapse;"> <tr> <td style="width: 15%;"><b>20</b></td> <td>With legend</td> </tr> </table> Use Legend Order Sheet FO-74024 to cover each catalog listing (see page 69).<br>Note: If legend is not desired, leave this space blank. | <b>20</b> | With legend |
| <b>XX</b>   | None  |  |           |     |           |        |           |       |   |  |   |  |           |             |
| <b>RS</b>   | Red   |  |           |     |           |        |           |       |   |  |   |  |           |             |
| <b>YS</b>   | Yellow  |  |           |     |           |        |           |       |   |  |   |  |           |             |
| <b>GS</b>   | Green   |  |           |     |           |        |           |       |   |  |   |  |           |             |
| For LED display:<br><b>DR</b> Red<br><b>DY</b> Yellow<br><b>DG</b> Green  | For incandescent or non-lighted display:*<br><b>LR</b> Red<br><b>LY</b> Yellow<br><b>LG</b> Green<br><b>LW</b> White<br><b>LK</b> Black |  |           |     |           |        |           |       |   |  |   |  |           |             |
| <b>20</b>   | With legend   |  |           |     |           |        |           |       |   |  |   |  |           |             |

**Example: MML46KA3**  
 Indicator housing, rectangular (black); no bezel; support terminals.

**Example: MML46KA3RSXXDR20**  
 As above, except furnished with red LED and red lens, with legend.

\* When ordering incandescent or non lighted display, LED field must be XX.

**CUSTOMER INSTALLATION:**

**LED**

- Order LED and receptacle, page 73.
- Installation instructions, pages 74/76.

**Incandescent Lamp**

- Order lamp/PWB receptacle or lamp/solder receptacle, page 75.
- Installation instructions, page 76.

**LED TERMINATION**

If LEDs are to be permanently installed by MICRO SWITCH, please indicate by either a **2** (solder) or a **3** (PWB) for the Support Posts listing code. With MICRO SWITCH identification to the rear, the longest lead (+) anode will be to the left, closest to the double-pole circuit or support terminals.



Style 2



Style 3

Manuals

Order display options assembled to indicator by adding codes below

|  |   |  |                    |                    |                   |                   |   |  |   |   |           |             |
|--|---|--|--------------------|--------------------|-------------------|-------------------|---|--|---|---|-----------|-------------|
| <b>RSXX</b>  | <b>DR</b>   | Leave this space blank if legend not desired |                    |                    |                   |                   |   |  |   |   |           |             |
| <b>LED (Stanley type)</b>  | <b>Lens</b>   | <b>Legend</b>                                |                    |                    |                   |                   |   |  |   |   |           |             |
| Available in rectangular housings only.<br><b>XXXX</b> No LED<br>One LED*:<br><table style="width:100%; border-collapse: collapse;"> <tr> <td style="width: 50%;"><b>RSXX</b> Red</td> <td style="width: 50%;"><b>RSRS</b> Red</td> </tr> <tr> <td><b>YSXX</b> Yellow</td> <td><b>YSYS</b> Yellow</td> </tr> <tr> <td><b>GSXX</b> Green</td> <td><b>GSGS</b> Green</td> </tr> </table> | <b>RSXX</b> Red   | <b>RSRS</b> Red                              | <b>YSXX</b> Yellow | <b>YSYS</b> Yellow | <b>GSXX</b> Green | <b>GSGS</b> Green | <table style="width:100%; border-collapse: collapse;"> <tr> <td style="width: 50%; vertical-align: top;">                     For LED display:<br/> <b>DR</b> Red<br/> <b>DY</b> Yellow<br/> <b>DG</b> Green                 </td> <td style="width: 50%; vertical-align: top;">                     For incandescent or non-lighted display:*<br/> <b>LR</b> Red<br/> <b>LY</b> Yellow<br/> <b>LG</b> Green<br/> <b>LW</b> White<br/> <b>LK</b> Black                 </td> </tr> </table> | For LED display:<br><b>DR</b> Red<br><b>DY</b> Yellow<br><b>DG</b> Green | For incandescent or non-lighted display:*<br><b>LR</b> Red<br><b>LY</b> Yellow<br><b>LG</b> Green<br><b>LW</b> White<br><b>LK</b> Black | <table style="width:100%; border-collapse: collapse;"> <tr> <td style="width: 15%;"><b>20</b></td> <td>With legend</td> </tr> </table> Use Legend Order Sheet FO-74024 to cover each catalog listing. | <b>20</b> | With legend |
| <b>RSXX</b> Red  | <b>RSRS</b> Red   |  |                    |                    |                   |                   |   |  |   |   |           |             |
| <b>YSXX</b> Yellow   | <b>YSYS</b> Yellow  |  |                    |                    |                   |                   |   |  |   |   |           |             |
| <b>GSXX</b> Green  | <b>GSGS</b> Green   |  |                    |                    |                   |                   |   |  |   |   |           |             |
| For LED display:<br><b>DR</b> Red<br><b>DY</b> Yellow<br><b>DG</b> Green   | For incandescent or non-lighted display:*<br><b>LR</b> Red<br><b>LY</b> Yellow<br><b>LG</b> Green<br><b>LW</b> White<br><b>LK</b> Black |  |                    |                    |                   |                   |   |  |   |   |           |             |
| <b>20</b>  | With legend   |  |                    |                    |                   |                   |   |  |   |   |           |             |

Square housings accept only one LED. Only a two-character LED code is necessary.  
 Example: MML46HR0XXDY.

\* When ordering incandescent or non-lighted display, LED field must be XXXX.

# Manual Switches

## Button Lenses/Incandescent or Non-lighted Display

### MML51 ORDER GUIDE

For standard plunger MML pushbuttons.

#### MML51E

| Lens Type                  |
|----------------------------|
| <b>Rectangular Lenses:</b> |
| MML51E<br>Switch lens*     |
| MML51G<br>Indicator lens   |
| <b>Square Lenses:</b>      |
| MML51C<br>Switch lens      |
| MML51D**<br>Indicator lens |

#### 20

| Display/Legend Type       |
|---------------------------|
| <b>Transmitted Color:</b> |
| 10 No legend              |
| 20 With legend            |

#### R

| Color               |
|---------------------|
| R Red               |
| Y Yellow            |
| G Green             |
| W White             |
| K Black<br>(Opaque) |

#### Example: MML51E20R

Incandescent or non-lighted display switch lens; red transmitted color, with legend.

#### LEGENDING

Use the MML Legend Order Sheets on pages 81 and 82 to specify legending.

\* Use MML51E with MML41 rectangular pushbutton style indicators.

\*\* MML51D for use with MML41 square.

## Button Lenses/LED

## MML52

### MML52 ORDER GUIDE

For standard plunger MML pushbuttons.

#### MML52G

| Lens Type                                |
|--|
| <b>Rectangular Lenses:</b>               |
| MML52E<br>Switch lens, LED display       |
| MML52G*<br>Indicator lens<br>LED display |
| <b>Square Lenses:</b>                    |
| MML52C<br>Switch lens, LED display       |
| MML52D**<br>Indicator lens, LED display  |

#### 10

| Display/Legend Type       |
|---------------------------|
| <b>Transmitted Color:</b> |
| 10 No legend              |
| 20 With legend            |

#### Y

| Color/<br>Illumination |
|------------------------|
| <b>LED Display:</b>    |
| R Red                  |
| Y Yellow               |
| G Green                |
| C Clear                |

Square lenses have tabs on two sides. Before snapping in place, the tabs should be at right angles to the housing side with the MICRO SWITCH logo. (See below.)

MICRO SWITCH logo on housing

← Lens key tab

#### Example: MML52G10Y

LED display indicator lens; yellow transmitted color, no legend.

\* Use MML52E with MML41 rectangular pushbutton style indicators.

\*\* Use MML52D with MML41 square.

### HOW TO INSTALL LENSES

Keytabs on two sides of the lenses mate with matching button slots.

**Rectangular** lenses have tabs on the long sides. Seat a long side before snapping in place.

### HOW TO INSTALL LENSES

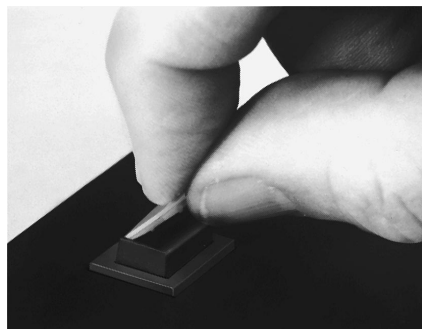

1. Seat lens.

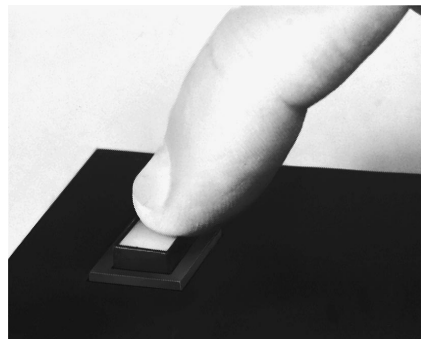

2. Snap in place.







# Manual Switches

## Strip Mounting Frames

MML61 Series

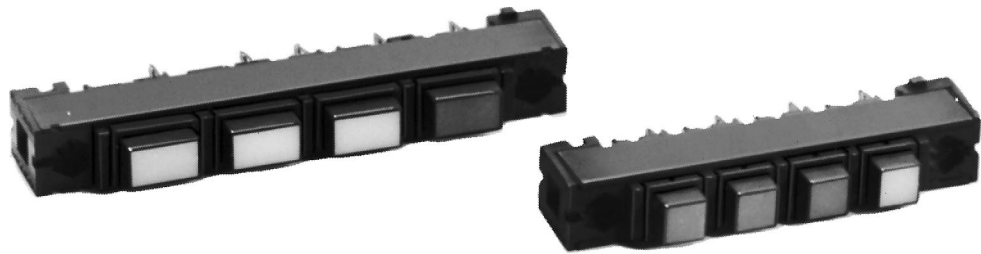

**MML61 ORDER GUIDE**

**MML61K**

| Orientation/Color                        |
|--|
| <b>For Rectangular* Housings:</b>        |
| <b>MML61K</b><br>Horizontal strip, black |
| <b>MML61G</b><br>Vertical strip, black   |
| <b>For Square Housings</b>               |
| <b>MML61J</b><br>Black                   |

\* \* .4" x .6" housings only.

**5**

| No. of Stations |
|-----------------|
| 1 One           |
| 2 Two           |
| 3 Three         |
| 4 Four          |
| 5 Five          |
| 6 Six           |
| 7 Seven         |
| 8 Eight         |
| 9 Nine          |
| 10 Ten          |

Note: Switches and indicators are ordered as separate items.

- FEATURES**
- Provides back of panel or printed wiring board mounting in a multi-unit strip of switches/indicators.
  - Devices can be pre-wired prior to installation.
  - Holes at each end of frame will accept No. 4 screws.
  - Can be used for pushbutton or rocker type switches.

**Example: MML61K5**  
Black 5-station strip mounting frame, horizontal orientation.

Manuals

# Manual Switches

## Bezels/Mounting Clips

MML72 Series

**MML72EEK**  
(Black switch bezel, mounting clips on long sides)

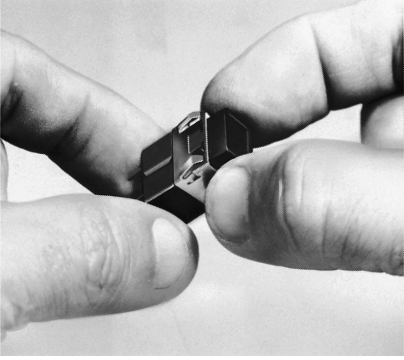

1. Slip mounting clip over top of switch/indicator housing.

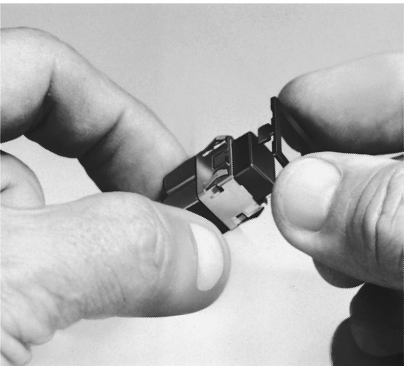

2. Snap bezel onto mounting clip.

Recommended panel thickness for panel mounted units is .050 to .094 in. (1,27 to 2,39 mm).

### TO ORDER MOUNTING CLIPS SEPARATELY

|                           |               |
|---------------------------|---------------|
| For Rectangular Housings: |               |
| <b>MML73EA</b>            | (long sides)  |
| <b>MML73EB</b>            | (short sides) |

### LED APPLICATION INFORMATION

To insure stable conditions, suitable external control of the LED current must be provided. It is recommended that a minimum of 5 VDC open circuit voltage with an appropriate series resistance be used to drive LED devices. This minimizes current variation and its effect on temperature and forward voltage of the LED.

Resistor values can be determined by supply voltage or current for LED:

$$R_s = \frac{E - V_f}{I_f}$$

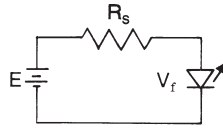

WHERE:  $R_s$  = Series Resistance  
 $E$  = Supply Voltage  
 $V_f$  = Forward Voltage of LED  
 $I_f$  = Circuit Current

Maximum drive current is 30 mA. Reverse voltage breakdown of the LED's is 4 volts (min.).

### MML92 ORDER GUIDE

LEDs should be the same color as the lenses they illuminate. They are packed 10 per listing, including stand-off spacers for use when solder terminating to a printed wiring board, per procedure 3 on page 74.

| LED Type          | Use To Illuminate   | Catalog Listing                  | LED Color              | Forward Characteristics Typ. @ 20mA | Max.  | LED Manufacturers' Part Numbers     |
|-------------------|---|----------------------------------|------------------------|-------------------------------------|---|-------------------------------------|
| T-1 $\frac{3}{4}$ | Rectangular button lens                                       | MML92ERS<br>MML92EGS<br>MML92EYS | Red<br>Green<br>Yellow | 1.7 V<br>2.1 V<br>2.1 V             | Stanley:<br>2.0 V<br>2.5 V<br>2.5 V         | ESBR5633<br>ESBG5633<br>ESAY5633    |
|                   |   | MML92ERH<br>MML92EGH<br>MML92EYH | Red<br>Green<br>Yellow | 2.2 V<br>2.3 V<br>2.2 V             | Hewlett Packard:<br>3.0 V<br>3.0 V<br>3.0 V | HLMP-3366<br>HLMP-3568<br>HLMP-3466 |
| T-1               | Square button lens, MML24 rocker lens rectangular button lens | MML92HRS<br>MML92HGS<br>MML92HYS | Red<br>Green<br>Yellow | 1.7 V<br>2.1 V<br>2.2 V             | Stanley:<br>2.0 V<br>2.5 V<br>2.5 V         | ESBR3901<br>ESPY3901<br>ESAY3901    |
|                   |   | MML92HRH<br>MML92HGH<br>MML92HYH | Red<br>Green<br>Yellow | 2.2 V*<br>2.3 V*<br>2.2 V           | Hewlett Packard:<br>3.0 V<br>3.0 V<br>3.0 V | HLMP-1340<br>HLMP-1540<br>HLMP-1440 |

Long lead: Anode (+). Short lead: Cathode (-).  
 \* @ 25 mA.

Manuals

### MML93 LED PWB RECEPTACLE ORDER GUIDE

| LED Type          | Use to Illuminate                               | Catalog Listing |
|-------------------|---|-----------------|
| T-1 $\frac{3}{4}$ | Rectangular button lens or umbrella button lens | MML93K          |
| T-1               | Square button lens or MML24 rocker lens         | MML93G          |

### MML93 LED SOLDER TERMINAL ORDER GUIDE

| LED Type | Use to Illuminate                      | Catalog Listing |
|----------|--|-----------------|
| T-1      | Square button (base only)              | MML93L          |
| T-1      | MML24 rocker lens (base only)          | MML93R          |
| T-1      | Rectangular button (base and terminal) | MML93J          |

**Factory installed.** Certain MML switches and indicators can be furnished with LEDs permanently factory installed, where specified in the order guides.

**User installed.** LEDs can also be ordered separately and installed in these products by the user, per the procedures described below.

### LED INSTALLATION

#### 1. With Printed Wiring Board Receptacle. (MML93K)

PWB receptacle enables T-1  $\frac{3}{4}$  or T-1 LEDs to be added or replaced behind the printed wiring board, without soldering. LEDs and receptacles are ordered separately. See page 75.

Printed wiring boards are not supplied.

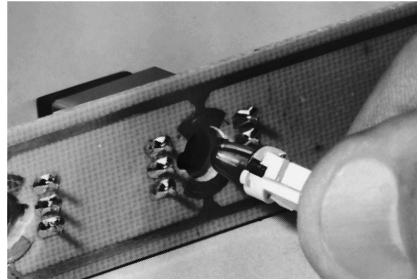

1. Insert the LED/PWB receptacle assembly through a hole in the printed wiring board.

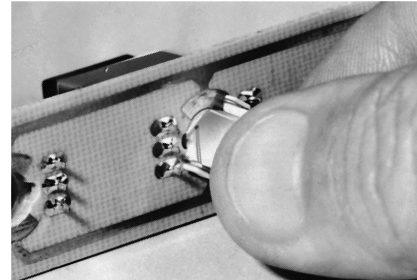

2. A  $\frac{1}{8}$ -turn applied clockwise to the receptacle locks it in the printed wiring board and establishes the electrical connection.

#### 2. With Solder Terminal Receptacle. (MML93J)

This receptacle attaches directly to the rear of panel-mounted units. It enables incandescent lamps to be added or replaced without rewiring. LEDs and receptacles are ordered separately.

This receptacle is for use with all rectangular pushbuttons and MML41 or MML46 rectangular indicators only.

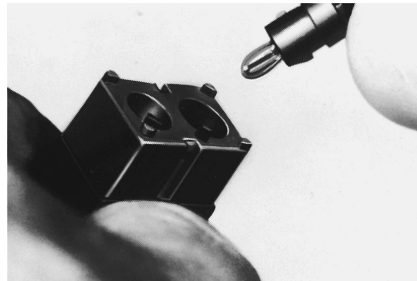

1. Insert solder terminal receptacle into hole in base of panel mount unit.

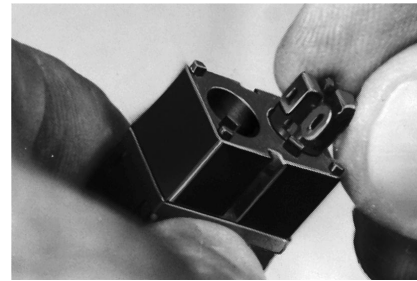

2. A  $\frac{1}{8}$ -turn clockwise applied to the receptacle locks it in the base.

#### 3. By Soldering To Printed Wiring Board.

In this procedure, the housing is mounted on the printed wiring board after the T-1  $\frac{3}{4}$  LED has been seated.

This procedure can be used with any MML having PWB terminals.

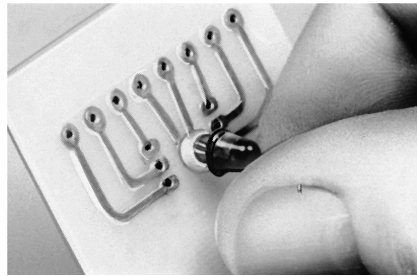

1. Assemble stand-off spacer to LED terminals and seat on printed wiring board.

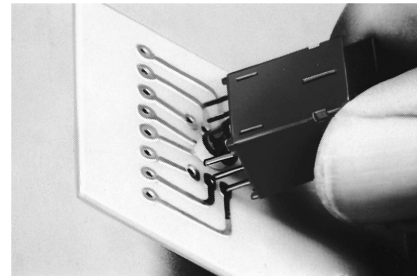

2. Seat housing on printed wiring board, with LED projecting into hole at the base of the housing.

#### 4. By Soldering to Printed Wiring Board or Leadwire (MML44 indicators only).

T-1  $\frac{3}{4}$  LEDs are added to MML44 indicators via a procedure which is unique to this product. The LED is inserted from the top of the housing with the leadwires protruding through the housing base.

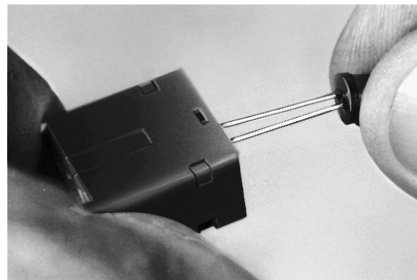

1. Assemble LED to MML44 indicator, with the LED terminals protruding through assembly slot in the middle of housing base.

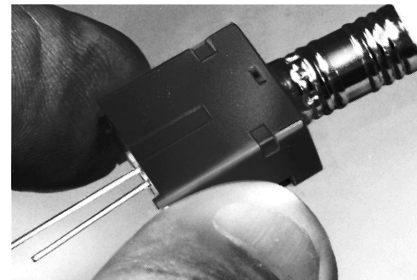

2. Use pencil eraser to snap LED securely in place.

# Manual Switches

## Incandescent Lamp Assemblies

### MML91 LAMP/PWB RECEPTACLE ORDER GUIDE

| Lamp Type          | Use To Illuminate                        | Voltage | Catalog Listing Incl. Lamp & PWB Receptacle | Industry Lamp No. |
|--------------------|--|---------|---|-------------------|
| T-1 ①<br>(unbased) | Rectangular button lens                  | 5<br>28 | MML91C<br>MML91DC                           | 715<br>6838       |
| T-1 ②<br>(bi-pin)  | Square button lens and MML24 rocker lens | 5<br>28 | MML91E<br>MML91DE                           | 7715<br>7839      |

Notes:

① To order PWB receptacle separately, specify **MML93H**.

② To order PWB receptacle separately, specify **MML93G**.

### MML91 LAMP/SOLDER RECEPTACLE ORDER GUIDE

| Lamp Type         | Use To Illuminate       | Voltage | Catalog Listing Incl. Lamp & Solder Receptacle | Industry Lamp No. |
|-------------------|-------------------------|---------|--|-------------------|
| T-1 ③<br>(bi-pin) | Rectangular button lens | 5<br>28 | MML91D<br>MML91DD                              | 7715<br>7839      |

| Lamp Type        | Use To Illuminate  | Voltage | Catalog Listing ④ |                         | Industry Lamp No. |
|------------------|--------------------|---------|-------------------|-------------------------|-------------------|
|                  |                    |         | Solder Receptacle | T-1 (Unbased) Lamp Only |                   |
| T-1<br>(unbased) | Square button lens | 5<br>28 | MML93L<br>MML93L  | MML91A<br>MML91DA       | 715<br>6838       |
| T-1<br>(unbased) | MML24 rocker lens  | 5<br>28 | MML93R<br>MML93R  | MML91A<br>MML91DA       | 715<br>6838       |

Notes:

③ To order solder receptacles separately, specify **MML93J**.

④ Order solder receptacles and T-1 lamp listings for complete assembly.

Manuals

## LED/Incandescent Lamp Receptacles

**User installed.** Certain MML switches and indicators will accept incandescent lamps, where specified in the order guides.

These lamps are ordered separately and installed by the user, per the procedures described below.

### LAMP INSTALLATION

#### 1. With Printed Wiring Board Receptacle for MML93G and MML93H only.

Use PWB receptacles to permit lamps to be added or replaced from behind the printed wiring board, without soldering.

These receptacles are for use with rectangular pushbuttons, square pushbuttons and MML24 rocker lens only.

Printed wiring boards are not supplied.

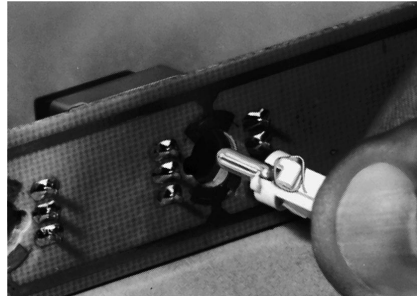

1. Insert the PWB receptacle/incandescent lamp assembly through a hole in the printed wiring board.

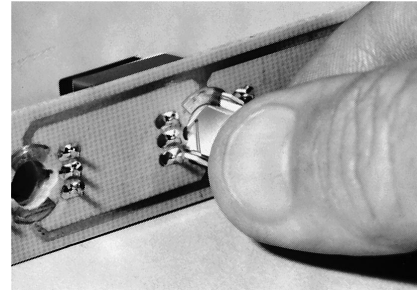

2. A 1/8-turn applied clockwise to the receptacle locks it in the printed wiring board and establishes the electrical connection.

#### 2. With Solder Terminal Receptacle for MML93J bi-pin only

This receptacle attaches directly to the rear of panel-mounted units. It enables lamps to be added or replaced without rewiring.

This receptacle is for use with all rectangular pushbuttons and MML41 or MML46 rectangular indicators only.

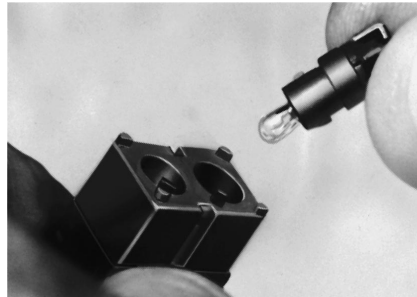

1. Insert solder terminal receptacle into hole in base of panel mount unit.

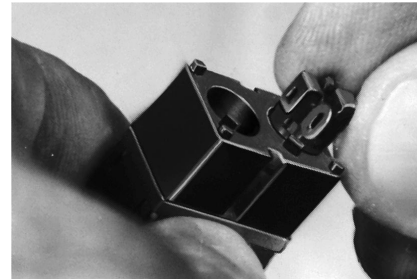

2. A 1/8-turn clockwise applied to the receptacle locks it in the base.

#### 3. With Solder Terminal Receptacles for MML93L/93R Unbased Only or T-1 LED.

Use the receptacles shown at right to install T-1 LEDs or T-1 unbased lamps in panel-mounted MML21 square pushbutton switches and MML24 rocker switches.

#### Procedure:

1. Assemble LEDs or lamps to receptacles (leads first).
2. Snap receptacle into slots in housing base.
3. Solder directly to leads.

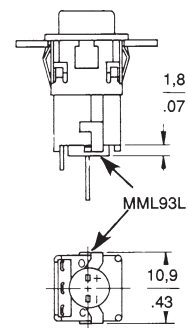
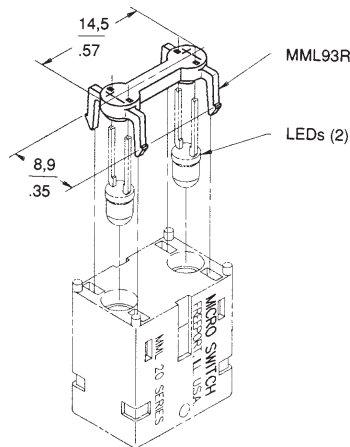



# Manual Switches

## Miniature Manual Line

MOUNTING DIMENSIONS (For reference only)

### PANEL CUTOUTS FOR PUSHBUTTON SWITCHES AND INDICATORS/RECTANGULAR TYPE

#### INDIVIDUAL SNAP-IN PANEL MOUNT

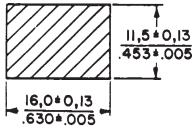

1.27 — 2.39  
.050 — .094  
Panel Thickness

#### PANEL PUNCH FOR MML SERIES

A panel punch is manufactured by Greenlee-Textron Tool Co., Rockford, IL (815-926-3011).

#### INDIVIDUAL PRINTED WIRING BOARD (PWB) MOUNT

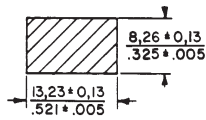

Pushbutton Plunger Thru Panel

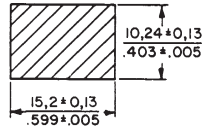

Housing Thru Panel

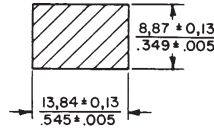

Indicator Lens Thru Panel

#### MULTI-UNIT PRINTED WIRING BOARD (PWB) MOUNT

##### Horizontal Mount

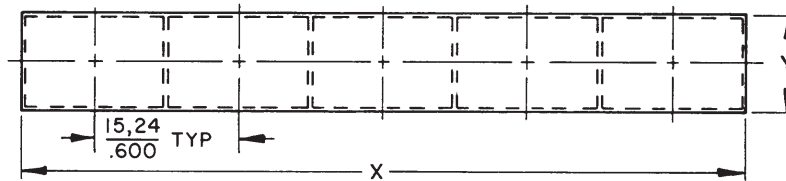
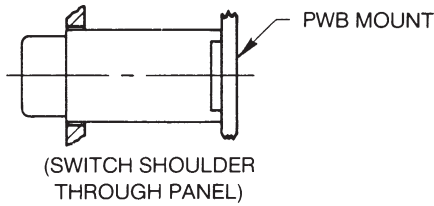

Establish tooling holes on X coordinate and use these holes to establish relationship between PWB and Panel

$$\text{Terminals } \frac{0.20}{.008} \times \frac{0.76}{.030}$$

Recommended hole size in PWB  $\frac{1.17}{.046}$

$$\begin{aligned} N &= \text{Number of switches} \\ X &= N-1 \times \frac{15.24}{.600} + \frac{15.11}{.595} \\ Y &= \frac{10.16}{.400} \end{aligned}$$

$$\begin{aligned} \text{Example: } N &= 5 \text{ Switches} \\ X &= 5-1 \times \frac{15.24}{.600} + \frac{15.11}{.595} \\ X &= \frac{76.07}{2.995} \end{aligned}$$

##### Vertical Mount

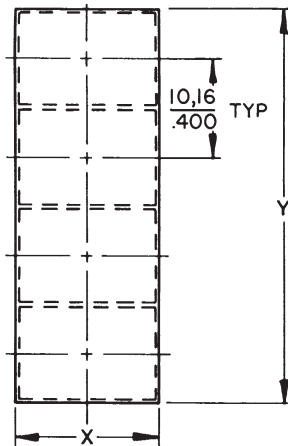

$$\begin{aligned} N &= \text{Number of Switches} \\ Y &= N \times \frac{10.16}{.400} \\ X &= \frac{15.11}{.595} \end{aligned}$$

$$\begin{aligned} \text{Example: } N &= 4 \\ Y &= 4 \times \frac{10.16}{.400} \\ Y &= \frac{40.64}{1.600} \end{aligned}$$

# Manual Switches

## Miniature Manual Line

MML Series

MOUNTING DIMENSIONS (For reference only)

### PANEL CUTOUTS FOR PUSHBUTTON SWITCHES AND INDICATORS/SQUARE TYPE

Individual Snap-in Panel Mount

Individual Printed Wiring Board PWB Mount

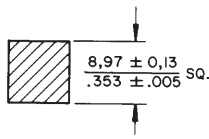
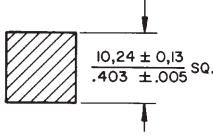
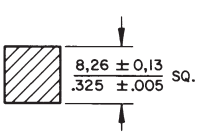
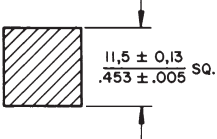

Pushbutton Plunger Thru Panel

Housing Thru Panel

Indicator Lens Thru Panel

See page 77 for panel punch manufacturer.

### MULTI-UNIT PRINTED WIRING BOARD (PWB) MOUNT

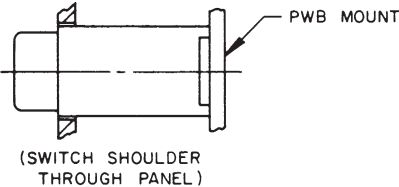

Establish tooling holes on X coordinate and use these holes to establish relationship between PWB and Panel

$$\text{Terminals } \frac{0,20}{.008} \times \frac{0,76}{.030}$$

Recommended hole size in PWB  $\frac{1,17}{.046}$

#### Horizontal Mounting

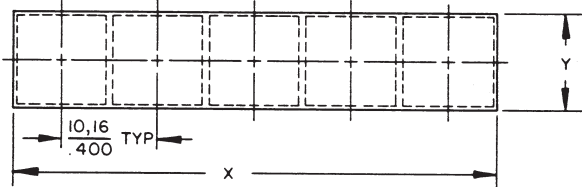

Formula:  
 N = Number of switches  
 $X = N \times \frac{10,16}{.400}$   
 $Y = \frac{10,16}{.400}$

Example: N = 5 Switches  
 $X = 5 \times \frac{10,16}{.400}$   
 $X = \frac{50,80}{2.00}$

#### Vertical Mounting

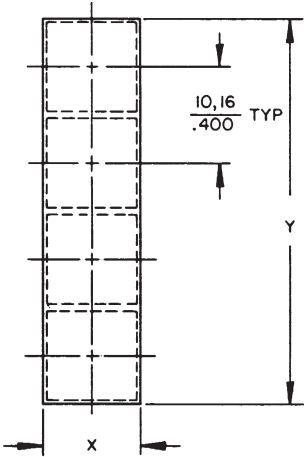

N = Number of Switches  
 Formula:  $Y = N \times \frac{10,16}{.400}$   
 $X = \frac{10,16}{.400}$   
 Example: N = 4  
 $Y = 4 \times \frac{10,16}{.400}$   
 $Y = \frac{40,64}{1.600}$

# Manual Switches

## Miniature Manual Line

MOUNTING DIMENSIONS (For reference only)

### PRINTED WIRING BOARD MOUNT PUSHBUTTON SWITCHES/RECTANGULAR TYPE

#### MML11 Switches

#### PWB Pin Locations

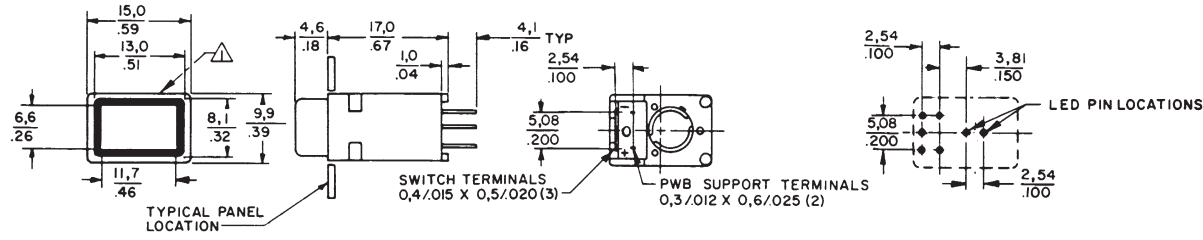

#### PWB Receptacle Installed (LED or Incandescent Lamp)

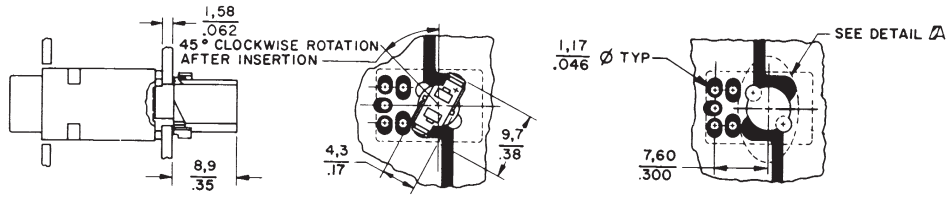

#### MML21 Switches

#### PWB Pin Locations

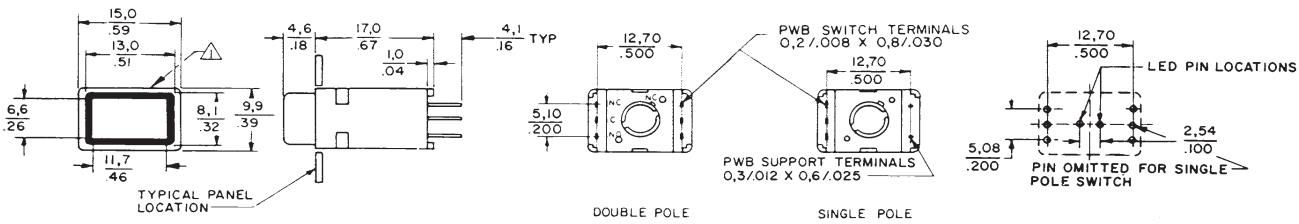

#### PWB Receptacle Installed (LED or Incandescent Lamp)

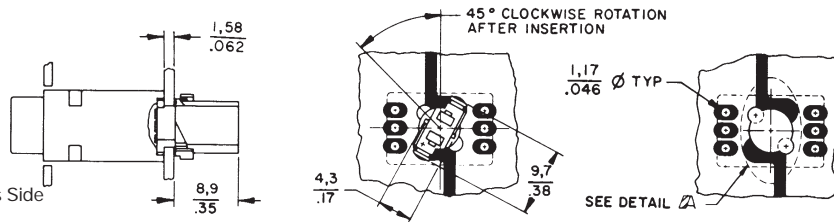

Notes:

△ MICRO SWITCH Identification This Side  
 2 - Linear measure mm/IN. or  $\frac{\text{mm}}{\text{IN.}}$

#### MML31 Switches

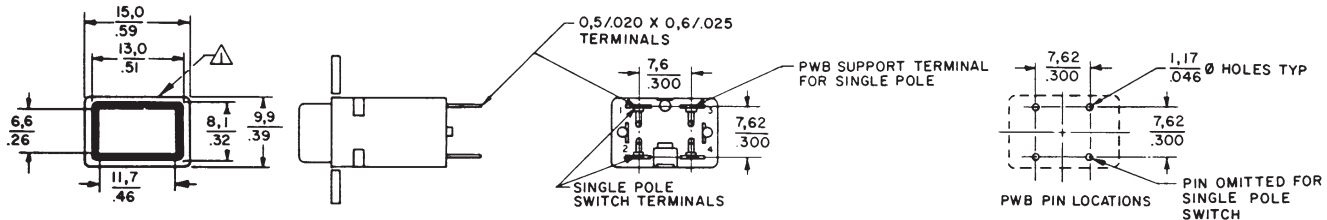

Manuals

# Manual Switches

## Miniature Manual Line

MML Series

MOUNTING DIMENSIONS (For reference only)

PRINTED WIRING BOARD MOUNT INDICATORS/RECTANGULAR TYPE

MML41 Indicators

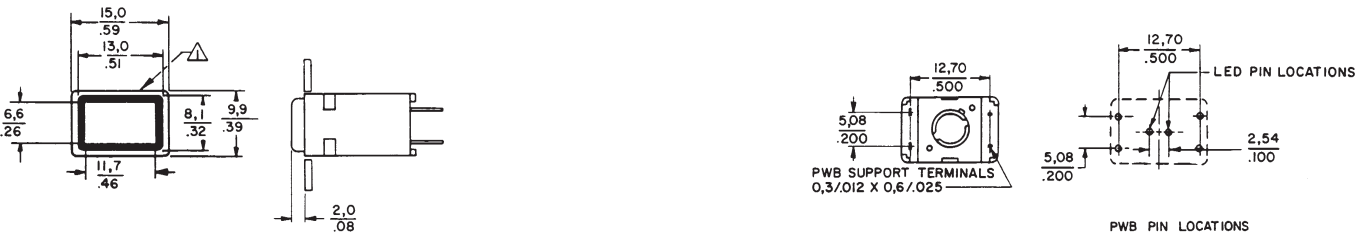

PWB Receptacle Installed (LED or Incandescent Lamp)

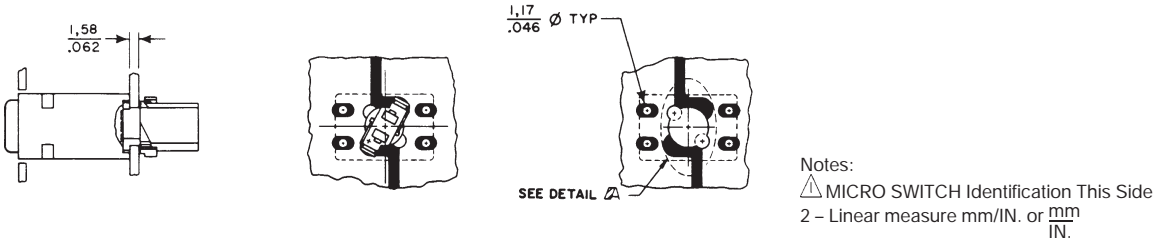

MML46 Indicators

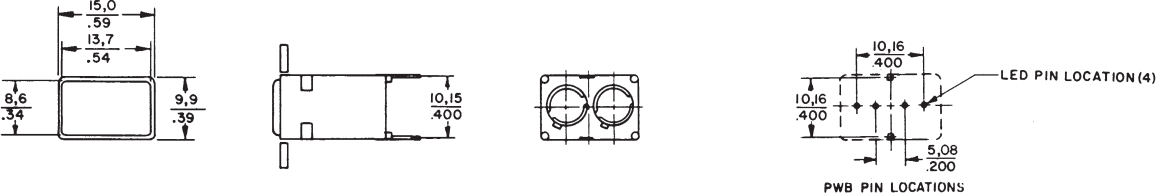

PWB Receptacle Installed (LED or Incandescent Lamp)

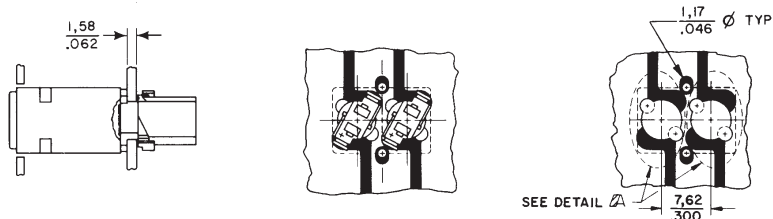

PWB Pad Location For Receptacle (LED or Incandescent Lamp)

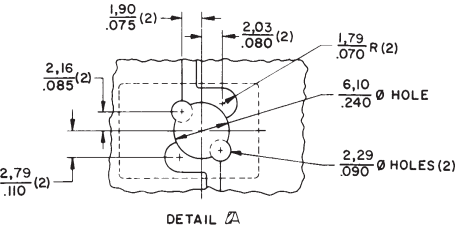

# Manual Switches

## Miniature Manual Line

MOUNTING DIMENSIONS (For reference only)

### PANEL MOUNT PUSHBUTTON SWITCHES/RECTANGULAR TYPE

#### MML21 Switches

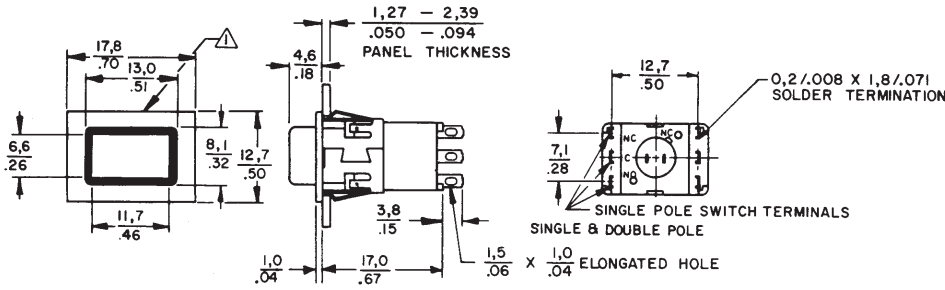

#### Solder Receptacle Installed (LED or Incandescent Lamp)

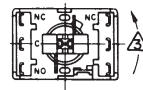
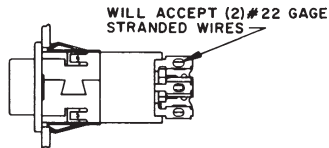

Notes:

- △ MICRO SWITCH Identification This Side
- 2 - Linear measure mm/IN. or  $\frac{mm}{IN}$ .
- ⊗ Rotate 45° counter clockwise for removal from switch or indicator

#### MML31 Switches

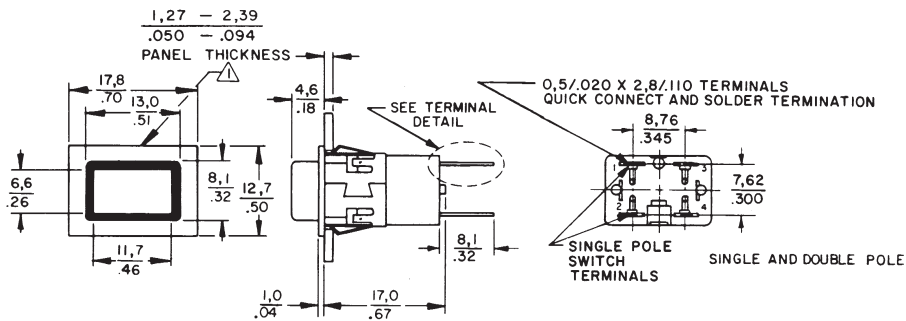

#### Terminal Detail

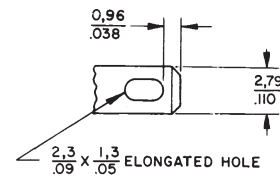

Manuals

# Manual Switches

## Miniature Manual Line

MOUNTING DIMENSIONS (For reference only)

### PANEL MOUNT INDICATORS/RECTANGULAR TYPE

#### MML41 Indicators

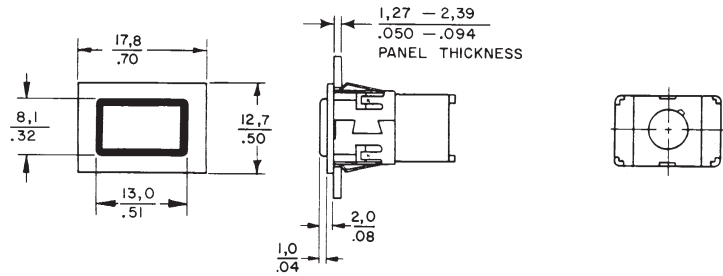

Solder Receptacle Installed (LED or Incandescent Lamp)

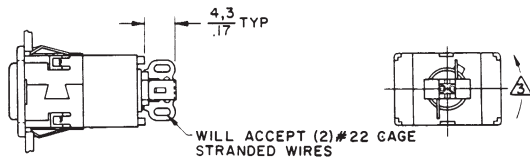

#### MML43 Indicators

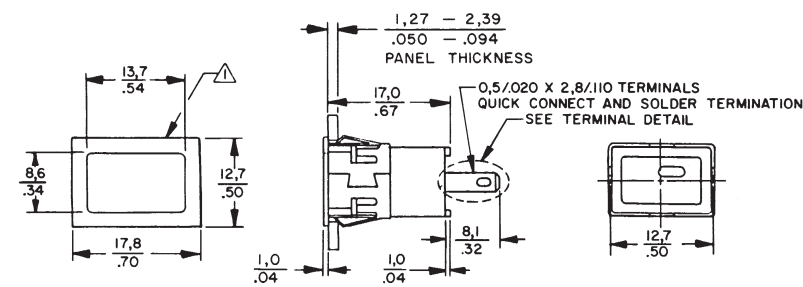

#### Terminal Detail

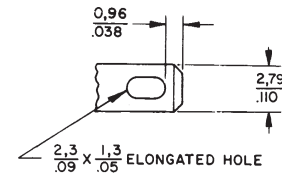

Notes:  
 △ MICRO SWITCH Identification This Side  
 2 - Linear measure mm/IN. or  $\frac{mm}{IN}$ .

#### MML46 Indicators

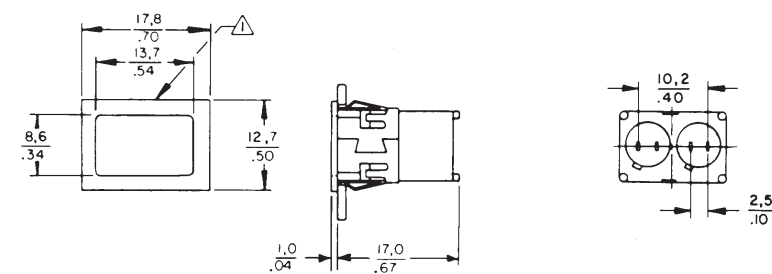

Solder Receptacle Installed (LED or Incandescent Lamp)

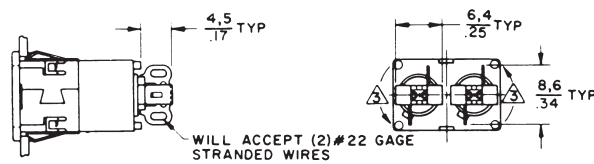

# Manual Switches

## Miniature Manual Line

MOUNTING DIMENSIONS (For reference only)

### PRINTED WIRING BOARD MOUNT PUSHBUTTON SWITCHES AND INDICATORS/SQUARE TYPE

#### MML21 Switches

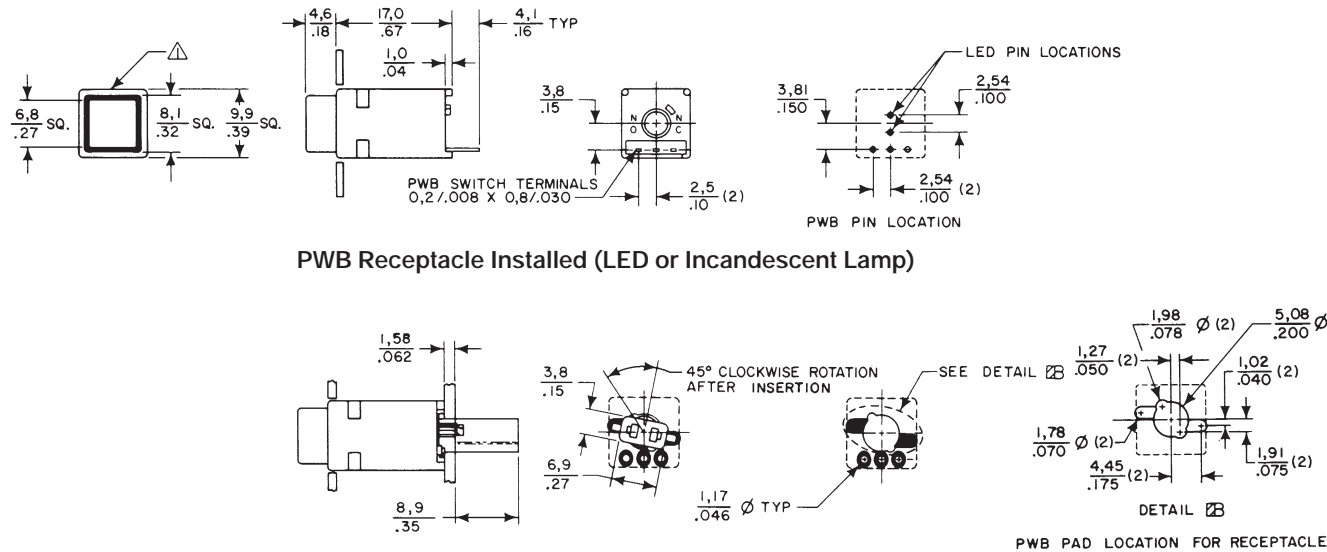

#### MML46 Indicators

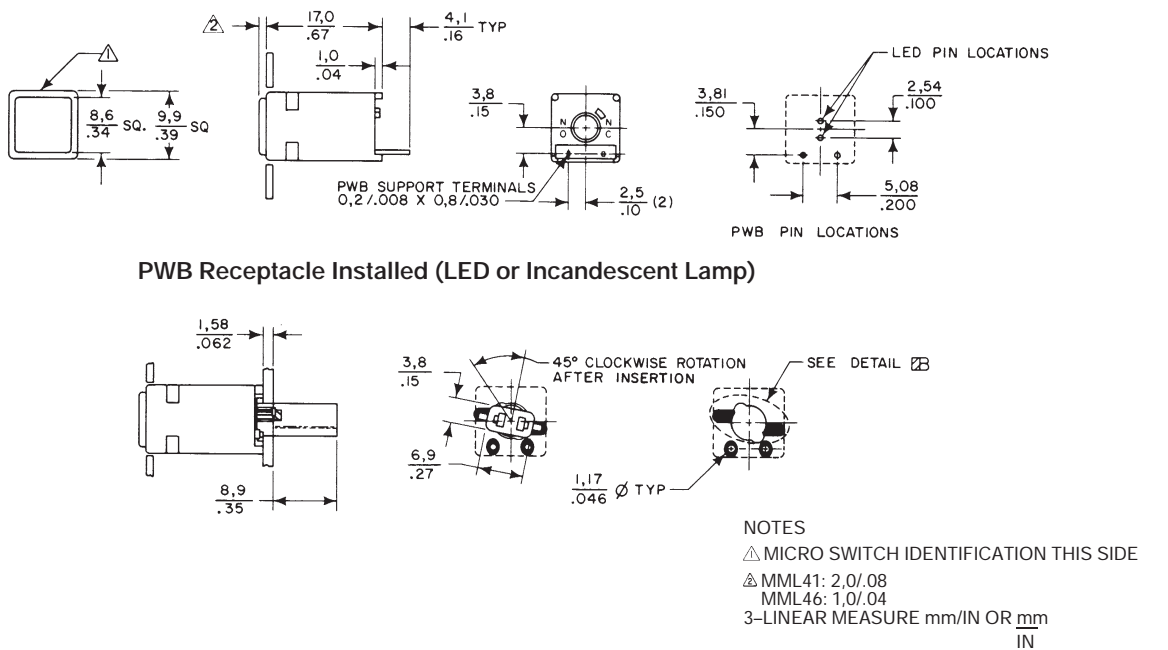

Manuals

### PANEL MOUNT PUSHBUTTON SWITCHES/SQUARE TYPE

#### MML21 Switches

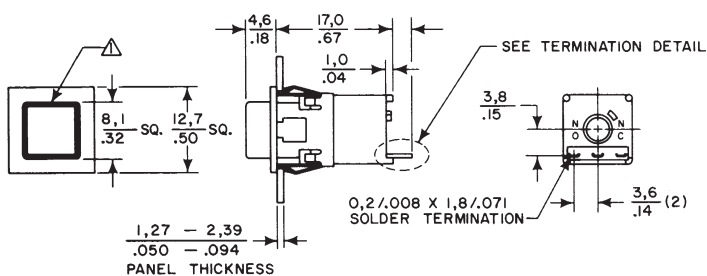

#### Termination Detail

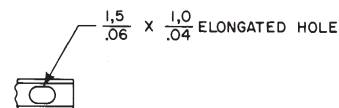

NOTE:  
To install LED or lamp, use MML93L receptacle shown on page 76.

# Manual Switches

## Miniature Manual Line

MOUNTING DIMENSIONS (For reference only)

### LENSES

#### Rectangular Pushbutton Lens

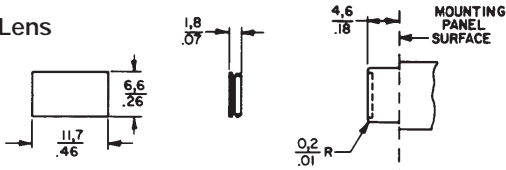

#### Rectangular Indicator Lens

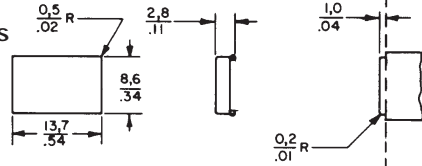

#### Square Pushbutton Lens

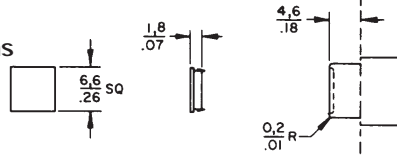

#### Square Indicator Lens

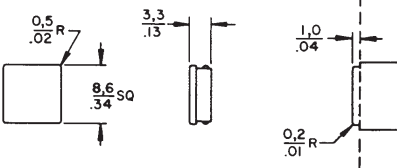

### PWB SUPPORT BRACKETS

#### Rectangular

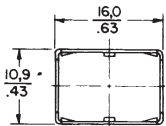

#### Square

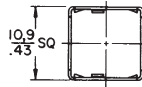

MML SERIES SWITCH TYP

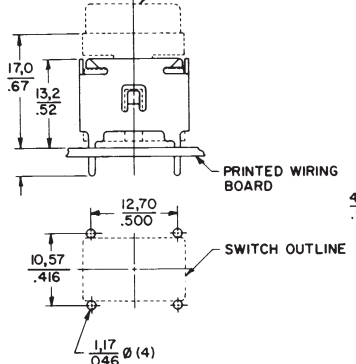

RECOMENDED PRINTED WIRING BOARD LAYOUT

MML SERIES SWITCH TYP

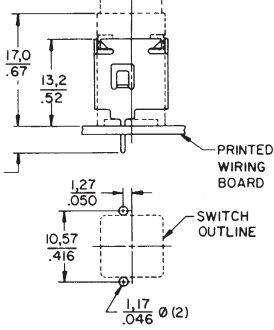

RECOMENDED PRINTED WIRING BOARD LAYOUT



# Manual Switches

## Miniature Manual Line

MML Series

MOUNTING DIMENSIONS (For reference only)

### PANEL CUTOUTS FOR PWB MOUNT PADDLE AND ROCKER SWITCHES

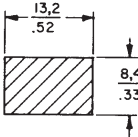

Actuator Thru Panel

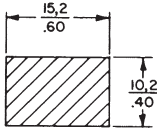

Housing Thru Panel

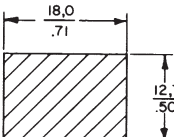

2-Pole MML33, 34 Actuator

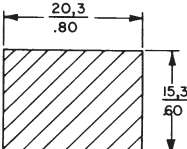

2-Pole MML33, 34 Thru Panel

Housing Thru Panel

See page 77 for panel punch manufacturer.

### MML24 Rocker Switches

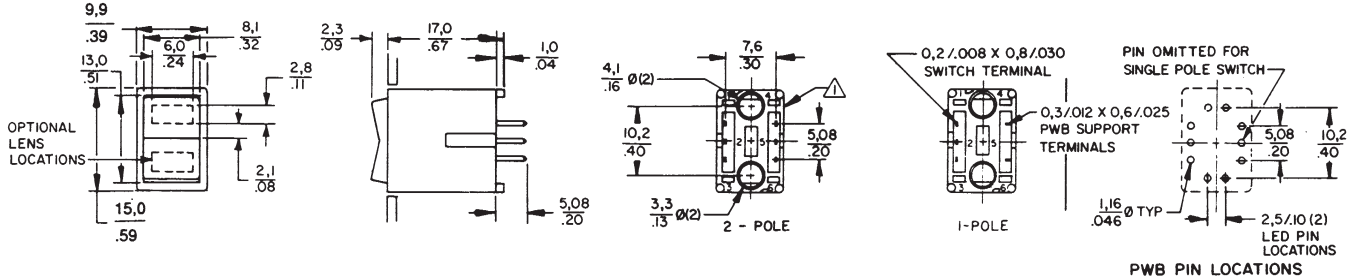

With PWB Receptacle Installed (LED or Incandescent Lamp)

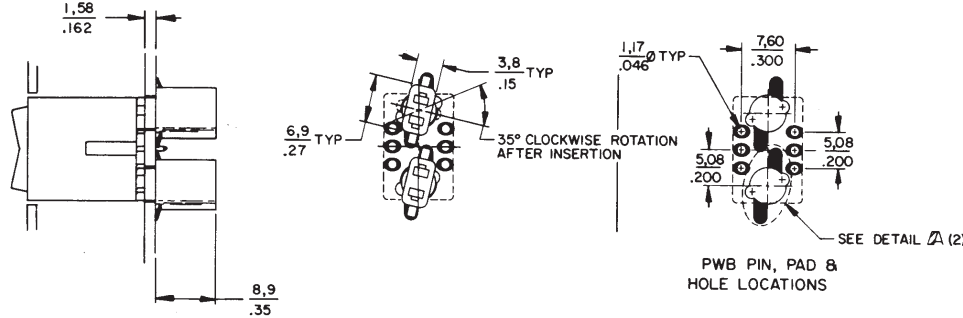

Notes:  
 △ MICRO SWITCH Identification This Side  
 2 - Linear measure mm/IN. or  $\frac{mm}{IN}$ .

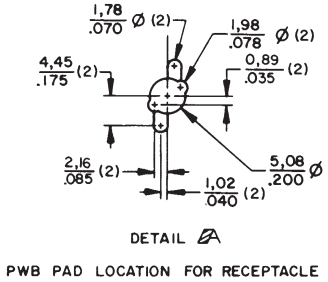

Manuals

# Manual Switches

## Miniature Manual Line

MML Series

MOUNTING DIMENSIONS (For reference only)

### PANEL MOUNT ROCKER SWITCHES

#### MML24 Rocker Switches

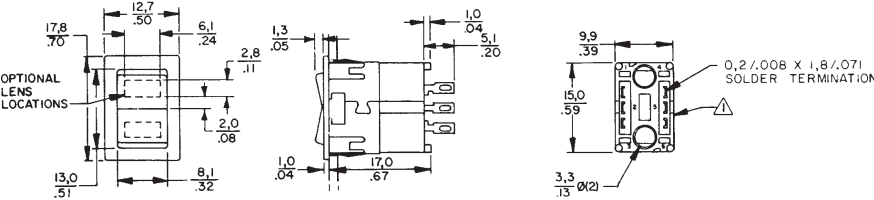

Notes:  
 △ MICRO SWITCH Identification This Side  
 2 – Linear measure mm/IN. or  $\frac{mm}{IN}$ .

NOTE:  
 To install LED or lamp, use MML93R receptacle shown on page 75.

## Данный компонент на территории Российской Федерации

### Вы можете приобрести в компании MosChip.

Для оперативного оформления запроса Вам необходимо перейти по данной ссылке:

<http://moschip.ru/get-element>

Вы можете разместить у нас заказ для любого Вашего проекта, будь то серийное производство или разработка единичного прибора.

В нашем ассортименте представлены ведущие мировые производители активных и пассивных электронных компонентов.

Нашей специализацией является поставка электронной компонентной базы двойного назначения, продукции таких производителей как XILINX, Intel (ex.ALTERA), Vicor, Microchip, Texas Instruments, Analog Devices, Mini-Circuits, Amphenol, Glenair.

Сотрудничество с глобальными дистрибьюторами электронных компонентов, предоставляет возможность заказывать и получать с международных складов практически любой перечень компонентов в оптимальные для Вас сроки.

На всех этапах разработки и производства наши партнеры могут получить квалифицированную поддержку опытных инженеров.

Система менеджмента качества компании отвечает требованиям в соответствии с ГОСТ Р ИСО 9001, ГОСТ РВ 0015-002 и ЭС РД 009

### Офис по работе с юридическими лицами:

105318, г.Москва, ул.Щербаковская д.3, офис 1107, 1118, ДЦ «Щербаковский»

Телефон: +7 495 668-12-70 (многоканальный)

Факс: +7 495 668-12-70 (доб.304)

E-mail: [info@moschip.ru](mailto:info@moschip.ru)

Skype отдела продаж:

moschip.ru

moschip.ru\_4

moschip.ru\_6

moschip.ru\_9